

User's Guide

for

ISTEC *easy*

ISTEC *home*

ISTEC *office*

Table of Contents

1 Introduction	7
1.1 Product Description.....	7
1.2 Features of the ISTECS Telecommunication Systems.....	9
1.3 Package Contents.....	11
1.4 Safety Considerations	12
2 Installing the ISTECS System.....	13
2.1 Safety Considerations	13
2.2 Environmental Requirements for the ISTECS System.....	14
2.3 Connecting the ISTECS System.....	15
2.3.1 Preface.....	15
2.3.2 Connection to a multiple device access line.....	16
2.3.3 Connection on a PBX access line	17
2.4 Mounting the ISTECS System.....	18
2.4.1 Preparations	18
2.4.2 Mounting the ISTECS system	19
2.4.3 Connecting the analogue terminals.....	21
2.4.4 Connecting the door intercom (<i>ISTECS office</i> only).....	23
2.4.5 Final Checks.....	24
3 System Setup.....	25
3.1 Factory Settings.....	25
3.2 Selecting the ISDN Protocol (<i>ISTECS office</i> only)	26
3.3 Function Test	27
3.3.1 Checking the basic functions	27
3.3.2 A quick test of the ISTECS system in the ISDN Multiple Device Access mode.....	27
3.4 Selecting the ISDN Mode PBX ACCESS.....	28

4 Installing and Starting the PC Configuration Program (not <i>ISTEC easy</i> or <i>ISTEC home</i>)	29
4.1 Preface	29
4.2 System Prerequisites	29
4.2.1 Hardware	29
4.2.2 Software	30
4.3 Installing the PC Program on the Hard Disk	30
4.3.1 Installing program version V 1.8	30
4.3.2 Installing program version V 2.0 under Windows 3.11	31
4.3.3 Installing program version V 2.0 under Windows 95.....	31
4.4 Starting the PC Configuration Program	32
5 Operating Your ISTECS System - Notes.....	33
5.1 Tone Dialling (DTMF)	33
5.2 Pulse Dialling.....	33
5.3 Overvoltage Protection	34
5.4 Power Outage.....	34
5.5 Operating Fax Machines and FAX-TAMs.....	34
5.6 Operating Analogue Modems.....	34
5.7 Operator Position	34
6 Operating the ISTECS Systems.....	36
6.1 Introduction.....	36
6.2 Explanation of the Pictograms	37
6.3 Internal Calls.....	38
6.4 External Calls	39
6.4.1 External calls with the <i>ISTEC office</i>	39
6.4.2 Direct trunk access / External calls with the <i>ISTEC easy/home</i>	39
6.5 Speed Dialling (<i>ISTEC office</i> only)	40

- 6.6 PICK-UP 41
- 6.7 Collective Call..... 42
- 6.8 Consultation Hold..... 42
- 6.9 Forwarding an External Call - with announcement..... 43
- 6.10 Forwarding an External Call - without announcement..... 44
- 6.11 Retrieving an Internally Forwarded Call..... 44
 - 6.11.1 Option 1: You have not yet hung up 44
 - 6.11.2 Option 2 (*ISTEC office* - only): You have already hung up 44
- 6.12 Three-party Conference (*ISTEC office* - only)..... 45
 - 6.12.1 Setup a three-party conference..... 45
 - 6.12.2 Disconnect a three-party conference..... 45
- 6.13 Broker 46
- 6.14 Call Waiting 47
 - 6.14.1 Preface..... 47
 - 6.14.2 Special case - consultation hold:..... 47
 - 6.14.3 End your current call and take the waiting call: 48
 - 6.14.4 Broker (internal and external calls):..... 48
- 6.15 Internal Conference..... 49
- 6.16 Auto Call (*SW 2.0 and higher*)..... 50
- 6.17 Call Restrictor (*SW 2.0 and higher*) 51
- 6.18 The Door Intercom (*ISTEC office* - only)..... 52
 - 6.18.1 You hear the door bell and wish to dial the door intercom..... 52
 - 6.18.2 You wish to open the door (while connected with the intercom) ... 52
 - 6.18.3 During an external call, you wish to dial the door intercom..... 52
- 6.19 Alarm Call (*ISTEC office* - only, *SW 2.0 and higher*)..... 53
- 6.20 Executing a RESET from a Telephone 53

7 Configuration from a Telephone	54
7.1 Preface	54
7.2 Begin the Configuration.....	54
7.3 Features	55
7.3.1 Setting the ISDN mode	55
7.3.2 Multiple Subscriber Number.....	55
7.3.3 Entering the central number.....	55
7.3.4 Music-on-Hold	55
7.3.5 Day / night configuration (<i>ISTEC office</i> - only)	56
7.3.6 Call waiting.....	56
7.3.7 Multi-Function-Memory (<i>ISTEC office</i> - only)	57
7.3.8 Speed dialling (<i>ISTEC office</i> - only)	58
7.3.9 <i>Call restrictor</i> (<i>ISTEC office</i> - only).....	58
7.3.10 Auto Call (<i>ISTEC office</i> - only)	59
7.3.11 Assigning a ringing sequence to the calling number (<i>ISTEC office</i> - only).....	59
7.3.12 Changing the PIN of extension 21 (Config-PIN)	59
7.3.13 Alarm call (<i>ISTEC office</i> - only).....	60
8 If something doesn't function.....	70
8.1 Malfunctions	70
8.2 Initialising the <i>ISTEC</i> System to the Factory Settings.....	73
8.3 Important Service Numbers	74
8.4 Modem Settings for the Emmerich Mailbox.....	75
9 Technical Appendix.....	76
9.1 Call Number Plan.....	76
9.2 Audible Tones and Ringing Signals (Summary).....	77
9.3 Connections / Terminal Strip (<i>ISTEC 1008</i>).....	78

9.4 Technical Specifications	79
10 Glossary	81

1 Introduction

1.1 Product Description

The *ISTEC easy*, *ISTEC home* and *ISTEC office* are ISDN telecommunication systems that deliver a broad spectrum of features while remaining easy to use. The ISTEC private exchanges provide an economical access to the ISDN telecommunication network, since they enable you to continue to use your existing analogue terminal equipment and internal communication structure. It is not necessary to purchase expensive new cables or special ISDN terminals.

You can connect any certified analogue terminal to your ISTEC telecommunication system that meets the technical specifications given in chapter 9.4. Among others, these include the following analogue terminals:

- Telephone
- Group 3 fax machines
- Answering machines
- Modem (up to 33,600 bit/s)

The ISTEC telecommunication systems vary in the number of terminals and options that they support as well as in the supplied software (see table 1.1-1). They also differ in their sets of features (chapter 1.2) and the contents of the standard package.

Interface / Software	ISTEC easy	ISTEC home	ISTEC office
ISDN Basic Rate Interface	1	1	1
PC Serial Interface (RS 232c)	---	1	1
Analogue terminals	3	6	8
Door intercom with door opener	---	---	1
PBX software version	1.97TA	1.97TA	2.1
PC configuration program software version	---	---	2.1

Table 1.1-1

Note: Please note that on the ISTEC telephone exchanges the internal extension numbers are fixed. If you wish to operate your ISTEC system on an ISDN line set up for the ISDN PBX mode, you must enter these extension numbers in your order for the ISDN access.

The internal extensions are assigned as follows:

ISTEC easy: 21 to 23

ISTEC home: 21 to 26

ISTEC office: 21 to 28

Operator position: 0

1.2 Features of the ISTEK Telecommunication Systems

Feature	ISTEC easy	ISTEC home	ISTEC office
ISDN MODE MULTIPLE DEVICE ACCESS	●	●	●
ISDN MODE PBX ACCESS	●	●	●
ISDN Protocol 1TR6	---	---	●
ISDN Protocol DSS1	●	●	●
Connect terminals with DTMF dialling	●	●	●
Connect terminals with pulse dialling	---	---	●
Different signalling for external and internal calls as well as for the door intercom	●	●	●
Special signalling	---	---	●
External calls	●	●	●
Internal calls	●	●	●
Message-on-Hold	●	●	●
Music-on-Hold	---	●	●
Call metering / administration on PC	---	---	●
Meter pulse to the terminal equipment	---	●	●
Direct trunk access (● selectable, ○ fixed)	○	○	●
Speed dialling	---	---	●
Collective call	●	●	●
Pick-up from answering machine	●	●	●
Consultation hold	●	●	●
Call transfer (internal)	●	●	●
Call transfer without announcement (call transfer)	●	●	●
3 party conference (2 internal, 1 external)	---	---	●
ISDN broker (1 B-channel, on a MULTIPLE DEVICE ACCESS)	●	●	●
Broker (2 B-channels, on a PBX ACCESS))	●	●	●
Call waiting	●	●	●
Call waiting block	●	●	●
Call forwarding immediate (internal, external)	●	●	●
Call forwarding when busy (internal)	---	---	●

Feature	ISTEC easy	ISTEC home	ISTEC office
Call forwarding after n-rings (internal)	---	---	●
Internal conference	●	●	●
Auto call	---	---	●
Call restrictor	---	---	●
Communication with the door intercom	---	---	●
Alarm call	---	---	●
Day / night switching (manual)	---	---	●
Speed dialling memory (60 destinations)	---	---	●
Reset from telephone	●	●	●
Configuration with a PC	---	---	●
Configuration from a telephone	●	●	●
Class of service (5 classes), freely selected for each extension	●	●	●
Service identifier freely selected for each extension	●	●	●

1.3 Package Contents

The following are included in the standard ISTEK packages:

Item	ISTEK easy	ISTEK home	ISTEK office
PBX	●	●	●
Cable to connect to the ISDN line	●	●	●
Cable to connect to the PC	---	---	●
Configuration program on a 3.5 " diskette for PC	---	---	●
Manual for the configuration program on a 3.5 " diskette	---	---	●
Acrobat-Reader on a 3.5 " diskette	---	---	●
Installation and operation manual	●	●	●
Installation material (4 screws, 2 wall plugs)	●	●	●
Drilling template	●	●	●

1.4 Safety Considerations

Your ISTEK telephone system was built and tested using the most modern methods. The systems satisfy the strict European safety regulations. However in spite of all our care, as with any other electrical device (such as televisions, stereo systems, washing machines, etc.), a certain degree of risk cannot be excluded in the operation of the system, since electrical current can be a danger.

Therefore, in the following cases, you should disconnect the ISTEK system from the mains and have it serviced:

- If water or any other fluids have entered the system.
- If the mains power cable or plug has been damaged.
- If, in spite of carefully following the instructions in manual, the ISTEK system does not function properly.
- If the ISTEK system has been dropped or the case is damaged.
- If the ISTEK system obviously deviates from the normal operation.

Proper Usage

Your ISTEK telephone system is only intended for connecting analogue terminal equipment to an ISDN Basic Rate Interface. No other application is proper usage. You should only use the ISTEK telephone system for the functions described in this manual. Improper usage of the system may result in damage requiring extensive and expensive repairs.

No Alterations or Modifications

The ISTEK telecommunication systems may not be modified in construction or safety features without our explicit written agreement.

Any alteration releases Network & Telecommunication Emmerich GmbH from any liability for the resulting damage. In particular, all repairs and soldering on the circuit board are forbidden.

Before opening the ISTEK case, the power supply must be unplugged from the mains!

Qualified Personnel for the Installation and Setup

We recommend that you have the system installed and setup by qualified personnel, since improper installation can result in damage to the ISTEK system and the connected terminal equipment.

The current regulations restrict the location of the installation of the ISTEK system to one on the same property as the ISDN network terminator.

2 Installing the ISTEK System

2.1 Safety Considerations

Before beginning the installation and setup of your ISTEK system, please carefully read the following. The following notes are intended for your own safety and the security of the ISTEK system.

1. During the mounting and installation of the system, observe the VDE 0800 (for telecommunication systems) and VDE 0100 (for high current systems) recommendations or their local equivalent.

Caution: Electrical equipment may only be installed by qualified personnel

2. Select the installation location in accordance with the recommendation in the chapter „Selecting the Installation Location“.
3. When drilling the holes in the wall, take care not to damage any power, water, or gas lines.
4. Do not install the ISTEK system next to a heater or an air conditioner.
5. Make absolutely certain that the ISTEK system power supply is only plugged into a mains outlet with 230-VAC.

2.2 Environmental Requirements for the ISTEK System

- Ventilation:** Do not install the ISTEK system in a tight unventilated cabinet. The ISTEK system could overheat and be destroyed.
- Dust:** The ISTEK system satisfies the recommendations in DIN 40046 Part 47 (The effect of dust and sand). However, you should still not install the ISTEK system in a location where it will be subjected to a large amount of dust (e.g., from sanders, circular saws or band saws).
- Humidity:** The ISTEK system meets the IEC 721 3K6 standard. Never the less, the ISTEK system may not be installed where it will be subjected to high humidity, such as is found in a laundry, in-door swimming pool, or sauna.
- Temperature:** During operation the ambient temperature for the ISTEK system should be between 0 °C and 40 °C. Therefore do not install your ISTEK system in a location where it will be subjected to direct sunlight or extreme cold.

2.3 Connecting the ISTEK System

2.3.1 Preface

You can operate your ISTEK system on a Basic Rate Interface that is setup in either the MULTIPLE DEVICE or PBX mode. The mode of operation for your ISDN Basic Rate Interface is shown in your ISDN contract.

The operation mode of your ISDN Basic Rate Interface determines the number of ISDN terminals that can be connected to your ISDN access.

When operated in the MULTIPLE DEVICE mode, the ISDN Basic Rate Interface supports up to eight ISDN terminals.

When operated in the PBX mode, the ISDN Basic Rate Interface only supports the operation of your ISTEK system.

2.3.2 Connection to a multiple device access line

Prinzipschaltbild

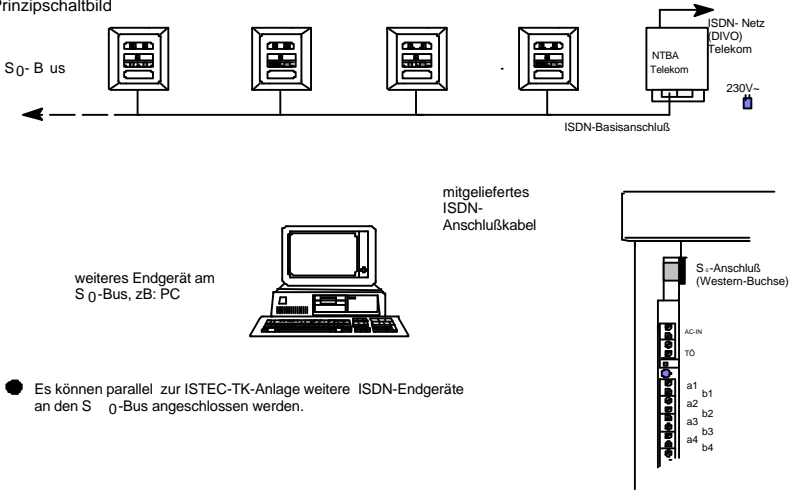

- Es können parallel zur ISTEK-TK-Anlage weitere ISDN-Endgeräte an den S₀-Bus angeschlossen werden.

Installationsplan

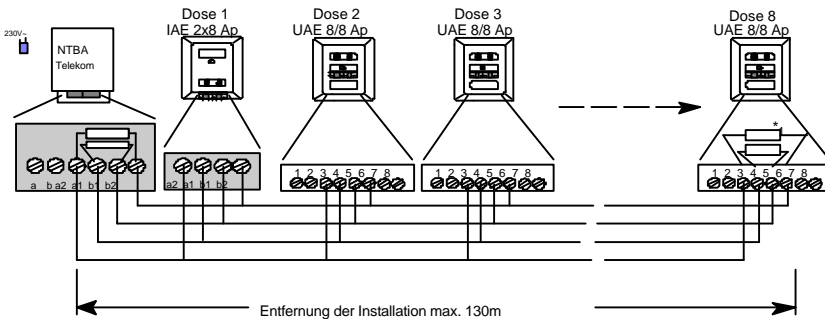

- *1 In der letzten Dose sind im Sende- und im Empfangskreis je ein 100 Ohm Widerstand einzubringen, um den S₀-Bus abzuschließen.

Grundinstallation der Telekom; Dose 1 wird nicht immer installiert

2.3.3 Connection on a PBX access line

Prinzipschaltbild

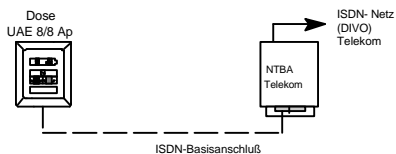

mitgeliefertes
ISDN-
Anschlußkabel

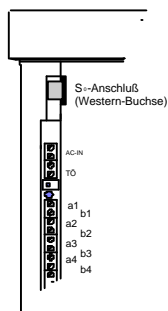

- An den ISDN-Anlagenanschluß kann nur **eine** Nebenstellenanlage (TK-Anlage) angeschlossen werden und somit **keine** weiteren ISDN-Engeräte !
- Die ISTEC-TK-Anlage kann direkt am NTBA oder alternativ über eine ISDN-Dose am NTBA angeschlossen werden.

Installationsplan

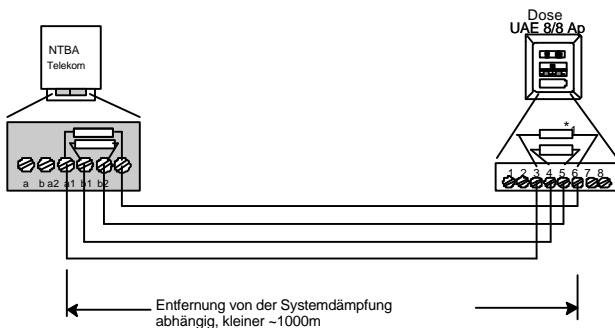

*1 In der Dose sind im Send- und im Empfangskreis je ein 100 Ohm Widerstand einzubringen.

 Grundinstallation der Telekom

2.4 Mounting the ISTEK System

2.4.1 Preparations

1. Do not mount your ISTEK system near equipment with strong magnetic fields, such as large mains transformers, conveyors, elevators, production machines or base stations for cordless phones, etc.
2. Do not lay the telephone cables parallel to power lines over longer distances.
3. When selecting the location to mount the ISTEK system, observe the recommendations given in "2.2

Environmental Requirements for the ISTECS System”.

4. Lay the S₀ Bus cable from the network terminator (NTBA) to the ISTECS system.
5. Lay the telephone cables for each terminal from the ISTECS to the telephone jack and to the door intercom.

2.4.2 Mounting the ISTECS system

- 1. Take care, while marking the location of the holes to be drilled, that you do not hit a power, water or gas line.**
2. Use the enclosed drilling template when marking the holes to be drilled.
3. Drill the holes in the wall and then drive the wall plugs in until they are flush with the wall surface.
4. Turn both screws in until the underside of the screw head is approximately 3.5 mm from the wall.

- Open the ISTE system's snapped-on cover by pressing both thumbs firmly on the ribbed surfaces and pulling the cover toward you.

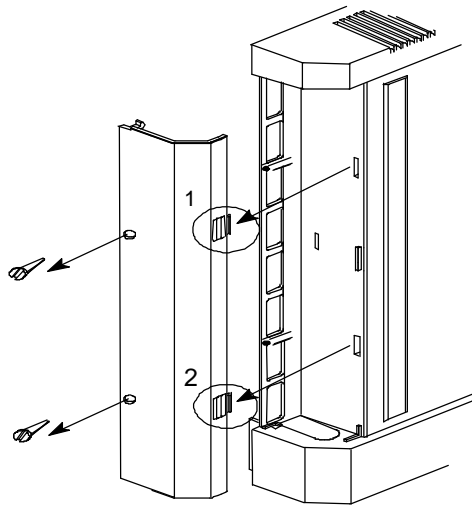

- Pull the ISDN cable from the bottom of the case through the cable guides to the wire terminals.
- Plug the Western plug into the broad Western jack.

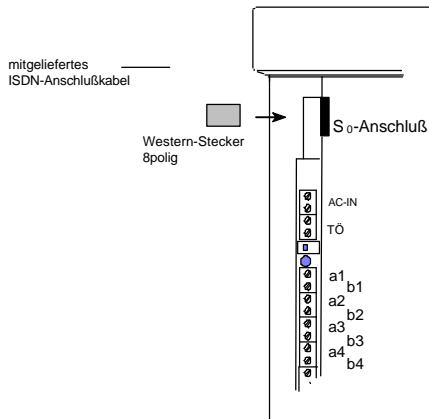

9. Plug the PC cable's Western plug into the smaller Western jack.

10. When hanging the ISTEK system pay attention to the placement of the cables.

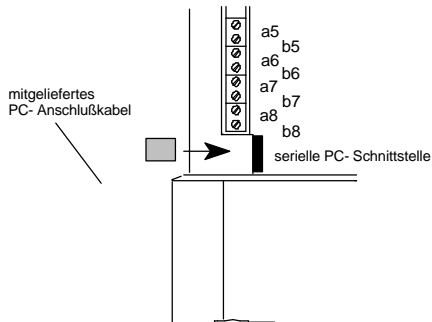

2.4.3 Connecting the analogue terminals

To avoid swapping the a/b wire pairs, connect the telephone cables from the ISTEK system to the telephone jacks by extension.

For the analogue terminals only connect the wire pairs to the screw terminal pairs a1/b1 to a8/b8.

Make certain that none of the wire pairs are connected to different terminal pairs.

Anschluß der analogen Endgeräte

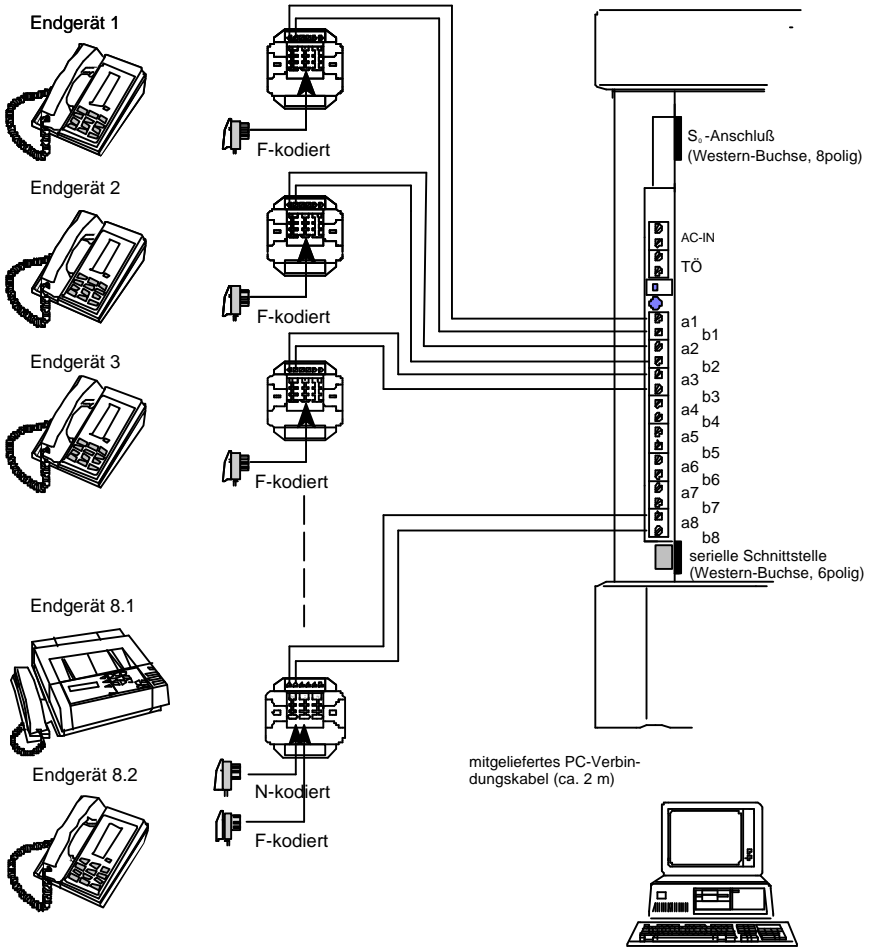

2.4.4 Connecting the door intercom (*ISTEC office only*)

The *ISTEC office* provides direct support for the connection of any door intercom using the standard 2-wire interface -- for example, the Emmerich **Doorphone 1/2**.

If you wish to use a door intercom from another manufacturer (e.g., Siedle, etc.), you will need an optional module.

The **Doorphone 1/2** is connected to the terminal pair TÖ on the *ISTEC office*. The polarity does not matter.

If, in addition to the door intercom, a door opener is also connected, to open the door from a telephone, a bell transformer must be attached. Connect the bell transformer to the terminal pair AC-IN.

Netzgerät

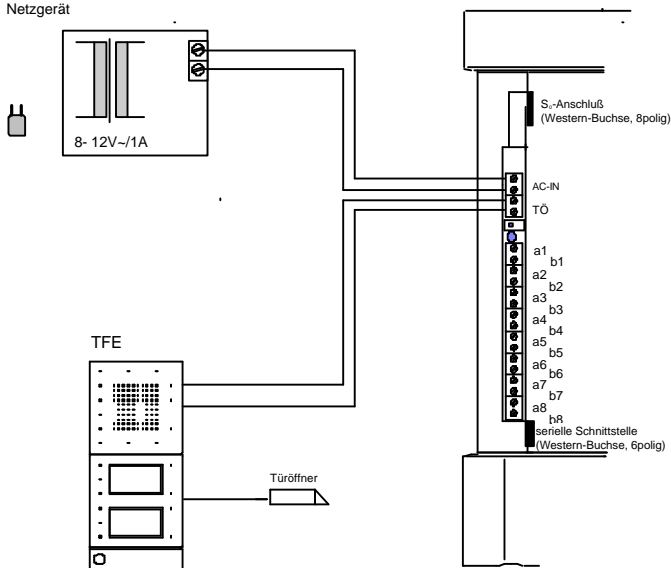

2.4.5 Final Checks

1. Before beginning the setup, examine your installation one more time.
2. Close the cover over the terminal strip and lock it down with the enclosed screws.
3. Plug the serial cable into an appropriate port on your PC.
4. Connect the ISTEK system to the ISDN network.
5. Lastly, plug in the power supply.

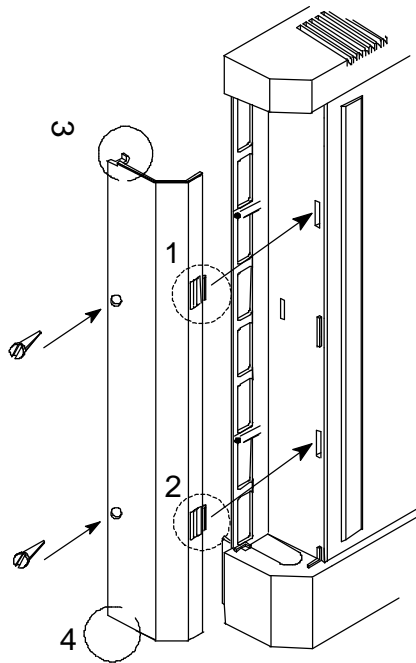

3 System Setup

3.1 Factory Settings

The following table shows the factory settings as the ISTECS system is configured when it is first plugged into the mains.

Function	Setting
ISDN Protocol	DSS1 (Euro-ISDN)
ISDN Mode	Multiple device
Extensions	ISTEC easy: 21 to 23 ISTEC home: 21 to 26 ISTEC office: 21 to 28
Signalling of calls (internal/external)	On all extensions
Signalling of the door intercom (ISTEC office only)	Extension 21 to 28
Pass call metering pulse through	OFF, not ISTECS easy
Music-on-Hold	OFF, not ISTECS easy
Message-on-Hold, extern	OFF
Direct trunk access, ISTEC office	OFF
Direct trunk access, ISTEC easy/home	Permanent for all extensions
Class of service	International (all calls are permitted)
Service identifier	Telephone
PIN	0000 on all extensions
Call waiting	ON
Call transfer	OFF
Alarm call	OFF (only Version 2.0 and higher)
Auto call	OFF (only Version 2.0 and higher)
Call restrictor	OFF (only Version 2.0 and higher)

3.2 Selecting the ISDN Protocol (*ISTEC office only*)

Your ISTEC system is initially set to the European DSS1 ISDN protocol. In Germany, it is also possible to operate the system in the 1TR6 ISDN protocol, to do so you must slide the switch to select this protocol. To select the 1TR6 protocol, open the snap-on cover and slide the DIP switch next to the terminal strip to the „ON“ position.

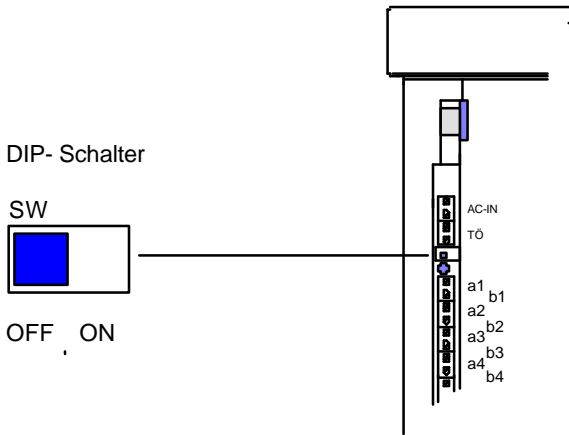

DSS1 protocol (factory setting):
1TR6 protocol (Germany):

SW in „OFF“ position
SW in „ON“ position

After switching the ISDN protocol you must perform a RESET by unplugging the power supply for at least 15 seconds.

3.3 Function Test

3.3.1 Checking the basic functions

After picking up the telephone receiver, you should hear the internal dial tone. If this is not the case, unplug the ISTECS system from the mains and the NTBA. Check your installation again. If you cannot find a mistake, please contact your distributor or call our Hotline (see chapter 8.3).

Check that your ISTECS system can make a connection to each extension and to the door intercom.

To check the connection to the public ISDN network, place an outgoing call from an extension on your ISTECS telephone system via the central exchange back to one of your system's external phone numbers (MSNs). To make this outgoing call, first dial the external line code „0“ and then one of your MSNs (*ISTECS easy/home* without „0“), that you were assigned by your telecom.

3.3.2 A quick test of the ISTECS system in the ISDN Multiple Device Access mode

A quick test of your ISTECS system can only be executed in the ISDN mode - MULTIPLE DEVICE ACCESS.

If you are operating your system in Germany with the 1TR6 ISDN protocol, it is enough to make a call to the EAZ „0“. All of the connected telephones will ring in cycles of groups of two.

If your system is using the DSS1 ISDN protocol (Euro-ISDN) dial on of the MSNs for your ISTECS system. The connected telephones will then ring in pairs.

- Group 1: Extension 21 and 25
- Group 2: Extension 24 and 28
- Group 3: Extension 23 and 28
- Group 4: Extension 22 and 26

3.4 Selecting the ISDN Mode PBX ACCESS

If you have ordered a PBX access from your network operator (e.g., your local telecom), you must set your ISTEK system to the ISDN mode PBX ACCESS.

Action	Result
1. Pick up the telephone receiver	internal dial tone
2. Enter the digits „8“, „1“	wait for acknowledging tone
3. Enter the digits „0“, „0“, „0“, „0“	wait for acknowledging tone
4. Enter the digits „0“, „0“, „2“	wait for acknowledging tone after each digit
5. Hang up the telephone receiver	

Note: Network & Telekommunikation Emmerich GmbH does not guarantee full support of the ISDN mode PBX ACCESS by the ISTEK system.

4 Installing and Starting the PC Configuration Program (not *ISTEC easy* or *ISTEC home*)

4.1 Preface

On the enclosed diskette, you will find a program package to configure your ISTECS system (not *ISTEC easy* or *ISTEC home*). With this program package, you can select the various features of your ISTECS system and administer the call charges.

Although the programs are easy to use, they still assume a small degree of experience in the use of a PC.

Before beginning the installation of the PC software please read the following notes:

- Make a backup copy of the enclosed diskette.
- Only work with the backup copy.
- Read the latest information in the file LIESMICH (READ.ME).

4.2 System Prerequisites

4.2.1 Hardware

100% IBM compatible PC with:

- 3.5 " diskette drive
- 512 kB memory
- VGA graphic card
- serial interface (RS232c, Sub-D plug, 9-pin)

Further we recommend a hard disk drive and a mouse as well as an additional serial or parallel port to connect a printer.

Note: When connecting the serial cable to your ISTECS system observe the safety notes in sections 1.4 and 2.1.

4.2.2 Software

Version V 1.8: MS-DOS, Version 3.1 or higher
from Version V 2.0: Windows 3.1 or higher

4.3 Installing the PC Program on the Hard Disk

4.3.1 Installing program version V 1.8

The installation is done on the DOS level. Proceed as follows:

1. Insert the program diskette in the diskette drive.
2. Switch to the diskette drive.
C:\> A:
3. Enter the command **INSTALL**, and press the RETURN key.
4. Follow the program's instructions.

If you wish to overwrite an older version of the configuration program, you must answer the "are you sure?" by entering „J“ ("Y") and pressing the RETURN key.

The program will now be written to drive **C** in the directory **ISTEC** (C:\ISTEC).

Note: If you wish to run the PC configuration program under MS-Windows, you must first create a new program group under Windows.

If your mouse is connected to the serial port COM1, you must use another serial port to connect your ISTEK system.

4.3.2 Installing program version V 2.0 under Windows 3.11

Beginning with Version 2.0, the PC configuration program **ISTECWIN.EXE** is only available in a Windows version. To install it, proceed as follows:

1. Insert the program diskette „**ISTEC Top Features - Release 2.0** -“ in the diskette drive.
2. In the Program Manager, select the menu point „*Run...*“.
3. Click on the button **Browse**, and switch to the diskette drive **A**.
4. Double click in the command-line on the program **SETUP.EXE**.
5. Click on the button **OK**.
6. Now follow the instructions of the Setup program.

4.3.3 Installing program version V 2.0 under Windows 95

You can also install the PC configuration program **ISTECWIN.EXE** under Windows 95. To do so, proceed as follows:

1. Insert the program diskette „**ISTEC Top Features - Release 2.0** -“ in the diskette drive.
2. On the Windows desktop double click on the icon “My Computer”.
3. Click on the icon for the diskette drive.
4. Double click on the program **SETUP.EXE** to start it.
5. Now follow the instructions of the Setup program.

Note: To create a link between the desktop and the program group, drag the program icon for the PC configuration program from the program group to the desktop.

4.4 Starting the PC Configuration Program

Version V 2.0 of the PC configuration program is started in the same manner as any other Windows program -- simply double click on its icon.

With Version V 1.8, you have two possibilities to start the program:

1. Under MS-DOS:

- switch to the directory in which the program is found
- enter the command **ISTEC**
C:\ISTEC>ISTEC
- and press RETURN

2. Under MS-Windows:

- double click on the program's icon.

5 Operating Your ISTECS System - Notes

5.1 Tone Dialling (DTMF)

To your ISTECS telecommunication system, you can connect any analogue telephone with DTMF tone dialling, which has the R button implemented as a Flash button (flash time: 80 ms +/- 30 ms).

Your ISTECS telecommunication system does not support implementation of the R button as an earth button.

The Flash button is used to setup another call. If another number is not dialled within 10 seconds after the Flash button is pressed, you will be reconnected with the party you placed on hold.

5.2 Pulse Dialling

You can also use pulse dialling telephones on your **ISTECS office**. You access the desired features by dialling the corresponding digits. The Flash button is not used.

The **ISTECS home** can be upgraded to support pulse dialling by purchasing the **ISTECS Top Features** software package. The **ISTECS easy** cannot be upgraded to support pulse dialling.

Due to technical reasons using a dial telephone may result in dialling wrong numbers. Therefore, you should not connect dial telephones to your ISTECS telecommunication system.

5.3 Overvoltage Protection

Your ISTEK telecommunication system has a limited degree of overvoltage (e.g., lightning) protection on the S₀ bus side. During lightning storms you should unplug the cable to the NTBA's S₀ bus or have a conventional overvoltage protection installed on your ISDN line.

5.4 Power Outage

In the case of a power outage, any existing calls will be interrupted. The ISTEK telecommunication system's programmed configuration will be retained. The charges incurred in the hour prior to the power outage will be deleted.

5.5 Operating Fax Machines and FAX-TAMs

Call waiting is activated in the factory settings for all ISTEK telecommunication systems. This can result in disturbances when sending a fax and can also break the connection. Therefore, on the extension on which you wish to use a fax, you should switch off *call waiting* or select the service identifier **Combi port**.

5.6 Operating Analogue Modems

The ISTEK telecommunication systems support the operation of modems with a transfer rate of up to 33600 bit/s. However, this transfer rate cannot be guaranteed for external data links, since the transfer rate depends on the quality of the line between the ISDN exchange and the modem that receives or sends the data.

Please make certain that your modem is set to tone dialling.

In entering the number to be dialled insert a pause of about 3 seconds between the external line code „0“ and the number to be called -- see your modem's manual for details. If the pause is not used, erroneous connections may result.

5.7 Operator Position

If you operate your ISTEK telecommunication system in the ISDN mode PBX ACCESS, callers can reach a so-called operator position by dialling the extension „0“.

An operator position is generally a central receptionist for all external callers. This person can then connect the callers to the desired party.

During the call transfer phase, the operator position is blocked for another incoming call. Your ISTEK telecommunication system permits assigning two extensions (extension 21 to 28) as first and second operator positions. In this manner, you can handle two incoming calls.

If you assign one or both of the operator positions to the door intercom, visitors will be signalled at the operator position when they press the doorbell button. Details regarding the operation of the door intercom can be found in section 6.18.

Note: If one of the operator positions is programmed with an external call transfer, all calls to extension „0“ will be transferred to the programmed number.

6 Operating the ISTEK Systems

6.1 Introduction

This chapter shows you how to use the various features of your ISTEK system with your analogue telephones. This introduction is intended to help you better understand the following procedures. The procedures are explained in tables, which consist of the two columns „**Action**“ and „**Result**“.

The left column „**Action**“ describes both the events that occur on your extension as well as the instructions that you must follow in order to execute the desired function.

The right column „**Result**“ describes what happens when you follow the instructions in the column „**Action**“ (see Table 6.1-1).



Action	Result
 This happens on your extension (e.g., ringing).	
 You perform this action (e.g., pick up the receiver).	This is what happens, when you have performed the action (e.g., connection with the caller).

Table 6.1-1

Note: The **ISTEK office** and **ISTEK easy/home** systems are delivered with different software versions. With many of the features this results in different procedures on the telephones. For this reason in the following the different procedures used with **ISTEK office** and **ISTEK easy/home** are described separately.

If you enable direct trunk access for an extension on your **ISTEK office**, on this extension the various features will be accessed in the same manner as on the **ISTEK easy/home**

6.2 Explanation of the Pictograms

The pictograms in the left column have following meaning:



Pick up the receiver



Speak with your party



Hang up the receiver



Enter the call number or the code number(s)



Enter a digit „0“ ... „9“



Press the flash (R) button



Press the # button







Telephone rings

The tones and ringing signals are summarized in section 9.2.

6.3 Internal Calls

With your *ISTEC* system you can make an internal call between two extensions. The extensions are dialled with a two digit call number.





Action	Result
 Pick up the receiver	dial tone *
 Press flash button, only with <i>ISTEC easy/home</i>	
 Enter the extension's call number (e.g., 23)	wait for the internal dial tone
	called party answers
 Speak with your party	connected with called party

* *ISTEC office* = internal dial tone
ISTEC easy/home = external dial tone

6.4 External Calls

6.4.1 External calls with the *ISTEC office*

You can outgoing calls, when your extension has been assigned a class of service *Long distance barred*, *International barred* or *Unrestricted* (see section 7.3.13). If your extension has been assigned *Outgoing barred* or *In and Outgoing barred*, you will hear a busy signal after dialling the „0“.

Action	Result
 Pick up receiver	internal dial tone
 Enter a „0“	external dial tone
 Enter the call number of the external party	wait for external dial tone
	called party answers
 Speak with your party	connected with the external party



Note: You can make two simultaneous external calls.

6.4.2 Direct trunk access / External calls with the *ISTEC easy/home*

The feature *direct trunk access* considerably simplifies placing an external call. You have an external dial tone as soon as you pick up the receiver. The „0“ is dialled automatically. *Direct trunk access* is particularly suited for use with a fax or modem.

You can only use the *direct trunk access* feature on the extensions for which you have programmed it (see section 7.3.13).

On the *ISTEC easy/home*, the feature *direct trunk access* is set permanently.

Action	Result
 Pick up receiver	external dial tone
 Enter the call number of the external party	wait for external dial tone
	called party answers
 Speak with your party	



Note: If, with the *direct trunk access* active, you wish to make an internal call or use other features (e.g., pick-up, internal conference, etc.), this is only possible with a tone dial (DTMF) telephone.

If you have set the extension's class of service to *Outgoing barred* or *In and Outgoing barred*, you will hear a busy tone when you pick up the receiver.

6.5 Speed Dialling (ISTEC office only)

The *speed dialling* feature provides you with up to 60 speed dialling numbers and thus considerably eases the dialling of longer call numbers.

You can first use *speed dialling*, after you have entered the call numbers of the speed dialling destinations in the number memory (**301** to **360**) (see section 7.3.8).

Action	Result
 Pick up the receiver	internal dial tone
 Enter speed dial code (301 to 360)	ringing tone
	called party answers
 Speak with your party	





Note: If you only enter a portion of the call number (e.g., the main number of a company), you can directly dial the desired extension afterwards.

Example: The company's main call number
(as speed dialling destination in the number memory): 09876543

The extension's call number (suffix dialling): 234

6.6 PICK-UP

You want to take an internal or external call, that is currently ringing on another telephone.

Action	Result
 You hear another telephone ringing	
 Pick up the receiver	dial tone *
 Press the flash button, only with ISTEC easy/home	
 Enter the code number „4“	pick up the call from the ringing telephone
 Speak with your party	





Note: You have an extension set to the service identifier **Answering** (Machine), then you can pick up a call where the answering machine has already begun to take a message.

An internally transferred call cannot be retrieved with the *Pick-Up* feature (see section 6.3).

* *ISTEC office* = internal dial tone
ISTEC easy/home = external dial tone

6.7 Collective Call

With the *collective call*, all the free extensions will ring, on which the service identifier has been set to **Telephone**. Only one collective call can be executed at a time.







Action	Result
 Pick up receiver	dial tone *
 Press the flash button, only with ISTEC easy/home	
 Enter the code number „29“	wait for internal dial tone
 Speak with your party	an internal party answers

Note: The *collective call* can also be initiated from an existing external call by pressing the flash button.
If no internal party picks up the call within 45 seconds after a collective call is started, a recall will ring at the extension, where the collective call was initiated.

* *ISTEC office* = internal dial tone
ISTEC easy/home = External dial tone

6.8 Consultation Hold

With the consultation hold, you can interrupt an existing external call, to get information from another internal party. The external call will be automatically held for 1 minute by your ISTEC system.





Action	Result
 Speak with your external party	
 Press the flash button *	
 Enter the extension of the internal party	wait for internal dial tone
 Speak with your internal party	internal party answers
 Press the flash button *	the internal connection is ended
 Enter the code number „0“	connect with the external party

Note: If no internal connection is made, press the buttons „R“ and „0“ again. Then you can continue with your external call.

* only with tone (DTMF) dialling together with the flash button

6.9 Forwarding an External Call - with announcement

You want to forward an existing external call to another internal party, but want to inform the internal party before transferring the call.





Action	Result
 Speak with your external party	
 Press the flash button *	external call is placed on hold
 Enter the extension of the internal party	wait for the internal dial tone
	the called internal party answers
 Speak with your internal party	
 Hang up the receiver	the external call is transferred

Note: If no internal connection is made, press the buttons „R“ and „0“ again. Then you can continue with your external call.

* only with tone (DTMF) dialling together with the flash button

6.10 Forwarding an External Call - without announcement

You can also forward an existing external call without announcement. To do this, hang up your phone after you dial the extension and hear the internal ringing tone.

Action	Result
 Speak with your external party	
 Press the flash button *	the external call is placed on hold
 Enter the extension of the internal party	wait for the internal dial tone
 Hang up the receiver	the external call is transferred



Note: If the internal party does not answer within 45 seconds, the external will ring again on your extension. If you do not take the external call again within 20 seconds, all of the extensions will ring. The external call will ring all available extensions for 45 seconds, and then, if the call has not been taken, the ISTECS system will automatically disconnect the call.

* only with tone (DTMF) dialling together with the flash button





6.11 Retrieving an Internally Forwarded Call

You have forwarded an external call without announcing it. You can retrieve this call, if the party to whom you transferred the call has not yet taken it. There are two possible ways to retrieve the call:

6.11.1 Option 1: You have not yet hung up

Action	Result
 Press the flash button *	
 Enter the code number „0“	connection with the external party
 Speak with your external party	

6.11.2 Option 2 (ISTEC office - only): You have already hung up

Action	Result
 Pick up the receiver	internal dial tone
 Hang up the receiver	
 Rings again	internal ringing tone
 Pick up receiver	connection with the external party
 Speak with your external party	







Note: With option 2, you can also retrieve a collective call.

- only with tone (DTMF) dialling together with the flash button

6.12 Three-party Conference (ISTEC office - only)

6.12.1 Setup a three-party conference



You can extend any external call into a three-party conference by adding an internal party.

Action	Result
 Speak with your external party	
 Press the flash button *	the external call is place on hold
 Enter the extension of the internal party	wait for the internal dial tone
	called internal party answers
 Speak with your internal party	
 Press the flash button *	
 Press the # button	acknowledged tone
 Speak with both (external and internal) parties	

Note: A three-party conference can only be established from a telephone, which has a # button. To setup a three-party conference, you must first establish the external connection (call). You cannot change a broker call (see section 6.13) to a three-party conference call. During a three-party conference call, the features call waiting, door signalling and alarm call are not possible.

* only with tone (DTMF) dialling together with the flash button

6.12.2 Disconnect a three-party conference

Action	Result
 Three-party conference in process	
 Press flash button *	
 Press # button	internal party is disconnect from the three-party conference

Note: If you hang up during a three-party conference, the external party will automatically remain connected with the internal party. Thus, you can also use a three-party conference to transfer a call.











* only with tone (DTMF) dialling together with the flash button

6.13 Broker

During an external call, you can place a second external call and then toggle back and forth between the two calls (broker).

In the ISDN mode **MULTIPLE DEVICE ACCESS**, the broker function is performed as the ISDN broker function by the ISDN central exchange. Therefore, the broker function only uses a single B-channel. The second B-channel remains available for an additional external call.

In the ISDN mode **PBX ACCESS**, the ISTEK telephone system performs the broker function. In this case, both B-channels are required and none are available to make or take another external call.

Action	Result
 You (Party „A“) have a connection with external Party „B“	
 Press the flash button *	the external Party „B“ is placed on hold
 Enter the code number „0“	External dial tone
 Enter the call number of the external Party „C“	external dial tone
	the called external Party „C“ answers
 Speak with the external Party „C“	
 Press the flash button *	the external Party „C“ is placed on hold
 Enter the code number „0“	connected with the external Party „B“
 Speak with the external Party „B“	
 Press the flash button *	external Party „B“ is placed on hold
 Enter the code number „0“	connected with the external Party „C“
...this can be repeated as often as desired...!	
 Hang up the receiver	the external calls are ended

Note: If the second external call is not successful, hang up the phone. An automatic recall will then occur.

If you, as internal party, hang up while in the broker function, both calls to the external parties will be disconnected.

If you wish continue speaking with the other external party, as your current partner to hang up. After your party has hung up, you will be automatically connected with the second external party.

* only with tone (DTMF) dialling together with the flash button

6.14 Call Waiting

6.14.1 Preface

With *call waiting* you will be signalled during a call that another caller is on the other line.

Call waiting is only supported for the service identifiers **Telephone** and **Combi-device**.

The *call waiting* function is not supported while using the door intercom, when brokering, during a collective call or in the course of a consultation hold.





Note: The call waiting signal can interfere with a fax or data connection and can cause the transmission to be aborted. Therefore, the extension on which you operate a fax or modem should have the call waiting function switched off or you should select the service identifier Facsimile or Data Modem for this extension.

Note: How to switch the *call waiting* function ON and OFF is described in section 7.3.6.









6.14.2 Special case - consultation hold:

If you place an external call on a *consultation hold*, after 45 seconds you will hear the *call waiting* signal for the external call. This *call waiting* signal is intended to remind you that you have an external call on hold. If you do not switch back to the party on hold, the call on-hold will be disconnected after about 1 minute.

6.14.3 End your current call and take the waiting call:

Action	Result
 Speak with your party	call waiting is signalled
 Hang up the receiver	current call is disconnected
 Recall rings	phone rings
 Pick up the receiver	connected with the waiting party
 Speak with your party	

6.14.4 Broker (internal and external calls):

Action	Result
 You (Party „A“) are speaking with Party „B“	connected with Party „B“
 Call waiting signal	call waiting signalled
 Press flash button *	Party „B“ is put on hold
 Enter the code number „x“ **	connected with waiting call from Party „C“
 Speak with Party „C“	
 Press flash button *	connect to Party „B“ and put Party „C“ on hold
 Enter the code number „0“	connect to Party „B“
...this can be repeated as often as desired...!	
 Hang up the receiver	disconnect both calls









* only with tone (DTMF) dialling together with the flash button

** x = 0: Switch to external or internal call

x = 7: Switch to door intercom (ISTEC office - only)

6.15 Internal Conference

You can bring additional internal parties into your existing internal call. A maximum of four internal parties can speak with each other in this manner.



Action	Result
 You (Party „A“) are making an internal call	speaking with Party „B“
 Press the flash button *	
 Enter the extension of another internal Party „C“	internal ringing tone internal Party „C“ answers
 Speak with both internal parties „B“ and „C“	call with both internal parties „B“ and „C“
 Press the flash button *	
 Enter the extension of another internal Party „D“	internal ringing tone internal Party „D“ answers
 Speak with all three internal parties „B“, „C“ and „D“	conference call with all three internal parties „B“, „C“ and „D“ one party in the internal conference hangs up
 Continue speaking with the remaining parties in the internal conference	Internal conference with the other parties continues

Note: If the extension, that you have dialled, is busy, you will hear an acknowledge tone. Afterwards, you can continue with the existing call.
If the dialled extension is free, but the call is not answered, press the flash button *, and enter the digit „0“. The ISTEK system will then automatically return to the existing call.

* only with tone (DTMF) dialling together with the flash button

6.16 Auto Call (SW 2.0 and higher)

In the case of a Auto call, as soon as the receiver is picked up a previously entered call number will be dialled. The entry of the call number is described in section 7.3.13.

Action	Result
 Pick up the receiver	dial the previously entered call number
	ringing tone
	called party answers
 Speak with your party	



Note: An Auto call is executed regardless of the extension's class of service.

6.17 Call Restrictor (SW 2.0 and higher)

Using the call restrictor, specific call numbers or portions of them (e.g., the prefix for a charged service call 0190...) are blocked for a single extension. This can help reduce your telephone charges.

If a party attempts to enter a call number which is restricted for this extension, he will hear a busy signal after dialling the number. A call will not be placed to this number.





You can first use the call restrictor after you have entered the call numbers which should be restricted in memory. The entry of the call numbers is described in section 7.3.13.

Action	Result
 Pick up the receiver	internal dial tone
 Dial the restricted call number	busy signal
 Hang up the receiver	

6.18 The Door Intercom (*ISTEC office - only*)



You can only use this feature, when you have properly attached a door intercom to your *ISTEC office*.
You can connect to the door intercom and open the door from every telephone extension.

6.18.1 You hear the door bell and wish to dial the door intercom

Action	Result
 Door bell signals	your telephone rings
 Pick up the receiver	internal dial tone
 Enter the code number „7“	connect with the door intercom
 Speak with your party	
 Hang up the receiver	disconnect







6.18.2 You wish to open the door (while connected with the intercom)

You are already speaking via the door intercom with the person at the door.

Action	Result
 Press the flash button *	
 Enter the code number „7“	door opener is active for about 3 seconds
...this can be repeated as often as needed...!	
 Hang up the receiver	disconnect

* only with tone (DTMF) dialling together with the flash button

6.18.3 During an external call, you wish to dial the door intercom

Action	Result
 Press the flash button *	internal dial tone
 Enter the code number „7“	the external call is placed on hold
 Speak with your party	connected via the door intercom
 Press the flash button *	
 Enter the code number „7“	door opener is active for about 3 seconds
 Hang up the receiver	returned to the external call

Note: Enable the call waiting feature for the extension on which the door intercom should signal so that you will also be signalled during a call.

* only with tone (DTMF) dialling together with the flash button

6.19 Alarm Call (ISTEC office - only, SW 2.0 and higher)

This feature can only be used if you have installed an alarm button instead of a door intercom on your *ISTEC office* and have configured the alarm call (see sections 7.3.12 and 7.3.13).

Pressing the alarm button triggers the alarm call. After the alarm call has been triggered, the assigned telephone will ring for one minute with the alarm signal.

Note: After picking up the receiver you will hear the alarm tone for about 10 seconds and then a busy signal.





During a call, the *ISTEC office* feeds the alarm tone into the conversation. You must first disconnect the current call before you can dial a new number.

Unless you enter a different extension, the alarm call will be placed to extension 21.

6.20 Executing a RESET from a Telephone

If your ISTEC system malfunctions, in the majority of cases this can be cleared by resetting the ISTEC system. When reset, your ISTEC system retains all its settings.

Caution: Resetting the ISTEC system disconnects all existing calls and deletes the record of the charges incurred in the last hour.

Action	Result
 Pick up the receiver	internal dial tone
 Enter the code numbers „8“, „0“	acknowledge tone
 Enter the code numbers „1“, „0“, „0“, „8“	acknowledge tone
 Hang up the receiver	

7 Configuration from a Telephone

7.1 Preface

In this chapter we will show you how to configure your ISTEK system via a telephone on one of the extensions. You can configure the system from any extension. You will need the **PIN** of **extension 21**.

To enable you to verify the correct entry of the code numbers, you should use a telephone with a display for the configuration.

**Caution: Do NOT configure all of the extensions for the *Auto Call* !
If you do, it is not possible to reconfigure the system without a PC.**

7.2 Begin the Configuration

To configure your ISTEK system via a telephone, pick up the receiver and enter the configuration code “8”, “1”, “PIN”. You will then be at the configuration level.

Action	Result
1. Pick up the receiver	internal dial tone
2. Enter the code number “8”, “1”	wait for acknowledge tone
3. Enter the PIN for extension 21	acknowledge tone

After entering the code numbers “8” and “1”, you must wait for the acknowledge tone. This will sound for about 3 seconds after the digit “1” is entered. This pause serves to hinder accidental reconfiguration.

After each entry of a code number you will generally hear an acknowledge tone. You must wait for this acknowledge tone, before entering the next code number.

If you make a syntax error in your entry, you will hear a busy signal. In this case, you must hang up the receiver and begin the configuration again.

After entering all the code numbers for a feature, you will hear two short acknowledgement signals. You can now either:

- hang up the receiver to quit the configuration, or
- continue directly to the configuration of other features.

7.3 Features

7.3.1 Setting the ISDN mode

You can set the ISDN mode (MULTIPLE DEVICE ACCESS or PBX ACCESS) from any telephone on the system. Which mode you must select depends on the ISDN mode of your ISDN line.

7.3.2 Multiple Subscriber Number

7.3.2.1 Entering the Multiple Subscriber Numbers (MSNs)

To enable direct dialling in to your extensions, you must assign at least one MSN to each extension. For this purpose each MSN is entered in a MSN memory location (01 to 10).

7.3.2.2 Assigning a ringing sequence to a MSN

You can assign each MSN a specific ringing sequence. You can then hear, based on the sequence, which MSN your caller dialled. In this manner, you could, as an example, determine whether it is a business or private call.

7.3.2.3 MSN Assignment

After entering a MSN in a MSN memory location (see section 7.3.13) you must assign this MSN to one or more extensions. This procedure is called MSN Assignment. To assign a MSN to an extension, you enter the last digit of the extension's call number in the MSN memory location.

7.3.3 Entering the central number

If your ISTECH system is operated in the ISDN mode PBX ACCESS, you must enter the central number that you were assigned.

7.3.4 Music-on-Hold

If the *Music-on-Hold* feature is active, an external caller will hear music while his call is on hold.

7.3.5 Day / night configuration (*ISTEC office* - only)

You can store two different configurations in the *ISTEC office*. You can use one of these configurations to transfer all the calls that come late in the evening or on the weekend to specific number or to answering machine. The *day / night configuration* feature enables you to toggle back and forth between the two configurations.

7.3.6 Call waiting

You can switch *call waiting* on and off for each extension individually. The call waiting feature will only take effect on extensions with the service identifier **telephone** or **combi-port**. For each extension, call waiting is always switched ON/OFF for:

- all of the calls to the extension's assigned MSNs and
- all internal calls to the extension.

7.3.7 Multi-Function-Memory (*ISTEC office - only*)

The Multi-Function-Memory has space for 60 call numbers (call number 301 to 360).

In the Multi-Function-Memory you can:

- enter the call numbers for speed dialling,
- assign a different ringing sequence,
- enter the number to be called with the Auto Call, and
- enter the numbers to be restricted.

The memory location for each call number is structured in the following manner:

- 20 digits for the call number (maximum)
- the attribute “call number for extension(s) x”
with the default value “for all extensions”
- the attribute “Auto Call for extension x”
with the default value “no Auto Call”
- the attribute “call number restricted”
with the default value “not restricted”
- the attribute “special signalling for all extensions”
with the default value “standard signalling”

Note: The digit “0” the trunk access must also be entered in the number memory.

7.3.8 Speed dialling (*ISTEC office - only*)

A speed dialling code can, depending on the attribute “call number for extension(s) x”, be dialled from every extension listed in the attribute. The speed dialling codes are the numbers **301 to 360**. A speed dialling code takes priority over the class of service, in other words, when an extension is not permitted to place outgoing calls. A speed dialling code also takes priority over the call restrictions.

If a speed dialling code is not valid for the extension, you will hear a busy signal.

7.3.9 *Call restrictor (ISTEC office - only)*

With the *call restrictor* feature you can block access to certain numbers or block all numbers with, as an example, a specific prefix (e.g., 0190...) for a specific extension. This may help you lower your telephone costs.

Before you can use the *call restrictor* feature, you must enter the call number, that should be blocked, in the number memory (see section 7.3.13).

A restricted call number can, depending on the attribute “call number for extension(s) x”, be restricted for each extension individually.

Only those numbers will be checked that are entered from the telephone keypad.

If a restricted call number is detected, the dialling will be interrupted and the extension will be given a busy signal.

If the restricted call number is also available with a speed dialling code and this speed dialling code is available for the extension, the restriction can be circumvented by dialling the speed dialling code.

Note: By entering the digit “9” as the internal call number, you restrict the selected call number in the number memory for all the extensions.

7.3.10 Auto Call (*ISTEC office - only*)

When the *Auto Call* feature is active, a previously entered call number will be immediate dialled after the receiver is picked up.

You can enable/disable the *Auto Call* for each individual extension by assigning the extension in the attribute for the call number in the number memory.

Note: An *Auto Call* will be performed regardless of the extension's class of service.

Caution: Do NOT enable *Auto Call* for all extensions! If you do, you will not be able to reconfigure the *ISTEC* system without a PC.

7.3.11 Assigning a ringing sequence to the calling number (*ISTEC office - only*)

You can assign a specific ringing sequence to a call number in the number memory. You can then hear who is calling by listening to the sequence. In this manner, you could, for example, hear whether the call is business or private.

The special signalling for this call number will be used for *all* extensions, which are assigned to the MSN dialled by the caller.

This special signalling **only** functions for callers whose equipment pass on the **caller ID** (call number). If the call number is not sent, the standard signalling will be used, since the system can't determine who is calling.

If "no signalling" is chosen as the value for the call number's special signalling attribute, an incoming call with this caller ID will be rejected with the appropriate message informing the caller that their call was rejected. You should note that the other extensions assigned to this MSN group can also not be called by this caller.

7.3.12 Changing the PIN of extension 21 (Config-PIN)

You can change the **PIN** for extension **21 (Config-PIN)** from a telephone on any extension. To change the **PIN**, you must know the current **PIN** of extension **21**.

7.3.13 Alarm call (*ISTEC office* - only)

The alarm call is triggered by pressing the alarm button. This feature is only available when instead of a door intercom a switch is connected to the *ISTEC* system. Once an alarm call is triggered, the assigned telephone will ring for one minute with the alarm signal.

Note: If the assigned telephone is making a call the *ISTEC office* will feed the alarm signal into the call.

Unless you assign the alarm call to another extension, it will be signalled on extension 21 (factory setting).

Table 7.3.13
Call number plan for the telephone configuration

Reset the ISTE C		8	0		Reset-PIN	●
ISDN mode: Multiple Device Access / PBX Access		8	1	◆	Config-PIN	●
Initialise the ISTE C to the factory settings		8	1	◆	Config-PIN	●
Central number	Enter	8	1	◆	Config-PIN	●
	Delete	8	1	◆	Config-PIN	●
MSN	Enter	8	1	◆	Config-PIN	●
	Delete	8	1	◆	Config-PIN	●
MSN Assignment ON / OFF		8	1	◆	Config-PIN	●
Direct trunk access ON / OFF		8	1	◆	Config-PIN	●
Call waiting for extension ON / OFF		8	1	◆	Config-PIN	●
Charge metering ON / OFF		8	1	◆	Config-PIN	●
Alarm function ON / OFF		8	1	◆	Config-PIN	●
Enter a new Config-PIN		8	1	◆	Config-PIN	●
Signalling, evaluated by CdPN (Called Party Number)		8	1	◆	Config-PIN	●
Music on hold ON / OFF		8	1	◆	Config-PIN	●
Day / Night configuration		8	1	◆	Config-PIN	●
Country code		8	1	◆	Config-PIN	●

Service Identifier:

Combi-port	8	1	◆	Config-PIN	●
Telephone	8	1	◆	Config-PIN	●
Fax (Group 3)	8	1	◆	Config-PIN	●
Modem	8	1	◆	Config-PIN	●
Datex Modem (Datex-J ¹)	8	1	◆	Config-PIN	●
Answering machine	8	1	◆	Config-PIN	●

Class of service:

In and outgoing barred	8	1	◆	Config-PIN	●
Outgoing barred	8	1	◆	Config-PIN	●
Long distance barred	8	1	◆	Config-PIN	●
International barred	8	1	◆	Config-PIN	●
Unrestricted	8	1	◆	Config-PIN	●

Call forwarding:

Call forwarding setup	8	5	◆	PIN	●
Call forwarding cleared	8	5	◆	PIN	●

¹ Datex-J is the German videotext system.

0	● 0	● 1/2	■			
1	● 0	● 0	● 8	●		
1	● 1	● Central number	▲			
1	● 1	●				
1	● 2	● No. of MSN (01-10)	● MSN	▲		
1	● 2	● No. of MSN (01-10)	●			
The extension's call number (21-28)		● 7	● 1 / 0	● No. of MSN (01-10)		
The extension's call number (21-28)		● 6	● 1 / 0	■		
The extension's call number (21-28)		● 2	● 1 / 0	■		
The extension's call number (21-28)		● 2	● 3/4	■		
The extension's call number (21-28)		● 2	● 7/8	■		
4	● new Config-PIN	● new Config-PIN	■			
5	● No. of MSN (01-10) (Multiple Device Access)	● Type of signalling	■			
	● Extension (1-8) (PBX Access)					
8	● 1 / 0	■				
9	● 0 / 1	■				
6	● 0	● LK	● LK	● LK		■

The extension's call number (21-28)	● 4	● 1	■	
The extension's call number (21-28)	● 4	● 2	■	
The extension's call number (21-28)	● 4	● 3	■	
The extension's call number (21-28)	● 4	● 4	■	
The extension's call number (21-28)	● 4	● 5	■	
The extension's call number (21-28)	● 4	● 6	■	

The extension's call number (21-28)	● 1	● 0	■	
The extension's call number (21-28)	● 1	● 1	■	
The extension's call number (21-28)	● 1	● 2	■	
The extension's call number (21-28)	● 1	● 3	■	
The extension's call number (21-28)	● 1	● 4	■	

Type	● Destination Number						

Multi-Function-Memory:

Programming the Multi-Function-Memory location 3xx (Default setting for new entries or overwriting a location: speed dialling code for <i>all</i> extensions, <i>no</i> special signalling, <i>no</i> Auto Call)	8	1	◆	Config-PIN	●
Activate/Deactivate the memory location 3xx as speed dialling code for extension x	8	1	◆	Config-PIN	●
Restrict/release the call number in memory location 3xx for extension x	8	1	◆	Config-PIN	●
Activate the Auto Call for extension x (Number to be called: call number in memory location 3xx)	8	1	◆	Config-PIN	●
Deactivate the Auto Call for extension x	8	1	◆	Config-PIN	●
Special signalling, evaluates the CgPN (Calling Party Number) (Compare the CgPN with the call number in memory location 3xx)	8	1	◆	Config-PIN	●
Clear a MFM memory location (number + attributes)	8	1	◆	Config-Pin	●

The memory location (301-360)	● 1	● call number			
The memory location (301-360)	● 2	● Station (1-9)	● 1 / 0		
The memory location (301-360)	● 3	● Station (1-9)	● 1 / 0	■	
The memory location (301-360)	● 4	● Station (1-8)	■		
300	● Station (1-8)	■			
The memory location (301-360)	● 5	● Type of signalling	■		
The memory location (301-360)	●				

Description of the symbols used:

- ◆ 3 sec. pause, then a longer confirmation signal
- shorter confirmation signal
- ▲ signal after each of the entered digits
- double tone
- ☎ hang up the receiver
- wait, until the LED lights again

Abbreviations:

Reset-PIN:	the code '1008'
Config-PIN:	PIN of extension 21
Speed dialling codes:	The Multi-Function-Memory locations, that are setup for speed dialling (permitted are the memory locations '301' to '360')
LK:	country code

Table 7.3.14: The types of call forwarding:

Call forwarding	Class	Description
Type 1 immediate	1	Call forwarding immediately when called
Type 2 when busy	2	Call forwarding only when busy
Type 3: after n rings	3	Call forwarding after 3 x rings at the called extension
	4	Call forwarding after 4 x rings at the called extension
	5	Call forwarding after 5 x rings at the called extension
	6	Call forwarding after 6 x rings at the called extension
	7	Call forwarding after 7 x rings at the called extension
	8	Call forwarding after 8 x rings at the called extension
	9	Call forwarding after 9 x rings at the called extension
	0	Call forwarding after 10 x rings at the called extension

Table 7.3.15: Type of signalling, evaluated by CdPN /
Special signalling, evaluated by CgPN

Type	Description
0	No ringing, call will be rejected
1	Standard (default)
2	Sequence 1
3	Sequence 2
4	Sequence 3

Destination call number:

The call number of the party who will receive the forwarded call.

This can be:

- a two-digit number (internal call forwarding)
- a three-digit speed dialling code or
- a three or more digit external call number.

The trunk access code '0' must prefix the call number when forwarding a call to an external party !

Note: If a speed dialling code (e.g., 306) is given as the destination and the entered call number is then read with the PC, the PC will display the actual call number assigned to this speed dialling code.

Station (1-8):

the number of an extension without the leading '2',
e.g., '4' for extension 24

Station (1-9):

like Station (1-8), plus 9 = *all* extensions

No. of the MSN:

as in the configuration programs "MSN Assignment" window,
now 01...10, not the call number

CdPN:

Called Party Number, passes the MSN called

CgPN:

Calling Party Number, passes the call number of the caller

8 If something doesn't function

8.1 Malfunctions

This summary should help you locate and correct most problems that might occur. We recommend, that you first try resetting the ISTECS system with the telephone (see section 7.3.13). In cases where the ISTECS system's programmed state is uncertain, it often helpful to initialise the system to the factory settings (see section 8.2).

Malfunction	Possible cause	Remedy
no internal dial tone	<ul style="list-style-type: none"> ● Telephone is not connected ● Power outage ● Power supply is not plugged in ● Telephone defective ● Telephone system malfunction 	<ul style="list-style-type: none"> ● Connect telephone ● Check the mains ● Plug the power supply into the mains ● Repair telephone ● Reset ISTECS system via a telephone (see section 6.20) or inform service
no internal calls	<ul style="list-style-type: none"> ● Telephone is not connected ● Telephone defective ● Telephone system malfunction ● Programmed with call forwarding (special dial tone) ● Programmed with ringing sequence „OFF“ 	<ul style="list-style-type: none"> ● Connect telephone ● Repair telephone ● Reset ISTECS system via a telephone (see section 6.20) or inform service ● Deactivate call forwarding ● Program a different ringing sequence

No trunk access

- Set for the wrong ISDN mode (MULTIPLE DEVICE ACCESS / PBX ACCESS)

- Select the correct ISDN mode (appropriate for your ISDN access)

Malfunction	Possible cause	Remedy
	<ul style="list-style-type: none"> ● ISDN line not connected ● ISDN cable defective ● Access not enabled ● Class of service incorrectly programmed 	<ul style="list-style-type: none"> ● Connect ISDN line ● Replace ISDN cable ● Contact network operator ● Correct the programming of the class of service
busy signal after accessing the trunk	<ul style="list-style-type: none"> ● All B-channels are in use 	<ul style="list-style-type: none"> ● Wait and try again later
No incoming calls	<ul style="list-style-type: none"> ● ISDN line not connected ● Class of service incorrectly programmed ● Set for the wrong ISDN protocol (DSS1/1TR6) ● Set for the wrong ISDN mode (MULTIPLE DEVICE ACCESS / PBX ACCESS) ● Wrong MSN entered ● No central number entered ● ISDN line is defective ● ISDN cable defective 	<ul style="list-style-type: none"> ● Connect ISDN line ● Correct the programming of the class of service ● Select the ISDN protocol appropriate for your ISDN access (see section 3.2) ● Select the correct ISDN mode (appropriate for your ISDN access) ● Enter the correct MSN or initialise the ISTE C system to the factory settings ● Enter the appropriate central number ● Contact the network operator ● Replace ISDN cable
Voice connections are distorted	<ul style="list-style-type: none"> ● Defective ISDN Bus installation 	<ul style="list-style-type: none"> ● Correct the connection of the wire pairs or call service

No data transfer possible between PC and ISTE C

- PC cable not properly plugged in
- Serial interface or interrupt not properly set up

- Plug the PC cable in
- Locate and select an available serial port and/or

Malfunction	Possible cause	Remedy
	<ul style="list-style-type: none"> ● Transfer rate of the PC's serial port is not set to 9600 bit/s ● PC cable is defective ● The serial interface on either the PC or the ISTECS system is defective 	<p>an available interrupt</p> <ul style="list-style-type: none"> ● Set the transfer rate to 9600 bit/s ● Replace the PC cable ● Check the interface on the PC and on the ISTECS system

8.2 Initialising the ISTEK System to the Factory Settings

If your ISTEK system malfunctions, you can generally clear the malfunction by resetting the telecommunication system via a telephone on one of the extensions (see section 7.3.13).

If the system still malfunctions after the reset, you should initialise your ISTEK system to the factory settings.

Caution: By initialising the system to the factory settings, all of the configuration settings you have made will be lost and recorded charges will be cleared.

To initialise the system to the factory settings, proceed as follows:

Action	Result
Pick up the receiver	internal dial tone
Enter the code „8“, „1“	wait for the acknowledge tone
Enter the PIN of extension 21 (four digits)	wait for the acknowledge tone
Enter the digits „1“, „0“, „0“, „8“	wait for the acknowledge tone after each digit
Hang up the receiver	
Wait about 2 minutes	the ISTEK system will be initialised to the original factory settings

8.3 Important Service Numbers

Hotline: Telephone: 0190 / 79 33 01
Fax: 01805 / 25 86 19
Monday to Friday from 8:00 to 17:00

Mailbox: - analogue access:
Call number: 069 / 95 40 90 14

Additional information regarding the operation of an analogue modem with the Emmerich Mailbox can be found on the next page.

- ISDN Access
Call number: 069 / 95 40 90 13
Protocol: X75

8.4 Modem Settings for the Emmerich Mailbox

Shown below are the settings for accessing the Emmerich Mailbox with an analogue modem.

Serial parameters:	Transfer rate:	9600 bit/s to 28800 bit/s
	Data bits:	8
	Parity:	no
	Stop bits:	1
	Handshake:	RTS/CTS
File transfer protocol:	Z-Modem	
	Y-Modem	
	X-Modem	

9 Technical Appendix

9.1 Call Number Plan

Below is a summary of the call numbers used within your **ISTEC** telecommunication system (they can be dialled from any extension).

Code Number	Description
0	Trunk access code (ISTEC office - only)
Flash button and 0	Consultation hold, call waiting, broker
21 to 23 (ISTEC easy) 21 to 26 (ISTEC home) 21 to 28 (ISTEC office)	Call number of the extensions
29	Collective call
301 to 360	Speed dialling code (ISTEC office - only)
4	Pick-Up, Pick-up from answering machine
7	Door intercom
Flash button and 7	Door opener
81(PIN)	Switch to configuration level (PIN = four digit code)
85(PIN)1z	Call forwarding immediately, internal and external (PIN = four digit code, z = call number)
85(PIN)2z	Call forwarding when busy, (ISTEC office - only), internal only (PIN = four digit code, z = call number)
85(PIN)wz	Call forwarding after n rings, (ISTEC office - only), internal only (PIN = four digit code, w = number of rings: 3 to 10, z = call number)

9.2 Audible Tones and Ringing Signals (Summary)

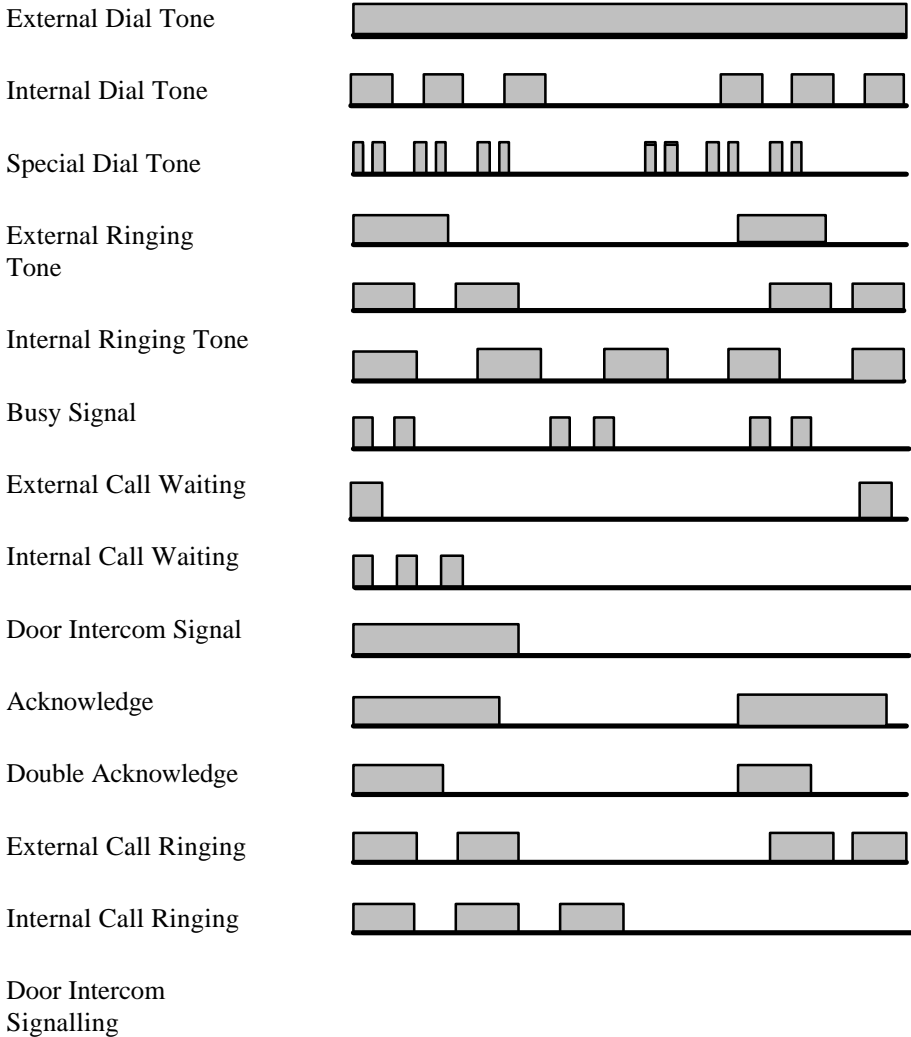

9.3 Connections / Terminal Strip (ISTEC 1008)

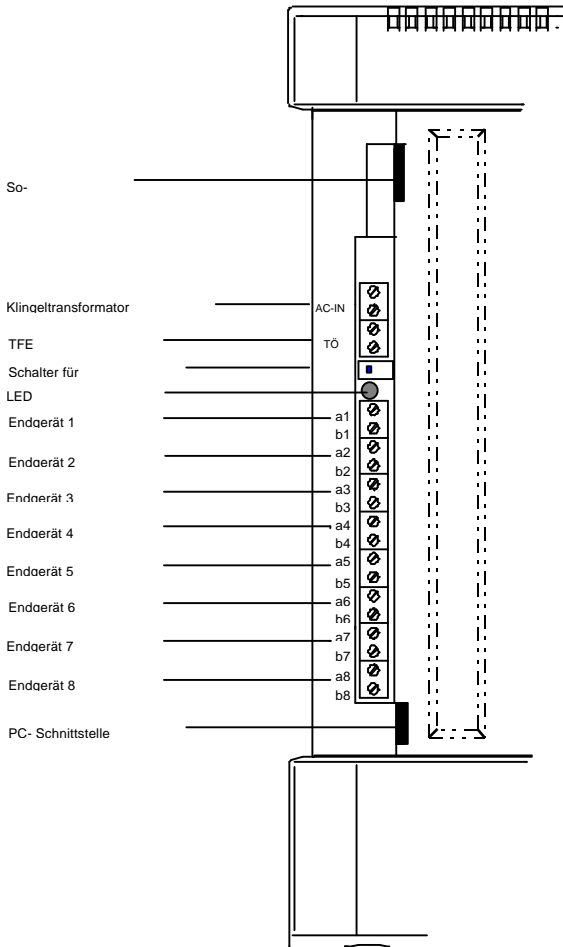

9.4 Technical Specifications

9.4.1 Analogue Lines

Current:	approx. 20 mA constant current
Voltage:	approx. 24 V
Impedance:	max. 2 x 75 Ohm
max. cable length:	max. 650 m with 0.4 mm diameter wires max. 1000 m with 0.6 mm diameter wires
Ringing voltage:	approx. 48 V~/50 Hz
Dialling modes:	pulse (ISTEC 1003/1008 - only) tone (DTMF) with R-button as Flash button
Transmission:	12TR4-3 and Part 7 to 1TR810
Frequency of the audible tone:	approx. 440 Hz
Connectors:	screw terminal strip

9.4.2 Digital ISDN Line

Interface:	S0
ISDN protocol:	DSS1 (Euro-ISDN) 1TR6 (ISTEC 1003/1008 - only)
ISDN mode:	PBX Access (P-P) Multiple Device Access (P-MP)
Number of MSNs:	max. 10
S0 Connector:	Jack RJ-45 (Western jack)

9.4.3 Power Supply

Type:	Plug-in mains unit
Mains voltage:	230 V~ ± 10 % / 50 Hz
Current:	max. 18 VA

9.4.4 PC Connection

PC interface:	galvanic isolated RS 232c
Transfer rate:	9,6 kbit/s

PC connector: 6 pin RJ-45 jack (Western jack)

9.4.5 Mechanical

Case: plastic case
Dimensions (HxWxD): 252 mm x 156 mm x 42 mm
Weight: approx. 1200 g
Operating temperature: 0 °C ... 40 °C
Storage temperature: -20 °C ... 60 °C

9.4.6 German Certification Number BZT: A 113 637 E

10 Glossary

Analogue terminal ... can be e.g., telephones, fax machines, modems etc., that use (-->) analogue transmission.

Analogue transmission Voice (or data) is transmitted from one (-->) subscriber to another over the telephone lines in the form of variations (normally sinusoidal) in the voltage.

AOCD Advice of Charge **D**uring the Call. (-->) Call charge data

AOCE Advice of Charge at the **E**nd. (-->) Call charge data

B-Channel The data and speech are transferred over the B-Channels. A (-->) A BRI has 2 B-Channels. Each (-->) external call requires 1 B-Channel.

Basic Rate Interface An ISDN access from the public ISDN operator (telecom). It corresponds to 2 telephone lines. Also called Basic Rate Access

BRI See **Basic Rate Interface**

Call charge data In ISDN there are two ways in which to inform the (-->) subscriber of the charges for the call. In the first method all charges are passed at the end of the call. This version is called **AOCE** (Advice of Charge at the **E**nd of the Call). In the second version the charges are passed both during and at the end of the call. This version is called **AOCD** (Advice of Charge **D**uring the Call).

Channel Communications pipe between the (-->) ISDN telecommunications system and the (-->) ISDN exchange.

Class of service The class of service is used select which classes of calls may be made from an extension. If the extension has been assigned the class of service "unrestricted", any call number may be called. If an extension has been assigned the class of service "In and outgoing calls barred", it can only be used to make internal calls between extensions.

Configuration Individually setting the functions and features of the telecommunication system to satisfy your requirements using a telephone or a special PC program.

D-Channel Signalling channel. The D-Channel is used to transfer the ISDN control and use information such as dialled digits, (-->) service identifier and (-->) call charge data.

DDI **d**irect **d**ialling in. (-->) Direct dialling number to an (-->) extension.

Digital transmission Speech is converted to digital data. This data is sent over the telephone lines from (-->) subscriber to another (-->) subscriber. At the other end the data is converted back in to speech (analogue signal).

Direct dialling number The direct dialling number is the portion of the call number that is evaluated by the (-->) telecommunications system. On a Multiple Device Access, the direct dialling number is a MSN that has only been assigned to one extension. On a PBX Access, the direct dialling number is generally the internal call number of the (-->) extension.

Door intercom An intercom terminal that is mounted at the door or gate, which after the bell button has been depressed will establish a connection to a (-->) telecommunication system. A voice connection to the door intercom can then be made using a telephone on an extension.

DTMF Telephone equipment using the **D**ual-**T**one **M**ulti-**F**requency system convert the dialled digits into tones and pass these on the (-->) exchange. The exchange translates the tones to the corresponding digits. Therefore, DTMF is also called tone dialling.

EAZ Endgeräte-Auswahl-Ziffer. Direct dialling number in the German (-->) ISDN protocol 1TR6. Not used outside of Germany.

Exchange The exchange is the location, where the telephone connection is established between the caller and the called. All (-->) external calls are made via an exchange of the local telephone company. In the USA, an exchange is also referred to as the central office.

External call A call placed to a (-->) subscriber, whose (-->) terminal is not connected on your (-->) telecommunication system. The call is thus made via the telephone company's exchange.

Extension This term is used for both the station (port) on a (-->) telecommunication system and for the device that is connected to this port.

Internal Call This is a call between two (-->) parties, whose (-->) terminals are connected on the same (-->) telecommunication system. Internal calls are free of charge since they do not go over the telephone company's line.

ISDN **I**ntegrated **S**ervices **D**igital **N**etwork. ISDN is a system that combines in a single telecommunication network under the same call number a variety of different services (telephone, video phone, data transmission, Telex etc.).

ISDN mode The ISDN operation mode for a Basic Rate Interface. In Germany, a (---) BRI can be operated in the ISDN mode (---) PBX ACCESS or the ISDN mode (---) MULTIPLE DEVICE ACCESS.

ISDN protocol A specification, that defines the exchange of information and the sequential procedures (handshaking) between an ISDN terminal and an (---) ISDN exchange.

The Deutsche Telekom AG currently supports both of the following protocols:

1TR6: German ISDN Protocol

DSS1: European ISDN Protocol

ISDN Exchange An (---) exchange that can handle the switching to create an ISDN connection between the caller and the called subscriber.

Message-on-Hold An external party hears music or a message while his call is on hold. This music or message is input from an analogue audio source that is connected to the ISTEK telecommunication system.

Modem Modem is the acronym for **Modulator/Demodulator**. A modem is a device that enables the transfer of data between computers in the form of analogue signals.

MSN Multiple Subscriber Number. The MSN is assigned by the telephone company as an ISDN call number when using the (---) ISDN protocol - DSS1 and the ISDN mode (---) MULTIPLE DEVICE ACCESS. In Germany, three MSNs are included in the basic monthly charge and more MSNs can be had for a small monthly fee. It is possible to have an MSN per extension and thus support (---) direct dialling in on a MULTIPLE DEVICE ACCESS BRI.

Multiple Device Access An (---) ISDN operation mode for the (---) BRI, in which up to 8 ISDN terminals can be connected to a single (---) NTBA. One or more of these ISDN terminals can also be small ISDN telecommunications systems.

Music-on-Hold An external party hears music while his call is on hold.

NTBA Network Termination Basic Access, the telephone company's ISDN network terminator. The ISTEK telecommunication system is connected through the NTBA with the (---) exchange.

Operator station The operator station is the central that answers all incoming calls. From the operator station, the caller will then be transferred to the desired party. Normally the operator station is assigned the (---) extension "0". The operator station is a feature that is only available in the ISDN mode (---) PBX ACCESS.

Party A person who is using a (---) terminal (usually a telephone) in a call.

PBX Telecommunications system (previously referred to as private branch exchange)

PBX Access An (---) ISDN operation mode for a (---) BRI, in which only one ISDN device can be connected to the NTBA and this is normally a (---) telecommunication system.

PIN Personal-Identification-Number. The PIN is a code number that is used to limit the programming of the ISTEK telecommunication system to authorised personnel.

Pull-down menu A menu, that after it clicked opens a list of submenus. Typical pull-down menus are those of MS-Windows 3.x. Pull-down menus are sometimes called drop-down menus.

Pulse dialling In pulse dialling, the dialled digits are converted into a string of current pulses and then passed to the (---) exchange. The exchange then interprets these pulses. Pulse dialling is primarily used with the older electromechanical exchanges.

R-Button Signal button. This button is used to, for example, place a call on hold while making a consultation call or initiate another function.

Flash button: The R-button is generally implemented as a Flash button on tone (DTMF) dialling equipment. Pressing the R-button interrupts a current loop.

Earth button: On pulse dialling equipment the R-button is generally implemented as an earth button. In this case, a third wire is required. For this reason, most (---) telecommunication systems do not support the earth button.

Service Identifier **With calls from ISDN terminals or ISDN telecommunication systems, the ISDN network transfers also transfers a so-called service identifier.** This additional information identifies the form of service that the answering device should handle for example service identifier "Telephone" for a telephone call or "Facsimile" to accept a fax.

The idea of the service identifier is to prevent the connection of incompatible (---) terminals (e.g., Fax and Telephone). An ISDN connection is only made when the service identifier of the calling terminal is compatible with the service identifier of the called (---) extension or terminal equipment.

Unfortunately, many systems have their fax connected to extensions which are configured with the service identifier "Telephone". The result is that these fax machines will not be able to send a fax to a fax machine that has been properly configured with a service identifier "Facsimile". In the last years the equipment makers have begun including support for the so-called combi-port which answers both "Telephone" and "Facsimile" service identifiers.

S₀-Bus The interface between the (---) NTBA and the terminal equipment on a (---) BRI. It is a four-wire bus that supports a total (---) transfer rate of 144 kbit/s (---) 2 B-Channels each with 64 kbit/s and a (---) D-Channel with 16 kbit/s.

Subscriber A party who has a call number on the public telephone or ISDN network.

Terminal Can be either an analogue or a digital device, that is used for telecommunications, such as a telephone, fax machine, answering machine, (---) modem, etc.

Trunk access Connection between a (---) party and the telephone company's (---) exchange.

Transfer rate The transfer rate specifies the amount of data that is transferred between two terminals (e.g., two modems) within a specific period of time. The transfer rate is generally given in bit/s (---) bits per second) or kbit/s (kilo-bits per second, kilo = 1024).

Transfer rate The transfer rate specifies the amount of data that is transferred between two terminals (e.g., two modems) within a specific period of time. The transfer rate is generally given in bit/s (---) bits per second) or kbit/s (kilo-bits per second, kilo = 1024).