

# Merit LILIN CMX Software HD 3.6 User Manual

## Table of Contents

Chapter 1. Using CMX Software HD 3.6.....	7
Chapter 1-1. System Settings .....	7
Chapter 1-2. Add a New Device .....	8
Chapter 1-3. Device Type .....	10
Chapter 1-4. ONVIF Setting.....	10
Chapter 1-5. IPScan Utility.....	11
Chapter 1-6. Alarm Output Management.....	11
Chapter 1-7. Enable Alarm Input .....	12
Chapter 2. Recording Settings .....	13
Chapter 2-1. Schedule Recording Settings .....	13
Chapter 2-2. Motion Detection Recording .....	13
Chapter 2-3. Recording at System Startup.....	15
Chapter 2-4. Estimated Recording Days .....	15
Chapter 2-5. Network Storage.....	15
Chapter 3. Grouping Settings .....	17
Chapter 3-1. Grouping Name .....	17
Chapter 3-2. Grouping's Devices .....	18
Chapter 3-3. Grouping Authentication.....	18
Chapter 3-4. Recall a Grouping .....	18
Chapter 3-5. Grouping Sequence.....	19
Chapter 3-6. Main Grouping .....	19
Chapter 3.7. Window-divisions.....	19
Chapter 3.8. Dynamic Video Channel Editing .....	20
Chapter 3.9. Digital Zoom .....	20
Chapter 3.10. Two-way Audio.....	21
Chapter 4. CMX Software HD 3.6 Video Playback.....	22
Chapter 4-1. Playback.....	22
Chapter 4-2. Playback for a IP Camera within the Main Grouping.....	22
Chapter 4-3. Remote DVR Playback .....	23
Chapter 4-4. Remote DVR File Download .....	24
Chapter 4-5. AVI File Exporting & Play From a File .....	24
Chapter 4-6. Snapshot .....	25
Chapter 4-7. Alarm Event Playback.....	25
Chapter 5. User Settings .....	26
Chapter 5-1. Add a User .....	26
Chapter 5-2. Modify an Existing User .....	26
Chapter 5-3. Delete a User .....	27
Chapter 5-4. User Authorization.....	27
Chapter 5-5. Alarm Email Notifications .....	27
Chapter 6. PTZ Control Panel .....	28
Chapter 6-1. Preset Point Settings .....	28
Chapter 6-2. CMX Software HD 3.6 Status Panel.....	29
Chapter 6-3. Control PTZ via PIH-931D Keyboard .....	29
Chapter 6-3-1. DVR Control Mode.....	29
Chapter 6-3-2. Window-division .....	30
Chapter 6-3-3. Recall a Camera .....	30
Chapter 6-4. IP Camera ePTZ or ROI Feature.....	31
Chapter 6-5. Keyboard Playback.....	31

<b>Chapter 7. eMap Manager .....</b>	<b>32</b>
<b>Chapter 7-1. Before Accessing eMap Manager .....</b>	<b>32</b>
<b>Chapter 7-2. Tool Bar .....</b>	<b>33</b>
<b>Chapter 7-3. eMap Alarm Options.....</b>	<b>34</b>
<b>Chapter 7-3-1. Setup a Map .....</b>	<b>34</b>
<b>Chapter 7-4. Setup a Device on a Map.....</b>	<b>35</b>
<b>Chapter 7-4-1. Delete a Device on a Map .....</b>	<b>35</b>
<b>Chapter 7-4-2. Arrange a Device .....</b>	<b>36</b>
<b>Chapter 7-4-3. Device Property .....</b>	<b>36</b>
<b>Chapter 7-5. Find a Device on eMap.....</b>	<b>36</b>
<b>Chapter 7-6. Camera View Control .....</b>	<b>37</b>
<b>Chapter 8. Web Server .....</b>	<b>38</b>
<b>Chapter 9. Database Manager.....</b>	<b>39</b>
<b>Chapter 9-1. User Operational Report .....</b>	<b>39</b>
<b>Chapter 9-2. Event Report.....</b>	<b>39</b>
<b>Chapter 9-3. Database Maintenance.....</b>	<b>40</b>
<b>Chapter 9-4. Import Database .....</b>	<b>40</b>
<b>Chapter 9-5. Export Database .....</b>	<b>40</b>
<b>Chapter 10. Retail and Distribution Business Solutions.....</b>	<b>41</b>
<b>Chapter 10-1. POS Connection Basis for Retail Business .....</b>	<b>41</b>
<b>Chapter 10-2. Test POS Communication with a PC.....</b>	<b>42</b>
<b>Chapter 10-3. Link POS with a Channel .....</b>	<b>42</b>
<b>Chapter 10-4. Playback with POS Transactions.....</b>	<b>43</b>
<b>Chapter 10-5. Search POS Transactions.....</b>	<b>44</b>
<b>Chapter 10-6. Scanner Connection Basis for Transportation Business .....</b>	<b>44</b>
<b>Chapter 11. Mobile Phone Support.....</b>	<b>46</b>
<b>Chapter 11-1. iPhone and iPad support.....</b>	<b>46</b>
<b>Chapter 11-2. Android Support.....</b>	<b>47</b>
<b>Chapter 12. Trouble Shooting.....</b>	<b>49</b>
<b>Chapter 12-1. What should I do if I experience video flickering in CMX .....</b>	<b>49</b>
<b>System Requirement.....</b>	<b>50</b>
<b>Username and password .....</b>	<b>50</b>
<b>Benchmark Environment: .....</b>	<b>50</b>
<b>H.264 benchmark table .....</b>	<b>51</b>
<b>CMX 3.6 HD Software Specification .....</b>	<b>52</b>

## **CMX Software HD 3.6 User Manual**

Central Management Software (CMX Software HD 3.6) is a total solution for managing LILIN's network products including IP cameras and DVRs. CMX Software HD 3.6 contains (1) network video recording software, (2) eMap Manager, (3) Database Manager, (4) Web Server, and (5) Remote DVR playback and file download.

Major features including unlimited H.264/JPEG IP cameras and DVR's cameras recording, remote DVR video playback and file download, and camera groupings with user authentication are integrated within one system application.

One important feature of eMap is the central management system for live monitoring, alarm snapshot management, and map management. IP devices installed at different locations can be represented and managed by using maps.

Circular recording, schedule recording, individual HDD recording configurable, and individual camera recording configurable provide the flexibilities in managing recording storages. CMX Software HD 3.6 is designated for hybrid solution for IP camera, video server, IP Fast Dome, and DVRs. It provides total solutions for digital surveillance. Major features are:

### **CMX Software HD 3.6 Main Features**

1. Record and manage unlimited channels of H.264/JPEG HD IP cameras or DVR's cameras.
2. Scheduling, continuous, and motion detection recording supported
3. eMap live video with alarm snapshots
4. Integrated alarm management for alarm output
5. Web server for live video
6. iPhone and Android phones support
7. Retail and transportation business solutions
8. Device grouping and recall
9. IP Fast Dome control
10. Export recorded video to AVI file format
11. Easy-to-use calendar and time selections for video playback
12. User access levels configurable for groupings and features
13. Complete operational event logs
14. Two-way audio and audio recording
15. Digital zoom, device ePTZ and ROI supported
16. Dynamically video channels swapping with mouse drag-and-drop

### **Copyrights**

Merit LILIN Enterprise Co. Ltd. holds exclusive ownership of the software and all intellectual property rights embodied therein, including copyrights and valuable trade secrets incorporated in the software's design and coding methodology. The software is protected by international treaty. This agreement provides you with only a limited use license, and does not grant you any intellectual property rights in the software.

Adobe and Acrobat Reader are either registered trademarks or trademarks of Adobe Systems Incorporated in the United States and/or other countries.

Windows, Windows 2000, Windows XP, Windows Vista, and Windows 7 are registered trademark of Microsoft Corporation in the United States and other countries

### How to Register CMX Software HD 3.6

To register CMX Software HD 3.6, please click on Register button from Login dialog box or About button to register the software. To get unlocking key, please visit <http://www.ddnsipcam.com/cgi-bin/cmXReg.cgi>. Please type all the necessary information. The unlocking will be sent to your email account.



After receiving the unlocking key, please click on Register button. Enter mail address and unlocking key to get full access of CMX Software HD 3.6.

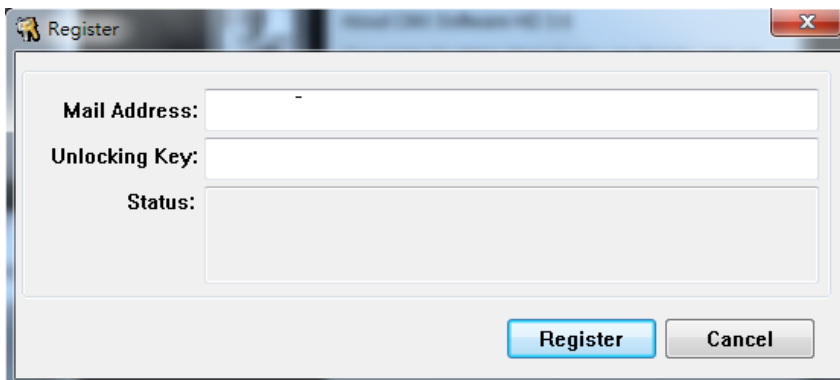

### General Notations

The terms of IP-based devices or products used in this document refer to H.264 HD/JPEG IP Fast Domes, Video Servers, or IP Cameras. The terms of DVR devices/products refer to DVR 3 and 5 series.

## Before Using CMX Software HD 3.6

CMX Software HD 3.6 contains video recording. CMX Software HD 3.6 supports multiple hard disk drives recording. If overwritten setting is enabled, the oldest recorded video clips get deleted first. If you want logical partitions in your hard disk drive, please setup at least 20 GB for each drive. To setup hard disk setting, please click on “System Setting” button.



Select recording hard drives for CMX Software HD 3.6 recording. To enable HDD overwritten option, please check this option.

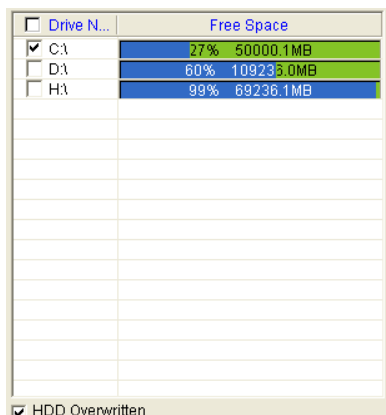

Furthermore, each logical HDD drive should contain at least 10% empty space for storing video data. CMX Software HD 3.6 deletes the oldest files first until it reaches 90% of the logical drive, and it proceeds to the next logical hard disk drive for recording.

## On-line User Manual

CMX Software HD 3.6 adopts Acrobat Reader for its on-line manual by clicking on “Windows-> Merit LILIN CMX HD 3.6->User Manual”. You must install Acrobat Reader before opening the on-line manual.

## Uninstall CMX HD 3.6

To uninstall CMX HD 3.6, please select Start->Program Files->Merit LILIN CMX HD 3.6->Uninstall. A user might want to export the database. Re-import the database after new installation. Please see Database Manager for detail.

## Using CMX Software HD 3.6 on Windows Vista and Windows 7 platforms

When you install CMX Software HD 3.6 on Windows Vista and Windows 7 platforms, please go to control panel->User Account Control Setting and low the setting to Default. This can make sure that CMX can login automatically when watch dog performs system reboot.

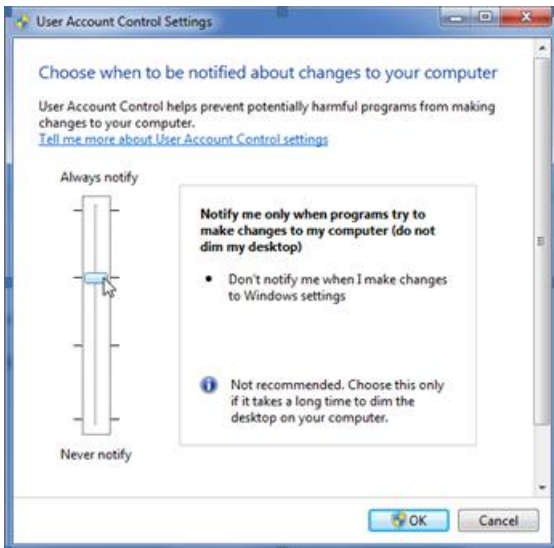

## CPU Usage

To limited CMX Software HD 3.6 CPU usage, a user can click on CPU usage button to limit CPU usage at certain percentage.



## Chapter 1. Using CMX Software HD 3.6

To access CMX Software HD 3.6, follow these steps:

- 1) Click on CMX Software HD 3.6 via Start->Program Files->Merit LILIN CMX Software HD 3.6->CMX Software HD 3.6.
- 2) Click on CMX Software HD 3.6 on desktop.

To login CMX Software HD 3.6, please follow these steps:

- Step 1. Select a user from User name dropdown list.
- Step 2. Type the password or leave it blank if you are first time to use this software.
- Step 3. Click on OK button.

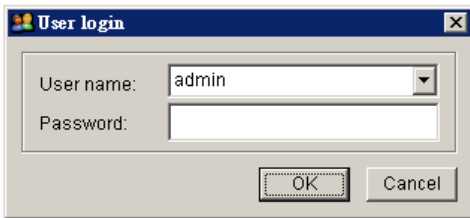

**Note:** The default passwords for all users are empty.

### Chapter 1-1. System Settings

System settings contain HDD settings, device settings, and grouping settings. Please finish System Setting before operating CMX Software HD 3.6.

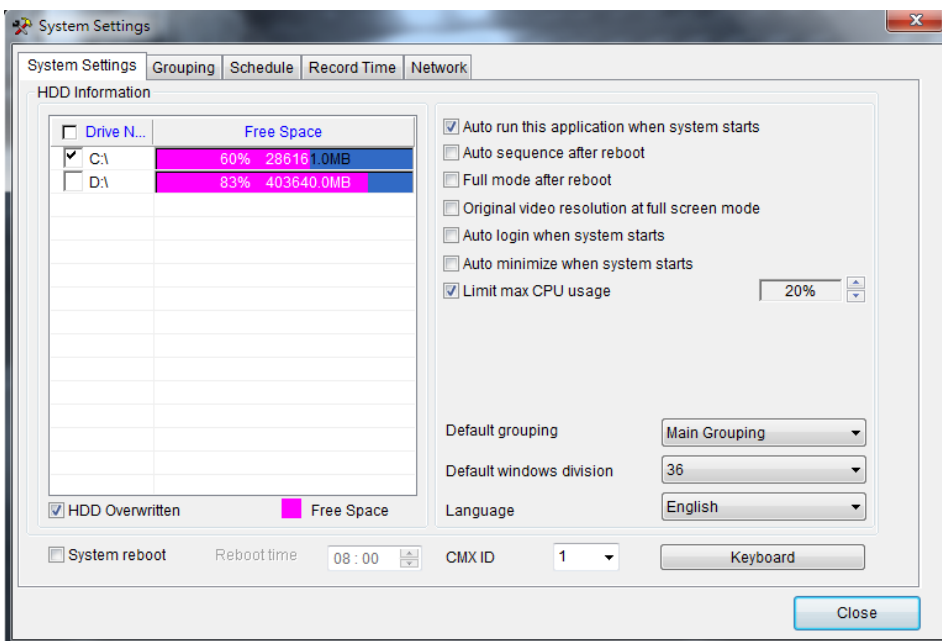

- **Auto run this application when system starts:**  
CMX Software HD 3.6 auto-run when Windows starts
- **Auto sequence after reboot:**  
Perform grouping sequence after system reboot.
- **Full mode after reboot:**  
Perform full screen mode after system reboot.
- **Original video resolution at full screen mode:**  
Use original resolution at single channel view mode. Do not scale original video.
- **Auto login when system starts:**  
Bypass login when system starts.
- **Default grouping:**  
Set default grouping at start-up.
- **Auto minimized when system starts:**  
CMX runs in the background when system starts.
- **Limit max CPU usage:**  
Limit the CPU usage at certain rate.
- **Default grouping:**  
Set default grouping.
- **Default window division:**  
Set default window division at start-up.
- To enable circular recording, please check HDD Overwritten option. To select HDDs for recording, please select HDD(s) for recording in HDD Information list box.
- **System reboot:**  
enable the system to reboot every day at certain time.
- **CMX ID:**  
The CMX ID controlled by PIH-931D keyboard
- **Language:**  
To choose language setting, please select your language from Language combo box.

## Chapter 1-2. Add a New Device



To add a particular device, please first select the channel and click on “Property” button for adding a new device. The “Camera Settings” dialog box shows up. Please type at least, IP/DNS address, port number, username, and password for connecting the live video of the device. You can also click on “Find Device” and selection one device from the IPScan tool. Click on “Detect” button for detecting the device type.



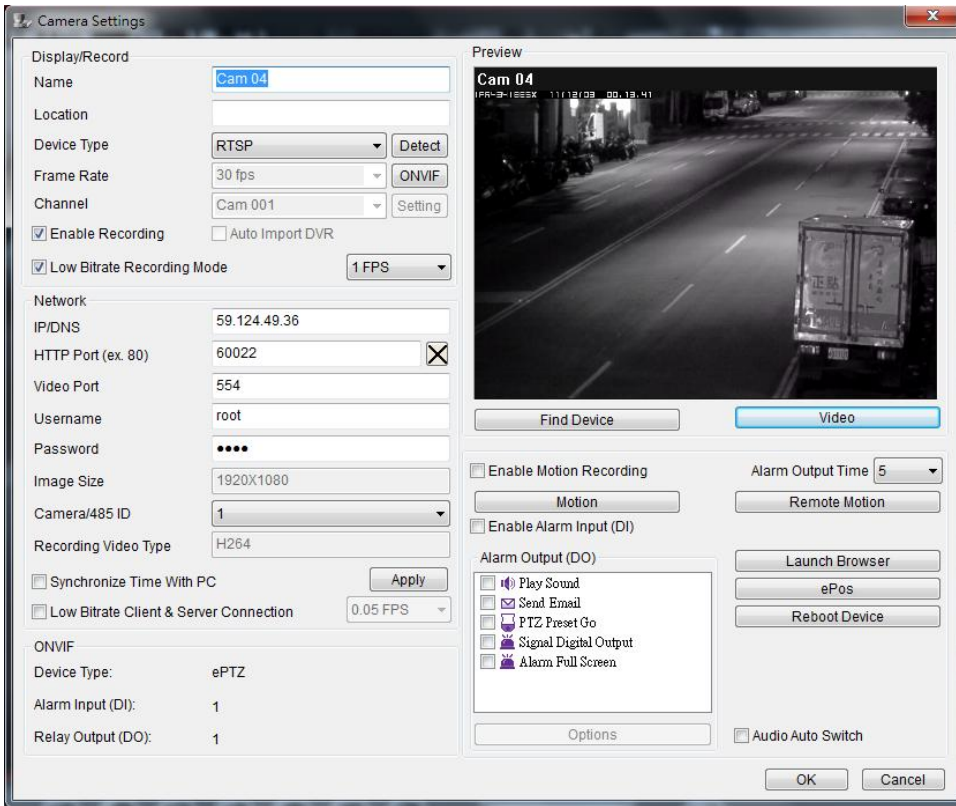

To edit Camera Setting dialog box, please right mouse click on a channel and select Camera Properties menu item.

1. Name— camera name which is displayed on top of live video channel
2. Location—indicating the location of the camera installed.
3. Frame rate—frame rate for the device
4. ONVIF--frame rate and video quality settings based on ONVIF protocol.
5. Device type—device type selection box, RTSP is for H.264 D1 or H.264 HD IP cameras.
6. Enable recording—enable or disable recording for the device
7. Auto Import DVR--auto import DVR cameras into CMX automatically
8. Low Bitrate Recording Mode --record one frame per second.
9. IP/DNS (required)—the IP address of the device
10. HTTP Port number—the HTTP port number of the device
11. Video Port number—DVR's video port number/IP camera's RTSP port number
12. Username—the username which is allowed to login the device
13. Password—the password for the username
14. Image size—the source video size of the device
15. Camera/485 ID—IP Fast Dome RS-485 ID.
16. Low Bitrate Client and Server Connection—Connect in between CMX in low bitrate mode.
17. Synchronize Time with PC—Synchronize time with the remote PC.

**Note:** 1. RS-485 camera ID (1 to 128) must match the ID setting of the IP Fast Dome. The software may not control PTZ movement if the ID setting is incorrect.

If the above settings are done, you can click on Connect button to test if the device is properly  
For default username and password information, please see appendix for detail.

### Chapter 1-3. Device Type

There are few device type drivers for connecting streaming:

- RTSP--Connect an IP camera with RTSP streaming protocol.
- DVR-JPEG--Connect a DVR by MJPEG protocol.
- DVR-H264--Connect a DVR by H.264 protocol.
- CMX-JPEG--Connect a CMX by MJPG protocol.
- Low Bitrate IP Camera--Connect an IP camera by low bitrate protocol.
- Low Bitrate DVR Camera--Connect an IP camera by low bitrate protocol.
- Looping Camera--For demonstration purpose, you can choose Looping Camera at Device Type selection box for duplicate video channel without physically connecting to an IP camera or a DVR's camera. It can reduce bandwidth for the network video.

The screenshot shows a configuration window for a camera channel. The 'Device Type' dropdown menu is open, displaying a list of options: IP Fast Dome, PVS-1020, PIH-036/038, H.264 AVC IP Fast Dome, H.264 AVC IP Mini Dome, H.264 AVC VS012, H.264 IPR IP Cam IP454/8, DVR004, IPD552EX, RTSP (highlighted), DVR-JPEG, DVR-H264, CMX-JPEG, Low Bitrate IP Camera, Low Bitrate DVR Camera, Manual, and Looping Camera. The 'RTSP' option is selected. Other settings visible include 'Name' (Cam 03), 'Location', 'Frame Rate', 'Channel', 'Enable Recording' (checked), 'Low Bitrate Recording Mo' (unchecked), 'Network', 'IP/DNS', 'HTTP Port (ex. 80)', 'Video Port', 'Username', and 'Password'. There are also buttons for 'Detect', 'ONVIF', and 'Setting'.

### Chapter 1-4. ONVIF Setting

To use RTSP streaming, please first setup ONVIF protocol. The detail setting of ONVIF is described as below:

- Profile: a user can select different streaming profile such as H.264 720P or JPEG 720P.
- Protocol: streaming protocol such as RTP/UDP, RTP/TCP, or RTP/TCP/HTTP.
- Quality: compression quality
- Brightness: brightness setting of the video
- Saturation: saturation setting of the video
- Contrast: contrast setting of the video
- Sharpness: sharpness setting of the video
- Frame rate: change frame rate setting of the IP camera.

- Bit Rate: bit rate setting of the video

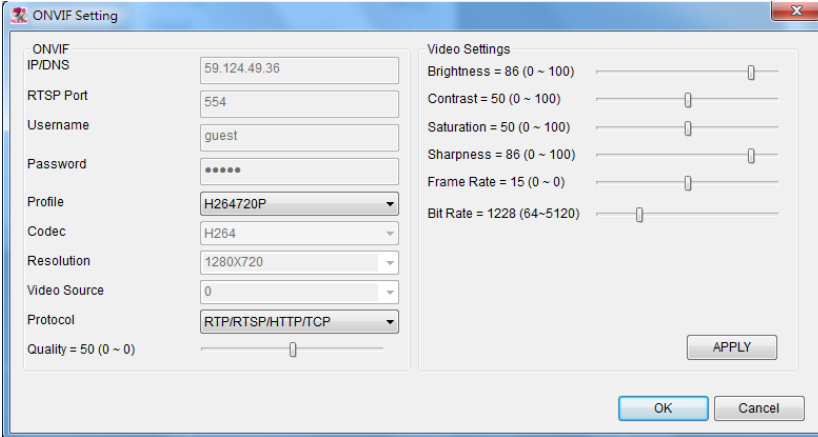

**Note:** ONVIF setting can only be supported by LILIN's ONVIF camera.

### Chapter 1-5. IPScan Utility

To find out the network devices, IPScan utility can scan through all IP address within LAN.

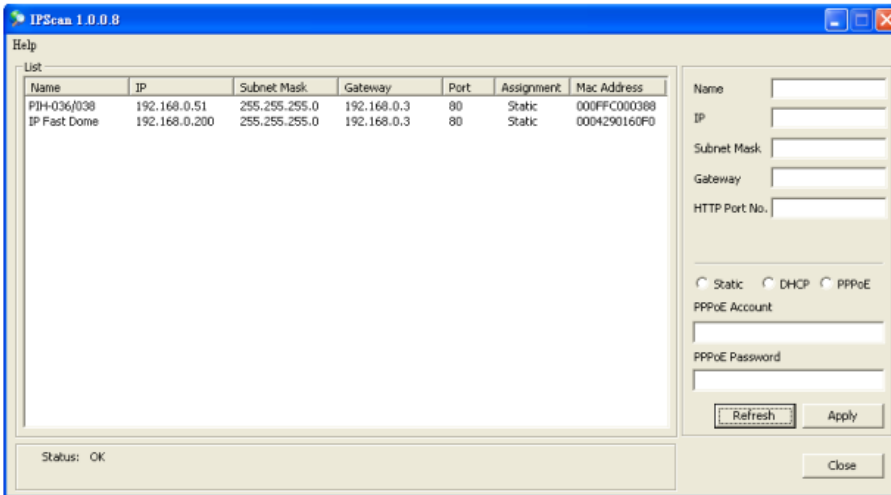

A user can select a device item in IPScan and click on Close button to setup the device. All the device information such as IP address and port number get automatically carried over CMX Software HD 3.6. Click on Connect button in the device dialog box which can test the connection between the PC and the device.

**Note:** IPScan can only work under LAN environment, not Internet environment.

### Chapter 1-6. Alarm Output Management

For motion and remote motion alarm detection management, the alarm output feature allows

various reactions after receiving an alarm. The alarm output includes:

- (1) Play sound--Trigger PC alarm sound after receiving an alarm.
- (2) Send email--Send an JPEG email snapshot after receiving an alarm.
- (3) PTZ Preset Go--Recalling a PTZ preset after receiving an alarm.
- (4) Signal Digital Output--Triggering a DO output of an IP camera after receiving an alarm.
- (5) Alarm Full Screen--Triggering full screen mode after receiving an alarm.

Please select the alarm output from the selection list to enable the option.

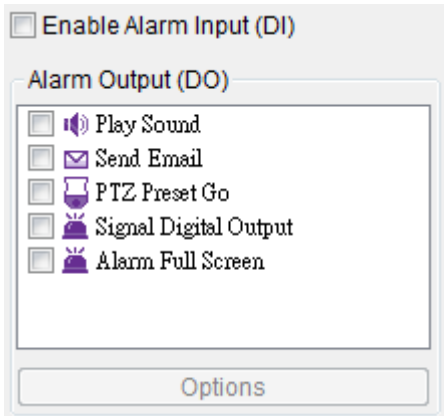

### Chapter 1-7. Enable Alarm Input

CMX Software HD 3.6 can be managed to receive remote IP camera motion detection signal and CMX motion detection signal. Depend on IP camera models, CMX Software HD 3.6 can also receive alarm signals including face detection alarm, tampering detection alarm, audio alarm, and dry-contact digital input alarm. These alarm signals can be received by CMX and eMap manager. Please enable "Enable Alarm Input (DI)" option for receiving alarms.

## Chapter 2. Recording Settings

CMX Software HD 3.6 is configured as continuous recording after an IP camera is connected. To change recording configuration, please follow the following selections.

### Chapter 2-1. Schedule Recording Settings

CMX Software HD 3.6 can schedule recording based on “Always”, “No Record”, and “Motion recording for a particular hour.



To enable recording for a particular hour, please click on the week control and set the recording option for the hour. Please also specify the recording type by selecting one of the recording types.

To enable recording schedule for all hours, please click on Apply button for “Apply All Schedule”.

To apply the recording settings for all cameras, please click on Apply button for “Apply Schedule to All Channels”

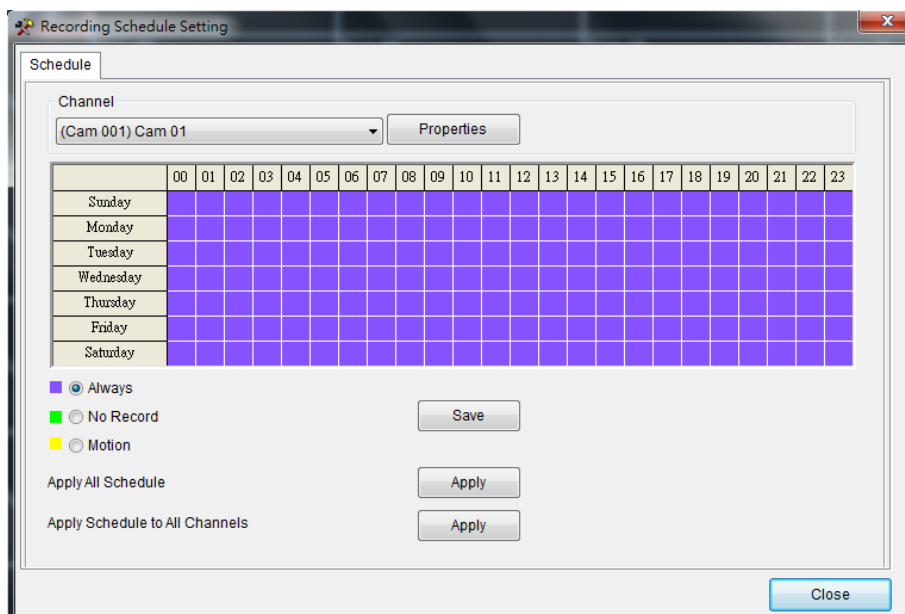

### Chapter 2-2. Motion Detection Recording

To enable motion detection recording, please click on camera “Property” button to enable “Camera Settings” dialog box. Once the IP camera is configured properly, please click on “Video” button to test the video streaming.



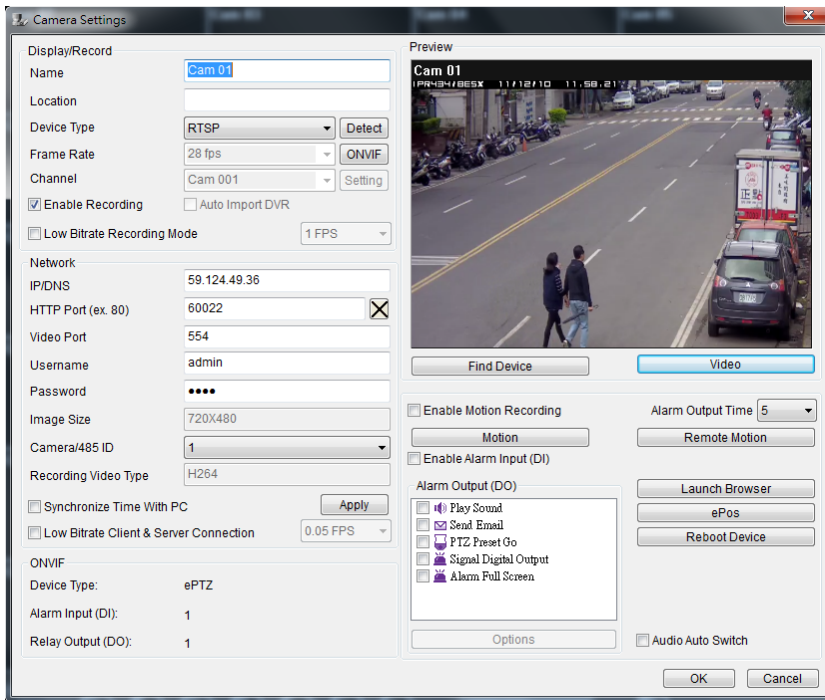

Please click on “Motion” button to setup motion detection. There are up to four motion areas available for a user to configure. Perform mouse-dragging on the video area to define a motion area. Perform right-mouse click can clear a area or clear all areas. To change motion detection sensitivity, please click on the scroll bar for adjust.

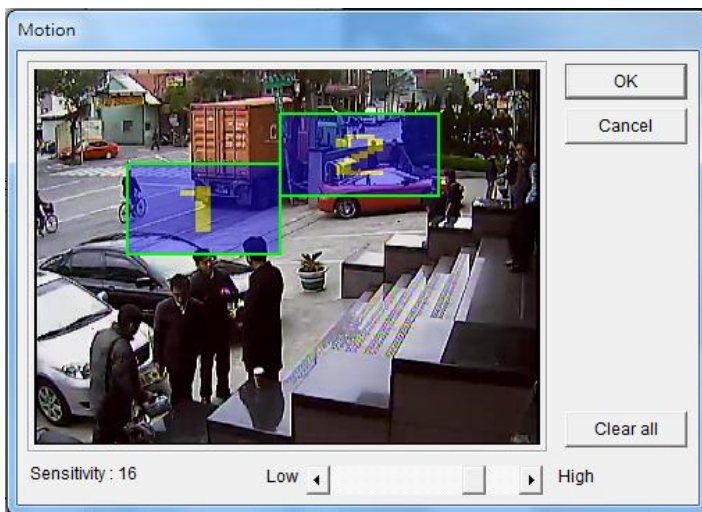

At live monitoring mode, if a motion detection is triggered, the camera window shows “little man” to indicate a motion detection event.



### Chapter 2-3. Recording at System Startup

After the restart of CMX Software HD 3.6, CMX Software HD 3.6 starts recording automatically. There is no need to restart recording service. If a schedule is set, CMX Software HD 3.6 records video based on the schedule at startup.

### Chapter 2-4. Estimated Recording Days

After system installation, to estimate approximate recording days, a user can click on System setting button to enable system dialog box. Click on “Record time” tab. Estimated recording day and time information gets shown on the dialog box.

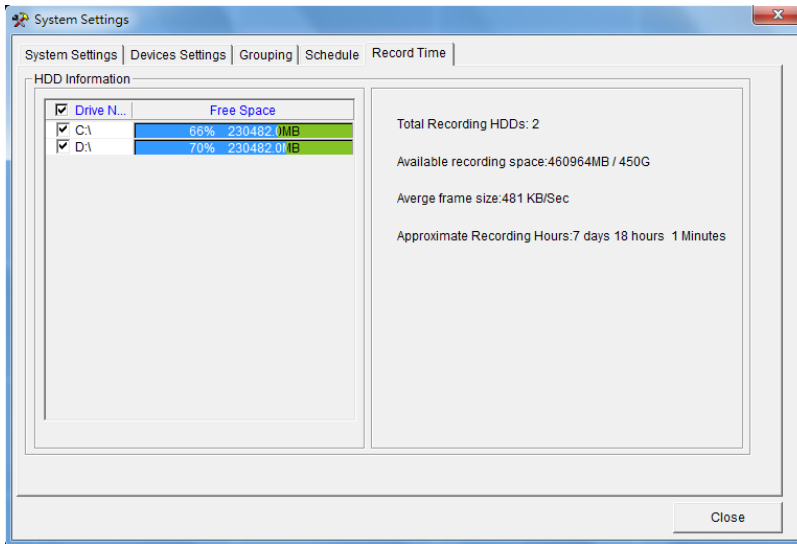

### Chapter 2-5. Network Storage

For recording over network storage such as iSCSI or NAS storage, a user can configure CMX Software HD 3.6 to record the video to the network storage, if the network storage supports “Network Neighborhood” protocol.

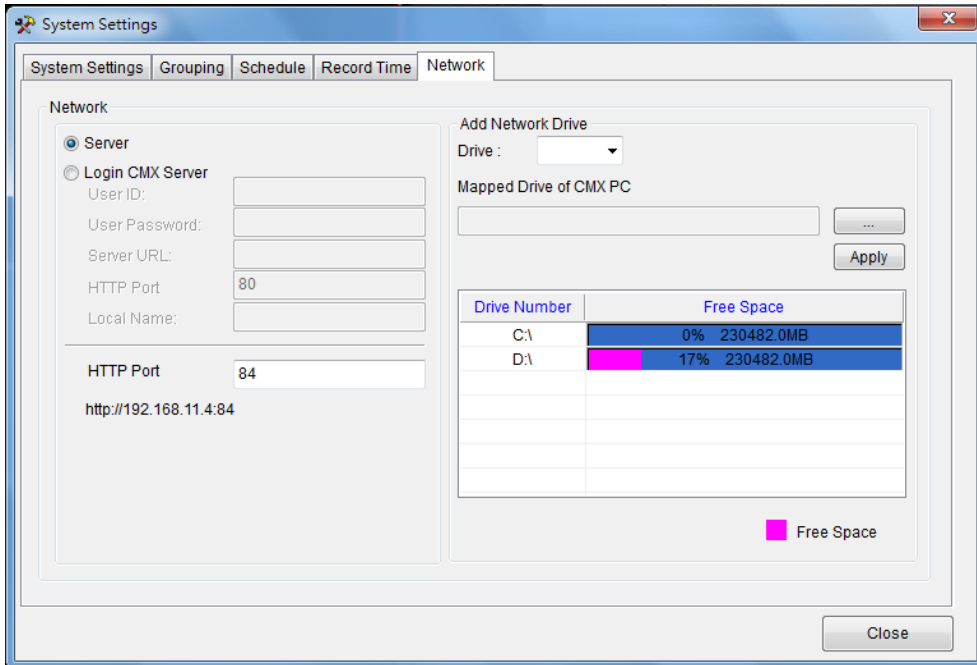

To do so, please first select a drive at “Add Network Drive” list. Select network storage by click on “Mapped Drive of CMX PC” button. Once the network storage is selected, click on Apply button. At the last, please check the newly added network storage from Drive Number for enabling the storage. CMX records based on the selected drivers at circular recording basis.





## Chapter 3. Grouping Settings

A user may want to manage camera or DVR groupings based on their geographic locations or their functions. The video of the grouping devices can be recalled easily later on. To setup groupings, please click on the Grouping button and follow the followings steps.



1. Select left IP Cam/DVR grouping and select right grouping item. Click on Right button to create a grouping.
2. Click on Up or Down button to change the sequence in Grouping tree view.
3. Click on Apply button for the grouping settings.

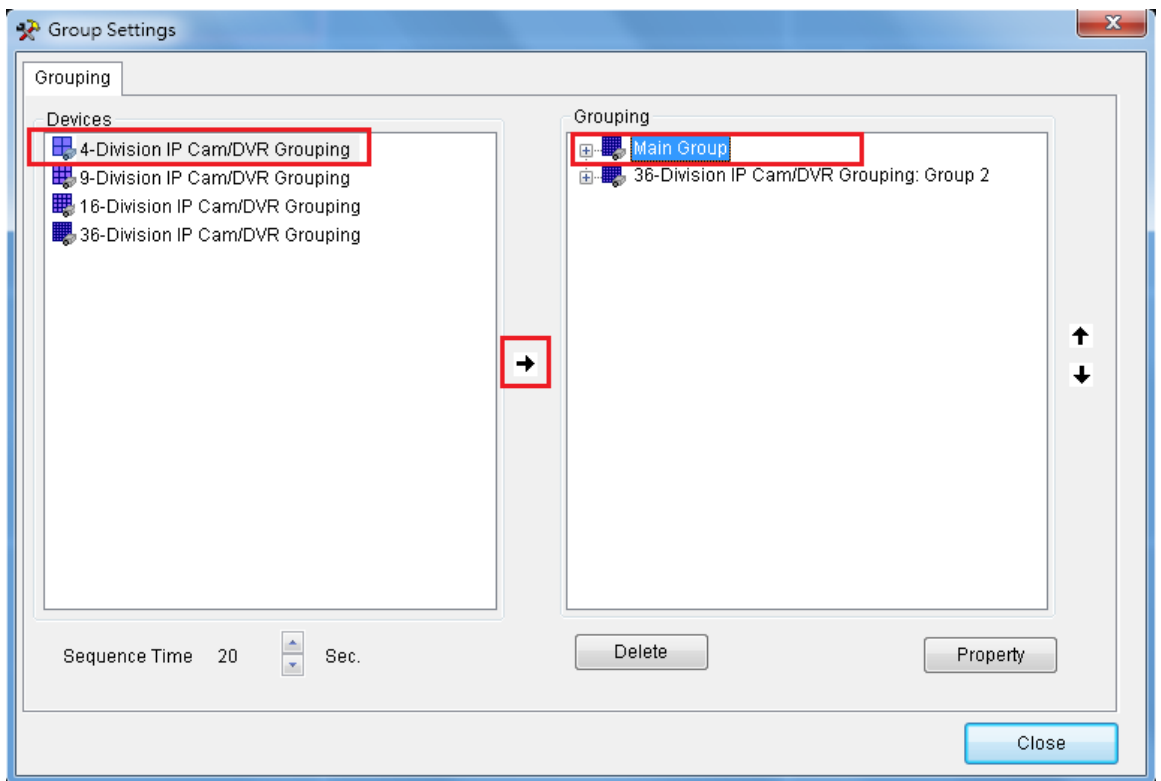

Once the groupings are set, a user can switch to different grouping view quickly.

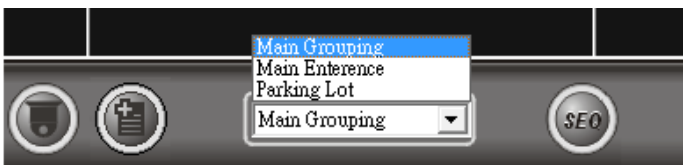

### Chapter 3-1. Grouping Name

A user can assign a name for a grouping. To assign grouping name, please right click on a

grouping, or select on a grouping and click on Property button for its name. Type the grouping name in Grouping dialog box.

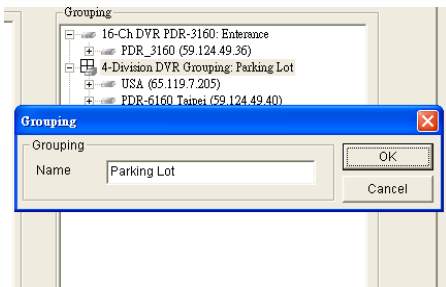

### Chapter 3-2. Grouping's Devices

Once a grouping is set, please select the device of the grouping. Right click on the pre-assigned grouping device item. Select on the device item and perform right mouse click for assigning Property.

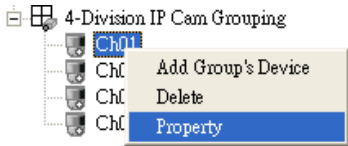

### Chapter 3-3. Grouping Authentication

To assign a grouping access right, please right click on a grouping and select Property menu item. It shows a Grouping Access dialog box. The default setting of a grouping allows every user to access. To disable access right, please uncheck a user access right. Grouping access right also applies to web server. Only groupings assigned to a user can be seen by the user after login to the web server.

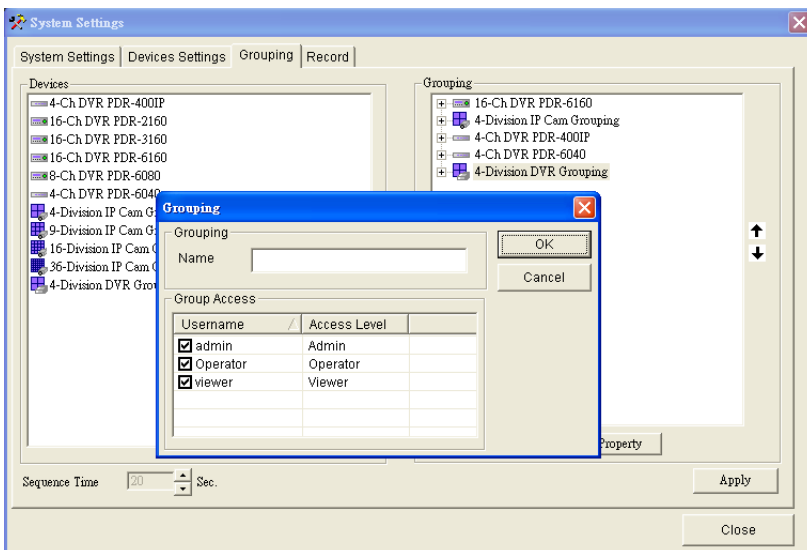

### Chapter 3-4. Recall a Grouping

To recall a grouping, click on grouping drop down list.



### Chapter 3-5. Grouping Sequence

In grouping tab, please specify Sequence Time. In live monitoring mode, please click on SEQ button to perform Sequence Display feature.



### Chapter 3-6. Main Grouping

Main Grouping refers to CMX Software HD 3.6's main screen which contains 36 windows-division screen. To add a device for the main grouping, please follow the steps:

- (1) Select Main Grouping in grouping dropdown list.
- (2) Right mouse click on one of the cameras.
- (3) Select Camera Properties to assign the camera properties.

Alternatively, a user can add devices into Main Grouping at System Settings->Device Settings. Device Settings allows a user to manage up to 36 channels of IP cameras, video servers (PVS-1020 and PIH-1000S), and H.264 HD IP' cameras.

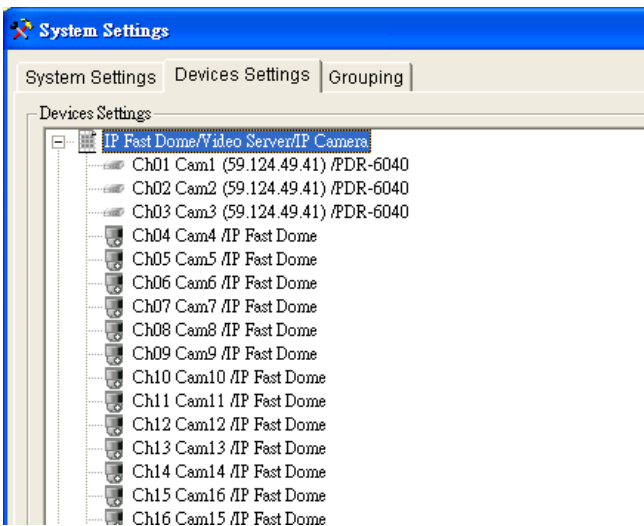

### Chapter 3.7. Window-divisions

Currently, CMX Software HD 3.6 supports four types of window-division including maximized window (each view), 4-window-division, 16-window-division, and 36- window-division. To see the maximized camera window, you can select particular camera window and click on Each View button. You can also double-click on the live video for the maximized window. To see 4-

16-, and 36-window-division, click on the window-division buttons.

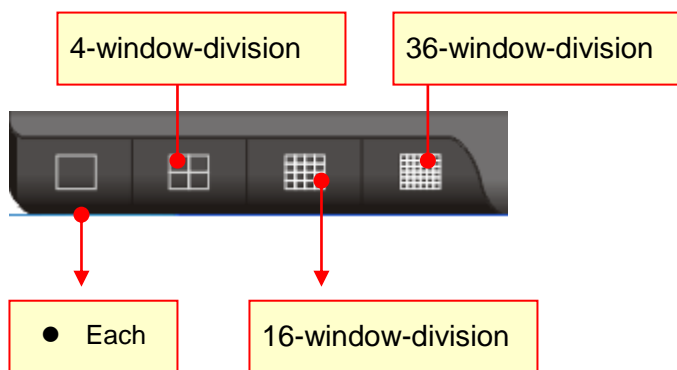

### Chapter 3.8. Dynamic Video Channel Editing

If a user wants to change the arrangement of a camera channel, the user can drag a camera and drop to another video channel. This operation swaps these two cameras' positions dynamically in software. There is no need to re-assign all the IP settings, if the user later changes his/her mind for the camera's display position after installation.

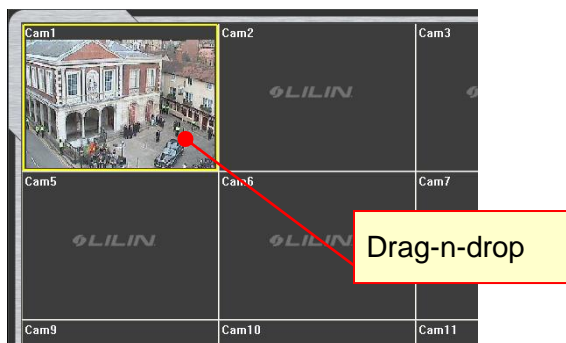

### Chapter 3.9. Digital Zoom

To perform digital zoom, please first drag on the window for digital. Once the channel is in digital zoom mode, please select the green area for other region.



To perform digital zoom in playback, please follow above procedure.

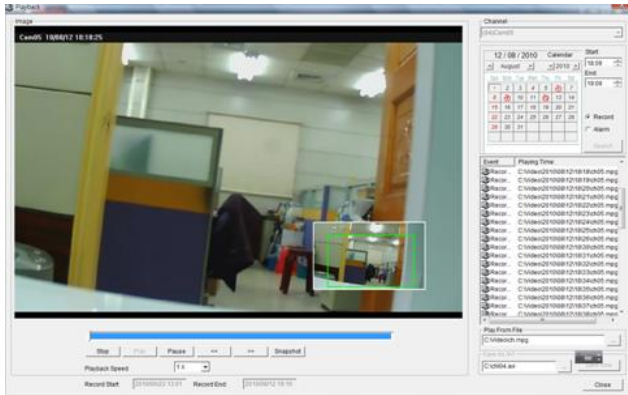

### Chapter 3.10. Two-way Audio

To perform two-way audio, please first select a particular channel for listening to the audio of the channel. Click on Speaker icon to enable audio feature. To change volume, please change volume bar.



To speak to remote site, please click MIC On button.



To enable audio monitoring, please double click on a channel in full screen mode for audio monitoring.

## Chapter 4. CMX Software HD 3.6 Video Playback

CMX Software HD 3.6 can perform video playback task for all IP-based products including H.264 HD IP Cameras, full D1 IP Cameras, IP Fast Domes, Video Servers, LAN Cameras, and DVRs. To perform video playback on various IP devices, follow the following sections:

### Chapter 4-1. Playback

To perform playback operation, you have to select a camera channel or a DVR. By clicking on playback button, the playback dialog box shows up.



Based on a DVR device or an IP camera device, each device of the playback operation is described in the following sections:

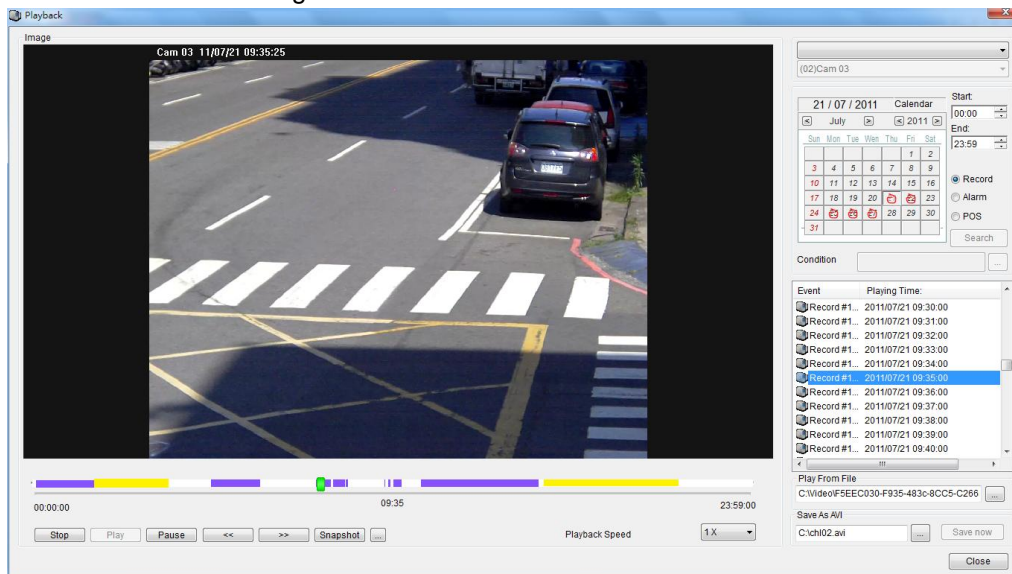

### Chapter 4-2. Playback for a IP Camera within the Main Grouping

For the main grouping, the video can be recorded at a local PC. To retrieve stored video clips, playback operation can be performed based on date and time specified. Please follow the following steps to play video clips on the PC:

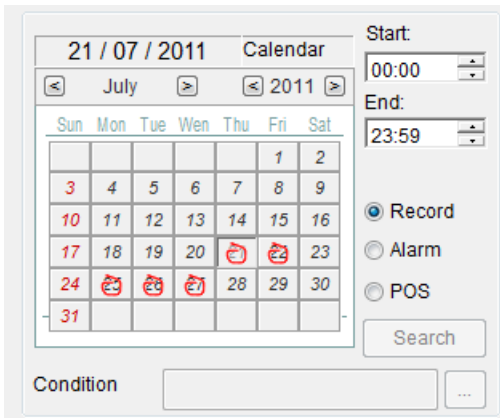

- Step 1. Click on the date on the calendar control.
- Step 2. Specify starting time and ending time.
- Step 3. Click Search button to search the video clips.

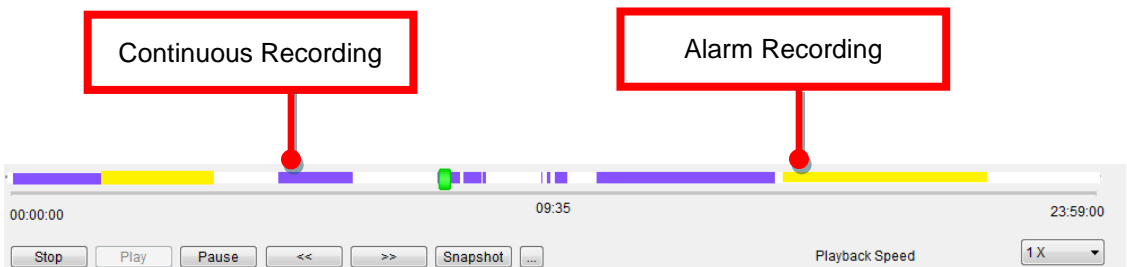

Once a video clip is playing, click on Stop, Play, Pause, <<, >>, and snapshot buttons for the video clip. A user can also click on the time-bar for video playback.

### Chapter 4-3. Remote DVR Playback

For playback on a remote DVR, please first perform right-mouse click on a DVR channel. Select "DVR Remote Playback" menu item for DVR video playback.

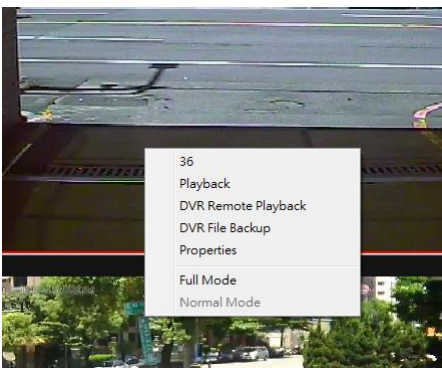

The DVR Playback dialog box shows up. Specify date and time information in the dialog box for remote DVR playback.



#### Chapter 4-4. Remote DVR File Download

To download remote DVR's files, please first perform right-mouse click on a DVR's channel. Select "DVR File Backup" menu item. A DVR File Backup dialog box shows up. Specify date, time information, and click on Search button. It can list all the files of the DVR. For downloading the files, please click on Save Folder button and click on Download button for downloading the files into a specific folder.

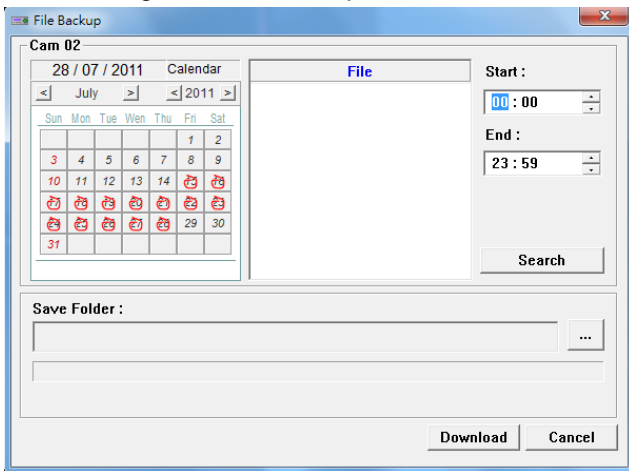

#### Chapter 4-5. AVI File Exporting & Play From a File

##### Exporting AVI with OSD

To export an AVI file for main grouping device, please perform playback operation for the device. Once the video clips have been located, specify the file name and click on Save Now button for the AVI file.

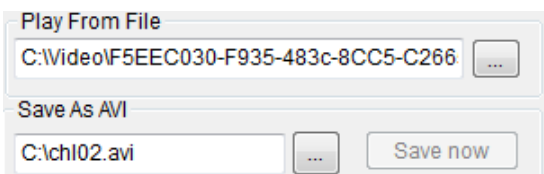



## Exporting AVI without OSD

For direct exporting H.264 AVI file without OSD time stamp, this operation performs fast than rendering OSD.

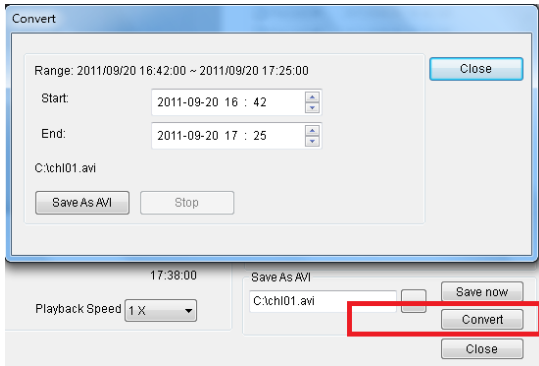

CMX Software HD 3.6 video clips are stored in a hard drive's Video folder followed by a GUID folder. The GUID folder is a 32-digit hex folder. CMX Software HD 3.6's video clips are stored as in the folder under year, month, day, hour, and minute. To retrieve a particular a file, please locate the file by the button of "Play from a File".

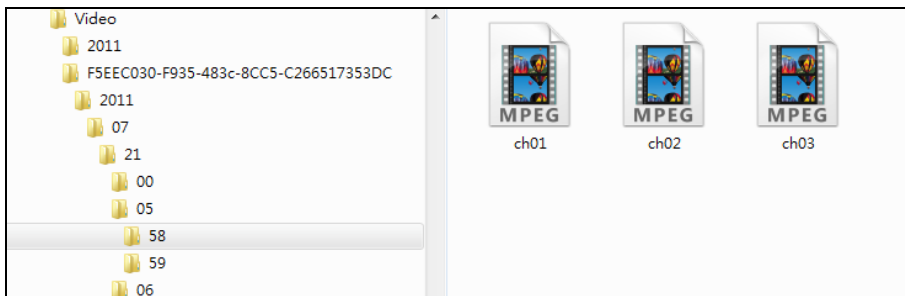

## Chapter 4-6. Snapshot

For IP-based devices, you may want to capture a particular video into a picture. You can click on the Snapshot button. The picture is exported to a JPEG file format. For DVR devices, please perform right-mouse-click and select "Save As JPEG" menu item.

## Chapter 4-7. Alarm Event Playback

To playback based on motion detection events, please click on the alarm radio button at the Playback dialog box. Click on Search button to list all the motion detection events. Click on a motion event can play associated video.

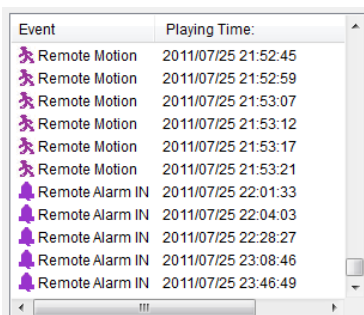

## Chapter 5. User Settings

User setting allows add a user, delete a user, change password for a user, and assign feature accessed by a user.

To add, delete, and modify a particular user, click on User button in NVR tool box.



The User Setting dialog box shows up.

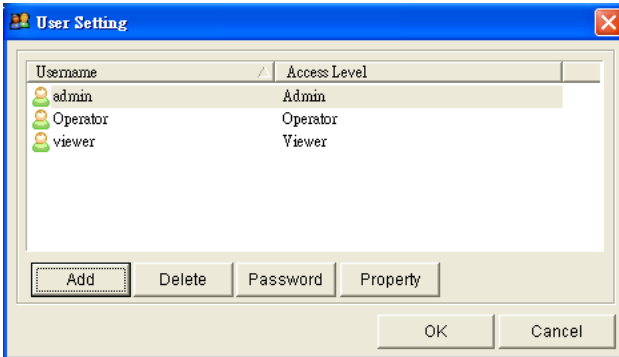

### Chapter 5-1. Add a User

To add a user, click on a particular user in the user list and click Add button. Add User window shows up. To add user, specify user name, password, and confirm password. Please also specify the user level and click on OK button.

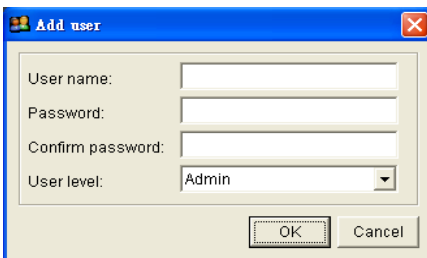

### Chapter 5-2. Modify an Existing User

To modify an existing user, click on a particular user in the user list and click Property button. To modify the user, specify user name, password, and confirm password.

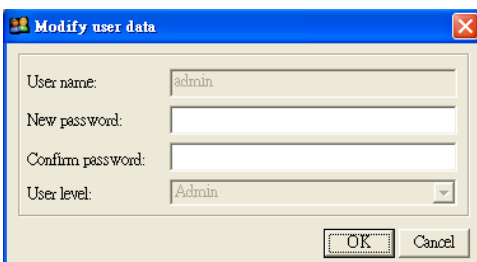

### Chapter 5-3. Delete a User

To delete a user, please select the user in user setting window and click on OK button.

### Chapter 5-4. User Authorization

Features of CMX Software can be assigned for a user. To enable a feature for the user, please first click on Property button. The User Property dialog box shows up. Click on the check box for the user in Access Level list item.

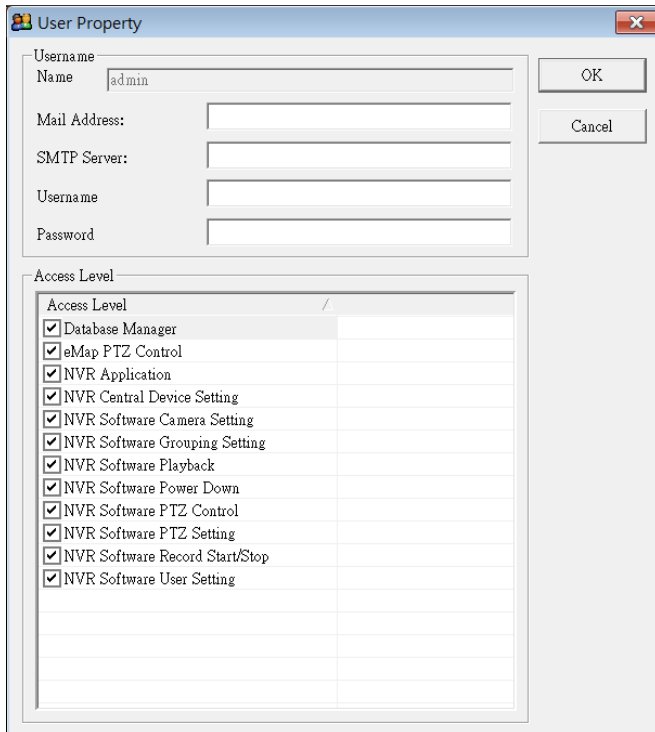

### Chapter 5-5. Alarm Email Notifications

For sending alarm email notifications, please configure the email setting in the user. After finishing email setting, please configure Alarm Output Management at Camera Settings.

## Chapter 6. PTZ Control Panel

In order to perform PTZ movements, you have to select a particular live channel which contains an IP Fast Dome. Once an IP Fast dome is selected, you can control the movements using PC keyboard and/or PTZ control Panel.

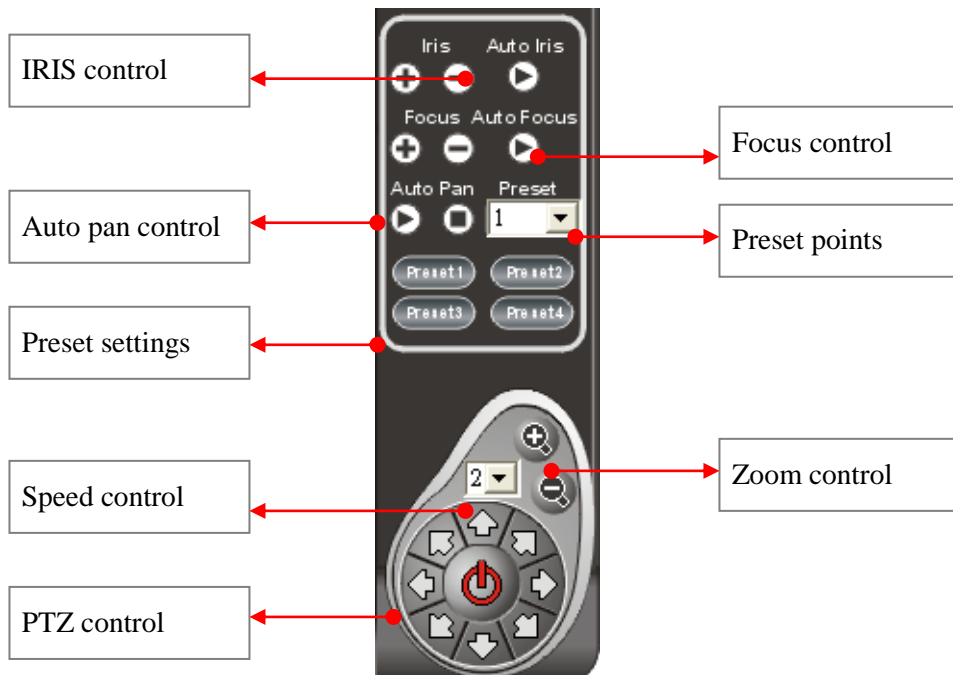

### Chapter 6-1. Preset Point Settings



To setup preset points, please invoke Presets dialog box. Follow the following steps:

- Step 1. Select preset point dropdown list.
- Step 2. Type the time field.
- Step 3. Type the speed field.
- Step 4. Click up, down, left, or right to move the IP Fast Dome to specific position.
- Step 5. Click Apply button to set the position.

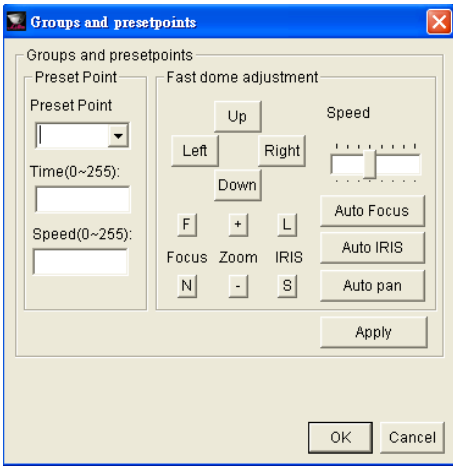

## Chapter 6-2. CMX Software HD 3.6 Status Panel

CMX Software HD 3.6 status panel is described as following chart.

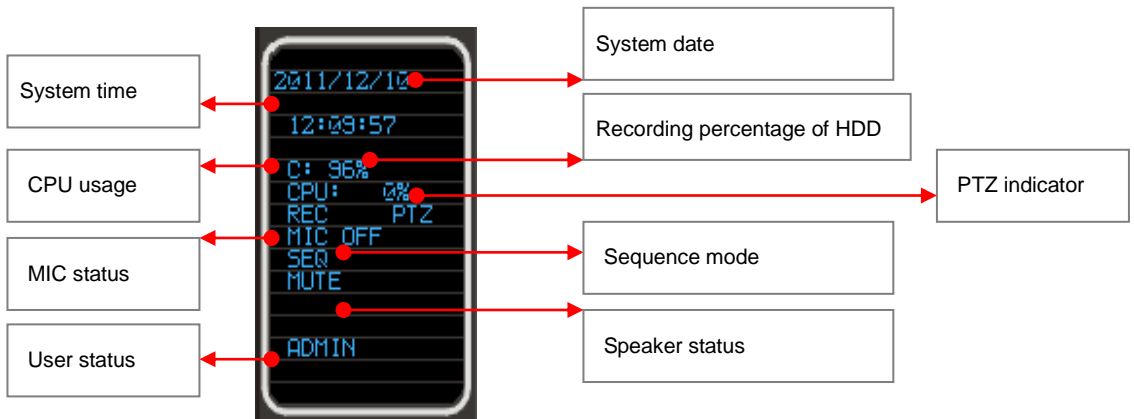

## Chapter 6-3. Control PTZ via PIH-931D Keyboard

To use PIH-931D keyboard for CMX, please follow the following steps. First, please add a RS-232<->RS-485 convertor for connecting PIH-931D keyboard and a CMX PC.

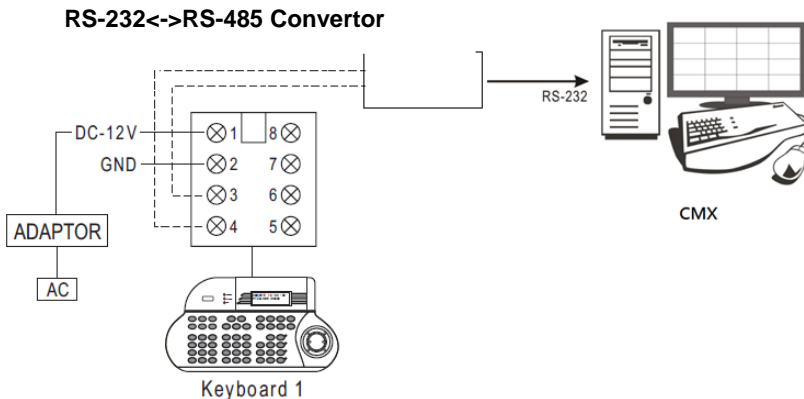

### Chapter 6-3-1. DVR Control Mode

Press the **SHIFT** button and the **DVR** button to set the keyboard to DVR control mode.



To control a CMX, please first enter the DVR ID (CMX ID) follow by the **ENT** button.



To recall a grouping, please type 1 + **MON** and following by grouping ID and the **PRESET** button.

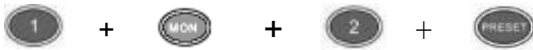

### Chapter 6-3-2. Window-division

To change window-division, please first control a CMX and type the following buttons.

	16-division		8-division	36-division	CMX ID + <b>DVR</b> + <b>ENT</b>
	9-division		4-division		

To recall 36-window-division, please type CMX ID followed by **DVR** and **ENT** buttons. The operation is same controlling a CMX.

### Chapter 6-3-3. Recall a Camera

For recalling a camera, please select camera number and follow by **CAM** button.

#### Example: Call camera #8



	Zoom in		Zoom out
	Tilt up		Tilt down
	Pan left		Pan right
	Zoom in		Zoom out
	Focus near		Focus far

	IRIS small		IRIS large
	Auto Pan		

#### Chapter 6-4. IP Camera ePTZ or ROI Feature

For some IP cameras, they provide ePTZ or ROI feature. A user can still use the keyboard controller for ePTZ or ROI feature via CMX Software HD 3.6.

#### Chapter 6-5. Keyboard Playback

Please press **SHIFT** and **DVR** buttons for playback a CMX. To select date and time, please use Joystick to control the mouse for selection.



To control the CMX, please type CMX ID, **DVR** button and **ENT** button.



For operating playback features, please follow the following:

Pause: Press **PAUSE** button during playing video can pause the video in pause mode.



Play: Replay the video after Pause, Fast Forward, or Fast Rewind.



Fast Forward: Fast Forward the playback video.



Fast rewind: Fast Rewind the playback video.



Stop: Stop the playback video and return to playback menu.



## Chapter 7. eMap Manager

eMap is an application which can manage devices such as IP camera, IP Fast Dome, and DVRs on multiple maps. With eMap Manager, user can easily locate a particular device on a map.



### Chapter 7-1. Before Accessing eMap Manager

Before accessing eMap, terms and screen layout are described in the following section:

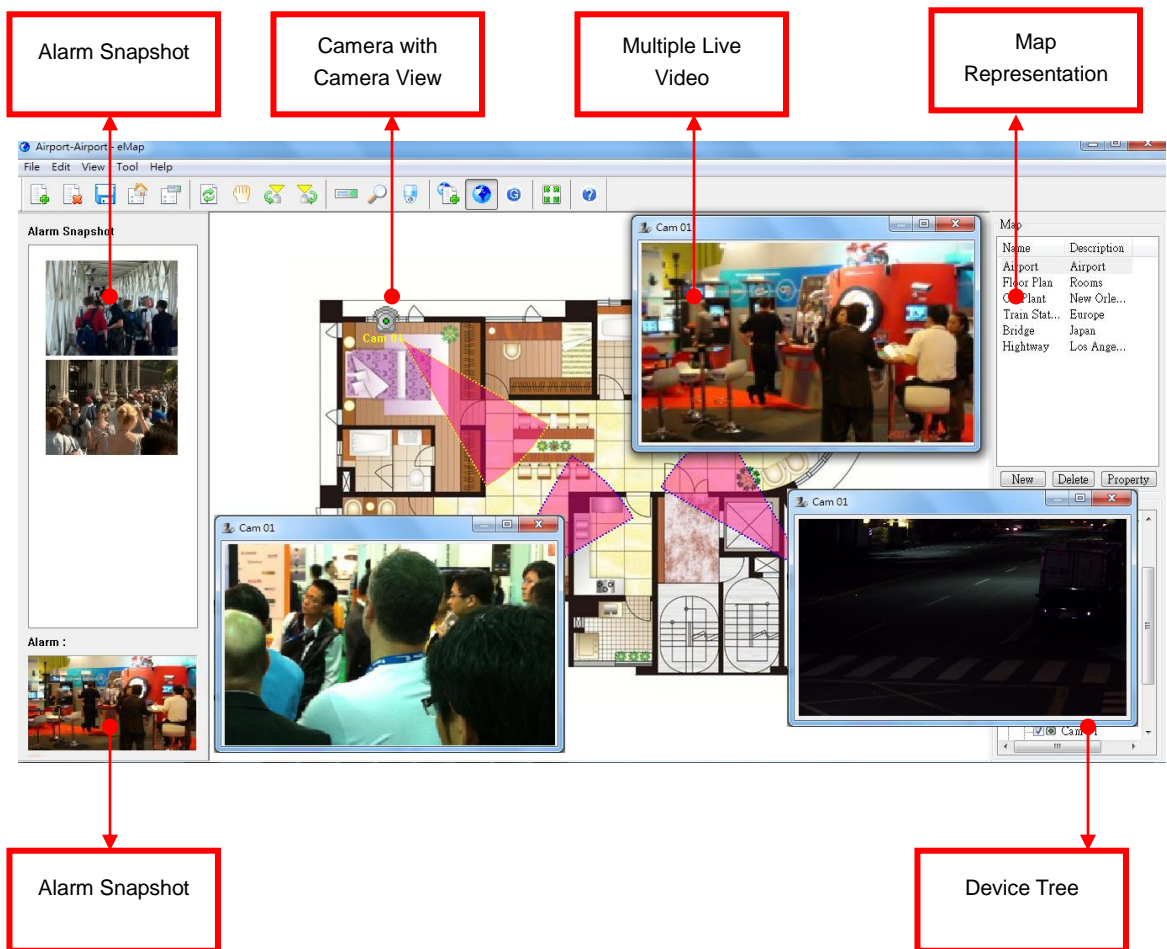

### Find Device Panel

To find a device, please click on Find Device Panel button or View->Device menu. Click on the device in Find Device Panel.





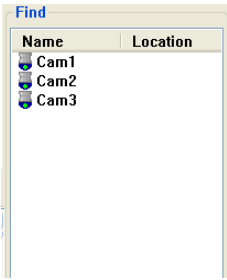

## PTZ Control Panel

To control PTZ device, please double click on a PTZ device. Perform PTZ feature on the PTZ control panel.



## Chapter 7-2. Tool Bar

The buttons from left to right are described as follows:

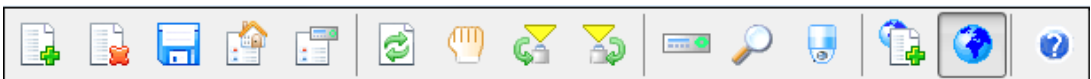

New map: Create a new map.



Delete map: Delete an existing map.



Export map as: Export existing for later use.



Map properties: Set map properties.



Device properties: Set device properties



Refresh: Refresh eMap map list and device information.



Drag device mode: Drag a device on a map for its position.



Camera view control: Clockwise and counter-clockwise rotate a camera view.



Device list panel: Switch to Device panel.



Find device panel: Switch to Find Device panel



PTZ control panel: Switch to PTZ control panel.



eMap edit mode: for editing a map, deleting a map, and setup a device on map.



eMap control mode: for PTZ control and live monitoring mode

### Chapter 7-3. eMap Alarm Options

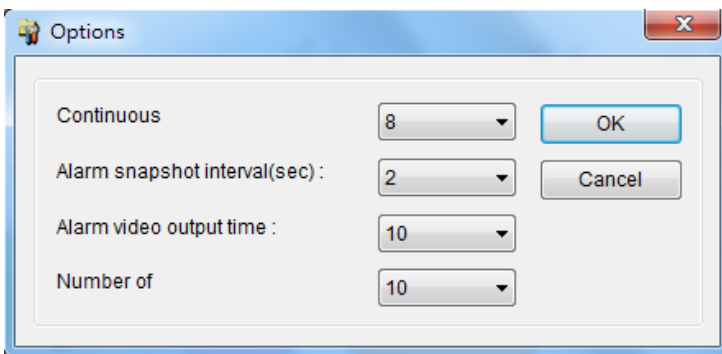

#### Chapter 7-3-1. Setup a Map

To setup a device map, click on File->New Map or New button at Map list. A file opening dialog box gets displayed. Please select the JPEG map file representing the installation site. Type both map name and location information.

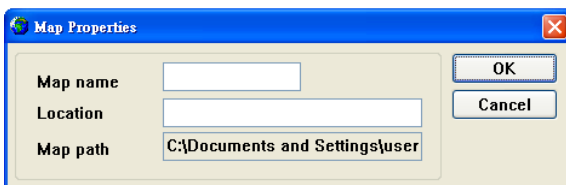

To delete a map, please first select the map in Map List and click on File->Delete Map or click on Delete button.

**Delete**

To access property of the page, click on Property button.

**Property**

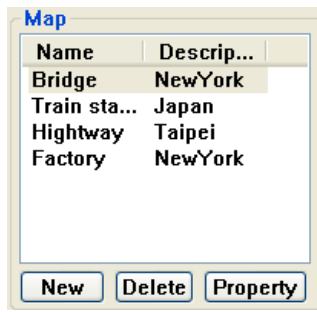

### Chapter 7-4. Setup a Device on a Map

To setup devices on a map, drag-and-drop a device from Device List to its associated map. The device item shows checked if the device is setup on the map.

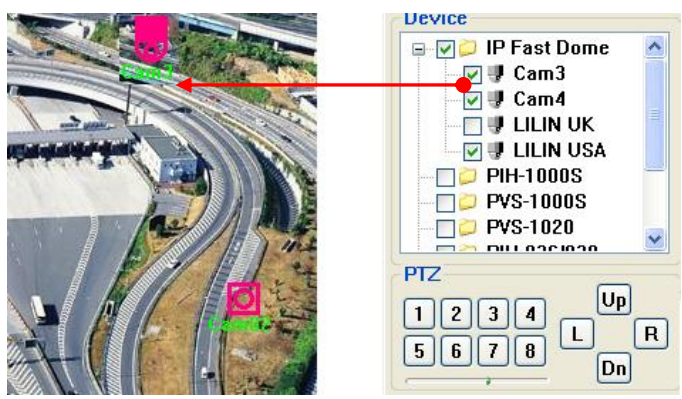

### Chapter 7-4-1. Delete a Device on a Map

To delete the device on the map, follow the following steps:

1. Select on the device.
2. Right click on the device.
3. Select "Device Delete" menu item.

Or, uncheck the check box of the device item.

## Chapter 7-4-2. Arrange a Device



To arrange the device position on the map, click on Drag Mode tool or menu item to enable device drag mode. Use mouse point drag the device to the destination area.



## Chapter 7-4-3. Device Property

To show a Device Property, select "Device Property" menu item on the menu. A Device Property dialog box shows up. Device name and device text color can be changed for distinguishing its background image.

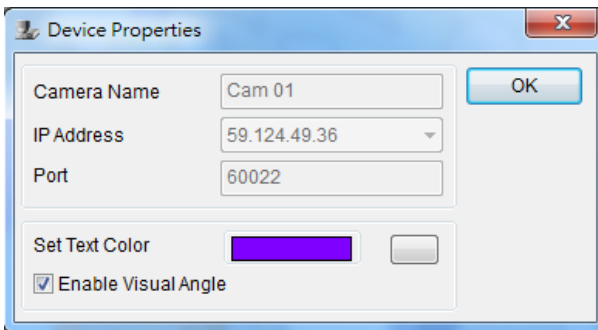

## Chapter 7-5. Find a Device on eMap

DVR, DVR's camera, or IP-based devices can be setup on different maps. It is very difficult for a user to find the live video of a particular device. To find a device on eMap instantly, a user can click on Find Device Panel button/View->Find menu item. List of all devices in Find Device Panel can be found on a map instantly. The user can click on the device that eMap can automatically switch to the map and show the device and its live video.

Device Name

Device  Find

Name	Location
PDR-2160	UK
Cam1	Taipei
Cam2	Taipei
PDR-3160	Taipei

### Chapter 7-6. Camera View Control

A camera view control can indicate a camera's viewing angle. To setup camera view control, please click on the clockwise/counter-clockwise camera view control to rotate camera viewing angle.

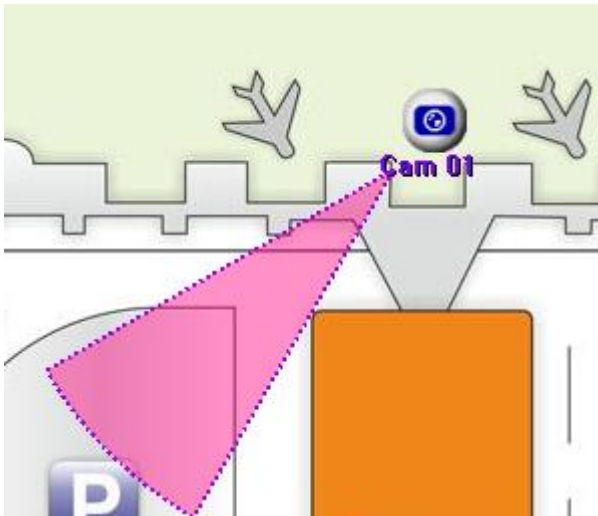

## Chapter 8. Web Server

Each CMX has one web server for displaying live video. To enable the service, please specify the port number of the PC's IP address.

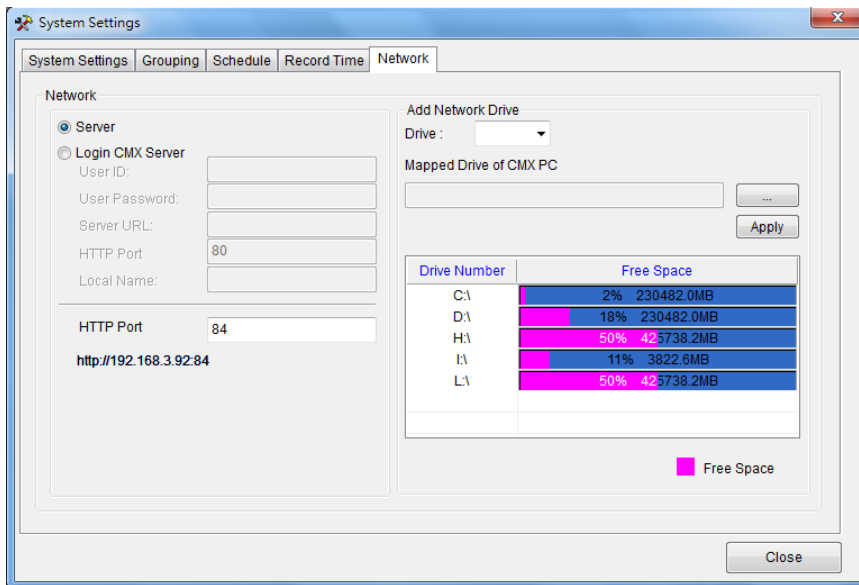

Once this is done, the user can click on the HTTP Link and launch Internet browser to see the video.

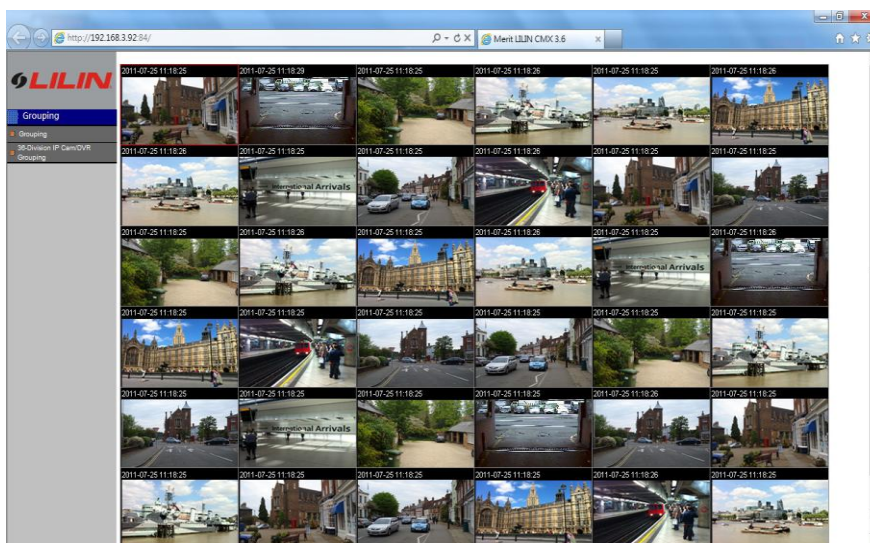

### Chapter 8-1. Login Web Server

To login CMX web server, please provide the username and password for the service. The live video is grouped based on grouping as in CMX Software HD 3.6. Once a grouping is managed, the grouping can be assigned for its access right of a user. Please see grouping section for detail.

## Chapter 9. Database Manager

Database Manager allows a user to perform operational report printing, event report printing, database importing, database exporting, and database repairing.



To perform above features, please see the following:

Date/Time	Event	IP Address	Device Name	Location	Event Report
090312 09:07:10	Alarm		Cam3	Cam3	Alarm
090312 09:07:10	Alarm		Cam3	Cam3	Alarm
090312 09:07:03	Alarm		Cam3	Cam3	Alarm
090312 08:38:47	Alarm		Cam3	Cam3	Alarm
090312 08:38:37	Alarm		Cam3	Cam3	Alarm
090312 08:29:29	Alarm		Cam3	Cam3	Alarm
090312 08:38:18	Alarm		Cam3	Cam3	Alarm
090312 08:38:04	Alarm		Cam3	Cam3	Alarm
090312 08:37:07	Alarm		Cam3	Cam3	Alarm
090312 08:35:38	Alarm		Cam3	Cam3	Alarm
090311 19:49:19	Alarm		Cam3	Cam3	Alarm
090311 19:49:08	Alarm		Cam3	Cam3	Alarm
090311 19:48:57	Alarm		Cam3	Cam3	Alarm
090311 19:48:46	Alarm		Cam3	Cam3	Alarm
090311 19:48:35	Alarm		Cam3	Cam3	Alarm
090311 19:48:23	Alarm		Cam3	Cam3	Alarm
090311 19:48:12	Alarm		Cam3	Cam3	Alarm
090311 19:47:59	Alarm		Cam3	Cam3	Alarm
090311 19:47:48	Alarm		Cam3	Cam3	Alarm
090311 19:47:36	Alarm		Cam3	Cam3	Alarm
090311 19:47:25	Alarm		Cam3	Cam3	Alarm
090311 19:47:14	Alarm		Cam3	Cam3	Alarm
090311 19:47:03	Alarm		Cam3	Cam3	Alarm
090311 19:46:52	Alarm		Cam3	Cam3	Alarm
090311 19:46:40	Alarm		Cam3	Cam3	Alarm
090311 19:46:28	Alarm		Cam3	Cam3	Alarm
090311 19:46:17	Alarm		Cam3	Cam3	Alarm
090311 19:46:06	Alarm		Cam3	Cam3	Alarm
090311 19:45:54	Alarm		Cam3	Cam3	Alarm
090311 19:45:43	Alarm		Cam3	Cam3	Alarm
090311 19:45:31	Alarm		Cam3	Cam3	Alarm
090311 19:45:22	Alarm		Cam3	Cam3	Alarm
090311 19:45:11	Alarm		Cam3	Cam3	Alarm
090311 19:44:28	Alarm		Cam3	Cam3	Alarm
090311 19:44:46	Alarm		Cam3	Cam3	Alarm
090311 19:44:35	Alarm		Cam3	Cam3	Alarm



### Chapter 9-1. User Operational Report



For showing all logon logs, please click on “User Log Report” menu item. To print out the report, please click on “Print/Print Preview” menu item.

### Chapter 9-2. Event Report



For showing all alarm event logs, please click on “Event Report” menu item. To print out the report, please click on “Print/Print Preview” menu item.



### **Chapter 9-3. Database Maintenance**



Database maintenance is constantly required. To perform database maintenance, please click on Tool->Compact DB or click on Compact DB tool button.

### **Chapter 9-4. Import Database**



Database configuration can be imported from a XML configuration file. To import database, please click on Import Database button.

### **Chapter 9-5. Export Database**



Database configuration can be export to a XML file for later use. To perform exporting, please click on Export Database button.



## Chapter 10. Retail and Distribution Business Solutions

CMX Software HD 3.6 is able to connect to Point of Sale (POS) terminals. POS transaction data can be captured by CMX Software HD 3.6. POS transaction data can be displayed on live video and playback video. CMX Software HD 3.6 also provides smart transaction search for associated video clips. To perform these features, please follow the steps below:

### Chapter 10-1. POS Connection Basis for Retail Business

CMX Software HD 3.6 basically listens to the ASCII/COM output of a POS system via RS-232.

Please check POS's display output or printer output for ASCII data of your POS system.

Please consult your POS provider for more detail.

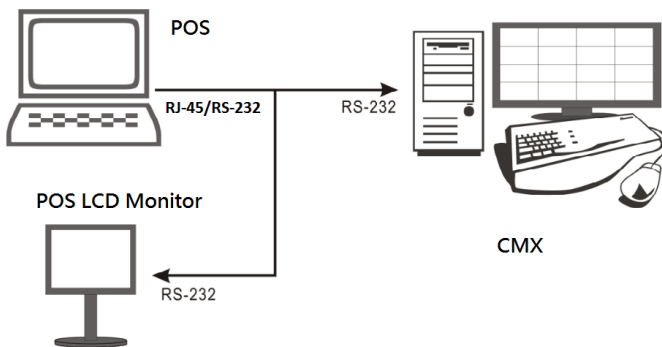
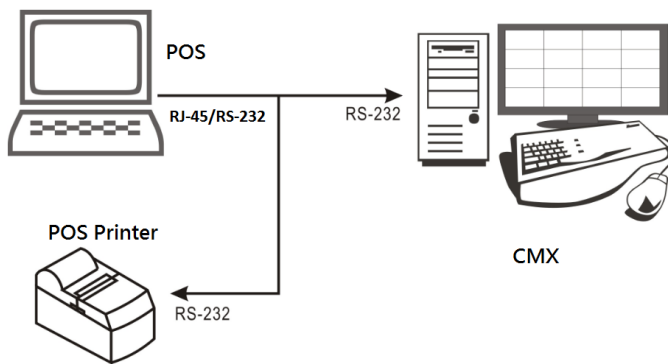

Basically, please connect RX/TX of the RS-232 of a POS register/terminal to CMX PC. Please see wiring diagram below:

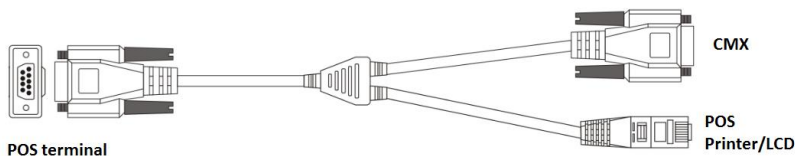

To connect more than one POS terminals, add more RS-232/COM port into the CMX PC.

## Chapter 10-2. Test POS Communication with a PC

After the POS connects to the CMX PC, please use Hyper Terminal or other RS-232 capturing application to test and to verify POS data that can be captured in the CMX PC.

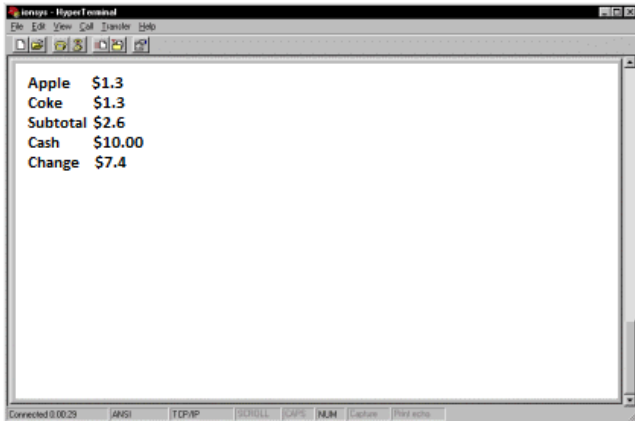

## Chapter 10-3. Link POS with a Channel

To link a POS to a camera, please click on "Property" button and "POS" button. The POS Setting dialog box shows up.

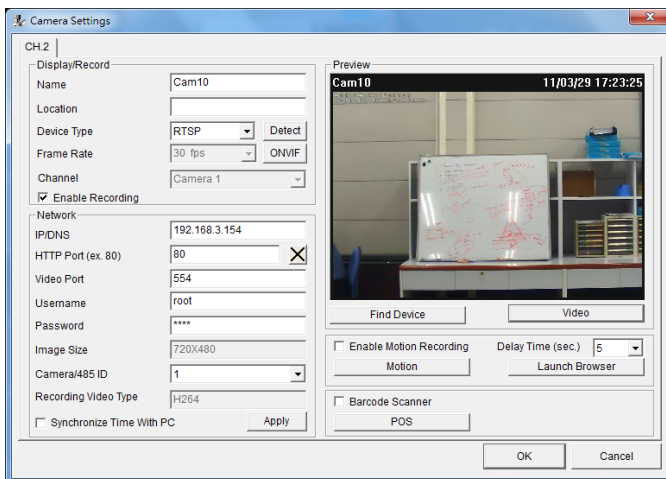

In POS Setting dialog box, please specify the following information for capturing POS transactions.

- (1) Device: POS register number.
- (2) COM Port: The mapped COM port number for the POS terminal.
- (3) Print on Video File: Record POS transaction into video file.

- (4) Print on Playback: Display POS transaction during playback.
- (5) Print on POS Live: Display POS transaction at live video.
- (6) Text Alignment: Alignment of POS transaction.

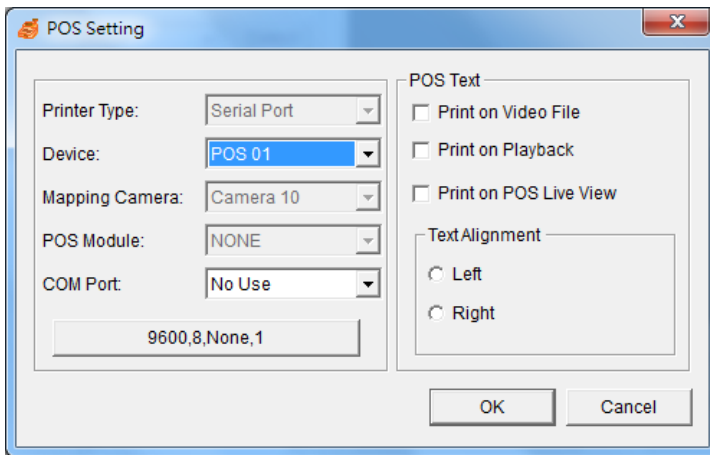

Once above information is setup correctly, CMX Software HD 3.6 starts to capture and to display POS transactions on live video.



**Note:** For demo purpose, please press F3 to show simulated POS transitions.

#### Chapter 10-4. Playback with POS Transactions

During playback, the recorded POS transactions get shown on the video and displayed on the list box. Click on a POS transaction. The video clip is played associated with the time of the POS transaction.

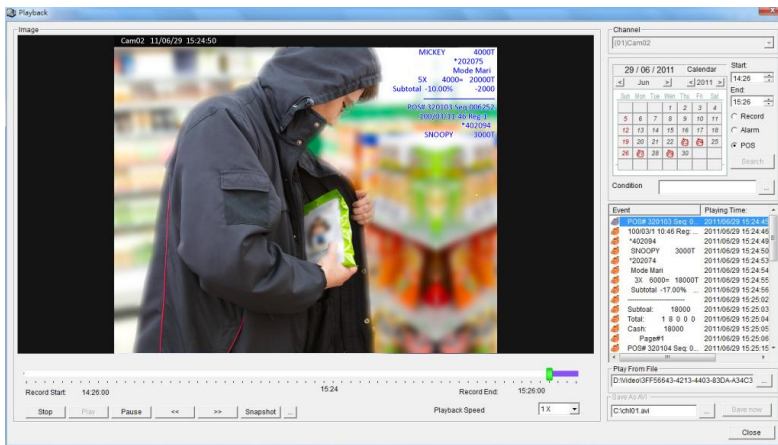

### Chapter 10-5. Search POS Transactions

Too search a particular search conditions such as an amount, a product item, subtotal, and total, a user can set the search condition for associated time stamp. Click on the item in the listbox. It can play the video of the transaction.

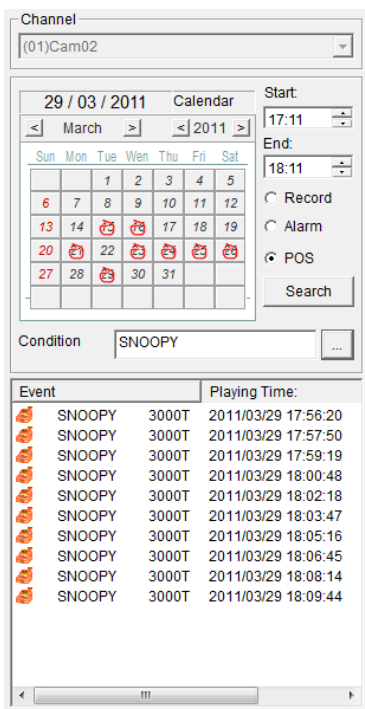

### Chapter 10-6. Scanner Connection Basis for Transportation Business

For transportation business, a barcode scanner and a keyboard are widely used. The barcode scanner for scanning barcode is connected to a PC via the PS/2 connector of the CMX PC. The barcode scanner acts as a keyboard. In CMX Software HD 3.6, the scanner connection only accepts 0 to 9 for keyboard scanner or the barcode scanner.

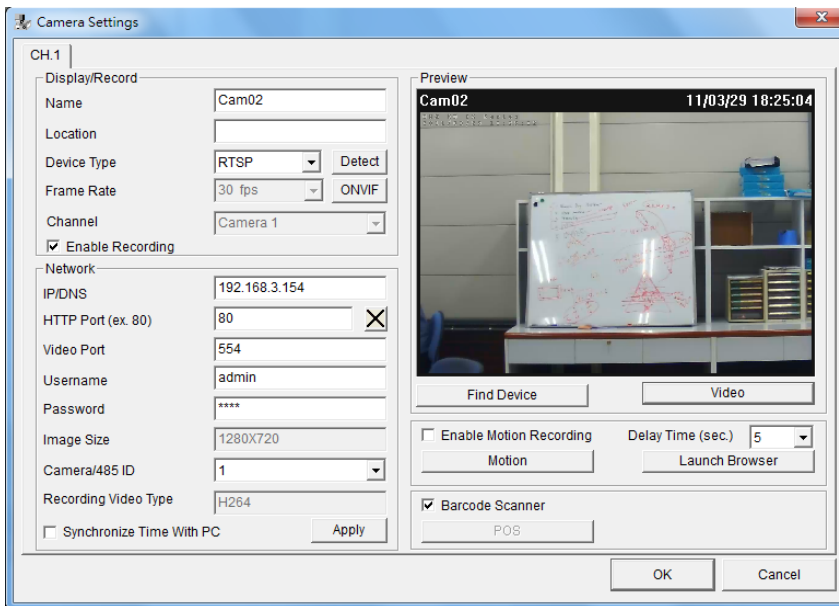

To use barcode scanner as transaction device, connect barcode scanner into PS/2 connector. In “Camera Settings” dialog box, enable “barcode scanner” option. For one PC, there is only one video channel that can be set for the barcode scanner.

For search barcode transactions and playback on the barcode transaction, please see “Playback with POS Transactions” and “Search POS Transactions” for detail.

## Chapter 11. Mobile Phone Support

### Chapter 11-1. iPhone and iPad support

Please use your iPhone and select AppStore for download Live Cams Pro application developed by Eggman Technologies.

Execute Live Cams Pro application. Please click on “Add Camera” button on your phone while using Live Cams Pro. Task bar gets prompted as below:



Please select one of the following cameras or DVRs type :

LILIN NVR: NVR104/108/116/CMX driver.

Please provide the following information:

1. Name: IP Camera or DVR's camera name
2. Host or IP: IP address or DNS address
3. Port: Port number
4. Provide username and password information. For IP camera, the default username and password are “admin” and “pass”. For DVR, the default username and password are “admin” and “1111”.

Once above information is entered, please click “Save” button. You are able to see live video of the IP camera or DVR's camera.



## Chapter 11-2. Android Support

Please use your Android phone and select Android Market for download Live Cam Viewer application developed by Robert Chou.

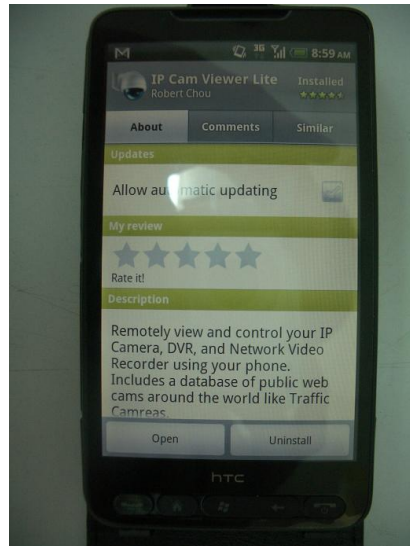

Execute Live Cam Viewer application. Please click on Setup button on your phone while using Live Cam Viewer. Task bar gets prompted as below:



Please click on Manage Cameras button. A list of camera names shows on the screen. Please select one of the cameras and click on Edit button.



“Add/Edit IP Camera” dialog box gets prompted for editing of an IP camera or a DVR.



In “Add/Edit IP Camera” dialog box, please enter the following information:

1. Name: Name of the IP camera or DVR’s camera
2. Category: Please select Merit LILIN.
3. Type: Select device type, Merit LILIN D1/Merit LILIN HD/Merit LILIN DVR.
4. IP Address: Please type IP address, for example <http://59.124.49.36:60005> where 60005 is the port number.
5. Provide username and password information. For IP camera, the default username and password are “admin” and “pass”. For DVR, the default username and password are “admin” and “1111”.

Once above information is entered, please click “Save” button. You are able to see live video of the IP camera or DVR’s camera.





## Chapter 12. Trouble Shooting

### Chapter 12-1. What should I do if I experience video flickering in CMX

If you experience video flickering at CMX of the PC's graphic card, please follow the instruction for solving the problem.

Step 1: Please go to “Control Panel->System and Maintenance->System Properties” at Windows 7.

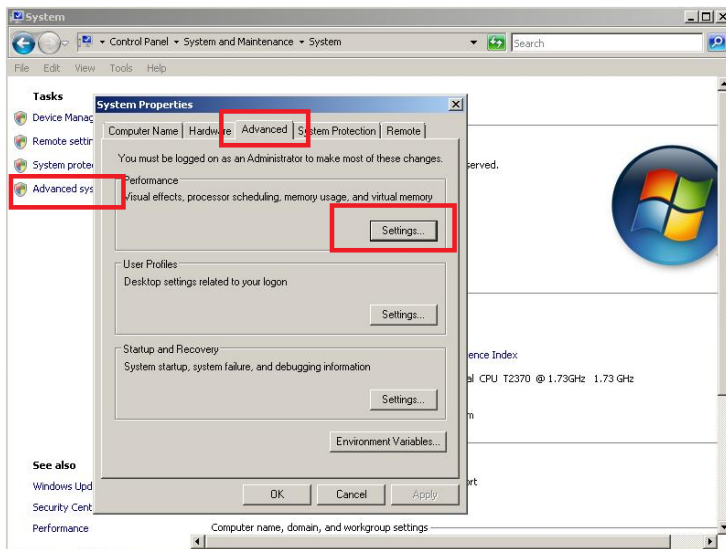

Step 2: Click on “Performance Setting” button and select “Adjust for best performance” option. It can solve the flickering problem.

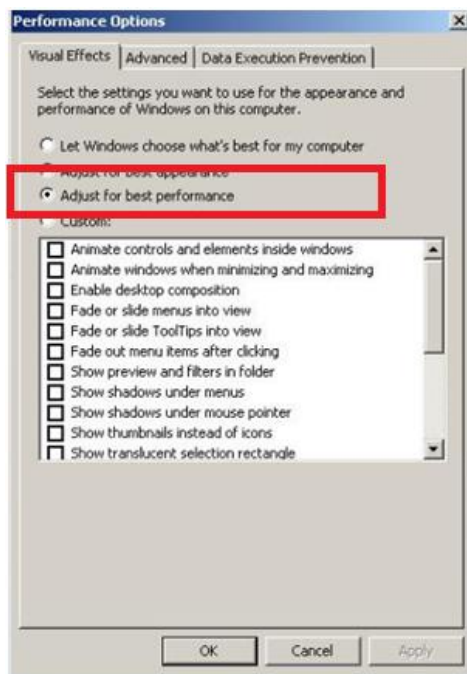

## APPENDIX

### System Requirement

- OS: Windows XP Home, Windows Vista Home, SP3 required, Windows 7 Home
- CPU: Minimum Intel Duo CPU 2.0 GHz or above
- RAM: 4 GB DRAM or above
- HDD Size: At least 250 GB for recording storage
- Network: Gigabit network

### Product Supported

- H.264 D1 IP Camera: IPS203/IPS212, IPS025/030/035, IPS125/130/135, IPR454X
- H.264 HD IP Camera: IPR31ESX, IPD112ESX, IPG012ES, IPR414ES, IPR614ES, IPR712S, IPD012
- H.264 1.3 MP IP Camera: IPR31MX, IPR712M,
- Full HD IP Camera Series: IPR733, IPR434, IPR742, IPR742, IPR722S, IPD320ESX, IPG1022, IPG1052, IPD2220
- Video Server: VS012
- DVR/NVR: PDR-400IP, DVR304, DVR308, DVR316, DVR508, DVR516, NVR104

### Username and password

Default username and password for various devices are described as in the table:

Device	Admin	Admin pass.	Oper	Oper pass.	Guest	Guest pass.
IP Cameras	admin	pass	None	None	guest	guest
DVR/NVR	admin	1111	None	None	guest	2222
CMX Software	admin	EMPTY	operator	EMPTY	guest	EMPTY

### Benchmark Environment:

PC network card—Gigabit network card  
Gigabit hub \* 1

## H.264 benchmark table

	Intel Core i7-2630QM 2.00GHZ RAM: 8 GB DDR III	CPU model: Intel i7 Quad-Core 2.93GHZ RAM: 2 GB DDR III		CPU model: Intel T5750, 2GHZ DuoCore RAM: 3 GB DDR II 677	
	OS: Windows 7, 64 bit	OS: Windows 7, 64 bit, SP1		OS: Windows XP SP1	
	H.264 (1920X1080) 30 FPS	H.264 (720X480) 30 FPS	H.264 (1280X768) 15 FPS	H.264 (720X480) 30 FPS	H.264 (1280X768) 15FPS
Channel	CPU Usage	CPU Usage	CPU Usage	CPU Usage	CPU Usage
2	25%	1%	3%	22%	15%
4	30%	2%	3%	41%	34%
6	40%	3%	9%	55%	37%
8	50%	5%	19%	63%	55%
10	65%	9%	21%	80%	64%
12	75%	9%	26%	87%	84%
14	Overloading	9%	28%	94%	100%
16	Overloading	9%	35%	100%	Overloading
18	Overloading	9%	50%	Overloading	Overloading
20	Overloading	11%	77%	Overloading	Overloading
22	Overloading	12%	84%	Overloading	Overloading
24	Overloading	17%	85%	Overloading	Overloading
26	Overloading	20%	85%	Overloading	Overloading
28	Overloading	24%	100%	Overloading	Overloading
30	Overloading	25%	Overloading	Overloading	Overloading
32	Overloading	31%	Overloading	Overloading	Overloading
34	Overloading	40%	Overloading	Overloading	Overloading
36	Overloading	48%	Overloading	Overloading	Overloading

## CMX 3.6 HD Software Specification

Recording	Schedule / Motion detection / Manual recording
Live	Current 36 channels display/720 channels in total
Speed	Up to 1080P 30 FPS and ROI recording supported
Resolution	1080P / HD 1280 * 768 / D1 720 * 480 / VGA: 640 * 384 / CIF 320 * 240 / CIF: 320 * 192
Schedule	7 day * 24 hrs time table, recording mode configurable
Alarm recording	Face detection, audio detection, tampering, motion, DI alarm detection
Audio recording	Yes
Playback	Time search, event search, date search, POS smart search
Speed	FR: 2x, 4x, 8x, 16X 32X / FF: 2x, 4x, 8x, 16X, 32X
Compression	H.264 / JPEG
Video Input	Unlimited Merit LILIN IP cameras / DVR connections
Camera name	20 characters
Channel editing	Mouse drag-n-drop
Digital zoom	Yes, ePTZ supported
Grouping	User grouping authentication assignable for eMap, and CMX Software HD 3.6
Multiplexer	Sequence
Split screen	4, 9, 16, 36
Alarm	
Alarm management	PC sound, redirect IP camera DO, eMail snapshots, redirect a PTZ preset recall
Event	Various alarm log, video loss, stop recording, schedule, logon, operation log
Digital output	Controllable
Accessories	
P/T/Z protocol	LILIN PTZ controllable via HTTP
Audio	PCM/G.711, two-way audio, audio recording
POS/barcode Scan	RS-232/PS/2
Keyboard	PIH-931D keyboard controllable via RS-485 for PTZ, ePTZ, and ROI features
eMap	
eMap live monitoring	One channel for IP camera/multi-channel for DVR
eMap snapshot	Yes
PTZ control	Yes
DB Manager	
Database	Database configuration import, export, report, and maintenance
Remote Manager	Remote device configuration
Device status monitoring	Schedule remote device status monitoring
Backup	
	DVR remote backup, AVI conversion and JPEG snapshots
Management	
Access log	Complete access log in database manager
User management	User authentication: three level: admin, operator, and guest, features configurable
Recording calculator	Yes, dynamically calculating available recording days
Network	
Web interface	Live web interface
Mobile support	iPhone and Android
Protocols	ARP / TCP/IP / HTTP / SMTP / DNS / PPPoE
IPScan	Supported, easy-to-setup for IP address
Other	
DST	Daylight saving time by Windows OS
OS	Windows 7 Home, Windows Vista Home, and Windows XP Home
Language	English, Chinese, Spanish, French, Italian, Japanese, Russian, Portuguese, Simplified Chinese, and German
CPU requirement	Minimum Intel Duo CPU 2.0 GHz or above
RAM requirement	4GB memory

