



Part 1: System Overview And Installation

Installation and cabling
(for the **installer**)

Part 2: Start-Up And Configuration

Software and network
(for the system administrator)

Part 3: Operating Manual

Modules and remote stations
(for the user)

HiRes

3 Megapixel

2048 x 1536
Software zoom

Skyline

Format free

Each image format
freely definable

30 Frames/s

VGA (640 x 480)
30 F/s Mega

Virtual PTZ

Digital pan, tilt,
zoom

Backlight

Safe using CMOS
without mechanical iris

Internal DVR

Internal via Flash,
external via Network

Win/Lin/Mac

Recording

via Network on PC
up to 1 Terabyte

Microphone & speaker

Audio

bi-directional via IP,
variable frame rates

SIP-Client with video

IP Telephony

Alarm notify,
cam remote control

VideoMotion

Multiple windows
precision pixel-based

-22 to +140 °F

Weatherproof

-30 to +60 °C, IP65,
no heating necessary

IEEE 802.3af

PoE

Network power
even in winter

Robust

No moving parts
fiber glass housing

Mac/Win/Easy

Licence free

Video-Management-
Software

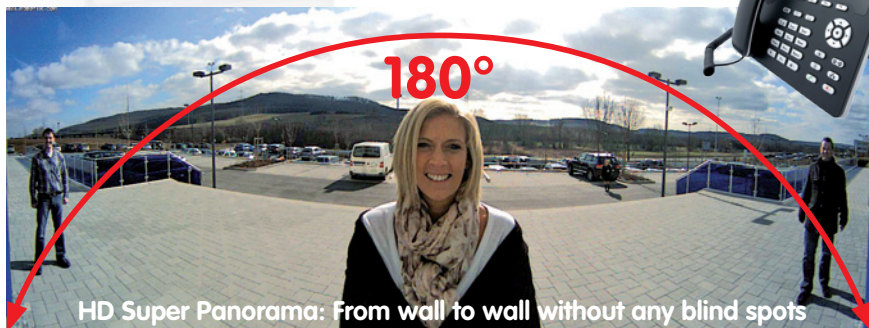

HD Super Panorama: From wall to wall without any blind spots

HiRes Video Innovations

The German company MOBOTIX AG is known as the leading pioneer in network camera technology and its decentralized concept has made high-resolution video systems cost efficient.

MOBOTIX AG • D-67722 Langmeil • Tel: +49-6302-9816-103 • Fax: +49-6302-9816-190 • sales@mobotix.com



Hemispheric Camera

- Allround view with no blind spots
- Internal memory
- Speaker
- Microphone



Keypad

- Keyless access (RFID and PIN)
- Operate voice mailbox
- Contact remote stations
- Incl. RFID transponder cards



Info module/Mx2wire info module

- With integrated **Mx2wire** unit (optional)
- Data and power (PoE) via two-wire connection
- Instead of connection via network cable
- For two-wire cables up to 500 m



Security Door Opener

- Opens door, doorbell on/off
- Status LEDs for door and messages
- Backup power supply with battery
- Connects to door opener and sensors

SYSTEM MANUAL PART 1 - SYSTEM OVERVIEW AND INSTALLATION

This T24 System Manual Part 1 (system overview and installation) is complemented by T24 System Manual Part 2 (start-up and configuration). If you no longer have a manual at your disposal, you can download a PDF file from the MOBOTIX website (www.mobotix.com > Support > Manuals).

Foreword	8
Hemispheric IP Video Door Station	10
Allround View With No Blind Spots	12
Overview Of Modules	14
Individual Components: Outdoors	16
Individual Components: Indoors	18
Configuration Examples	20
System Image	22
1 System Overview	24
1.1 Outdoor Station	24
1.1.1 Hemispheric Camera	24
1.1.2 Ethernet Terminal Board	26
1.1.3 Keypad	28
1.1.4 Info Module	30
1.1.5 Mx2wire Info Module With Indoor Unit (Set)	32
1.1.6 Housing And Module Frames	36
1.2 Security Door Opener	42
1.3 Remote Stations	44
1.3.1 Grandstream IP Video Telephone GXV3140	44
1.3.2 MxEasy Video Management Software	46
1.4 Accessories	48
1.4.1 NPA-PoE Set	48
1.4.2 IO Module (Extended Terminal Boards)	49
1.4.3 Additional Devices For PoE Power Supply	50
1.4.4 Additional Video Remote Stations	51
1.4.5 Door Sensors	51
1.4.6 Electrical Door Opener	51

2	Installation	52
2.1	Overview: Connection And Wiring Diagrams	52
2.1.1	T24 With A Security Door Opener	52
2.1.2	T24 Without A Security Door Opener	54
2.1.3	T24 With Mx2wire And Security Door Opener	56
2.1.4	Recommendation For Cabling	58
2.1.5	Installation Tip: Replacing An Existing Doorbell With The T24	60
2.2	Remote Stations And Network Connection	62
2.2.1	Notes On Cable Lengths And Power Supply	62
2.2.2	Direct Connection Of One Remote Station	62
2.2.3	Network Connection With Multiple Remote Stations	63
2.3	Mounting The Frame And Housing	66
2.3.1	Determining The Installation Position	66
2.3.2	Inserting All The Cables	68
2.3.3	Attaching The Housing	70
2.3.4	Cabling In The On-Wall Housing	72
2.3.5	Mounting The Terminal Board And Fitting The Network Cable	74
2.3.6	Sticking The Seal In Place	75
2.3.7	Attaching The Frame And Connecting The Anti-Theft Protection	76
2.3.8	Mechanical Anti-Theft Protection Lock	78
2.4	Installing The T24 Modules	80
2.4.1	Installing The Camera Module	80
2.4.2	Installing The Keypad	84
2.4.3	Installing The Info Module	88
2.4.4	Installing The Mx2wire Info Module	90
2.4.5	Labeling Info Module And Mx2wire Info Module	92
2.4.6	Removing And Exchanging Modules	94
2.5	Installing The Security Door Opener	96
2.5.1	Overview Of Connectors	96
2.5.2	Connection Diagrams For Door Opener Versions	98
2.5.3	Mounting Instructions	100
2.5.4	Installation Using Cavity Or In-Wall Socket	103
2.6	Installing The Mx2wire Indoor Unit	106
2.6.1	Overview Of Mx2wire Technology And Connectors	106
2.6.2	Mounting Instructions	108
2.6.3	Installation Using Cavity Or In-Wall Socket	109
2.6.4	Installation With Surface-Mounted Socket	111
2.6.5	Function Of Mx2wire Status LEDs	113

2.7	Connecting External Devices To The Door Station	114
2.7.1	Using The IO Module (MX-OPT-IO1)	114
2.7.2	Using The Keypad Signal Outputs	118
2.8	Finishing The Installation	120
2.8.1	Checking The Wiring And Activating The Anti-Theft Protection	120
2.8.2	Configuring The Security Door Opener	122
2.9	Installation In The Siedle Vario System	124
2.9.1	Integrable Modules	124
2.9.2	Determining The Installation Position	128
2.9.3	Preparing Network And Power Connections	129
2.9.4	IO Module And Terminal Connectors	130
2.9.5	Connections In The Door Station	132
2.9.6	Connecting, Securing And Removing Modules	138

Notes

Download the latest version of this manual as a PDF file from www.mobotix.com (Support > Manuals). **All rights reserved.** MOBOTIX® and MxEasy™ are registered trademarks of MOBOTIX AG. Microsoft, Windows und Windows Server are registered trademarks of the Microsoft Corporation. Apple, the Apple logo, Macintosh, OS X and Bonjour are trademarks of Apple Inc. Linux is a trademark of Linus Torvalds. All other marks and names mentioned herein may be trademarks or registered trademarks of the respective owners. Copyright © 1999-2011 MOBOTIX AG, Langmeil, Germany. Information subject to change without notice!

More information:
www.mobotix.com



Important Notes

Electrical Installation

Electrical systems and equipment may only be set up, changed and maintained by a qualified electrician or under the management and supervision of a qualified electrician in accordance with electrotechnical regulations.

Legal Aspects Of Video And Audio Recording

When using MOBOTIX products, privacy and data protection regulations regarding video and audio recording must be observed. Depending on the country and installation site of the IP Video Door Station, the recording of video and audio data may be subject to special constraints or may be prohibited. All users of MOBOTIX products are therefore requested to inform themselves of and comply with all currently applicable regulations. MOBOTIX AG will not assume any responsibility for product use that does not comply with the local laws.

Network Security

MOBOTIX products combine all necessary configuration options for operating in Ethernet networks in a manner that complies with data protection regulations. The operator is responsible for the data protection concept across the entire system. The necessary basic settings to prevent misuse can be configured in the software and are password protected. This prevents unauthorized access by unknown parties.

Risk Of Overheating When Exposed To Direct Sunlight

When mounting black, dark gray or amber-colored T24 IP Video Door Stations in locations where the device is exposed to direct sunlight, the housing temperature can exceed the maximum allowed temperature limit.

This can result in electronic failures and injuries especially when touching exterior metal parts. If the intended use of the device is at an (unprotected) outdoor location, you should only install white or silver-colored modules and frames.



Do Not Remove Lens Cover

The camera module of the door station may not be operated without the installed transparent lens cover. The camera is no longer weather-proof when operated without the lens cover; the removal of the cover exposes the metal ring around the lens, which is especially prone to overheat in high temperatures. Therefore, anyone who touches the ring with their bare hand is at risk of being burned.



FOREWORD

Dear MOBOTIX customer,

Congratulations on your decision to purchase an exceptionally versatile and innovative IP Video Door Station "made in Germany." **The T24 system contains a hemispheric door camera with a 3.1 megapixel color sensor and captures the entire room 180° from wall to wall and from floor to ceiling without any blind spots.**



Chapter 1 of the System Manual Part 1 contains all product details and the technical information of the system. Chapter 2 deals with the installation of the T24 with a direct network connection or using the Mx2wire system for connection via two wires. Part 2 of the System Manual will demonstrate how you operate the T24 and configure it to meet your specific needs. The two System Manuals are supplemented by an Operating Manual for the T24 IP Video Door Station.

If you would like to use a computer for the installation or as a remote station, make sure to use the free MOBOTIX operating software MxEasy. You can download MxEasy and its manual free of charge under "Support" on the MOBOTIX website.

If you have any questions, our support and international sales staff are available at intl-support@mobotix.com and sales@mobotix.com Monday to Friday, 8 a.m. to 6 p.m. (German time). Calling support is free of charge (not including your connection costs).

We would like to thank you for your trust and wish you all the best with your new high-performance MOBOTIX T24 IP Video Door Station.





More security thanks
to a maximum overview

What Are The Specific Advantages Of A MOBOTIX IP Video Door Station?

The new T24 IP Video Door Station from MOBOTIX offers an innovative, powerful solution that is easy to install and takes a different approach to the solutions available on the market up to now. The T24 is based on the international video telephony standard VoIP/SIP with H.264 and G.711. All of the modules offered for outdoor use are weatherproof, maintenance-free and can be used in temperatures ranging from -30°C to +50°C (-22°F to 122°F). Here are the most important system advantages at a glance:

Allround View With No Blind Spots

With 3.1 megapixels and an internal memory, this hemispheric door camera records the entire entrance area. No blind spots from wall to wall and from floor to ceiling.

Two-Way Video Communication Worldwide

When the doorbell rings, a connection is established with an IP video phone or a standard computer via the network. For two-way video communication and for opening the door.

Recording With Sound

The camera in the door station can record events automatically. For example, when someone rings the doorbell or if something moves in front of the door.

Keyless Access

Who has access and who doesn't? The door opener can be controlled tamper-proof using the keypad with a PIN code or an RFID transponder.

Integrated Message Function

Digital voice messages for residents can be left directly at the door station and played back after authentication.

Very Simple Installation

The door station is connected to the network via an Ethernet cable or via two-wire cabling thanks to Mx2wire technology.

The T24 modules are available individually or in a set



MOBOTIX integrates hemispheric technology into existing Siedle Vario Systems for added security thanks to superior overview images and event-controlled recording of video and sound.

© MOBOTIX AG • Security-Vision-Systems • Made in Germany

www.mobotix.com • sales@mobotix.com



Fisheye view

What Advantages Does MOBOTIX Offer Over Other Video Door Stations?

Thanks to its HiRes image quality, decentralized technology and a wide range of features, MOBOTIX offers not only an outstanding door camera but also a professional security camera in a single device. **MOBOTIX Hemispheric Video Technology** was successfully introduced to the network video market in 2008. This technology is an important component of the MOBOTIX video door stations, which provide perfect, high-resolution overview images thanks to a fisheye lens with a 180° image angle. This allows the camera to cover the entire entrance area from wall to wall and from floor to ceiling without any blind spots, and without ever needing to mechanically pan or tilt.

But the camera, with its unrivaled image quality and panoramic view, is much more than just a modern "door spy." The camera has an integrated high-speed processor that provides a range of functions similar to those available in MOBOTIX security cameras used in banks and airports. Thanks to the **integrated Video Motion Detection**, when the camera registers movement in the image or detects suspicious noises, it automatically starts recording **smooth video with sound** while simultaneously sending an **e-mail or SMS** to the residents of the building or to a security company.

In addition, a **message may be left for the residents** at the door station; it works just like a telephone answering machine with the addition of video and audio recording by the camera module. Additionally, an **audio message for visitors** can be played back automatically when the doorbell button is pushed.

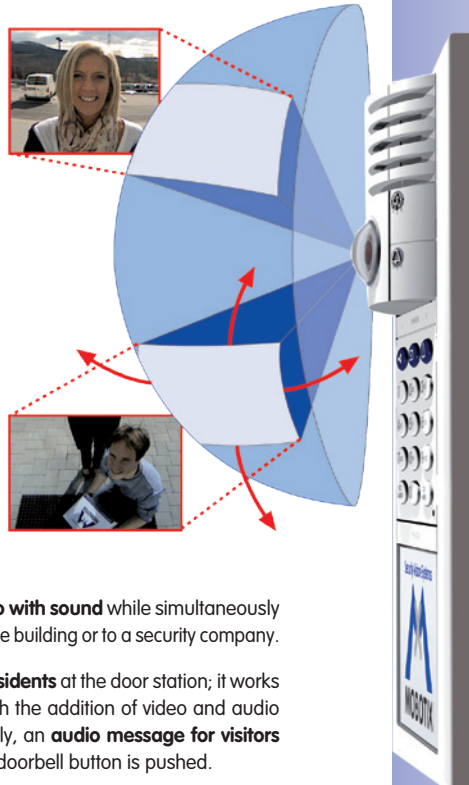

HD Super 180° Panorama

The camera captures the entire hemispherical area in front of the camera lens and displays it in a user-friendly format as a corrected image or image section, or as an HD Super 180° panorama

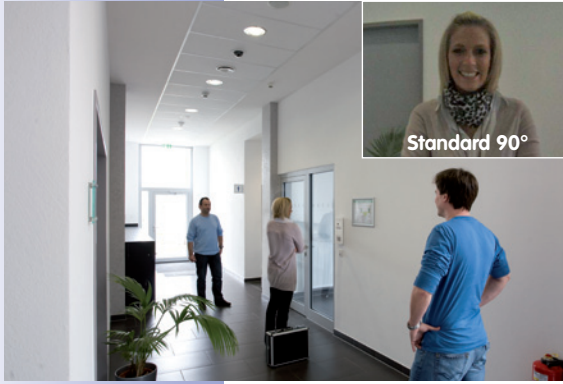

Seeing the entire scene with the T24

Hemispheric HiRes Camera

Thanks to the fisheye lens with its 180° image angle, the camera records the entire entrance area without having to be mechanically panned or tilted – **without any blind spots, from wall to wall, floor to ceiling**. It's impossible to "slip by" this camera. On the monitor located at the remote station, the operator can change the current image section in seconds: from a close-up of the visitor all the way to an overview panorama.

The hemispheric T24 door camera has a virtual, purely digital PTZ feature (pan/tilt/zoom). The image captured by the hemispheric camera can be zoomed smoothly, and you can simultaneously move to any section of the image in seconds, for example, using the mouse or the four large arrow keys on the Grandstream video telephone (left, right, up, down). This is similar to a mechanical PTZ camera, but without the maintenance and wear.

A Superior Overview Increases Security

The fisheye lens of the camera records the entire hemisphere of the scene without any blind spots and displays this image as the first part of the 360° full image. Here, there are technical limitations - predominantly at the edges of the image, where the geometric shape of the objects is heavily distorted, making them difficult to for the human eye to evaluate.



T24 360° Full Image



For this reason, the camera uses its integrated software to correct the images in the live view so that it can deliver user-friendly images at the remote video station. The operator can now **digitally tilt, pan and zoom** the image from the comfort of the remote station.

Original/MOBOTIX-T24-Image: 1280x480

180° Field Of View With No Blind Spots

Conventional door cameras have a standard 90° lens, meaning that they are only able to capture visitors standing directly in front of the lens. However, much of the time, the door station is not mounted in the immediate vicinity of the door, so the camera is at an angle to the visitor (see image). Even in this case, **thanks to its 180° image angle, the T24 delivers perfect images.**

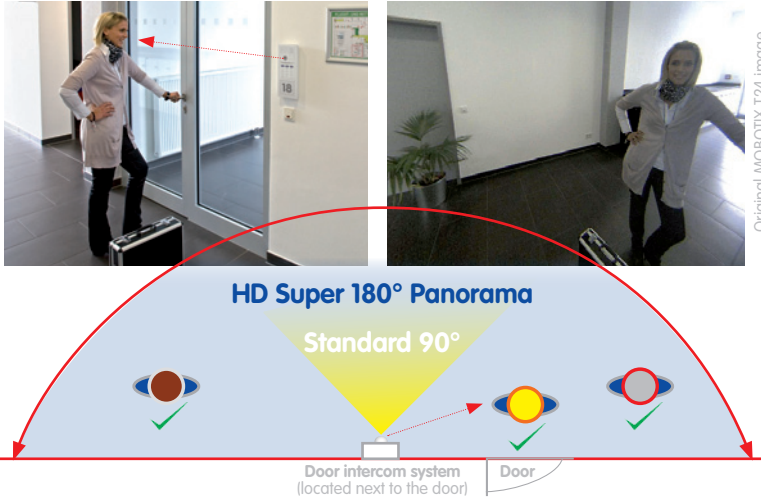

Original MOBOTIX T24 image

Right: Original
MOBOTIX T24 image

Direct Views Up And Down

And the hemispheric camera can do much, much more: it can record the area on the floor in front of the door, for example, even the often overlooked area underneath the door station. **And the T24 does all of this using only its software – without the need for moving parts or motors.** This camera is silent, discreet and unobtrusive.



Original MOBOTIX
T24 image (enlarged
image section)

Also, this quick look down is incredibly practical when checking, for example, whether the daily paper is already in front of the door. Of course, it is also possible to look upwards under the ceiling as well.

Product Overview: T24 Modules

In addition to the hemispheric HiRes camera, the latest MOBOTIX development also includes a multifunctional keypad module with transponder technology for keyless access and control of message functions (keypad).

A particular advantage of the T24 is the minimal amount of cabling involved – either a standard Ethernet cable (for example, CAT7) or existing bell wire is sufficient to connect the door station to the network in the building and to supply it with power. Only a PoE switch is necessary to connect remote stations (VoIP video phone or computer) and supply power. The PoE switch can be located in an electrical cabinet, for example.

Hemispheric camera

Allround view with no blind spots, with internal memory, speaker and microphone

Keypad

Keyless entry (RFID & PIN), voice mailbox operation

Info module

Optionally with integrated Mx2wire unit to connect the T24 via bell wire (data and power)



Door Camera With Allround View And No Blind Spots

With 3.1 megapixels and an internal memory, this hemispheric door camera records the entire entrance area. No blind spots from wall to wall and from floor to ceiling. The camera can record events automatically. For example, when someone rings the doorbell or if something moves in front of the door. The camera module with a remote station can be used as a compact basic video door station thanks to the integrated doorbell and light buttons. The camera saves high-resolution video with lip-synchronous sound directly to the integrated MicroSD flash card (up to 64 GB) without requiring an external storage device or computer and with no additional network load. The storage space is for up to 800,000 panorama images or 66 hours of video recordings.



Keypad With Contactless RFID Technology

This MOBOTIX-developed module can be used for several functions. Outdoors, it functions as the access control interface, either by entering a code on the keypad or by means of keyless access using a transponder (as a check card). The module can also be used by visitors and residents to record and play back messages. The keypad can be installed individually to secure adjacent rooms such as warehouses or VIP areas.



Info Module With/Without Mx2wire Technology

The info module features a backlit house number field and may also include an optional Mx2wire unit. This unit is needed if the outdoor station is to be connected to the PoE switch with an existing bell wire via a second Mx2wire indoor unit instead of directly using an Ethernet cable.



Security Door Opener With Backup Power Supply (Battery)

The door station may be coupled with a MOBOTIX security door opener with access code memory, making it impossible to open the door by forcibly removing the system and bypassing the connecting cable. A built-in rechargeable battery powers both the electrical door opener and the keypad in the outdoor station and guarantees that the door can be accessed using a transponder or PIN even in the case of power failure. For indoor installations, the security door opener also functions as a doorbell. The device features two status LEDs and two function buttons (doorbell, door opener).











T24 Components: Outdoors

The T24 camera module is also available with a particularly light-sensitive B/W sensor (MX-T24M-SecNight-N11)

One admin and several user RFID cards are included with the keypad

The Mx2wire indoor unit is always part of the Mx2wire info module

Terminal boards		
	Ethernet terminal board: Securely connects the camera module with the mounted 8 wires of the network patch cable via RJ45 connector. Only for T24 versions without Mx2wire.	MX-OPT-IO2
	IO module: The board provides an additional 8 signal inputs and 3 signal outputs to connect external devices (doorbell, light, etc.).	MX-OPT-IO1
Modules		
	Hemispheric camera: Fisheye lens (for 360° panorama view) and integrated live image correction, high-resolution 3.1 megapixel color sensor, speaker, microphone and 4 GB data storage for approx. 250 one-minute video clips or 60,000 VGA images.	MX-T24M-Sec-D11
	Keypad: Keyless and scheduled access. This requires the user to enter a code, or it can open the door in response to an RFID transponder card. The voice mailbox can also be operated via the keypad.	MX-Keypad1-EXT
	Info module: Provides the option to display the house number and/or name to the door station. The module is equipped with permanent backlighting using energy-saving and long-lasting LED technology.	MX-Info1-EXT
	Mx2wire info module: The info module with Mx2wire technology and a second Mx2wire unit for mounting inside the building offers users not only the standard info module functions but also the option to connect and supply power to the door station via existing two-wire cabling instead of a network cable.	MX-2wire-Info1-EXT
Frame		
	Single frame: 131 x 143 x 18 mm (W x H x D). Integrated electromagnetic anti-theft protection. Includes special key for module unlocking, housing seal and installation material.	MX-OPT-Frame-1-EXT
	Double frame: 131 x 233 x 18 mm (W x H x D). Integrated electromagnetic anti-theft protection. Includes special key for module unlocking, housing seal and installation material.	MX-OPT-Frame-2-EXT
	Triple frame: 131 x 333 x 18 mm (W x H x D). Integrated electromagnetic anti-theft protection. Includes special key for module unlocking, housing seal and installation material.	MX-OPT-Frame-3-EXT

On-wall housing		
	Single on-wall housing: 126 x 138 x 31 mm (W x H x D). Metal-reinforced housing.	MX-OPT-Box-1-EXT-ON
	Double on-wall housing: 126 x 227 x 31 mm (W x H x D). Metal-reinforced housing.	MX-OPT-Box-2-EXT-ON
	Triple on-wall housing: 126 x 327 x 31 mm (W x H x D). Metal-reinforced housing.	MX-OPT-Box-3-EXT-ON
In-wall housing (incl. plasterwork protection)		
	Single in-wall housing: 123 x 138 x 52 mm (W x H x D). The in-wall housing is securely connected with the subsurface or brick work. It can also be used to ensure easy installation in cavities.	MX-OPT-Box-1-EXT-IN
	Double in-wall housing: 123 x 228 x 52 mm (W x H x D). The in-wall housing is securely connected with the subsurface or brick work. It can also be used to ensure easy installation in cavities.	MX-OPT-Box-2-EXT-IN
	Triple in-wall housing: 123 x 328 x 52 mm (W x H x D). The in-wall housing is securely connected with the subsurface or brick work. It can also be used to ensure easy installation in cavities.	MX-OPT-Box-3-EXT-IN

The required flush-mounting opening has the following dimensions (width x height):

Single housing:
117 x 129 mm

Double housing:
117 x 218 mm

Triple housing:
117 x 318 mm

T24 Components: Indoors

The Mx2wire indoor unit is always part of the Mx2wire info module

Free download at www.mobotix.com

Security Door Opener With Backup Power Supply		
	The T24 may be coupled with the MOBOTIX security door opener with internal access code memory and battery for back-up power supply, making it impossible to open the door by forcibly removing the system and bypassing the connecting cable.	MX-Door-INT
Mx2wire Indoor Unit		
	An Mx2wire set always consists of two devices that communicate with one another. For this reason, the Mx2wire info module in the door station also requires a corresponding unit to connect to the network and to supply power.	MX-2wire-Info-EXT
Remote Stations		
	IP video telephone: MOBOTIX recommends the GXV3140 from Grandstream as a remote video station for the T24 door station. This modern IP video telephone is based on the world standard in telephony - VoIP/SIP with H.264 - and provides a large color LCD display with excellent image quality.	Grandstream GXV3140
	MxEasy video management software: MOBOTIX provides the MxEasy software (for Windows, Mac and Linux) free of charge to configure and operate the T24 IP Video Door Station with a network-enabled desktop or notebook computer.	Free of charge
Accessories		
	NPA-PoE-Set: The MOBOTIX Network Power Adapter Set (NPA-PoE set) is a high-quality, robust, ultra-compact, and - above all - multifunctional PoE injector with three connectors (network, camera/PoE device, PC) and a universal power supply unit with adapter plugs. The Network Power Adapter Set remotely supplies the T24 door station and all other PoE devices with power in accordance with the IEEE 802.3af standard. It is therefore possible to secure the power supply for distances up to 100 m (300 ft) using the network cable. As a result, the T24 IP Video Door Station can be supplied with PoE power via the adapter and connected directly to a Grandstream video telephone or to a computer (integrated crossover function).	MX-NPA-PoE set

T24: The Custom-Made IP Video Door Station

The T24 product line is a modular system that can be adapted to any customer needs. This highly robust and weatherproof outdoor station (IP65, suitable for -30°C to +50°C / -22°F to +122°F) is available in four attractive colors: white, silver, dark gray, black and amber.



white (PW)

silver (SV)

dark gray (DG)

black (BL)

amber (AM)

Only white and silver-colored IP Video Door Stations should be exposed to direct sunlight (risk of overheating on dark surfaces)

The color abbreviation is added at the end of the order number in each case (for example, white camera module: MX-T24M-Sec-D11-PW)

You will find the T24 online configurator tool on the MOBOTIX website, which you can use to plan your individual T24 door station.

You can choose the individual components step-by-step so that no individual component is forgotten. Accessories required for your selected components are automatically added by the configuration tool.

After you have finished the configuration, the system creates a preview image of the system as well as a parts list, which you can hand to your electronics specialist for an installation quote.

The web configurator can be found on the MOBOTIX website under the main menu item **Products > T24 configurator**.

T24: A Future-Oriented System

With the T24, MOBOTIX offers a new product range for the home automation market and it will be extended and complemented with other new products.

For example, a **suitable bell module** with up to four keys and integrated RFID technology will soon be available. And the best part for all MOBOTIX customers: all future T24 innovations are also compatible with T24 systems that have already been purchased.



www.mobotix.com >
Products > T24
Configurator

Various configuration examples in all available MOBOTIX colors

Only white and silver-colored IP Video Door Stations should be exposed to direct sunlight (risk of overheating on dark surfaces)



Camera in single frame (PW)



Camera in single frame (SV)



Camera in single frame (DG)



Camera in single frame (BL)



Camera in single frame (AM)



Camera and keypad in double frame (PW)



Camera and keypad in double frame (SV)



Camera and keypad in double frame (DG)



Camera and keypad in double frame (BL)



Camera and keypad in double frame (AM)



Camera and info module in double frame (PW)



Camera and info module in double frame (SV)



Camera and info module in double frame (DG)



Camera and info module in double frame (BL)



Camera and info module in double frame (AM)



Camera, keypad and info module in triple frame (PW)



Camera, keypad and info module in triple frame (SV)



Camera, keypad and info module in triple frame (DG)



Camera, keypad and info module in triple frame (BL)



Camera, keypad and info module in triple frame (AM)



SYSTEM OVERVIEW: T24 IP VIDEO DOOR STATION

What does a typical system look like and what components are included? This section describes the setup for a complete system with a video door station including a security door opener, keypad and info module with Mx2wire technology to connect the door station using existing two-wire cabling. In newer buildings, it is preferable to lay an Ethernet cable directly to the door.

Hemispheric camera (with LEDs)

- Two-way video communication
- Lip-synchronous sound
- Event-controlled recording
- Outdoor light and doorbell button

Keypad (integrated)

- Open/lock door
- Keyless access (RFID and PIN)
- Operate voice mailbox

Info module (backlit)

- With Mx2wire technology (optional)
(Data transfer and power supply via two-wire connection)



MxBus two-wire cabling:

- Data (9,600 baud) and power (PoE)
- Max. 8 devices to be connected
- Encrypted data transfer
- Power supply and control via camera



Standard PC (remote station)

- Free MOBOTIX MxEasy software
- T24 configuration and operation
- All functions including two-way video communication
- Connection via Ethernet/WLAN

Global access over any Internet connection

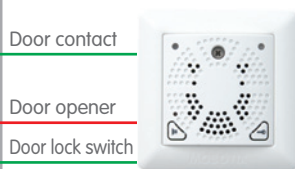

Security Door Opener

- Open door, doorbell on/off
- Status LEDs for door and messages
- Backup power supply with battery
- Connection of door opener and sensors



Mx2wire Indoor Unit

- Remote station for unit in the info module
- Data transfer and power supply via two-wire connection
- Alternative to standard Ethernet cable
- Power input with PoE+ switch or 48-57 V DC, 600 mA power supply unit

Network connection

Connection to switch, router

PoE switch/PoE+ with Mx2wire

Network connection

Connection to switch, router



Internet connection

Worldwide access



VoIP video phone (ground floor remote station)

- Two-way video communication, open door, turn light on/off
- Operate camera (including image correction)
- Monitor door status (open/closed/locked)
- Recording and event search
- Voice mailbox player



1 SYSTEM OVERVIEW

1.1 Outdoor Station

1.1.1 Hemispheric Camera

The hemispheric T24 camera with its fisheye lens (for a 360° panorama view) and integrated live image correction boasts a high-resolution 3.1 megapixel color sensor (or megapixel black and white sensor), speaker, microphone and 4 GB data storage for approx. 250 one-minute video clips or 60,000 VGA images.

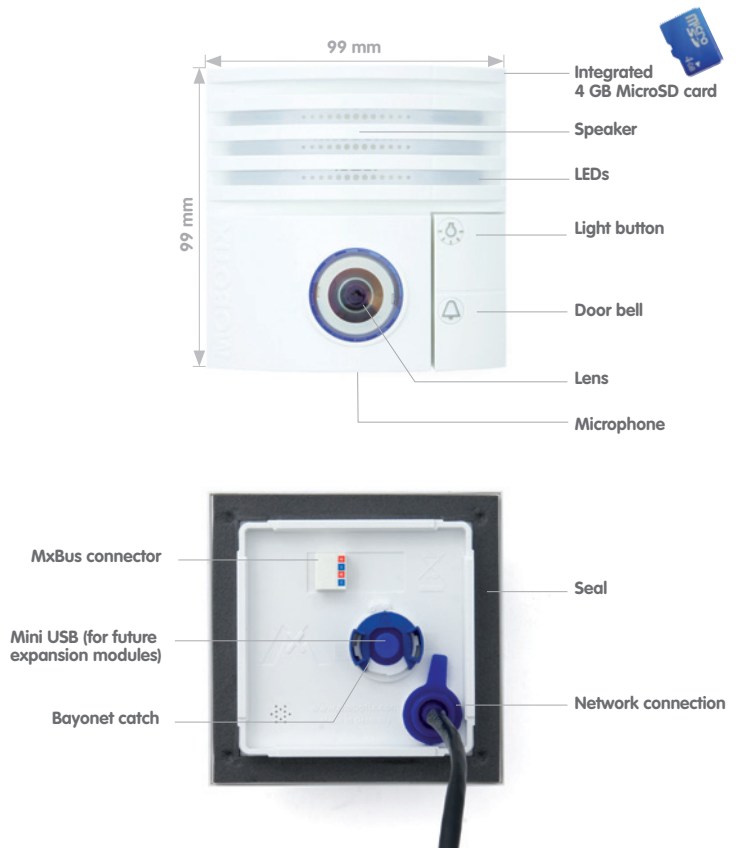

Technical Specifications: T24 Hemispheric Camera	
Model versions	Secure, Secure-Night (T24M-Sec-Night-N11)
Lens options	L11 Hemispheric 360°
Sensitivity	Color version: 1 lux (t = 1/60 s), 0.05 lux (t = 1/1 s) B/W version: 0.1 lux (t = 1/60 s), 0.005 lux (t = 1/1 s)
Image sensor	1/2" CMOS, progressive scan
Max. image resolution	Color: 2,048 x 1,536 (3MEGA) B/W: 1,280 x 960 (MEGA)
Image formats	Selectable image formats (160 x 120 to 2,048 x 1,536/color); PTZ view, Quad view, Panorama widescreen image, Double Panorama, Panorama Focus with 3 views
Max. frame rate (M-JPEG) (live/recording)	VGA: 25 fps, TV-PAL: 18 fps, MEGA: 8 fps, 3MEGA: 4 fps
Max. video stream (MxPEG) (live/recording/audio)	VGA: 30 fps, TV-PAL: 30 fps, MEGA: 30 fps, 3MEGA: 20 fps
Image compression	MxPEG, M-JPEG, JPEG, H.263 and H.264 (only with Video VoIP)
Internal DVR	4 GB MicroSD card (camera-internal recording, max. 32 GB usable)
External video storage	Directly on NAS and PC/Server without additional recording software
Software (included)	MxEasy video management software
Image processing	Backlight compensation, automatic white balance, image correction (incl. panorama image correction), video sensor (motion detection)
Virtual PTZ	Digital pan/tilt/zoom, continuous 8x zoom
Alarm/events	Triggering of events through integrated multiple-window motion detection, temperature sensor, notification over email, FTP, IP telephony (VoIP, SIP), visual/acoustic alarm, pre- and post-alarm images
Audio	Microphone, speaker, G.711, lip-synchronous sound
Video telephony	VoIP/SIP, two-way video communication, remote controlling with key code, event notification
Security	User/group management, HTTPS/SSL, IP address filter, IEEE 802.1x, intrusion detection, digital image signature
Certificates	EMV (EN50121-4, EN55022, EN55024, EN61000-6-2, FCC part15B, AS/NZS3548)
Power supply	Power over Ethernet (PoE in accordance with IEEE802.3af): PoE class variable depending on operating mode; power consumption: typically 3 W; via PoE switch/MOBOTIX PoE adapter/Mx2wire
Operating conditions	IP65 (DIN EN 60529), -30°C to + 50°C (-22°F to +122°F)
Interfaces	MxBus, USB, Ethernet
Dimensions (W x H)	99 mm x 99 mm

The camera is also available in a version with a black and white sensor (extremely light-sensitive sensor)

1.1.2 Ethernet Terminal Board

The Ethernet terminal board is used to connect the door station for the T24 versions **without Mx2wire technology**. It securely connects the camera module with the 8 connected wires of the network patch cable via RJ45 connector (for installation, see Chapter 2).

MX-OPT-IO2



Caution

Only use **original MOBOTIX cables** to connect the camera.

Standard cables purchased from other suppliers do not meet the necessary specifications for proper fastening (not impermeable/weatherproof).



Ethernet patch cable

The Ethernet terminal board is screwed on to the housing (on-wall or in-wall) behind the camera module.



Alternatively, the extended terminal board can be used to connect external devices, such as a doorbell (MX-OPT-IO1)

Included in delivery:
An Admin RFID card
for the operation
and activation
of user cards



Included in delivery:
Several User RFID
cards for door opening
and voice mailbox access



Additional cards
(Admin/User) can
be ordered from
MOBOTIX

1.1.3 Keypad

This module is used for keyless and scheduled access to the house or building with an access PIN or RFID transponder card.

Voice messages can also be spoken and played back using the keypad.

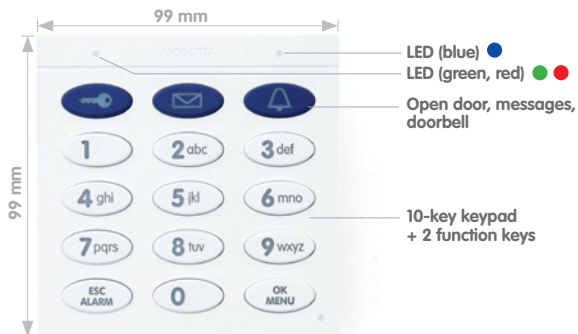

View with housing cover removed



Technical Specifications: Keypad	
Functions	Keyless access using RFID card and PIN
Interface	MxBus
User interfaces	RFID (13.56 MHz, Mifare DESFire EV1), illuminated keys, acoustic feedback
Inputs	2 galvanically separated inputs (AC/DC, self-powered, up to 50 V)
Outputs	1 isolated relay output (AC/DC, -50 V/60 W/2 A)
Sensors	Illumination sensor
Protection class	IP65 (DIN EN 60529)
Operating temperature	-30°C to +50°C / -22°F to +122°F (DIN EN 50125)
Power supply	MxBus
Power consumption	typically 1 W
Dimensions (W x H)	99 mm x 99 mm

In the case of a power failure, the keypad and the door opener are supplied with power from the battery of the security door opener

Technical Specifications: Terminals Used On The Keypad	
Cable cross-section, fixed	min. 0.14 mm ² /max. 0.5 mm ²
Cable cross-section, flexible	min. 0.2 mm ² /max. 0.5 mm ²
Cable cross-section, flexible, with wire-end sleeves without plastic sleeves	min. 0.25 mm ² /max. 0.5 mm ²
Cable cross-section AWG/kcmil	min. 24/max. 20
AWG according to UL/CUL	min. 26/max. 20

Recommended wire diameter: 0.6 to 0.8 mm

1.1.4 Info Module

The standard info module provides the option to attach the house or building number and/or name to the door station. The module is equipped with permanent backlighting using energy-saving and long-lasting LED technology.

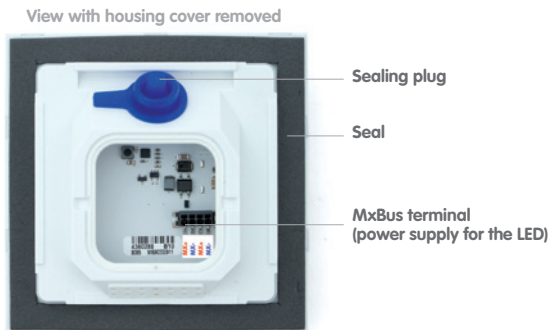

Technical Specifications: Info Module	
Functions	Information for visitors on nameplate (name, street number, etc.)
Interfaces	MxBus
User interfaces	Backlit, printable foil (UV-protected)
Protection class	IP65 (DIN EN 60529)
Operating temperature	-30°C to +50°C / -22°F to +122°F (DIN EN 50125)
Power supply	MxBus
Power consumption	typically 0.2 W
Dimensions (W x H)	99 mm x 99 mm

Technical Specifications: Terminals Used On The Info Module	
Cable cross-section, fixed	min. 0.14 mm ² /max. 0.5 mm ²
Cable cross-section, flexible	min. 0.2 mm ² /max. 0.5 mm ²
Cable cross-section, flexible, with wire-end sleeves without plastic sleeves	min. 0.25 mm ² /max. 0.5 mm ²
Cable cross-section AWG/kmil	min. 24/max. 20
AWG according to UL/CUL	min. 26/max. 20

Recommended wire diameter: 0.6 to 0.8 mm

Note On Labeling Info Module

You will find some PDF templates, which you can print out yourself, on the MOBOTIX website (www.mobotix.com).

1.1.5 Mx2wire Info Module With Indoor Unit (Set)

Mx2wire Info Module

The info module with Mx2wire technology, combined with a second Mx2wire unit to be mounted inside the building, offers users not only the standard info module functions but also the option to connect and supply power to the door station via two-wire cabling instead of a network cable (see Section 1.1.4). Advantage: Simple and cost-effective installation thanks to reuse of already existing two-wire cabling.

The two status LEDs (orange, green) are activated for test purposes within the first 15 minutes after the info module has been powered up

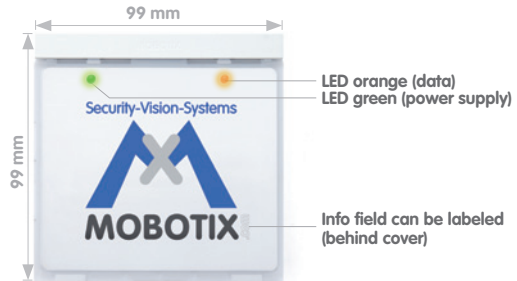

View with housing cover removed

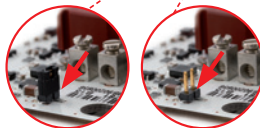
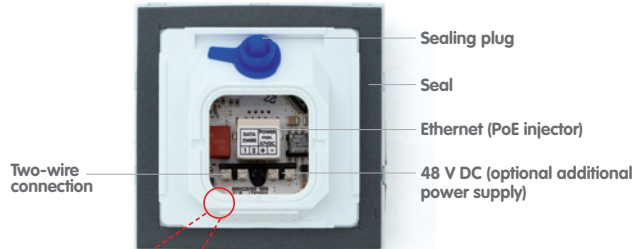

LED illumination deactivated

LED illumination activated

To activate the LED illumination of the Info Module Mx2wire, you need to cautiously remove the small black jumper on the circuit board (using tweezers or small pliers) before mounting the module itself.

A PoE+ switch or an external voltage connection (48-57 V DC, 600 mA) can be used

Technical Specifications: Mx2wire Info Module	
Data transfer rate	Up to 50 Mbps net (depending on distance)
Interfaces	Ethernet (PoE injector), Mx2wire indoor unit, 48-57 V DC, 600 mA (optional additional supply)
Certificates	EMV (EN55022, EN55024, EN61000-6-1, FCC part15B, AS/NZS3548)
Protection class	IP65 (DIN EN 60529)
Operating temperature	-30°C to +50°C / -22°F to +122°F (DIN EN 50125)
Connecting wire thickness	Cable cross-section 0.14 to 2.5 mm ² , diameter 0.4 to 1.6 mm
Dimensions (W x H)	99 mm x 99 mm

Note On Labeling Mx2wire Info Module

You will find some PDF templates, which you can print out yourself, on the MOBOTIX website (www.mobotix.com).

Standard Two-Wire Cabling (Already Laid In Buildings)

Analog Telephone Line Or Bell Wire

- Cable type: JY, A2Y and YR (telephone and low-voltage cable)
- Very good availability in buildings
- Core diameter 0.6 to 0.8 mm
- Range (at 50 Mbps): 100 m (0.6 mm), 200 m (0.8 mm)



Power Line (Should No Longer Be Live)

- Cable type: NY (installation cable)
- Widespread availability of cables
- Cables must be disconnected from the power supply!
- Wire cross-section max. 1.5 mm²
- Range (at 40 Mbps): 300 m

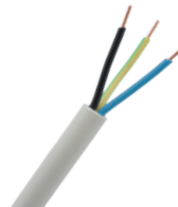

Safety Warning

Use this product in compliance with the applicable legal regulations. Electrical systems and equipment may only be set up, changed and maintained by a qualified electrician or under the management and supervision of a qualified electrician in accordance with electrotechnical regulations.



Mx2wire Indoor Unit

An Mx2wire set always consists of two devices that communicate with one another. For this reason, the necessary unit to connect to the network and to supply power is included with the Mx2wire info module in the door station.



Power supply with PoE+ switch or 48-57 V DC, 600 mA (power supply unit)





48-57 V DC (optional additional power supply)

Two-wire connection (Mx2wire info module)



Technical Specifications: Mx2wire Indoor	
Data transfer rate	Up to 50 Mbps net (depending on distance)
Interfaces	Ethernet (PoE Class 3), Mx2wire info module, 48-57 V DC, 600 mA (optional additional supply)
Certificates	EMV (EN55022, EN55024, EN61000-6-1, FCC part15B, AS/NZS3548)
Power supply	PoE+ (PoE IEEE802.3af), performance-related 7 Watt own consumption or 48-57 V DC, 600 mA SELV power supply unit
Status display	LED green (network connection, power supply), LED orange (data transfer via AB conductor is active, door station connected)
Operating conditions	-30°C to +50°C / -22°F to +122°F
Connecting wire thickness	Cable cross-section 0.14 to 2.5 mm ² , diameter 0.4 to 1.6 mm
Dimensions (W x H x D)	80 mm x 80 mm x 38 mm (in-wall version), 80 mm x 80 mm x 45 mm (on-wall version)

Max. Cable Lengths Of Usable Cable Types As Two-Wire Cable Of A T24 Door Station

Cable type	Cable thickness	Max. cable length
Antenna or coaxial cable 	0.6 mm (inner core)	100 m (50 Mbps)
Telephone line/ bell wire 	0.6 mm	100 m (50 Mbps)
	0.8 mm	200 m (50 Mbps)
Installation cable 	1.5 mm ²	300 m (40 Mbps)
Network installation cable 	Cat7	500 m (45 Mbps)

Notes

The **Mx2wire set consisting of two units (info module and indoor unit)** contains all the components required to establish an Ethernet connection via a two-wire cable.

Please note that the two Mx2wire units are matching pairs and preconfigured at the factory. The use of a different Mx2wire unit that was not supplied in the original packaging is therefore technically not possible. In case of a defect, both units must always be exchanged for a new Mx2wire pair that has been configured by MOBOTIX.

- Mx2wire pair for T24:
- Mx2wire info module
 - Mx2wire indoor unit

1.1.6 Housing And Module Frames

The robust IP Video Door Station can be installed in both on-wall and in-wall systems, it is weatherproof (IP 65) and cannot be stolen. The system consists of a housing and a frame. The frame for mounting the modules is simply screwed on to the housing used.

On-Wall Housing (Fig. Triple Housing)

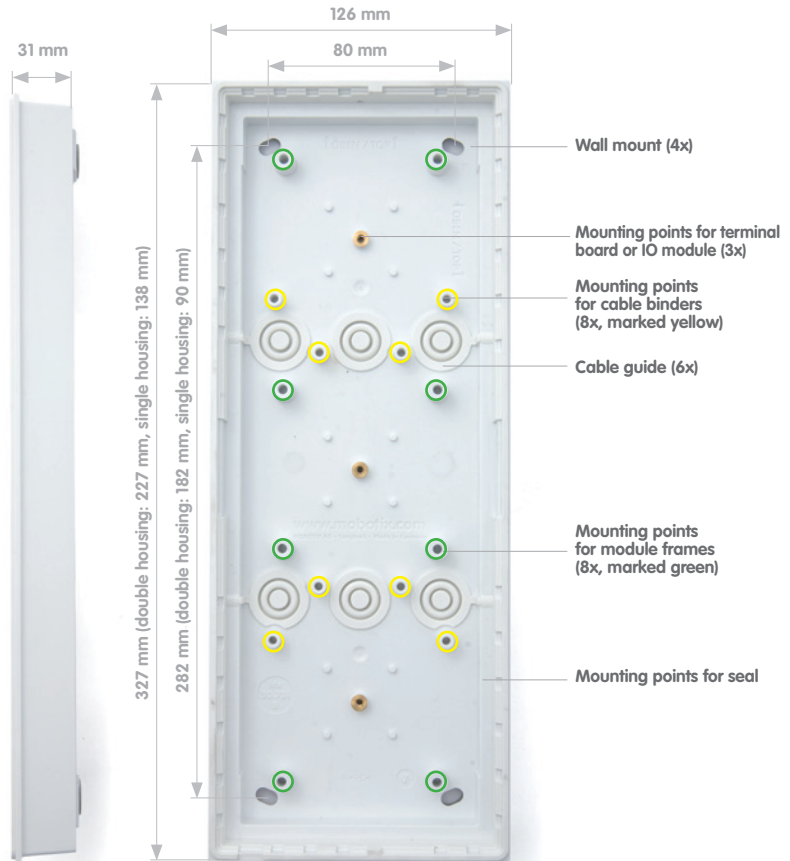



In-Wall And Cavity Housing (Fig. Triple Housing)

The blue housing is firmly connected to the subsurface or brick work. It can **also be used to ensure easy installation in cavities**: Drill opening, position housing and screw tightly in place; the retaining wings, which automatically swing out, secure the housing, while the plastic bars at the edge of the housing prevent it from sliding into the cavity.

The insert prevents the in-wall housing from getting dirty or being deformed during installation

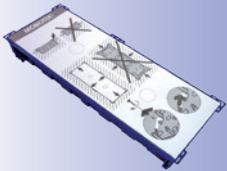

The required integration opening has the following dimensions (width x height):

Single housing:
117 x 129 mm

Double housing:
117 x 218 mm

Triple housing:
117 x 318 mm

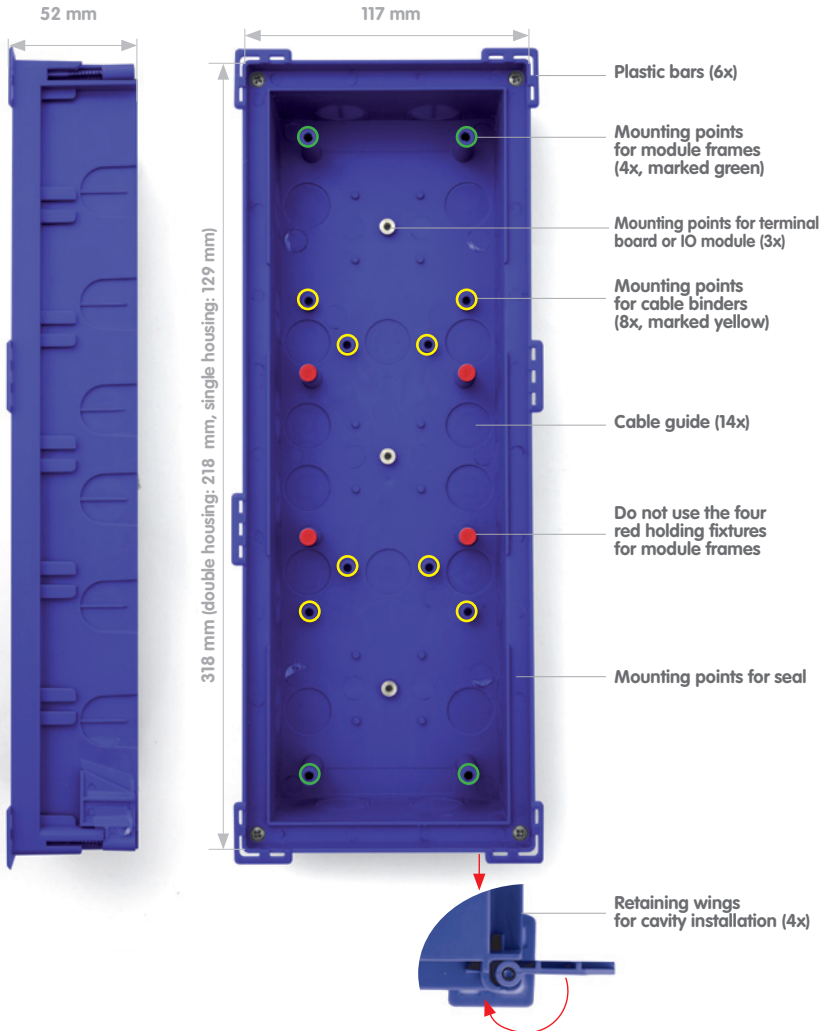

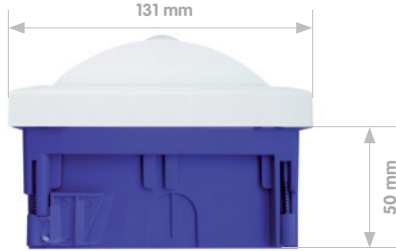

Permissible wall thickness
for cavity installation:
min. 7 mm/max. 27 mm



Module Frame (Fig. Triple Frame)

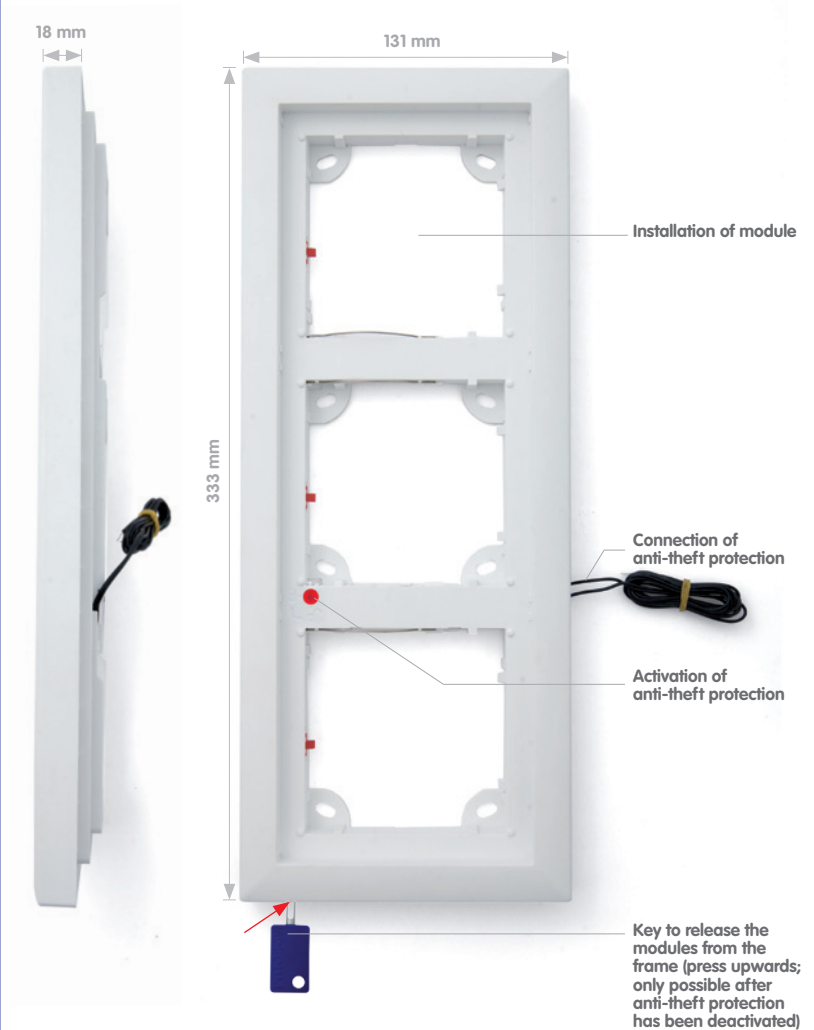

Modules
Camera, keypad,
info module/Mx2wire
info module

Frame
With integrated
anti-theft
protection

Terminal board*
Ethernet terminal
board or
IO module

Housing
On-wall or
in-wall
housing



* Ethernet terminal board (MX-OPT-IO2) is not required when using Mx2wire technology

1.2 Security Door Opener

The T24 may be coupled with the MOBOTIX security door opener with internal access code memory, making it impossible to open the door by forcibly removing the system and bypassing the connecting cable.

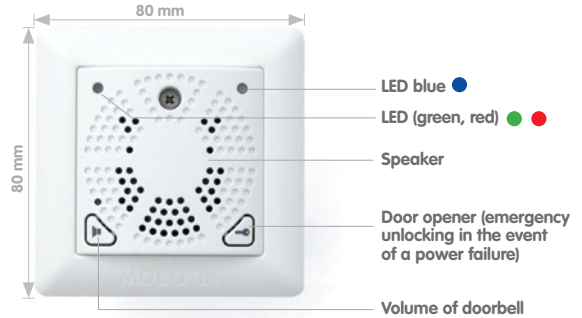

Minimum mounting dimensions:

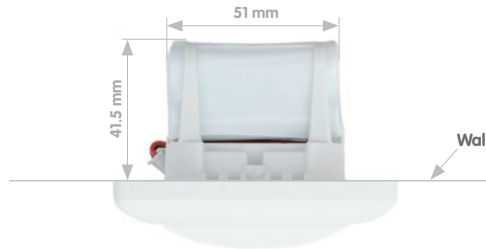
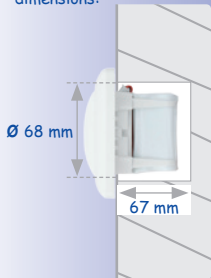

Technical Specifications: Security Door Opener	
Functions	Security door opener with internal access code memory
Interfaces	MxBus (max. 50 m distance to door station)
User interfaces	2 status LEDs, 2 function buttons, integrated speaker (doorbell)
Inputs	2 galvanically separated inputs with shared ground connection (AC/DC, self-powered – 50 V)
Outputs	1 isolated relay output (AC/DC, 24 V/1 A) or 1 connector for standard door opener (6-12 V AC) 1 output for MOBOTIX anti-theft protection (12 V DC)
Protection class	IP 20 (DIN EN 60529)
Operating temperature	-5°C to +40°C / +23°F to +104°F (DIN EN 50125)
Power supply	MxBus
Power consumption	typically 1 W
Output	max. 10 W
Switch time	max. 5 s
Connecting wire thickness	Cable cross-section 0.14 to 2.5 mm ² , diameter 0.4 to 1.6 mm
Dimensions (W x H x D)	80 mm x 80 mm x 41.5 mm

Max. cable length for MxBus is 50 m

Note

The **battery pack** supplies the electrical door opener and, in the event of a power failure, the keypad, which continues to guarantee that the door can be unlocked multiple times. For installations in living areas, the security door opener functions also as a doorbell.

Thanks to the battery, the door opener continues to function in the event of a power failure

Supported Door Versions

An electrically-operated standard door opener (6 to 12 V AC, min. nominal resistance 10 ohm, no support for closed-circuit current function) can be connected directly to the security door opener and powered by its integrated battery pack. It is not necessary to connect an additional power supply unit.

By integrating an additional power supply unit, door openers with up 24 V AC/DC (max. 1 A) or a self-locking door lock (e.g., Mediator) can be connected.

1.3 Remote Stations

1.3.1 Grandstream IP Video Telephone GXV3140

MOBOTIX recommends the GXV3140 from Grandstream as a remote video station for the T24 door station. This modern IP video telephone is based on the world standard in telephony, VoIP/SIP with H.264, and provides a large color LCD display with excellent image quality. The device is conveniently operated via a MOBOTIX user menu.



Basic T24 functions can also be controlled using the phone keys



Extensive Multimedia Facilities

The GXV3140 from Grandstream includes important features such as transfer, hold and conference calling for use in a professional environment, in addition to numerous multimedia functions. The full duplex speaker phone is equipped with an acoustic echo canceller for noise suppression.

The integrated camera can be switched on or off at the touch of a button. Additional multimedia features include: a multimedia player for data from a USB stick or SD card, display of RSS feeds and access to Internet radio.

The device also includes two Fast Ethernet connectors, a USB port (for external keyboards etc.) and an SD card slot, so you can easily transfer and use your own data with the phone. The integrated 2.5 mm connector allows you to attach a headset, and the video images can be displayed on an external monitor using the A/V jack.

Note

In principle, other IP video telephones (with H.264 and G.711) can also be used as a T24 remote station. Due to the technical specifications of a particular device (display size, audio functions, etc.), however, it cannot be guaranteed that all T24 remote station functions of the Grandstream GXV3140 are available.

See also:
www.grandstream.com

1.3.2 MxEasy Video Management Software

MOBOTIX provides the MxEasy software free of charge to configure and operate the T24 IP Video Door Station with a network-enabled desktop or notebook computer. In principle, there is no need for a computer to handle configuration or operation when there is a simple application scenario (one door station only, IP video telephone as remote station).

MxEasy (free download
from www.mobotix.com)

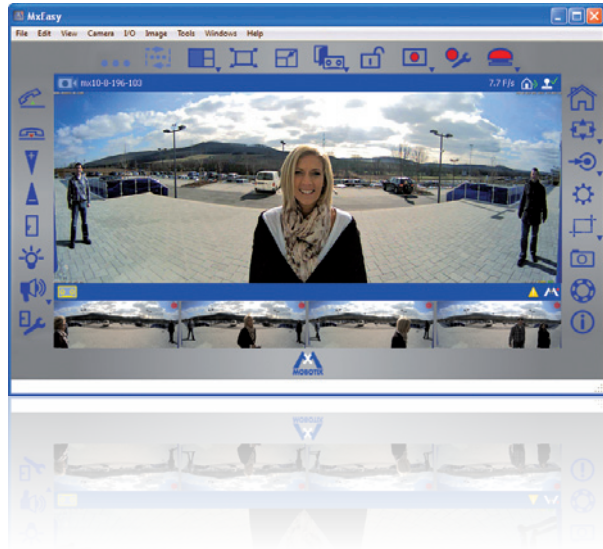

MxEasy allows you to quickly and efficiently implement and control a video security system of 1 to 16 MOBOTIX cameras, making it the perfect choice for all small and mid-sized surveillance systems and the T24 IP Video Door Station. The program automatically detects all installed cameras/door stations - even in non-administered networks - and carries out the initial configuration. You are not required to have an in-depth knowledge of network technology.

MxEasy enables the user to conveniently control the most important functions of the connected door station. Virtual zooming, panning and tilting in the live image is just as easy as using the live two-way video communication with the visitor, opening the door or activating recording. The video data recorded by the cameras can then be viewed and exported in different formats, such as H.264, at a later time.

Easy Operation

MxEasy is easy to understand and simple to use. Descriptions for each graphical button ("tooltips") are displayed automatically. The user interface was also optimized for use with mobile devices and touch panels. Incorrect settings can be easily reversed using the automatic backup feature.

Security

MxEasy provides you with four different access levels (Guest, User, Owner, Administrator), allowing people with different levels of authorization to access the camera images. MxEasy can be installed on several computers at the same time. Optional HTTPS encryption (using certificates generated by the camera or created by the administrator) helps you to prevent unauthorized users from accessing MxEasy.

1.4 Accessories

1.4.1 NPA-PoE Set

The MOBOTIX Network Power Adapter Set (NPA-PoE set) is a high-quality, robust, ultra-compact, and - above all - multifunctional PoE injector with three connectors (network, camera/PoE device, PC) and a universal power supply unit with adapter plugs. The Network Power Adapter Set supplies the T24 door station and all other PoE devices with power in accordance with the IEEE 802.3af standard. It is therefore possible to secure the power supply for distances up to 100 m (300 ft) using the network cable. As a result, the T24 IP Video Door Station can be supplied with PoE power via the adapter and connected directly to a remote station (integrated crossover function).

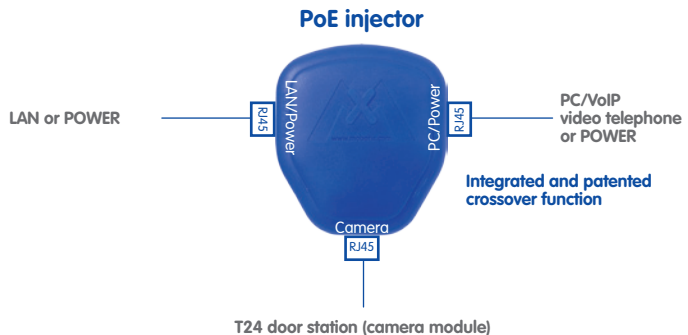

This device is especially practical because the supplied **power supply unit** can be used around the world by changing the adapters as required in just two simple steps. The "E.U." version of the NPA-PoE Set is supplied as standard with a European adapter, while the "INT" version includes four adapters (EU, USA, UK, AUS). Another product benefit is the option to connect to power sources from 12 V to 42 V that are independent of the network, which is ideal for solar and battery operation of the door station (e.g., in a holiday home).

MX-NPA-PoE-Set-EN
and MX-NPA-PoE-Set-
INT incl. adapter for
EU, US, UK and AUS



1.4.2 IO Module (Extended Terminal Boards)

In addition to the Ethernet terminal board (MX-OPT-IO2), MOBOTIX offers an IO module (MX-OPT-IO1) with extended connection options for the door station (e.g., doorbell buttons, light, garage door opener, etc.).

The board provides 8 switch inputs and 3 switch outputs. The network cable and the T24 camera module are connected in the same manner as the Ethernet terminal board.



MX-OPT-IO1

Note

Please read further information on the connection details and on using this product in Section 2.7.1.

1.4.3 Additional Devices For PoE Power Supply

By default, power is supplied to the T24 IP Video Door Station via the network cable that is connected to the Ethernet terminal board behind the camera module. **PoE injectors or switches with integrated PoE power supply according to IEEE 802.3af** can be used to supply power to the network.



Info Module Mx2wire
With Indoor Unit
(MX-2wire-Info1-EXT)



PoE+ According To IEEE 802.3at For Mx2wire

If the T24 version with Mx2wire technology is installed, data and power are supplied to the door station via a two-wire cable, which is connected to the network via an Mx2wire indoor unit. Due to the increased energy requirements of the Mx2wire technology, PoE supply according to IEEE 802.3af is not sufficient. **A PoE injector/switch (performance class PoE+ according to IEEE 802.3at) has to be used instead, or an external voltage source (48 V DC) must be connected to one of the two Mx2wire units** (info module or indoor unit).

Switch Or PoE Injector?

A switch connects individual network-enabled devices to one another and delivers data. In the case of a home network, this function is normally performed by an existing router with multiple network ports, which is also capable of connecting to the Internet (such as the Fritz!Box). In this case and if only one T24 door station needs to be supplied with power, it is sufficient to purchase one PoE injector.

When purchasing a switch with an additional PoE power supply, make sure that a sufficient number of ports are supported (this is especially important if other PoE-supplied devices apart from the T24 are connected to the switch).

Furthermore, it is crucial that the switch fulfils all the requirements for using the PoE-supplied door station outdoors (electromagnetic compatibility, lightning and surge protection through galvanically-separated ports).

1.4.4 Additional Video Remote Stations

Thanks to the use of network technology, the T24 is not bound to just one expensive, manufacturer-dependent remote station. It can be connected to any suitable VoIP video phone (video: H.264, sound: G.711) in the world. In addition to supporting the two-way video communication feature with video and sound, these devices support additional features such as door/light control, image search, quick recording and PTZ functions. So called SIP softphones are also suitable as remote video stations.

1.4.5 Door Sensors

Connection options are also provided on the door station for conventional door and door lock switches (open/close door, open/close lock).

1.4.6 Electrical Door Opener

The T24 Door Station should always be connected to an electrical door locking system, which can be activated via the MOBOTIX security door opener in a tamper-proof manner.

Product Information: Self-Locking Door Lock

Traditional door openers only electromechanically release a locking tab on the door. In order to open an additional, key-locked door without using the key and as described above, **a door lock that can be locked/unlocked electrically is required instead of a traditional door opener (e.g., Mediator, www.assaabloy.de).**

This also applies when the door in question has to be locked at all times for insurance reasons and the keyless door opening function of the T24 is to be used as well (transponder/PIN).

2 INSTALLATION

2.1 Overview: Connection And Wiring Diagrams

The following diagrams are an overview of the wiring plans that will allow you to connect the T24 IP Video Door Station as intended. Please refer closely to the configuration that best suits your particular needs.

2.1.1 T24 With A Security Door Opener

Using a **MOBOTIX security door opener with decentralized access code memory makes it impossible to open the door by bypassing the connection cable, thereby protecting your system against unauthorized access.** A battery, kept fully charged via MxBus at all times, supplies power to the electric door opening mechanism - even in the case of a power failure.

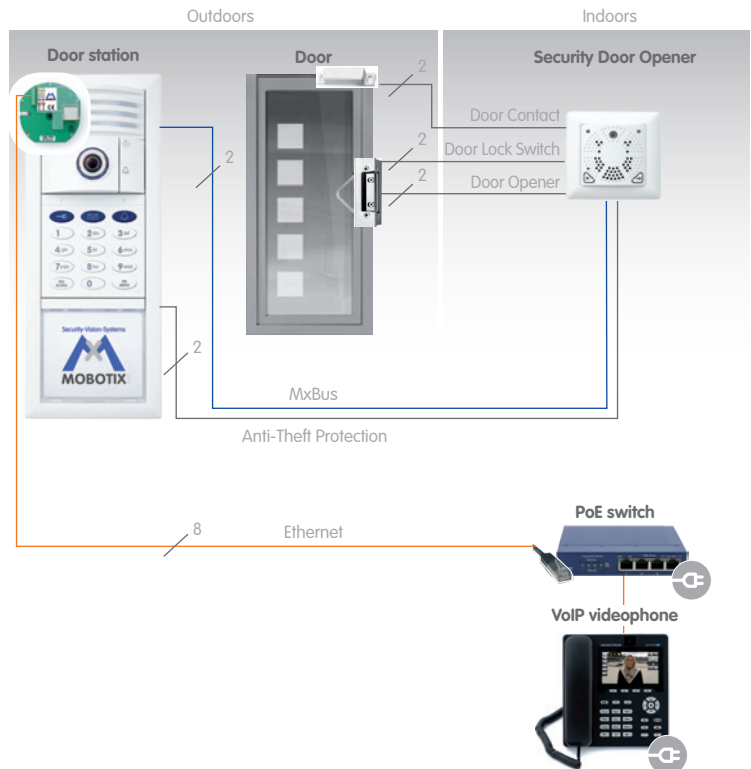

The figure above the connection sections represents the number of cable wires

Black: YSTY 0.8 (recommended) or 0.6 mm

Orange: Ethernet Cat. 5 or higher

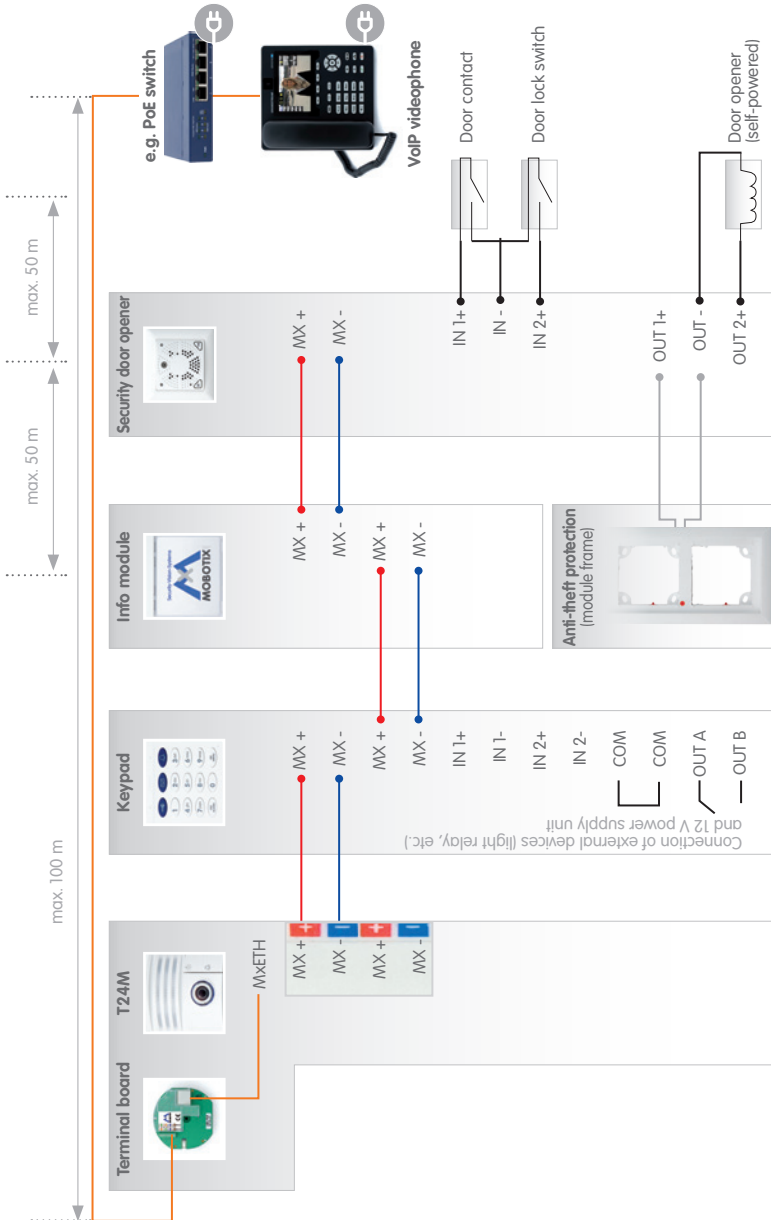

The security door opener is always connected to a free MxBus connector of the outdoor station (on the camera module, keypad or info module)

Modules are connected via the looped-through, two-wire MxBus cable that transfers data and power simultaneously

The module terminal designations are also located directly on the module

2.1.2 T24 Without A Security Door Opener

When a MOBOTIX security door opener is not used, the **electric door opener or Mediator, including the door and door lock sensors, are connected directly to the keypad. In addition, an external 12 V voltage is applied to the door mechanism/Mediator and bridged over to the keypad.**

The two cables for the electromagnetic anti-theft protection integrated into the T24 frame (otherwise connected to and powered by the security door opener) should be conducted inside the building so that they can be connected to a 12 V supply in case modules are exchanged later on.

The figure above the connection sections represents the number of cable wires

Black: YSTY 0.8 (recommended) or 0.6 mm

Orange: Ethernet Cat. 5 or higher

The external 12 V supply can be bridged over from the Mediator to the Keypad to avoid having to use an additional 12 V cable to the keypad

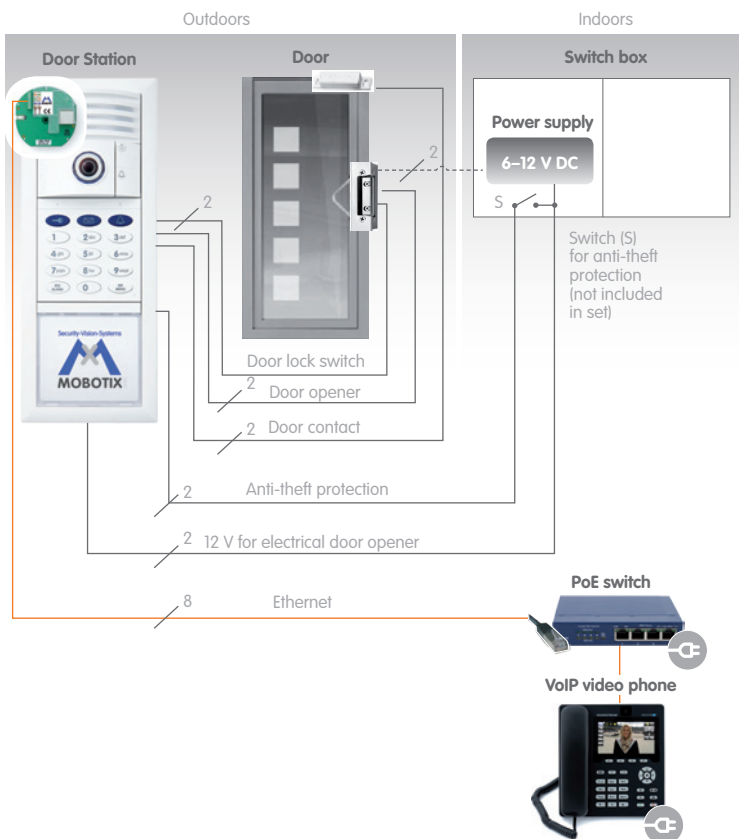

Note

The anti-theft protection is connected to the DC power supply of the door opener via a switch (switch on -> current is flowing -> protection deactivated). If the door opener works with an AC power supply, the anti-theft protection requires its own DC voltage source.

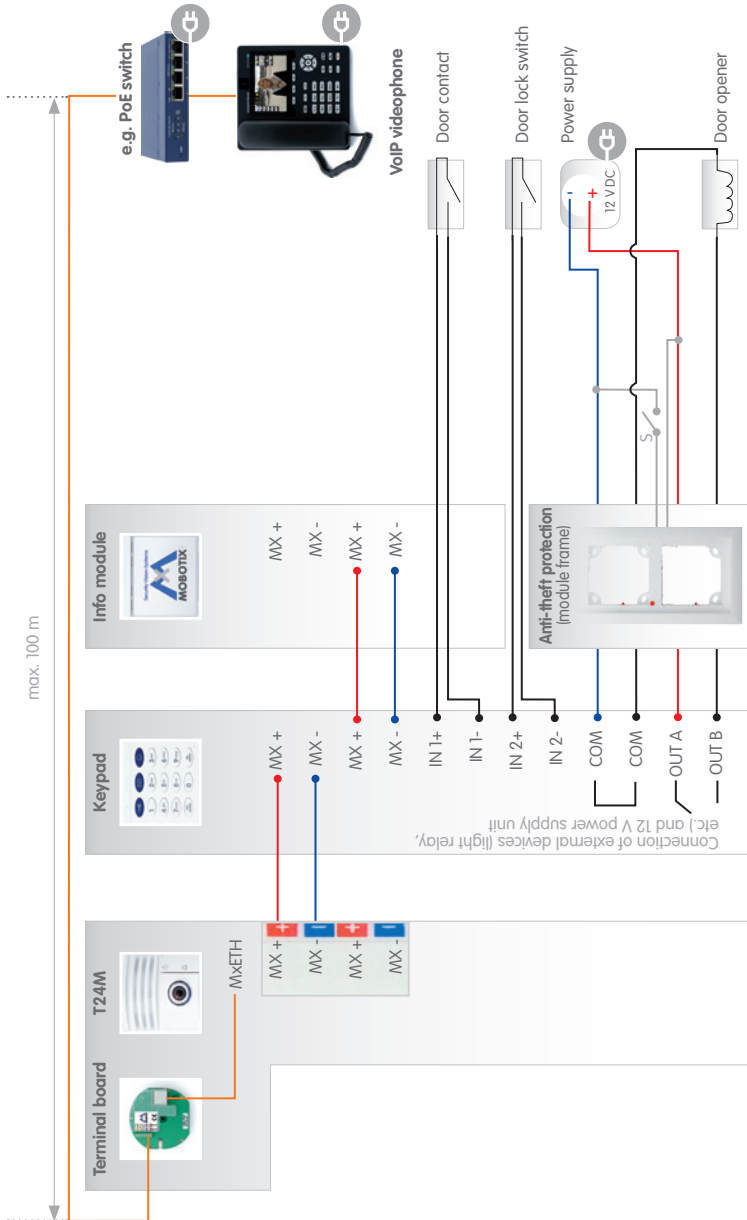

Modules are connected via the looped-through, two-wire MxBus cable that transfers data and power simultaneously (cable included in packaging)

The module terminal designations can be found directly on the module

2.1.3 T24 With Mx2wire And Security Door Opener

To be able to use a bell wire already laid in the building to connect the T24 door station to the network and supply it with power, the T24 version with Mx2wire technology is required. The two-wire cable must be conducted from the door station info module to a second Mx2wire unit inside the building, to which data and power is supplied, for example, via a PoE+ switch.

Installing a MOBOTIX security door opener with decentralized access code memory makes it impossible to open the door by bypassing the connection cable, and therefore protects against unauthorized access. A battery, kept fully charged via Mx2wire at all times, supplies power to the electric door opening mechanism (even in the case of a power failure).

The figure above the connection sections represents the number of cable wires

Black: YSTY 0.8 (recommended) or 0.6 mm

Orange: Ethernet Cat. 5 or higher

The external 12 V power supply including a cable from the switch box is required here for an (optional) Mediator

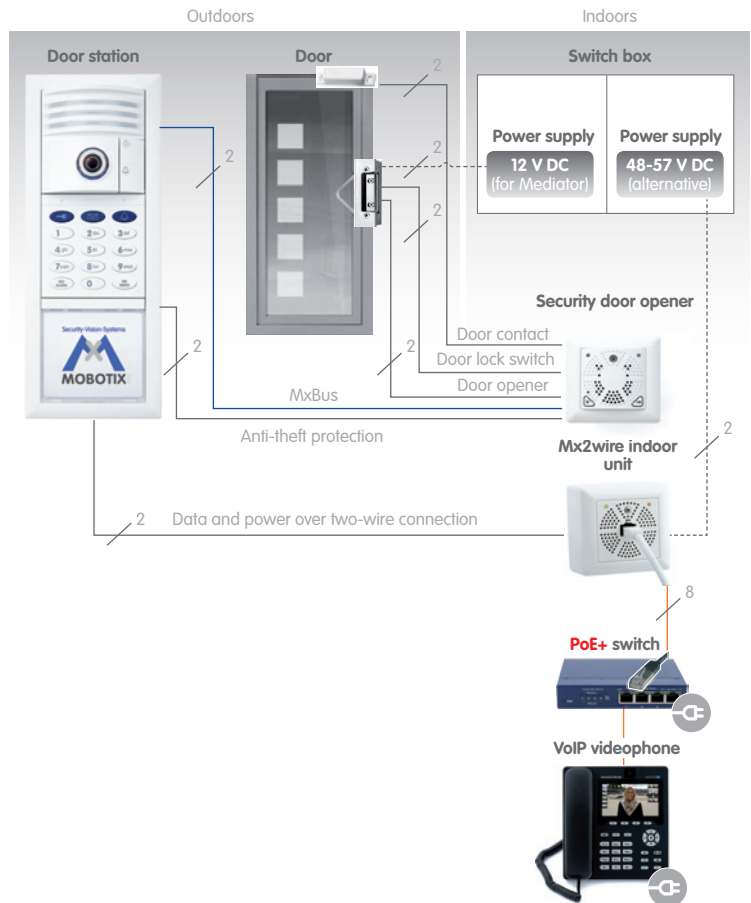

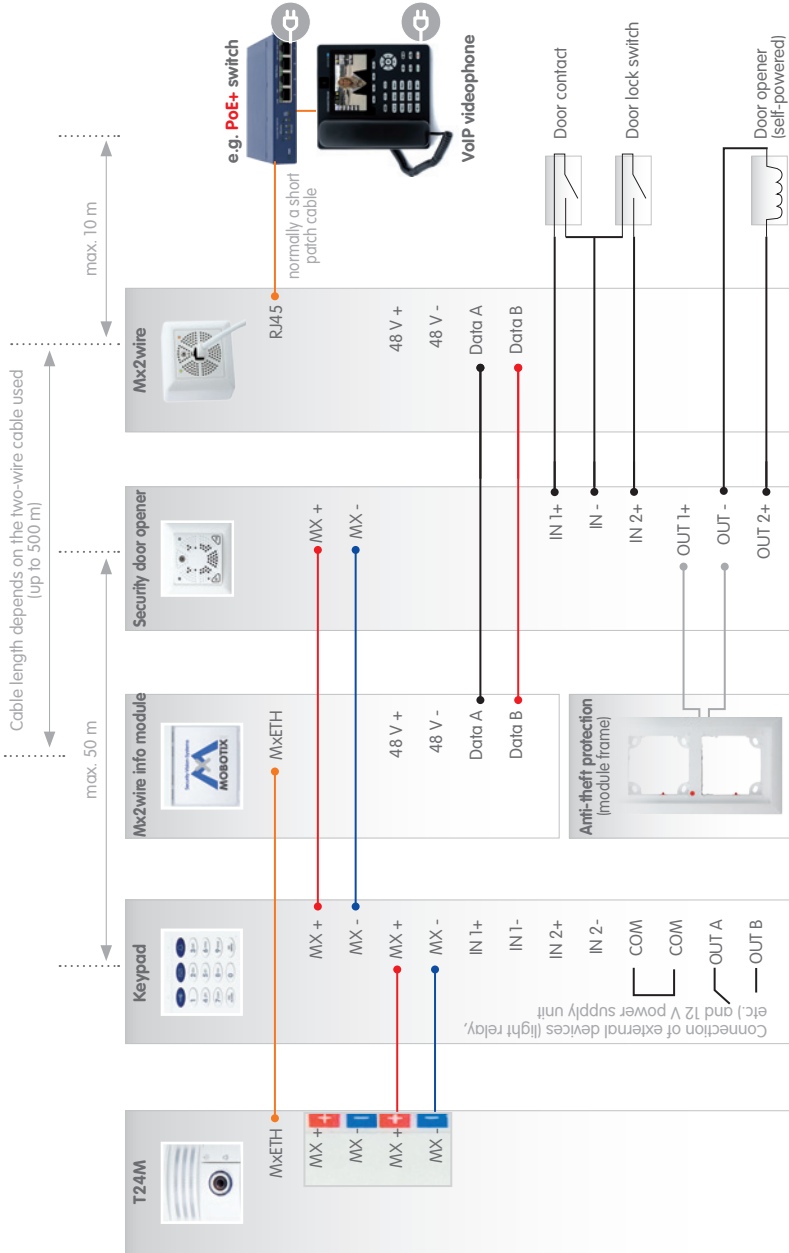

The security door opener is always connected to a free MxBus connector of the outdoor station (on the camera module, keypad or info module)

Modules are connected via the looped-through, two-wire MxBus cable that transfers data and power simultaneously (cable included in packaging)

An Ethernet patch cable is used to connect the Mx2wire info module to the camera

The module terminal designations are also located directly on the module

The maximum configuration is specified for these cabling recommendations

2.1.4 Recommendation For Cabling

Depending on the model, the door station and its remote stations require one of the following cabling configurations. Please take note of our cabling recommendations and the maximum cable lengths. Both the network cable and other cables must be stripped at the door station ends.

- 1 Network cable from the Ethernet terminal board behind the camera module to the switch/injector**

 - **Recommendation:** Category 5 (Cat 5) Ethernet installation cable or higher; Cat 7 cable is designed for 10 Gbit Ethernet (max. future compatibility)
 - **Max. cable length:** 100 m
- 2 Two wires from the door station to the security door opener for the MxBus connector**

 - **Recommendation:** YSTY (telephone) solid wire, core diameter 0.6 to 0.8 mm
 - **Max. cable length:** 50 m
- 3 Cables from the security door opener to the electric door opener, the door contact and the door lock switch**

 - **Recommendation:** YSTY (telephone) solid wire, core diameter 0.6 to 0.8 mm
 - **Max. cable length:** depending on the manufacturer, max. 50 m
- 4 Two wires from the security door opener to an additional power supply (for example, 12 V for Mediator operation)**

 - **Recommendation:** YSTY (telephone) solid wire, core diameter 0.6 to 0.8 mm
 - **Max. cable length:** depending on the manufacturer
- 5 Two wires from the keypad to the 230 V light relay (if present)**

 - **Recommendation:** YSTY (telephone) solid wire, core diameter 0.6 to 0.8 mm
 - **Max. cable length:** depending on the manufacturer
- 6 Two-wire cable from the Mx2wire info module to the Mx2wire indoor unit (as an alternative to the outdoor station being directly connected to the network)**

 - **Recommendation:** existing, previously laid bell wire (core diameter 0.6 to 0.8 mm)
 - **Max. cable length:** 200 m (JY, A2Y, YR), 300 m (NY), 500 m (Cat 7)
- 7 Two wires from the door station to the security door opener for connecting the MOBOTIX anti-theft protection (for unlocking when exchanging modules)**

 - **Recommendation:** black two-wire cable already fitted to the frame, possibly extended with YSTY (telephone) solid wire, core diameter 0.6 to 0.8 mm
 - **Max. cable length:** 50 m

The supplied patch cable is used to connect the Mx2wire info module to the camera

NY: installation cable (not live)

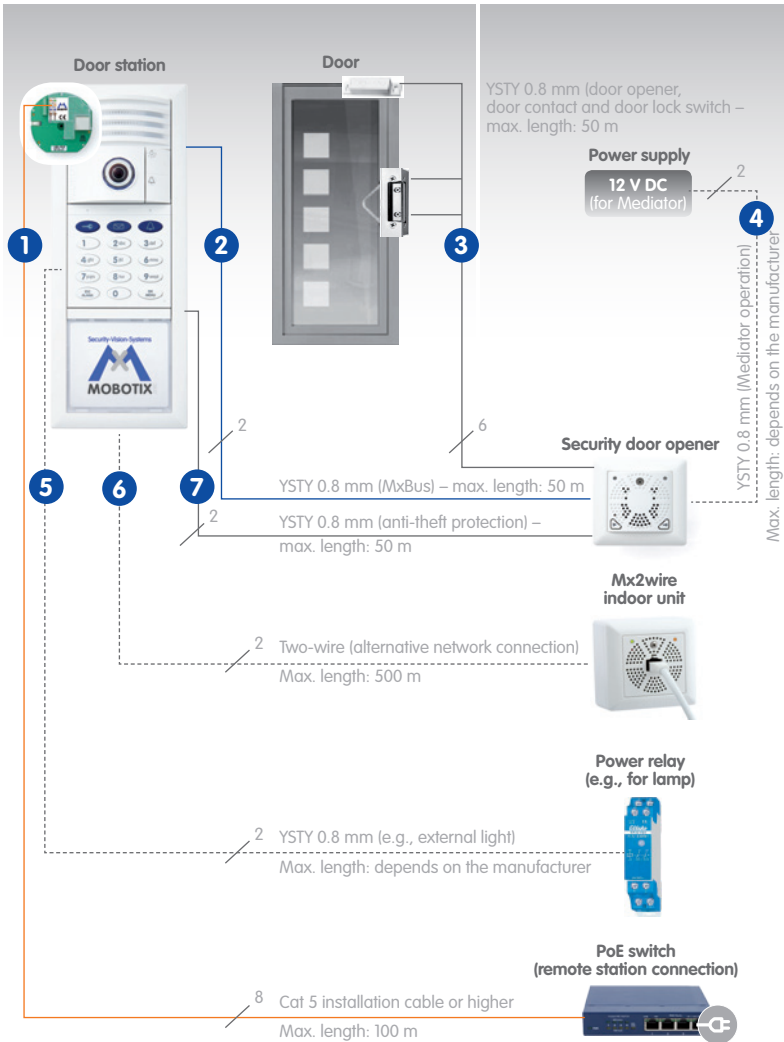

Cable 6 may be used instead of cable 1 (alternative connection option)

2.1.5 Installation Tip: Replacing An Existing Doorbell With The T24

The MOBOTIX T24 IP Video Door Station, in particular the version with integrated Mx2wire technology (for network connection with simultaneous power supply via the same two-wire cable), is an ideal retrofit solution that is very easy and quick to install.

The following two installation steps are normally all that is required to replace an existing, simple doorbell with a complete T24 set including a security door opener:

Step 1: Connect The T24 Via The Two-Wire Cable

Unscrew and remove the doorbell. Connect the wire pair to the Mx2wire info module (T24 is mounted directly above the cable). This wire pair is conducted directly to the electrical cabinet, from where it is connected to the power supply and remote stations via the Mx2wire indoor unit.

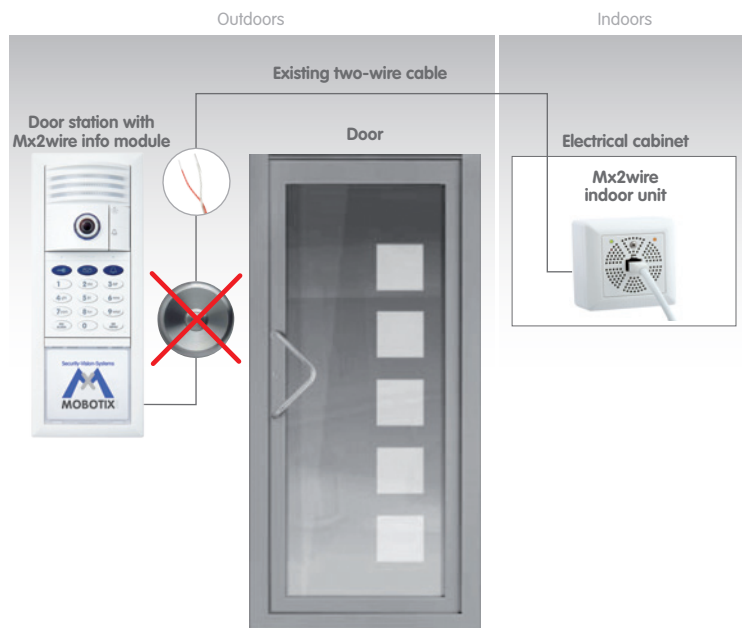

Step 2: Install And Connect The Security Door Opener

Install the security door opener in a in-wall socket on the wall behind the door station (inside the building). Besides the in-wall socket, only two holes are required for the entire cabling.

Hole A

Use a long drill bit to drill a hole from the door station downwards at an angle, through the brickwork to the in-wall socket of the security door opener on the interior wall surface. Insert a 4-wire cable for MxBus and the anti-theft protection (see Section 2.1.4, Recommendation For Cabling).

Hole B

Use a shorter drill bit to drill a hole through the brickwork from the door lock/door opener to the in-wall socket of the security door opener. Feed the connectors for the door opener, door contact and door lock switch through this hole (see Section 2.5, Installing The Security Door Opener).

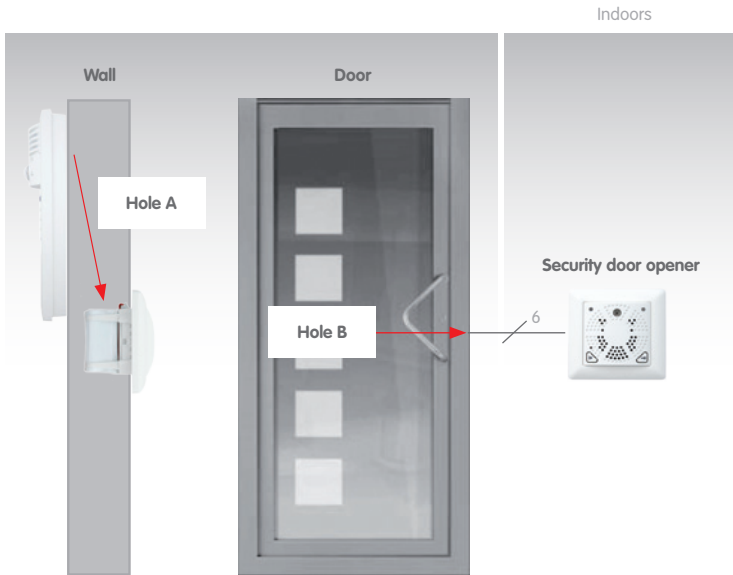

Note

Please contact a specialist (e.g. a locksmith) for the installation and selection of any components that may be required (door opener, magnetic sensors). Door openers and door contacts are available as accessories from other suppliers (e.g. www.assaabloy.com).

2.2 Remote Stations And Network Connection

2.2.1 Notes On Cable Lengths And Power Supply

The T24 door station can only be powered using the Ethernet port of the door camera. A MOBOTIX PoE adapter (MX-NPA-PoE) or other similar, high-quality PoE product conforming to IEEE 802.3af is required to supply the T24 with power (PoE switch). A PoE+ switch (IEEE 802.3at) or a 48 V power supply unit can be used to supply power to the T24 version with Mx2wire technology.

The **maximum length** of the network cable for power supply over an Ethernet cable is **100 m**.

Make sure that you only connect the door station or Mx2wire indoor unit to switches or routers that support the 10/100 Mbps network interface. Check the LED activity of the corresponding port at the switch or router.

2.2.2 Direct Connection Of One Remote Station

If the door station is to be connected for operation to one remote station only (computer with MxEasy or VoIP videophone), MOBOTIX recommends using a MOBOTIX PoE adapter (MX-NPA-PoE) to supply power to the door station. Connect the devices as shown in the following connection diagram:

Connection With MOBOTIX PoE Adapter

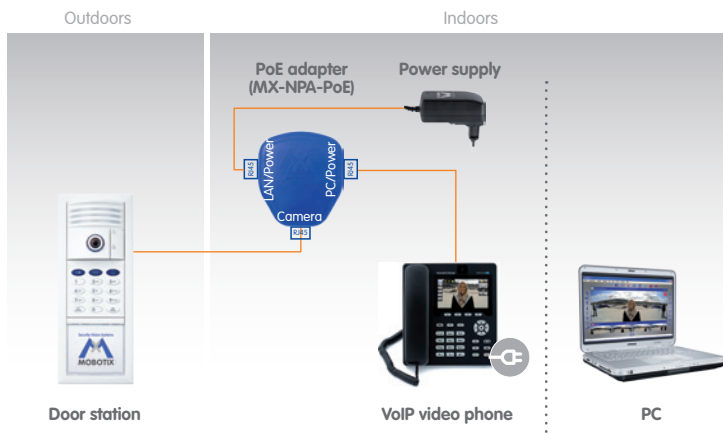

The MOBOTIX PoE adapter (MX-NPA-PoE-SET) features a crossover function for direct computer connection, and can either be connected to the mains supply or to other voltage sources (12-42 V)

Note

The Grandstream videophone has two ETH connectors, and it can alternatively be connected wirelessly to a network using a WLAN stick (USB port).

2.2.3 Network Connection With Multiple Remote Stations

If the door station is to be connected for operation with multiple remote stations (computers with MxEasy or VoIP videophones) in an existing network (for example, via an Internet box), MOBOTIX again recommends using a MOBOTIX PoE adapter (MX-NPA-PoE) or a switch with multiple ports to supply power to the door station. Connect the devices as shown in the following connection diagram:

Connection With PoE Switch

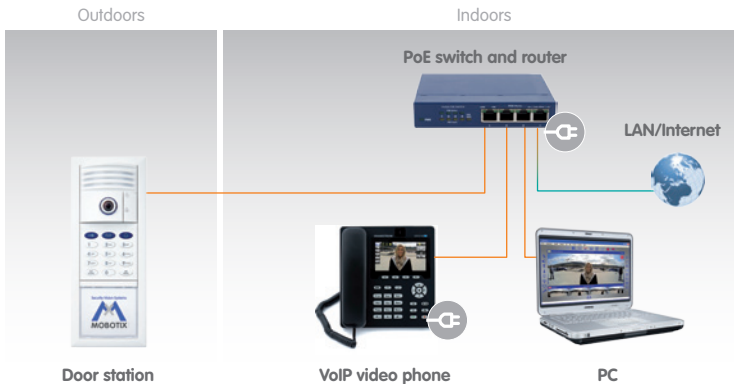

If multiple PoE-supplied end devices (such as several IP cameras) are to be operated, you should consider using a PoE switch

Connection With MOBOTIX PoE Adapter



The T24 (with additional PoE power supply, for example, using the MOBOTIX PoE adapter) and its remote stations can also be connected to an existing WLAN router with integrated switch function (DSL box)

Connection With Mx2wire And Optional 48 V Power Supply

Note

For a door station with integrated Mx2wire technology, an external voltage source (48 V DC) - connected via two wires directly to one of the two Mx2wire units (info module or indoor unit) - can also be used to supply power via the network cable.

An existing DSL box can also be used to connect the Mx2wire indoor unit instead of a switch

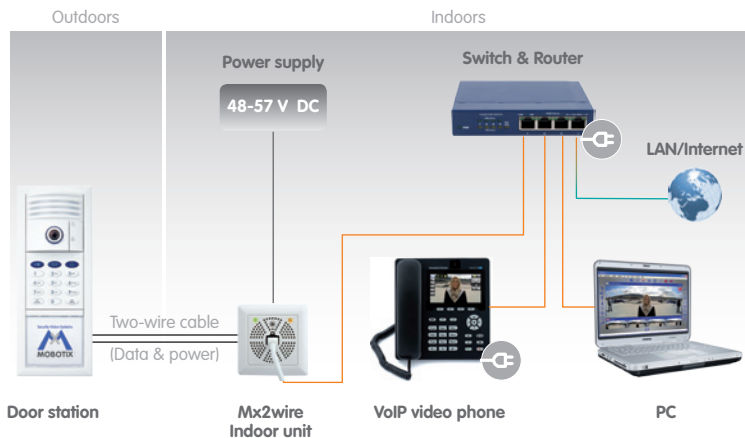

Connection With Mx2wire And PoE+ Switch

Although a PoE+ switch complies with the IEEE 802.3at standard, using a 48 V unit to supply power is normally the more economical option if only one end device powered via PoE+ is to be operated

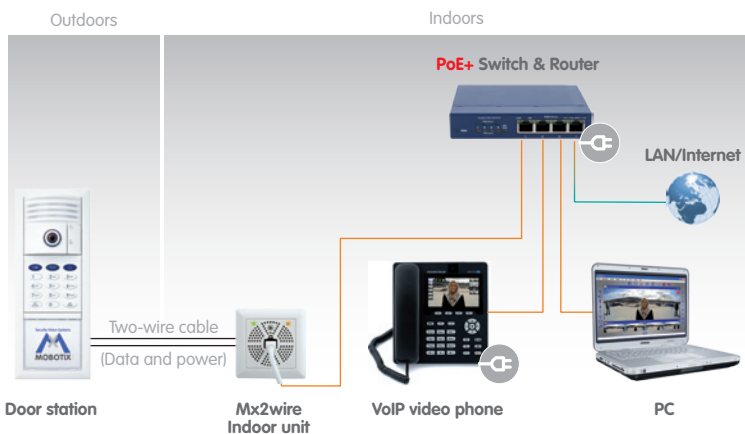

Connecting Multiple T24 Door Stations

In general, a (PoE) switch can be used to connect several T24 door stations to the same remote stations.

However, only one T24 can be connected to a security door opener.

Each transponder card can be programmed in such a way that it can be used on all the existing T24 door stations for opening the door.

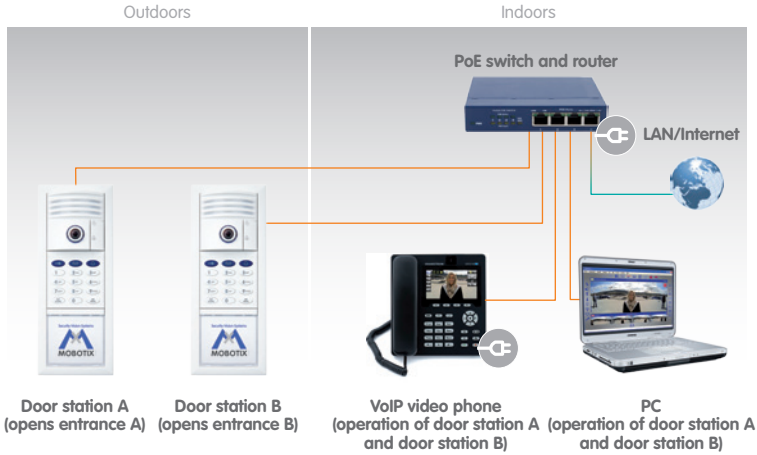

2.3 Mounting The Frame And Housing

A complete T24 door station system includes components that are mounted next to the entrance door, which means they are usually installed outdoors, as well as components such as security door openers, remote stations and power supplies that are installed inside a building.

Please note that only the T24 camera, keypad and info module are suitable for outdoor installation (IP65, -30°C to +50°C/-22°F to +122°F). The modules will only be weatherproof if they have been installed correctly using matching MOBOTIX housings and frames.

2.3.1 Determining The Installation Position

Before installing the door station, you need to decide exactly where to install it. In addition to being mounted vertically (most popular installation option), the door station can also be mounted horizontally.

Hint:

To capture good-quality images at night as well, fit an outdoor light approximately 1 m above the door station (with integrated motion sensor)



Vertical installation



Horizontal installation

In a vertical layout, the camera module is normally positioned right at the top. The keypad is located directly underneath, followed by the info module.

Note

Position the housing directly above the cables that come out of the wall (network, two-wire cables). None of the connection cables should remain visible, as this would make them vulnerable to manipulation.

To ensure ease of use, the system should be installed to accommodate people of different heights. The height from the ground to the upper edge of the frame should be at least 1.60 m.



Unlike conventional door cameras, the T24 camera with its 180° image angle is also able to record visitors when they are NOT standing directly in front of the lens. This means that the door station can be mounted quite flexibly, which is particularly useful with wide doors.



Original MOBOTIX T24 Image: 1280x480

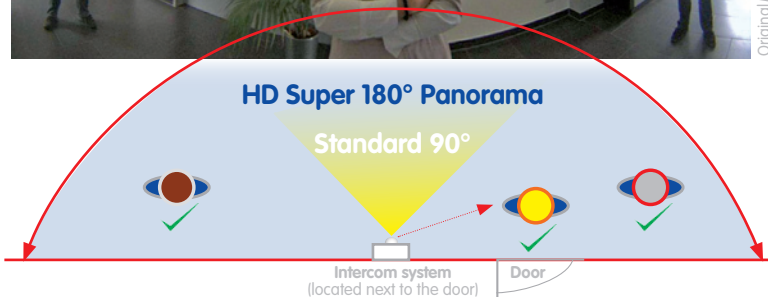

The installation can be on-wall, in-wall or using a cavity socket. MOBOTIX provides two different types of housing for these installation methods. The modules and the frame fitted to the housing are suitable for all installation options.

2.3.2 Inserting All The Cables

On-Wall Housing

The housing has cable guides made of elastic rubber to ensure the cable entry points are waterproof.

Use only one cable guide for each cable. Pierce the cable guide you require using a screwdriver or other similar tool and feed the cable into the housing. If the cable is multi-wire, separate the individual wires once the cable is in the housing.

Hint:

Do not open the cable guides up too wide (for example, if you are using a cutter), as cables fed inside the housing must be tightly enclosed (to ensure a tight seal)

Pierce required guide holes, e.g. with screw driver



Guide cable through hole (one cable per inlet)

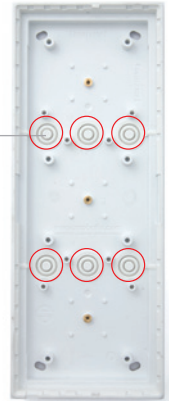

In-Wall And Cavity Housing

Remove the insert and use a screwdriver or similar tool to **pierce through** all the openings on the rear or on sides required for **inserting cables**. As the housing is embedded in the brickwork, this usually makes for a tight seal. If in doubt, or when using a cavity housing, you should additionally seal the cable guides with silicone.

Pierce required guide holes

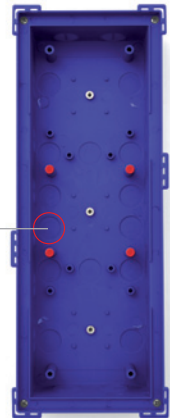

The insert prevents the in-wall housing from getting dirty and being deformed during installation in a wall; it must be removed and then positioned again when preparing the cables

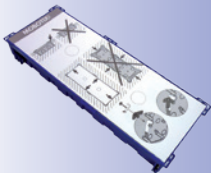

Important: Pay Attention To The Position Of The Cables

When installing the door station, make sure that all the required cables (network, MxBus, anti-theft protection and so on) are laid in such a way that they protrude from the wall directly below the housing openings provided.

This particularly applies to the on-wall housing that has up to six cable guides (triple frame). Only one cable (multi-wire cables may be used) should be inserted into each cable guide. The cables should be long enough so that sufficient cable reserves remain to allow easy cabling within the housing (see Section 2.3.4).

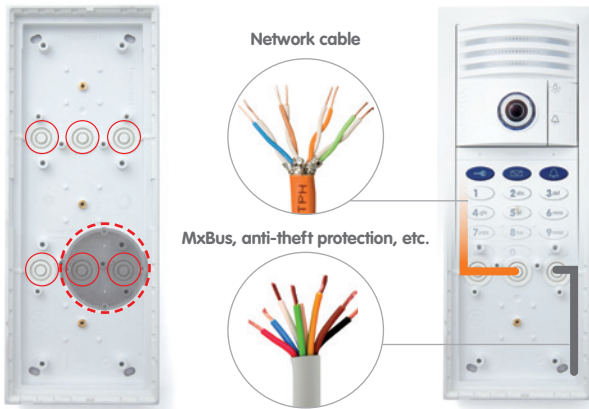

Notes

- Position the housing in the center above the cables
- Only use one cable in each cable guide
- Make sure sufficient cable reserves are provided
- Hint: If longer cable reserves are required, you can mount an additional in-wall socket underneath the on-wall housing (see the dashed line in the figure above).

2.3.3 Attaching The Housing

On-Wall (Fig. Triple Housing)

Drill the four holes and insert the screw anchors (drilling template is included). Ensure that the 'Oben/Top' label points upwards (applies to horizontal and vertical installation). Attach the on-wall housing using four Torx screws and the supplied Torx wrench.



Horizontal installation



Vertical installation

The required installation opening has the following dimensions (width x height):

Single housing: 117 x 129 mm

Double housing: 117 x 218 mm

Triple housing: 117 x 318 mm

Permissible wall thickness
min. 7 mm/max. 27 mm



Cavity (Fig. Triple Housing)

When installing the housing in a cavity wall, tighten the cross-head screws embedded in the housing corners until the four retaining wings swing out and clamp the housing tightly to the cavity wall.

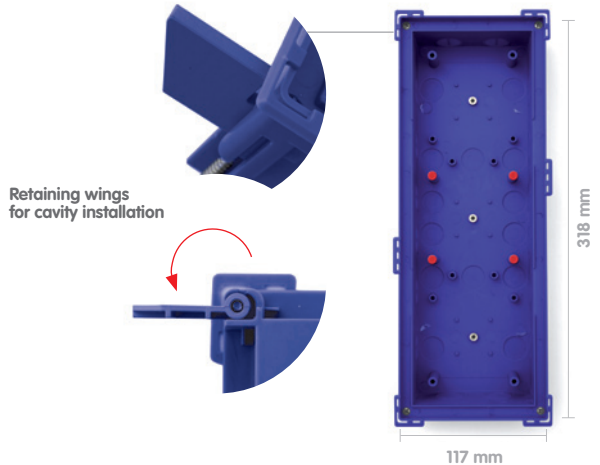

In-Wall (Fig. Triple Housing)

Connect the housing with the subsurface so that the bars fitted to the edge are still visible. The required opening should be 116 x 318 mm. Turn the housing over and use it as a template to mark the holes.

Dimensions for installation opening (W x H x D):

- Single housing: 117 x 129 x at least 52 mm
- Double housing: 117 x 218 x at least 52 mm
- Triple housing: 117 x 318 x at least 52 mm



Hint: Turn the in-wall socket over and use it as a template to mark the hole

Leading edge of housing flush with wall



Caution

Make sure to install the in-wall housing carefully **using the inserted protective cardboard** so that it is not deformed by any pressure from the surrounding material. Otherwise the frame may not be installed properly and may not be sealed against the weather.

To prevent cement or plaster from soiling the inside of the housing, insert the supplied **protective cardboard again before installing the housing in the subsurface of the wall**. After you have secured the in-wall housing, you can easily remove the protective cardboard by pushing through the pre-punched opening and simply pulling out the cardboard.

Pierce opening hole and pull through cardboard

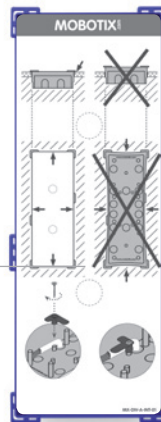

2.3.4 Cabling In The On-Wall Housing

To prevent cables from being damaged when you mount the frame or the T24 modules, make sure that the cables are routed correctly. Please refer to the example cabling shown in the figure below. The packaging material contains four blue cable binders that can be secured to eight designated cable receptacles using screws (**recommendation: cross slot PH 2x100**).

Several cable binders are included in the delivery kit



Mounting points for cable binders (8x, marked yellow)

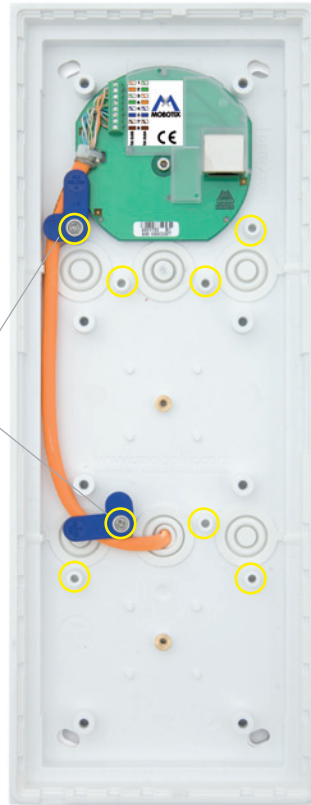

The T24 housing (on-wall/in-wall) provides sufficient space for cable reserves (see the blue dashed line in the figure).

The red areas are 'off-limits areas'. No cables should be placed in this area (risk of damage to cables when module is mounted).

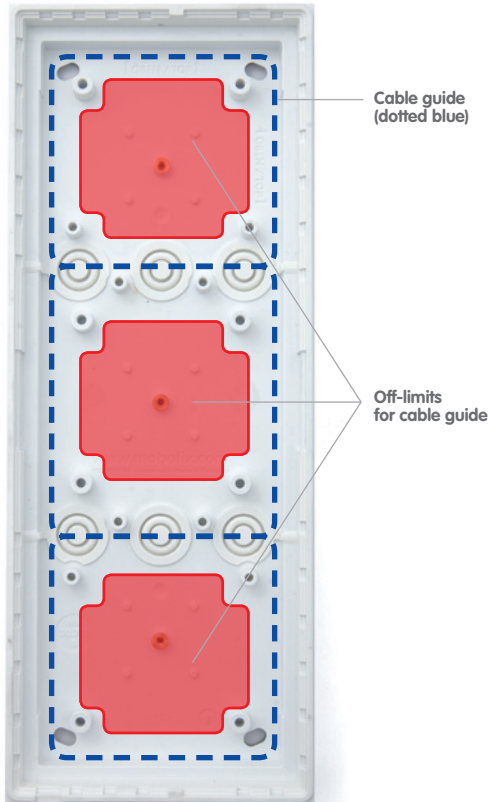

The in-wall housing provides sufficient space - there are no off-limits areas



2.3.5 Mounting The Terminal Board And Fitting The Network Cable

Mounting The Ethernet Terminal Board

Screw the board into the housing (flattened side is at the bottom). **The terminal board must be placed behind the camera module.** This step is not necessary for the T24 version with Mx2wire technology (two-wire cable replaces Ethernet cable), as an Ethernet terminal board is not required.



For connecting external devices, an expanded terminal board (MX-OPT-IO1) can be mounted in place of the Ethernet terminal board (see Section 2.7.2)



Attachment of board for vertical and horizontal installation



Stripping And Fitting The Network Cable

The Ethernet terminal board provides a link from the network installation cable to the special patch cable of the camera module mounted directly above.

Connect the eight wires of the installation cable (with stripped ends) to the corresponding contacts on the terminal board in accordance with the sticker (**fig. standardized color coding according to TIA-568B**). Fasten the network cable so that its shielding rests on the terminal board contact field (using the enclosed cable tie).

Follow these measurements when stripping the cable

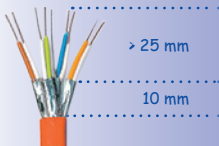

Check whether the network cable at the other end (e.g., PoE switch) is wired according to 568A or 568B (see sticker)

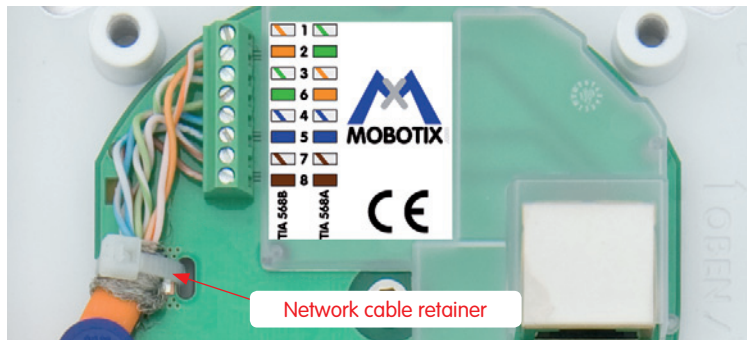

2.3.6 Sticking The Seal In Place

Remove the protection film and stick the supplied seal all the way round the inner housing frame, ensuring it fits exactly and taking care not to leave any gaps.

Use a pair of scissors to remove any surplus material. Please ensure that the adhesive surface is clean, dry and free of grease.

On-Wall Housing

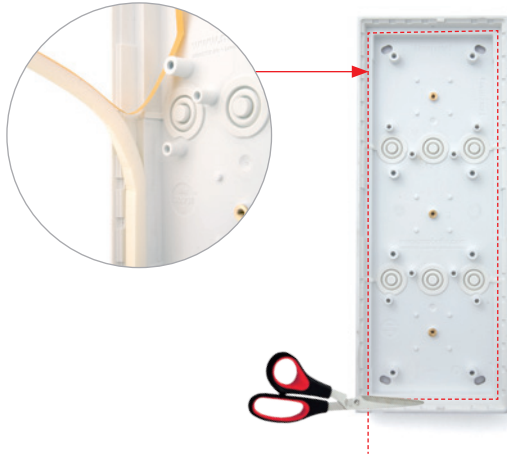

Stick the seal to the inner frame as shown in the figure

In-Wall And Cavity Housing

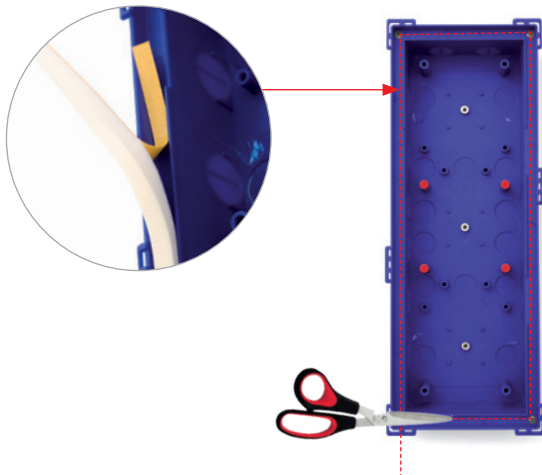

Stick the seal to the inner frame as shown in the figure

2.3.7 Attaching The Frame And Connecting The Anti-Theft Protection

Before the T24 modules can be clicked into the frame, you must screw the frame onto the housing (**recommendation: cross slot PH 2x100**) and lay the black anti-theft protection cable to the inside of the building according to your selected connection option, for example, to the security door opener (you may also need to extend the cable). When you attach the frame, make sure that the two openings for the special MOBOTIX key - which is used to remove the door station modules - are located either on the bottom left (vertical mount) or on the bottom right (horizontal mount), and that the maximum torque for the frame screws is not exceeded.

On-Wall (Fig. Triple Housing)

Frame alignment for vertical and horizontal mounting (red arrow points to the keyhole)

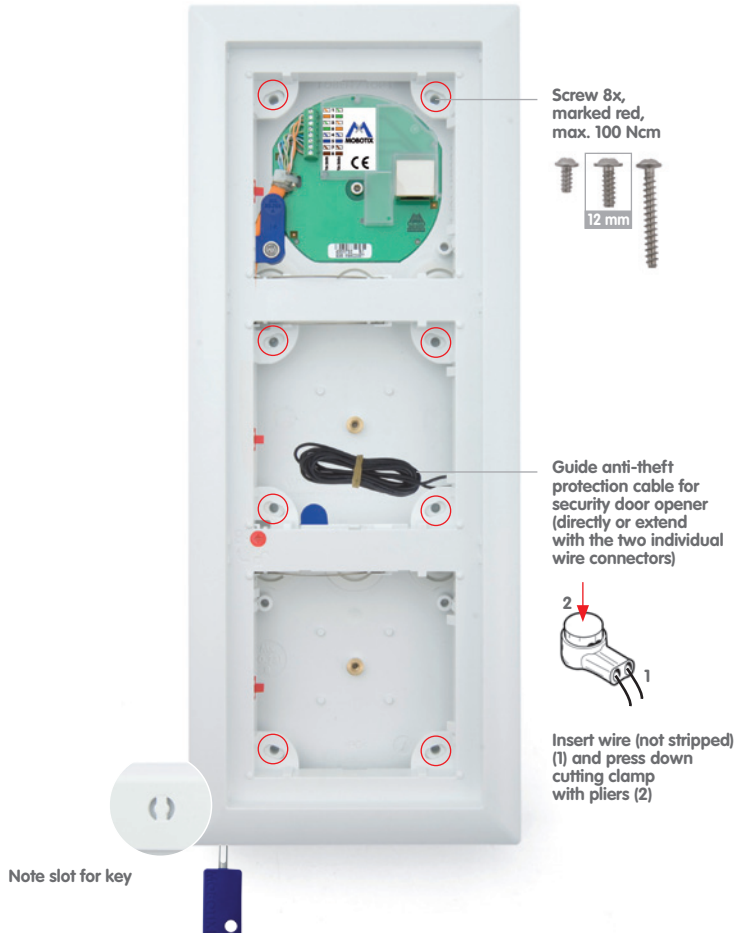

Cavity And In-Wall (Fig. Triple Housing)

Please note that in this case the module frame may only be screwed onto the four outermost positions on the housing (max. torque: 40 Ncm).

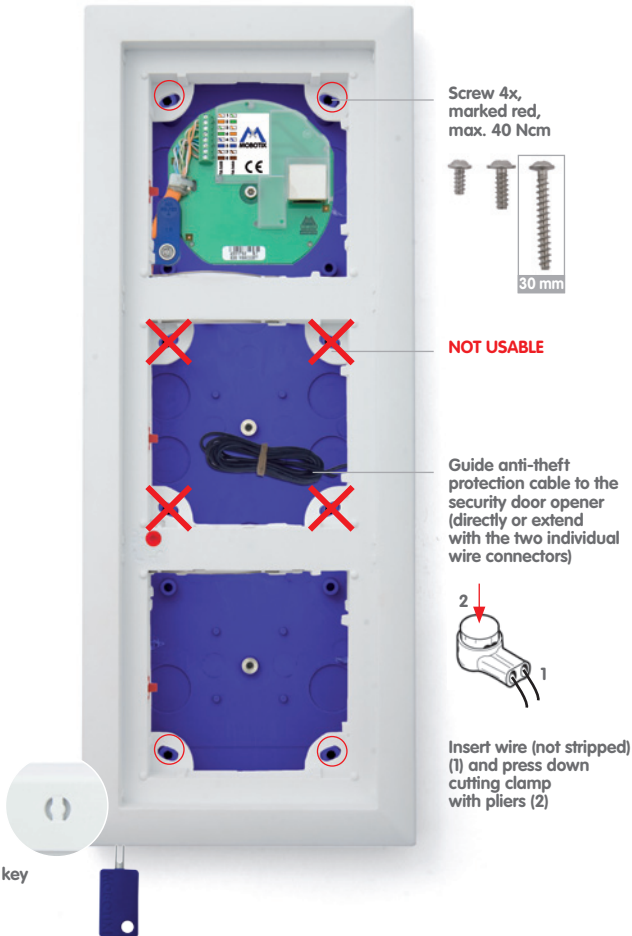

Frame alignment for vertical and horizontal mounting (red arrow points to the keyhole)

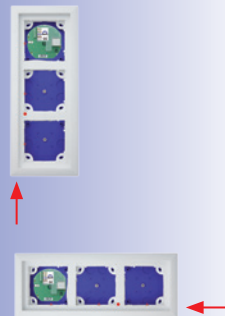

2.3.8 Mechanical Anti-Theft Protection Lock

In the default configuration of the door station, anti-theft protection is **not activated** in the frame. This allows modules that have already been integrated to be removed again during the installation, just using the special key that has been supplied.

Insert the key into the opening provided and apply light pressure. The red retaining collars on the left or lower side of the frame (depending on whether the frame is mounted vertically or horizontally) loosen and release the modules.

Special key



Notes

To activate the mechanical anti-theft protection lock, the module above the **red rotary button** (triple frame: center module, double frame: upper/left module) must be released from the frame.

Important: After the installation, check the wiring (see Section 2.8.1) and only then activate the anti-theft protection lock.

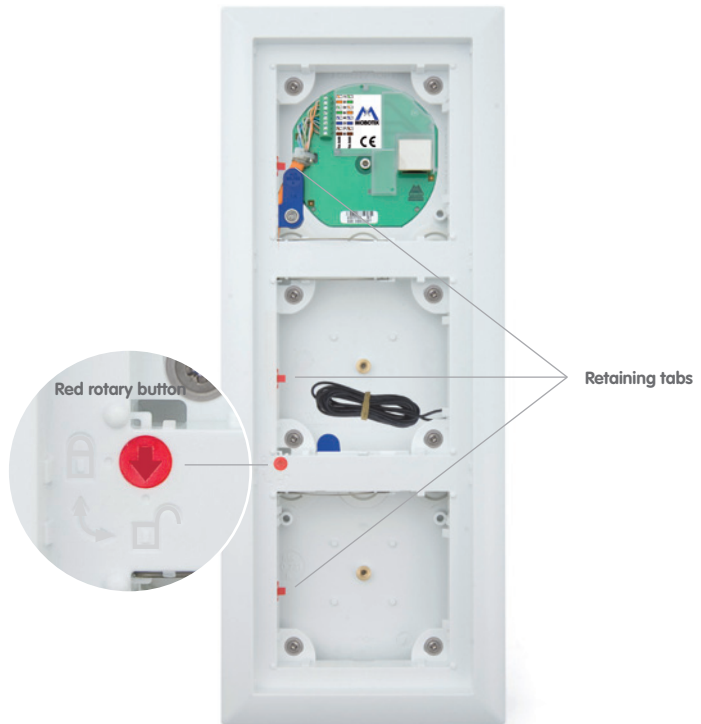

Activating The Anti-Theft Protection Lock

Use a screwdriver to turn the red rotary button inside the frame 90 degrees clockwise. When anti-theft protection is activated, the arrow points to the **'closed lock' symbol**.



In this position, using the special key alone to release the modules from the frame is not possible.

Deactivating The Anti-Theft Protection Lock

Turn the red rotary button so that the arrow points to the **'opened lock' symbol**.



In this position, you can use the special key alone to release the modules from the frame.

2.4 Installing The T24 Modules

Caution

Beware of short circuits: When you install the modules, the MxBus cable should not be live, which means that the network cable should still be disconnected from the PoE switch.



2.4.1 Installing The Camera Module

Standard Network Connection

The Ethernet terminal board is used to connect the door station for the T24 version without Mx2wire technology. It connects the short, pre-installed camera patch cable with the eight split-out wires of the network installation cable (for installation, see Section 2.2.5).

1. Ensure that the **seal** is fitted to the camera module.



2. Connect the supplied **MxBus cable to the push terminal on the rear wall of the camera**. Remove approximately 5 mm of insulation from the cable ends and push into the terminal.

- **Red wire to + terminal**
- **Blue wire to - terminal**



Note

To connect the MxBus cable of the **MOBOTIX security door opener**, the two free MxBus terminals of the camera module can be used as an alternative to the MxBus terminals on the keypad or info module (see Section 2.5).



Do **not** swap the + and - wires

When using a different-colored cable, make sure the correct polarity is routed



3. Guide the **MxBus cable** (to be shortened accordingly) into the housing and under the frame so that it can be easily connected to the keypad later on. Insert the pre-installed camera module **patch cable** into the RJ45 port on the terminal board.

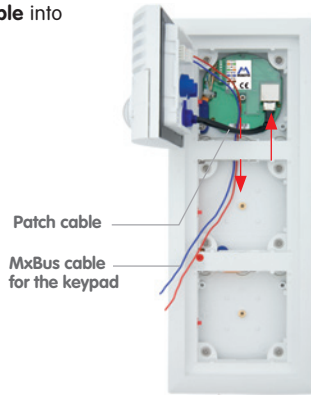

4. First of all, insert the **right side of the module into the frame** and then press firmly on the **left side**, until the module audibly **clicks** into place.



Pay attention to the off-limits areas for cables reserves (see Section 2.3.4)

With horizontal mounting, the modules must first be positioned **at the top** and then pressed downwards firmly

Control click: If you do not hear a click, this means that the module is not properly locked into place. In this case, repeat the last steps, making sure that no cable or foreign object in the housing is preventing the module from properly clicking into place.

Network Connection Via Mx2wire Technology

An Ethernet terminal board is not required for the T24 door station with Mx2wire technology. Instead, the camera module is connected to the Mx2wire info module via a MOBOTIX patch cable.

1. Ensure that the **seal** is fitted to the camera module.



2. **Remove the pre-installed camera module patch cable** and instead insert the supplied, **longer patch cable** into the camera housing. Make sure that the blue rubber sealing ring is in the correct final position.



Attach the longer patch cable for the Mx2wire info module

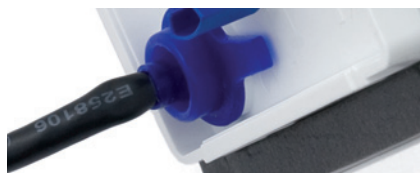

3. Feed the **MxBus two-wire cable** from the camera (installation as described in Section 2.4.1) together with the newly fitted **patch cable** into the housing and under the frame, so that the MxBus cable can be fastened to the keypad board and the patch cable to the info module.

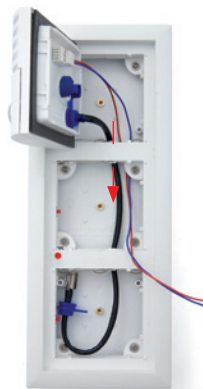

4. First of all, insert the **right side of the module into the frame** and then press firmly on the **left side**, until the module audibly **clicks** into place.

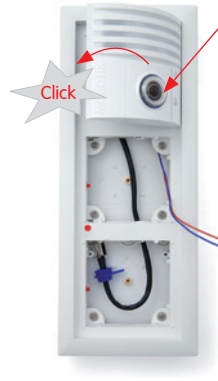

Control click: If you do not hear a click, this means that the module is not properly locked into place. In this case, repeat the last steps, making sure that no cable or foreign object in the housing is preventing the module from properly clicking into place.



2.4.2 Installing The Keypad

Please pay attention to the different system wiring configurations that apply (described in Section 2.1), depending on whether or not the MOBOTIX security door opener and external devices such as a light are used.

1. Ensure that the **seal** is fitted to the keypad.



2. Loosen the **rear cover plate** (using a small screwdriver or similar tool) and remove it. You now have a clear view of the connectors located directly on the keypad board.



3. Remove **approximately 5 mm of insulation** from each of the cables to be connected and feed each cable through one of the **wire apertures** in the housing (piercing the rubber membrane).



4. Connect the two **MxBus cables** that come from the camera module to the **keypad board**.

- **Red wire to MX + terminal**
- **Blue wire to MX - terminal**

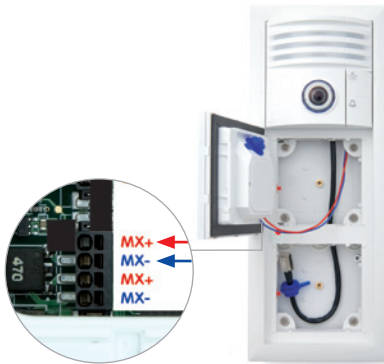

See the circuit overview diagram on the next page

5. Connect **two new MxBus cables to the keypad board**, and subsequently connect these to the info module to power its backlighting. Make sure that the cables are of the required length and that they are routed correctly (does not apply to Mx2wire info module).

- **Red wire to MX + terminal**
- **Blue wire to MX - terminal**

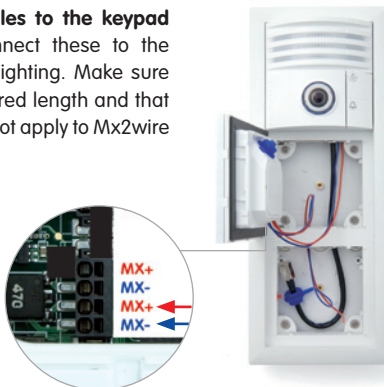

Do not swap the polarity of the + and - MxBus wires

Note

If the info module is connected to the MxBus connector of the door camera, the two MxBus cables of the **MOBOTIX security door opener** can be connected to the keypad instead.

If **no lighting function** is required for the info module at all, the MxBus cables do not need to be connected to this module.



6. Connect all the other connection cables (if present):

Standard door opener or relay (for lights etc.):

- First wire to COM terminal
- Second wire to OUT A terminal

External power supply for door opener or power relay (for example, 12 V AC):

- First wire to OUT B terminal
- Second wire to COM terminal

'Door opened/closed' door contact (reed switch):

- First wire to IN 1+ terminal
- Second wire to IN 1- terminal

'Door lock unlocked/locked' door lock switch:

- First wire to IN 2+ terminal
- Second wire to IN 2- terminal

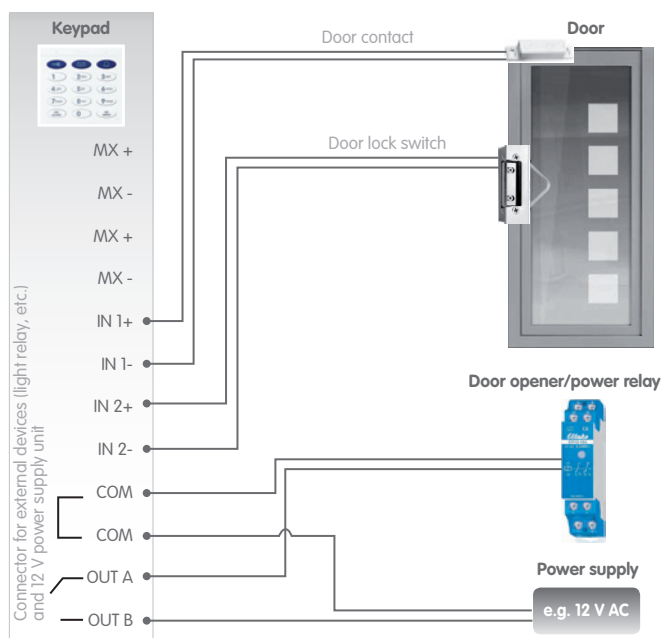

- Put the **cover plate** back on.



- First of all, insert the **right side of the module into the frame**. Then press firmly on the **left side**, until the module audibly **clicks** into place.



Only press firmly on the edge of the keypad (not in the middle)

Control click: If you do not hear a click, this means that the module is not properly locked into place. In this case, repeat the last steps, making sure that no cable or foreign object in the housing is preventing the module from properly clicking into place.

Caution

Do not activate the **anti-theft protection lock** until you have checked the wiring (see Section 2.8.1). Also test the functionality of the anti-theft protection (see Section 2.4.6).



2.4.3 Installing The Info Module

The info field in the info module of the T24 door station without Mx2wire technology is equipped with permanent LED backlighting supplied via MxBus.

1. Ensure that the **seal** is fitted to the info module.



2. Loosen the **rear cover plate** (using a small screwdriver or similar tool) and remove it. You now have a clear view of the connectors located directly on the info module board.



3. Remove **approximately 5 mm of insulation** from each of the cables to be connected and feed each cable through one of the **wire apertures** in the housing (piercing the rubber membrane with the cable).



4. Connect the two **MxBus cables** that come from the keypad to the info module board.

- **Red wire to MX + terminal**
- **Blue wire to MX - terminal**



As an alternative to the terminals on the keypad or info module, you can use the two free MxBus terminals of the camera module to connect the security door opener (see Section 2.5)

5. Put the **cover plate** back on.



6. First of all, insert the **right side of the module into the frame**. Then press firmly on the **left side**, until the module audibly **clicks** into place.



Always mount the module so that the bar with the **MOBOTIX** lettering is at the top



Control click: If you do not hear a click sound, this means that the module is not properly locked into place. In this case, repeat the last steps, making sure that no cable or foreign object in the housing is preventing the module from properly clicking into place.

2.4.4 Installing The Mx2wire Info Module

The info module with integrated Mx2wire technology is used to connect the door station to the network via a two-wire cable such as a bell wire and has an info field with permanent LED backlighting.

1. Ensure that the **seal** is fitted to the info module.



2. Loosen the **rear cover plate** (using a small screwdriver or similar tool) and remove it. You now have a clear view of the connectors located directly on the info module board.



3. Remove **approximately 5 mm of insulation** from each of the cables to be connected and feed each cable through one of the **wire apertures** in the housing (piercing the rubber membrane with the cable).



4. Connect the **two-wire cable**, which leads to the separate **Mx2wire unit in the building**, to the board.

- **First wire to Data 1 terminal**
- **Second wire to Data 2 terminal**



Mx2wire indoor unit
(for installation,
see Section 2.6)



- 5. Remove the blue **sealing plug** on the module. Feed the **RJ45 connector of the (extended) camera patch cable** into the housing and insert it into the RJ45 port. Make sure that the **rubber sealing ring** on the patch cable is in the correct final position.



- 6. Put the **cover plate** back on.



- 7. First of all, insert the **right side of the module into the frame**. Then press firmly on the **left side**, until the module audibly **clicks** into place.



Control click: If you do not hear a click, this means that the module is not properly mounted. In this case, repeat the last steps, making sure that no cable or foreign object in the housing is preventing the module from properly clicking into place.

Always mount the module so that the bar with the **MOBOTIX** lettering is at the top



2.4.5 Labeling Info Module And Mx2wire Info Module

The info module allows you to place a paper label or printer label behind the transparent cover. You can use the enclosed permanent marker to personalize the paper insert by adding your name, contact number, house number and so on.

You will find a PDF template on the MOBOTIX website to help you create your own label. Simply add your personal data to the template and print it onto a sheet of A4 paper. Then simply cut out your 'doorbell label' and insert it into the info module. Before you do this, you will need to remove the info module from the door station frame (see Section 2.4.6 that follows).

Note

To create a doorbell label that goes with a keypad, please make sure to familiarize yourself beforehand with how to configure and operate the door station (see Part 2 of the System Manual).

Proceed as follows:

1. Make your **personalized doorbell label**. To do this, customize the PDF template (Info_Panel.pdf) provided on the MOBOTIX website (www.mobotix.com).



2. **Loosen the transparent protective cover** on the info module by hand or using a screwdriver, which you position on the side (as shown in red) and use as a lever.



3. Tilt the **protective cover downwards** and remove the silicone mat and paper insert.



- Place your completed doorbell label (B) behind the transparent protective cover (A). Insert the silicone mat (C) so that its smooth side is behind the label.



Protective cover (A) Doorbell label (B) Silicon matt (C) Info module (D)

Follow the correct order (from left to right)

- Position the **protective cover at the bottom of the info module (D)** and press the top of the cover until it clicks in place. Now, you can click the info module back into the door station frame.



Info_Panel.pdf (available at www.mobotix.com)

Here are a few examples of doorbell labels that were created using the PDF file template. To open the file requires Adobe Acrobat Reader (free).

Adobe Acrobat Reader: download from www.adobe.com

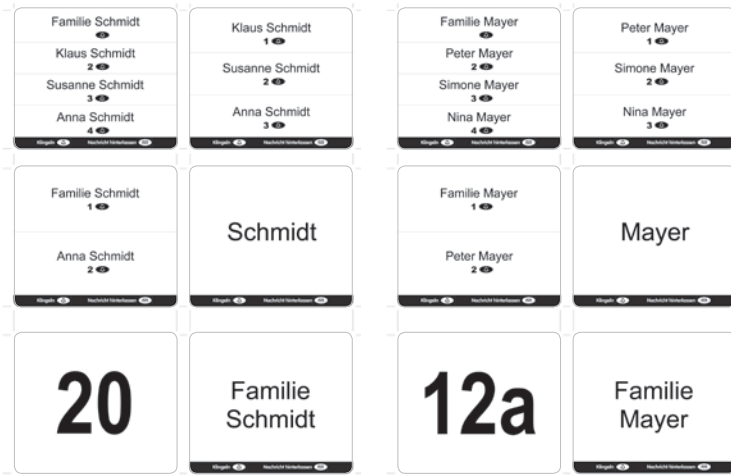

2.4.6 Removing And Exchanging Modules

If anti-theft protection has been activated (see Section 2.3.7), you will need to switch this off before you can remove and exchange the modules.

1. **Switching off anti-theft protection on the security door opener:** Press both buttons on the MOBOTIX security door opener at the same time for ten seconds to deactivate the anti-theft protection for 90 seconds (blue LED blinks). After this, the protection will be automatically reactivated.



Hold at the same time until the blue LED flashes

2. **Switching off anti-theft protection when there is no security door opener:** Connect the two cables of the anti-theft protection to the 12 V power supply of the electric door opener via a switch. Anti-theft protection is deactivated for as long as the voltage is applied (switch on).

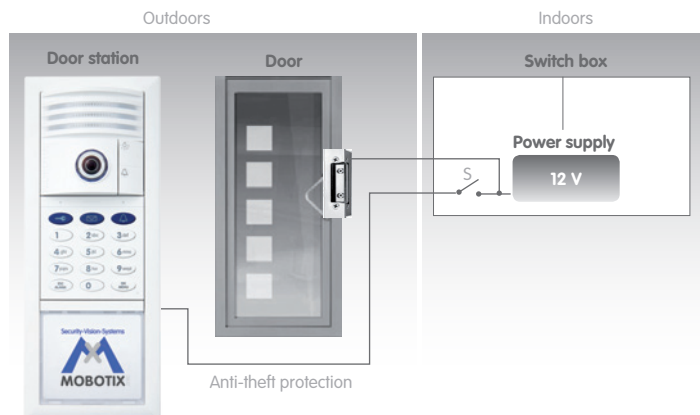

Caution

The anti-theft protection must be disconnected from the voltage again (switch off) **after no more than five minutes** in order to avoid an overload.



- Removing the modules:** Insert the special MOBOTIX key provided into the split opening on the module frame (bottom left or bottom right, depending on how it has been mounted) and release the modules from the frame by pushing the key in. All the modules in the frame move slightly forward and can be removed. Click (listen for "click" sound) any modules that you do not wish to remove back into place.



The MOBOTIX special key is included with the door station



Caution

Make sure that the anti-theft protection has been deactivated before you insert the key, otherwise you risk damaging the frame.



2.5 Installing The Security Door Opener

2.5.1 Overview Of Connectors

The MOBOTIX security door opener is connected to the door station via the **MxBus two-wire cable** and the two wires of the **anti-theft protection cable**.

In addition, the four cables of the **door signal contacts** and the two cables of the electrically operated **door opening components (standard door opener, Mediator)** can also be connected to the MOBOTIX security door opener (see Section 1.2, Technical Specifications).

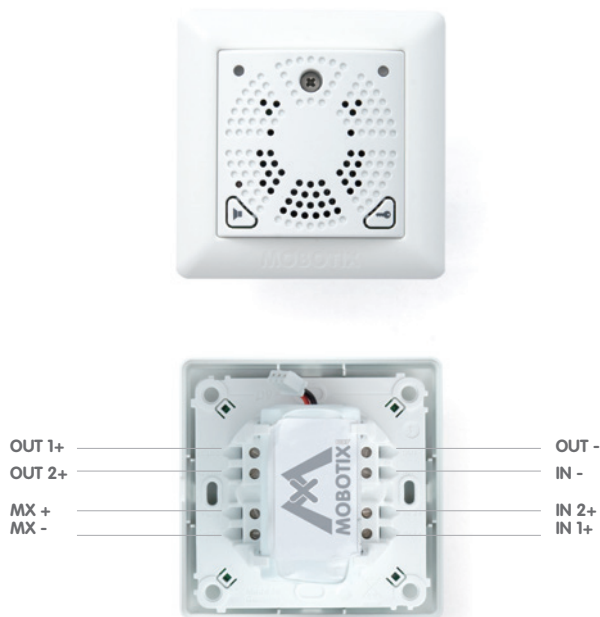

The main function of this innovative device is to control the door opener in a tamper-proof manner and record the status of the door (open, closed, closed and locked). The security door opener, with its speaker that can be switched off, also functions as a doorbell. It furthermore allows the door to be opened using a button and controls the anti-theft protection in the T24 housing.

Thanks to its built-in batteries, which are kept fully charged via the MxBus cables, the security door opener is able to power both the keypad in the outdoor station and a connected door opener for several hours in the case of power failure, therefore ensuring that the door can still be accessed without a key.

Integrated emergency
unlocking function

Security Door Opener System Overview

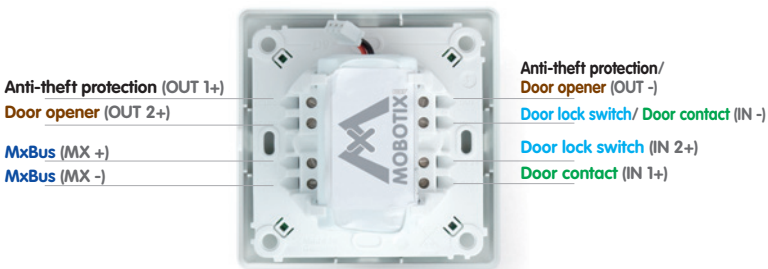
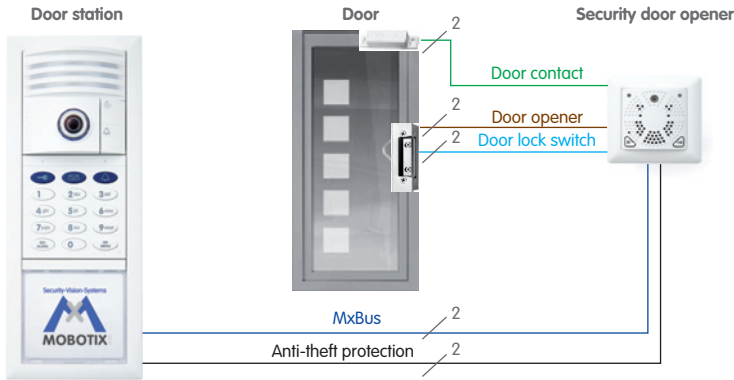

Supported Door Opener Versions

A standard door opener operated with 6 to 12 V AC can be connected directly to the security door opener and powered by its integrated battery pack. There is no need to connect an additional power supply unit.

A door opener with an external power supply of up to 24 V AC/DC (max. 1 A) may also be connected, as may the self-locking Mediator door lock.

The security door opener must be configured for the selected door opener version (see Section 2.8.2)

2.5.2 Connection Diagrams For Door Opener Versions

Version 1: Power Supply From Security Door Opener Battery (Self-Powered)

The MOBOTIX security door opener's permanently-charged battery pack provides a supply voltage to the door opener and therefore also bridges power failures.

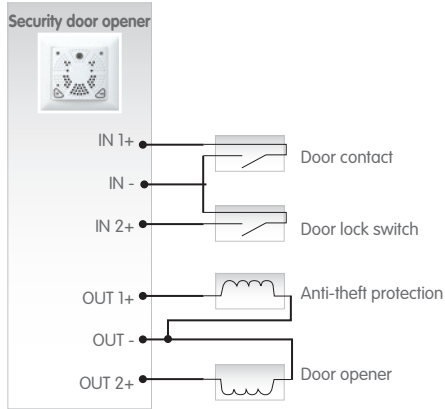

Self-powered
(standard version)

Use the enclosed three-wire connector for terminals that are assigned two wires (IN-/OUT-) (insert unstripped wires and press down cutting clamp with pliers)



Version 2: Power Supply From External Power Supply Unit (Internal Relay Function)

The MOBOTIX security door opener's integrated relay function switches a maximum external voltage of 24 V (SELV, max. 1 A).

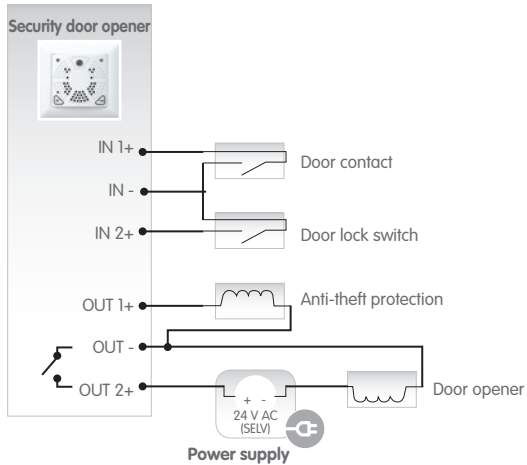

The MOBOTIX security door opener has an integrated relay function

Version 3: Self-Locking Mediator Door Lock Including UPS Via Battery Pack

In this connection option, the security door opener's battery pack powers the system in the event of a power failure and allows the door to be opened without a key. In this case however, anti-theft protection must be controlled using an additional switch (to be ordered separately).

In the following diagram, for example, anti-theft protection is used together with a Mediator power supply. The modules can then be released by pressing the switch.

Note

The anti-theft protection must be disconnected from the voltage again after no longer than five minutes (in the example switch 'S' is off) in order to avoid an overload.

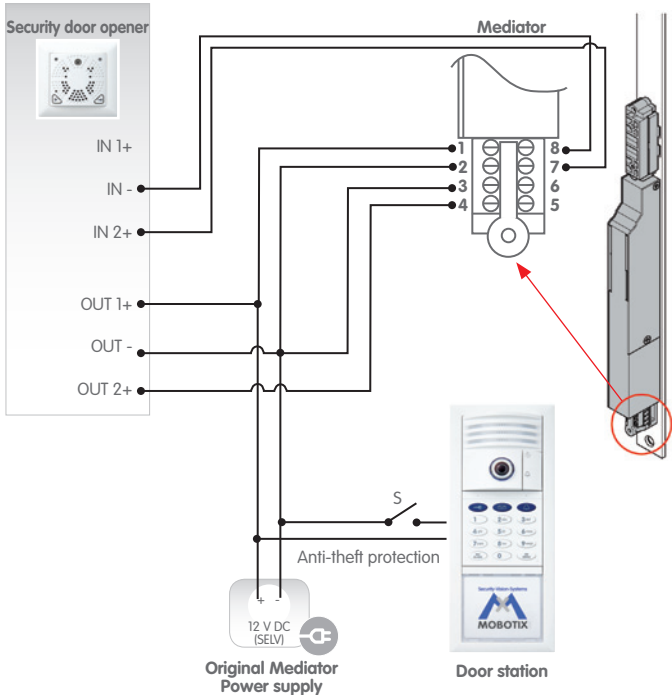

Mediator

Anti-theft protection connection cables are pre-fitted to the frame and can be extended (max. 50 m)

2.5.3 Mounting Instructions

Solid Concrete Or Stone Wall

MOBOTIX recommends using a deep in-wall socket (more space for cables). Standard in-wall sockets with a depth of 43 mm are not suitable for the security door opener.



Deep in-wall socket (ø 68 mm, 67 mm in depth)

Cavity Wall (e.g. Plasterboard, 7 mm to 35 mm)

Use the supplied 61 mm-deep cavity socket for the security door opener.



Cavity socket (ø 68 mm, 61 mm in depth)

Drill hole for cavity socket: ø 68 mm

Maximum MxBus cable length between security door opener and door station: 50 m

Note

MOBOTIX offers two orange cavity sockets of different depths (48 mm and 61 mm). The 61 mm-deep socket is designed for the security door opener, and the 48 mm-deep socket is intended for the Mx2wire indoor unit.

Determining The Installation Position

The security door opener must always be installed indoors protected from weather and moisture. If in doubt, use the normal installation conditions of a standard socket with no cover as a guide. The anti-theft protection connection cables pre-fitted to the frame of the outdoor station do not need to be extended if the security door opener is mounted on the same wall behind the outdoor station (next to the entrance door).

Installing The Security Door Opener

Preparing The In-Wall Socket (Solid Wall)

A in-wall socket must usually be fitted first. Make sure that the socket you use is as flush with the wall as possible to ensure proper installation. Also make sure that the socket and security door opener are aligned correctly.

After connecting the cables, there are **two ways** to attach the door opener board to the in-wall socket:

1. Secure the housing and board **directly to the socket** by fastening two small screws in the a and b positions (see fig.) However, this requires that the socket is properly aligned in the wall. Thanks to the elongated shape of the screw holes, it is possible to make small adjustments to the left and to the right when tightening the screws.

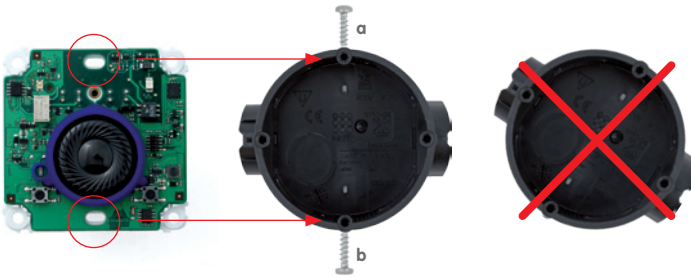

2. Use four or two Torx screws/screw anchors (diagonally opposite one another) to tightly screw the housing and board **to the wall**. We recommend using this procedure if the installed in-wall socket is not properly aligned or is not flush with the wall, or if the security door opener could easily be pulled out together with the in-wall socket.

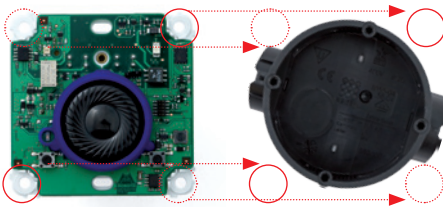

The in-wall socket used must be flush with the wall.



Hint: Use a cavity socket cutter (countersink hole cutter)

When the screws are tightened, the metal claws automatically pop out and clamp the socket to the cavity wall (made of wood or plasterboard, for example)

Preparing The Cavity Socket (Cavity Wall)

The security door opener can be mounted to a cavity wall (for example, plasterboard up to a thickness of 35 mm) using either the supplied cavity socket or an existing socket. Push the cavity socket into the prepared drill hole (68 mm) in the cavity wall and secure it by tightening the clamp screws. The metal claws automatically pop out and clamp the socket firmly.

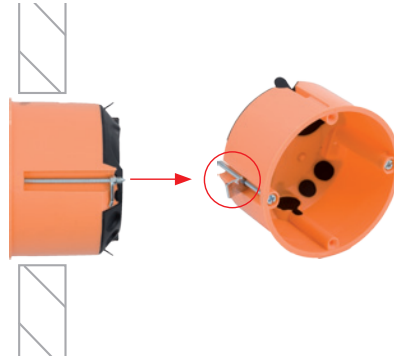

After connecting the cables, secure the housing and board directly to the cavity socket by fastening two small screws in the a and b positions (see fig.) This requires that the socket is properly installed in the wall.

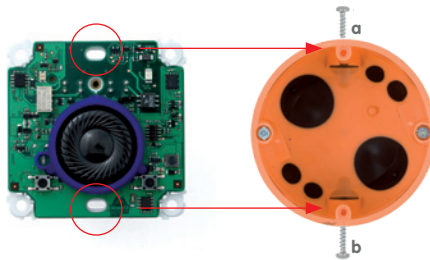

As in the case of the in-wall socket, you can also use four or two screws/screw anchors (diagonally opposite one another) to tightly screw the housing to the wall.

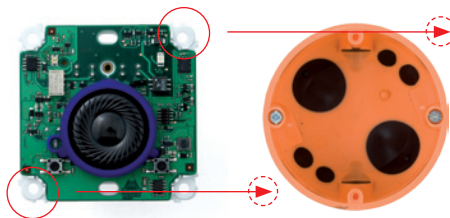

2.5.4 Installation Using Cavity Or In-Wall Socket

1. Prepare all the required **cabling and the cavity or in-wall socket**: See previous sections.

2. Remove the **battery pack**, connect the connector (A), guide the cable under the battery pack and replace the battery pack (B). The red LED indicates that the battery is low.

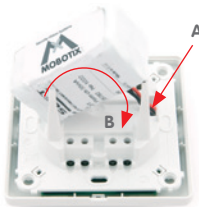

3. Screw on the **MxBus cable** (coming from the T24 door station):

- **Red wire to MX + terminal**
- **Blue wire to MX - terminal**

When extending the MxBus cable, make sure the polarity is correct (+/-).



Remove approximately 5 mm of insulation from all the cables used

4. **Screw on the anti-theft protection** (coming from the T24 door station):

- **First wire to OUT 1+ terminal**
- **Second wire to OUT - terminal**

The device still functions properly if the wires are swapped.



5. Screw on the electric **door opener** (coming from the door):

- **First wire to OUT 2+ terminal**
- **Second wire also to OUT - terminal**

The device still functions properly if the wires are swapped.



Important: See the connection options in Section 2.4.2

6. Screw on the 'door lock unlocked/locked' **door lock switch** (coming from the door):

- **First wire to IN 2+ terminal**
- **Second wire to IN - terminal**

The device still functions properly if the two wires used here (operating contact and changeover contact) are swapped.



7. Screw on the 'door opened/closed' **door contact** (reed switch) coming from the door:

- **First wire to IN 1+ terminal**
- **Second wire also to IN - terminal**

The device still functions properly if the two wires used here (operating contact and changeover contact) are swapped.



8. **Remove the front panel and frame:** In order to protect the board, the board is attached to the front panel and frame in the original packaging. To continue with the installation, however, you must first separate the housing and board from the panel and frame. Loosen the screw in the front panel and lift the panel forwards.

Now remove the attached frame from the board. Please note that you will need the stainless steel screw in the front panel again later.



9. **Insert the housing and circuit board into the socket:**

The two cable clamps on the rear of the housing are located at the top. When using a cavity socket, make sure you only use the stainless steel screws provided. Using different (larger) screws could damage the board.

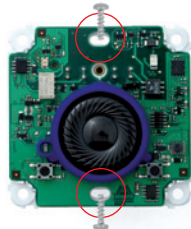

Caution

Electrical systems and equipment may only be set up, changed and maintained by a qualified electrician or under the management and supervision of a qualified electrician in accordance with electrotechnical regulations.



- Attach the frame:** Place the selected frame (concave, convex or flat) onto the board and press down gently until it automatically snaps into place. MOBOTIX is printed on the bottom of the frame.



- Insert the panel:** Hook the front panel onto the bottom of the frame, as shown in the figure, and then press it down.



- Screw the panel on tightly:** Secure the front panel using the panel's stainless steel screw.



Select the type of frame required

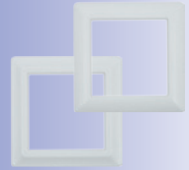

Notes

Make sure not to block the holes in the front panel (air circulation).

Following installation and initial operation, the security door opener batteries should be charged continuously for the first 12 hours. This takes place automatically via the PoE-powered T24 door station using the MxBus two-wire cable. During this time, the electric door opening function should not be used (except for a short functional test). This will maximize and extend the battery life of the high-quality NiMH battery (industry standard) to several years at normal use.

When replacing the batteries, always be sure to use original batteries. You can purchase these directly from MOBOTIX or your MOBOTIX partner.

When a battery is almost completely discharged, a functional test can only be carried out after the red LED has gone out (after approximately 15 minutes)



2.6 Installing The Mx2wire Indoor Unit

2.6.1 Overview Of Mx2wire Technology And Connectors

The Mx2wire technology that is optionally available with the T24 is used to connect the door station to the network via a simple two-wire cable such as the connection cable of an existing doorbell. An Mx2wire set always consists of two devices that communicate with one another: the Mx2wire info module in the outdoor station and the compact indoor unit.

In addition to data, power is also supplied via the two-wire cable to the Mx2wire info module, which (connected to the camera module via a patch cable) becomes a PoE injector for the entire T24 outdoor station and the security door opener.

Network Connection And Power Supply (Data And Power)

The Mx2wire indoor unit has an RJ45 port and is connected by patch cable to a switch or router, and thus also to the local network and the remote stations. In order for Mx2wire to power the T24, a voltage source is required. **There are two ways to achieve this:**

1. Power supply from a PoE+ switch (Class 4, IEEE 802.3at, max. 30 W)

Connection: via patch cable on the Mx2wire indoor unit.

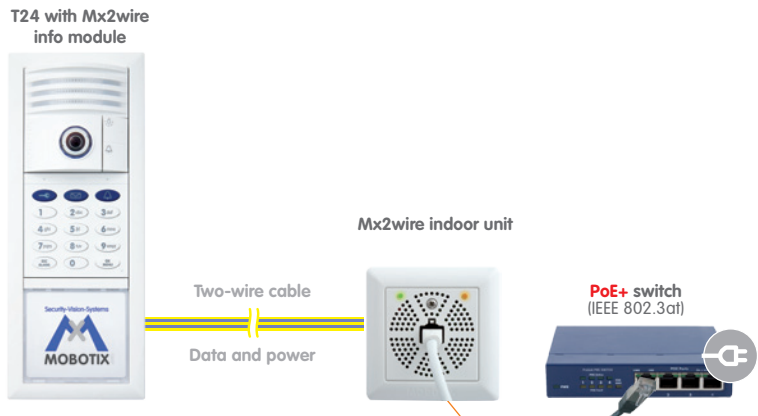

Advantage: The PoE+ switch directly connects the T24 remote stations as well, and depending on the number of available ports, it can also power further PoE devices (door stations, IP cameras).

2. Power supply from an external 48 V DC power supply unit

Connection: via two contact terminals either on the Mx2wire info module or on the indoor unit.

T24 with Mx2wire info module

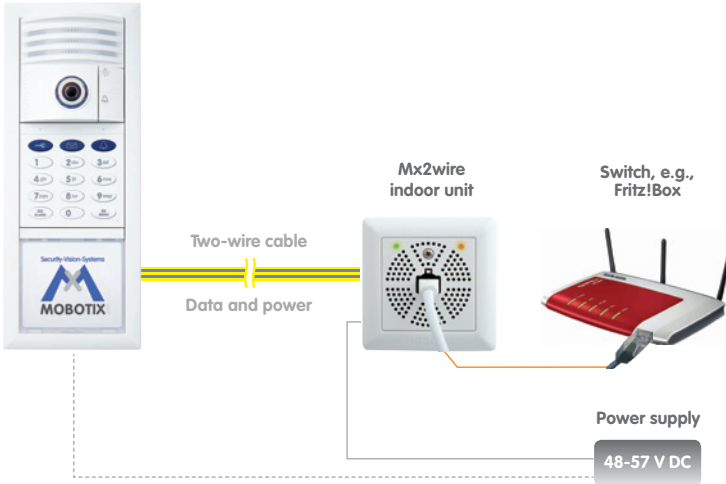

Advantage: flexible voltage connection option and direct connection of a router/switch for connecting remote stations (for example, Fritz!Box WLAN).

Extending The Range

A further advantage of Mx2wire is that it allows the range of a connection to be extended considerably using a two-wire cable up to 500 m long (a T24 connection using a network cable is limited to 100 m). For detailed technical information on the T24 version with Mx2wire technology, see Section 1.1.5.

2.6.2 Mounting Instructions

Mounting Options

In addition to an **on-wall installation** using the supplied surface-mounted socket, you can also choose to install Mx2wire using a **standard in-wall socket** or a **cavity socket (for wood or plasterboard, for example)**. Included in the delivery is a cavity socket of very high quality with soft rubber gaskets on the rear that need to be punctured by the two wires that feed in. The tight seal provided here is far superior to that offered by standard cavity sockets without this feature.



Surface-mounted socket



In-wall socket



Cavity socket

Please follow the installation instructions in Section 2.5.3. They also apply to the Mx2wire indoor unit.

Preparing And Testing The Two-Wire Cable

In general, Mx2wire is used with existing cables (bell wire). When cables have more than two wires, make sure (color coding) that the same cable pair is used for both Mx2wire units (see figure). **Approximately 5 mm of insulation** must be stripped from both ends of the two-wire cable.



Mx2wire info module

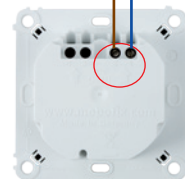

Mx2wire indoor unit

Cable with
wire-end sleeves
(for flexible cores)

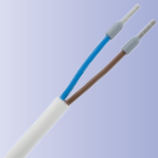

Prior to installation, test the cable connection to ensure that it is functioning properly (if necessary, draw up a test chart).

2.6.3 Installation Using Cavity Or In-Wall Socket

1. **Prepare the cavity or in-wall socket:** see Section 2.5.3
2. **Screw the two-wire cable to terminals 1 and 2:** The cable does not necessarily need to be attached to the terminal with the same number on both Mx2wire units. The device continues to function if connectors 1 and 2 are swapped.

Connectors 3 and 4 are only assigned if an external voltage source (48-57 V DC) is used.

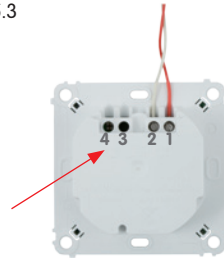

3. **Remove the Mx2wire front panel and frame:** In order to protect the Mx2wire circuit board, the board is attached to the front panel and frame in the original packaging. To continue with the installation, however, you must first separate the housing and board from the panel and frame. Loosen the screw in the front panel and lift the panel forwards.



The screw does not need to be removed completely from the front panel

Now remove the attached frame from the circuit board. Please note that you will need the stainless steel screw in the front panel again later.

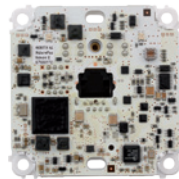

Safety Warning

Use this product in compliance with the applicable legal regulations. Electrical systems and equipment may only be set up, changed and maintained by a qualified electrician or under the management and supervision of a qualified electrician in accordance with electrotechnical regulations.



The board is attached directly to the socket using two screws (see left) or to the wall using the Torx screws

MOBOTIX printed at the bottom

4. **Insert the housing and circuit board into the socket:**

The two cable clamps on the rear of the housing are located at the top. For a cavity socket, make sure you only use the stainless steel screws provided. Using different (larger) screws could damage the circuit board.

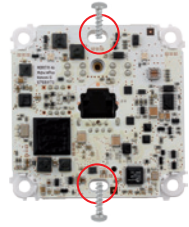

5. **Attach the frame:** Place the selected frame (concave, convex or flat) onto the board and press down gently until it automatically snaps into place. MOBOTIX is printed on the bottom of the frame.

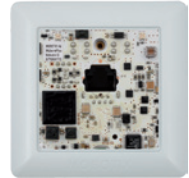

6. **Insert the panel:** Hook the front panel onto the frame, as shown in the figure, and then press it down.



7. **Screw the panel on tightly:** Secure the front panel using the panel's stainless steel screw.



2.6.4 Installation With Surface-Mounted Socket

1. **Prepare the surface-mounted socket:** Preparation: Please refer to the figure on the right and use the surface-mounted socket as a template to mark the drill holes. Make sure that the alignment and position of the socket in relation to the two-wire cable are correct (TOP/OBEN arrows).

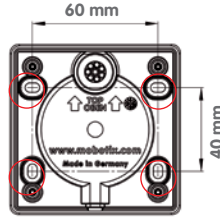

2. **Feed in the two-wire cable (plus optionally the 48 V connector) and screw on the surface-mounted socket:** Feed the two-wire cable through the opening provided that is sealed with a rubber plug. Use the 8-wire plug for multi-wire cables. You only require two of these wires for Mx2wire. The other two plugs with only one opening are ideally suited to insulated, two-wire cables of varying thickness. Now use the four Torx screws to securely fasten the surface-mounted socket to the screw anchors or directly to the (wooden) surface. Please ensure that you only use the existing four drill holes of the surface-mounted socket.



Supplied rubber plug for sealing the two-wire cable:

For cables with a 3-5 mm ϕ



For cables with a 5-7 mm ϕ



For cables with a maximum of eight wires



3. **Remove the Mx2wire front panel and frame:** In order to protect the Mx2wire circuit board, the board is attached to the front panel and frame in the original packaging. To continue with the installation, however, you must first separate the board and housing from the panel and frame. Loosen the screw in the front panel and lift the panel forwards.

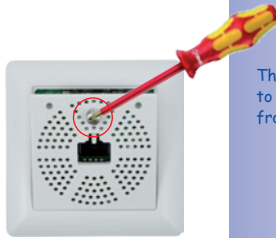

The screw does not need to be removed completely from the front panel

Now remove the attached frame from the circuit board. Please note that you will need the stainless steel screw in the front panel again later.

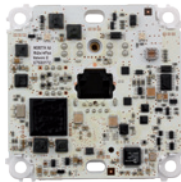

The device continues to function if connectors 1 and 2 are swapped



- Screw the two-wire cable to terminals 1 and 2:** The cable does not necessarily need to be attached to the terminal with the same number on both Mx2wire units. The device continues to function if connectors 1 and 2 are swapped.

Connectors 3 and 4 are only assigned if an external voltage source (48 V DC) is used.



- Insert the housing and circuit board into the surface-mounted socket:** The two cable clamps on the rear of the housing are located at the top. Attach the housing and board to the surface-mounted socket by fastening the four stainless steel screws in the four existing drill holes.

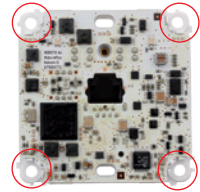

- Attach the frame:** Place the selected frame (concave, convex or flat) onto the board and press down gently until it automatically snaps into place. MOBOTIX is printed on the bottom of the frame.

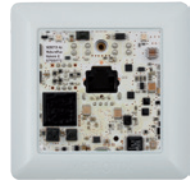

- Insert the panel:** Hook the front panel onto the frame, as shown in the figure, and then press it down.

First hook panel on underneath, then press down the top



- Screw the panel on tightly:** Secure the front panel using the panel's stainless steel screw.



2.6.5 Function Of Mx2wire Status LEDs

Each Mx2wire unit has two status LEDs (green and orange), which provide information on the current state of the PoE power supply and on the transfer of data. The LEDs can either light up continuously (ON) or they can blink (BLINK).

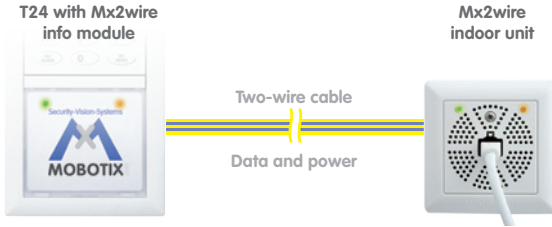

Green LED	Orange LED	Green LED	Orange LED
ON	ON	ON	ON
Power is supplied to the outdoor station	Network connection to the outdoor station has been established	Power is supplied to the indoor unit	Network connection to the switch has been established
BLINK	BLINK	BLINK	BLINK
never	Data is transferred to the outdoor station	Outdoor station is receiving power (is connected)	Data is transferred from the indoor unit

Note

The two **status LEDs (orange, green) in the outdoor station's Mx2wire info module** are only active for test purposes for the first 15 minutes after the power supply has been established. After the LEDs have gone out, they can be reactivated by interrupting the power supply for a short time.

2.7 Connecting External Devices To The Door Station

A power relay can be connected to the door station via an external power supply (max. 24 V AC/DC) for the purpose of switching different types of devices (for example, outside lights, garage doors, alarm systems, additional doorbells and so on). Connection is either via the MOBOTIX IO module (accessory: MX-OPT-IO1) or the keypad.

The T24 camera software is used to configure the switching of external devices and can be accessed via a standard web browser such as Internet Explorer. For additional information on this topic, see Part 2 of the System Manual.

2.7.1 Using The IO Module (MX-OPT-IO1)

Connect the IO module to the T24M camera module via MxBus, which connects it to the network. It has eight physical signal inputs that allow it to distinguish in AC operation between a pending full-wave and half-wave. This makes it possible to connect two switches to each signal input terminal so that 16 button inputs are made available. The inputs can be used for, e.g., bell buttons. The outputs can be used for external devices such as a doorbell, or for outdoor lights or garage door openers (via a power relay).



Installing the board and Ethernet connector: see Section 2.3.5

MX-OPTIO1 circuit diagram with 16 button inputs and 3 signal outputs (connected with a relay here)

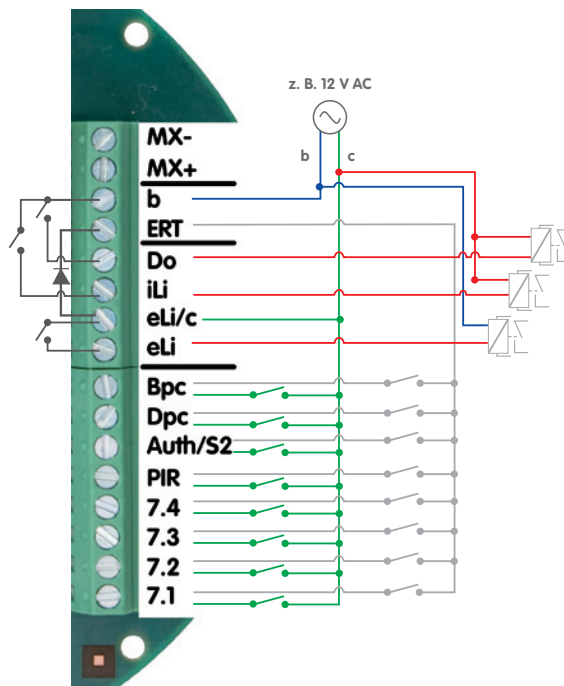

Terminal Connector Functions (External Devices And Siedle Vario)

In addition to general technical specifications for the signal inputs and outputs, the table also shows the precise layout of the 16-wire terminal connector when the external devices are modules from the Siedle Vario series (see Section 2.9).

Board	General Function	Siedle Vario Function	Comment
MX-	MxBUS-	MxBUS	Direct connection to camera module
MX+	MxBUS+		
b	Gnd	Ground	Reference potential
ERT	HW	Signal from eLi/c (half-wave rectified)	Floor call when c fits eLi/c
3 x signal outputs	Do	Max. switching voltage: 50 V AC, 50 V DC Max. current: 2 A Max. load: 60 W	Door opener
	ili		Internal lights of Siedle modules
	eLi/c		Control for external light (e.g., over the entrance door)
	eLi		Isolated relay (NO type)
8 x signal inputs	Bpc	Max. input voltage: 24 V AC, 24 V DC Min. input voltage: 5 V AC, 5 V DC Min. current: 2 mA	Door lock switch (Bolt Position Contact)
	Dpc		Door contact (Door Position Contact)
	Auth/S2		Transponder/Fingerprint
	PIR		PIR module/motion sensor
	7.4		Bell button 4
	7.3		Bell button 3
	7.2		Bell button 2
7.1	Bell button 1		

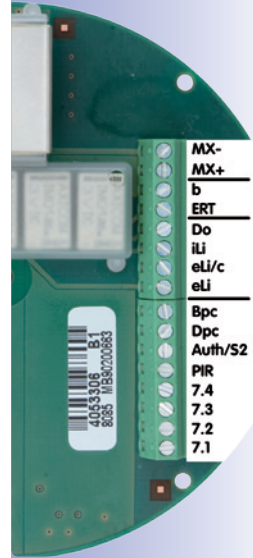

Example: Connecting A Lamp That Is Supplied With 230 V**Connect power relay (for lamp):**

- First wire to eli terminal
- Second wire to power supply
- Third wire to lamp
- Fourth wire to 230 V

Connect external power supply (for relay, e.g. 12 V AC):

- First wire to eli/c terminal
- Second wire to power relay

Connect lamp:

- First wire to power relay
- Second wire to 230 V

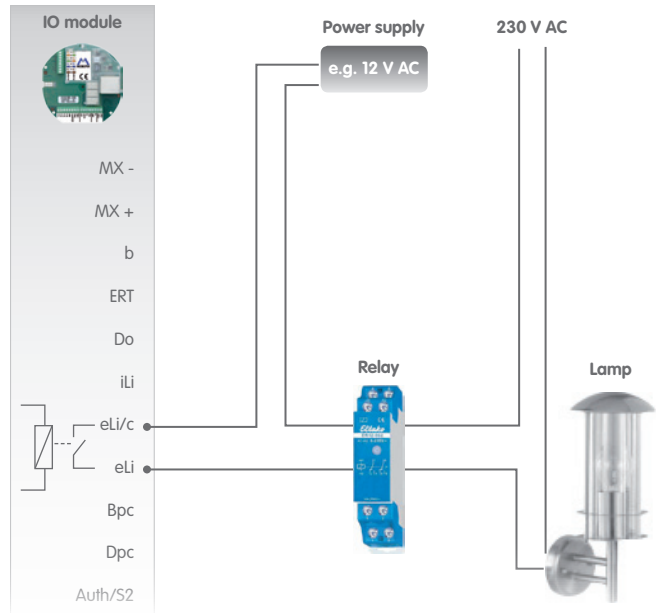
**Caution**

Electrical systems and equipment may only be set up, changed and maintained by a qualified electrician or under the management and supervision of a qualified electrician in accordance with electrotechnical regulations.



Example: Connecting Up To Four Bell Buttons

Connect bell buttons:

- First wire to terminals 7.1 to 7.4 (1 to 4 bell buttons)
- Second wire to power supply

Connect power supply:

- First wire to terminal b
- Second wire to bell buttons

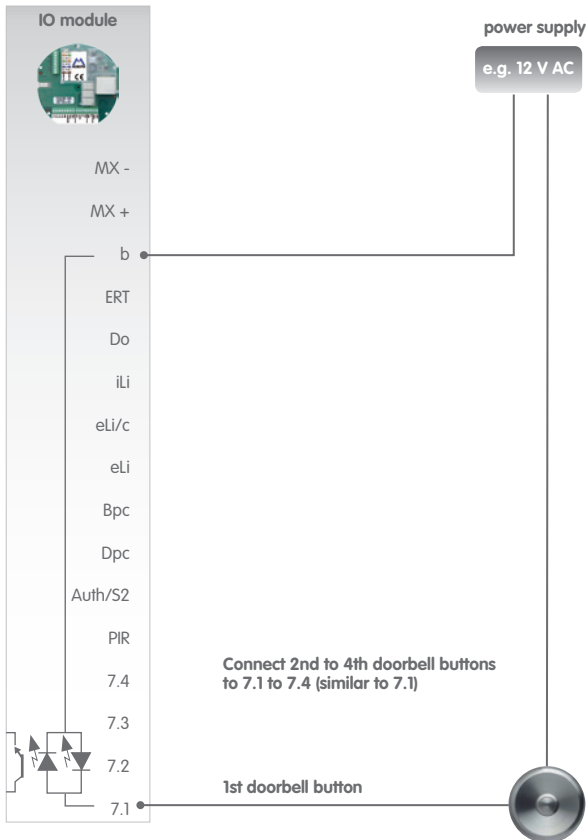

2.7.2 Using The Keypad Signal Outputs

If the T24 door station is used with the MOBOTIX security door opener and a standard door opener, all the keypad connectors apart from the MxBus connector remain unused (see Section 2.5.2, Version 1).

Example: Connecting A Lamp That Is Supplied With 230 V

Connect power relay (for lamp):

- First wire to COM terminal
- Second wire to OUT A terminal
- Third wire to lamp
- Fourth wire to 230 V

Connect external power supply (for relay, e.g. 12 V AC):

- First wire to OUT B terminal
- Second wire to COM terminal

Connect lamp:

- First wire to power relay
- Second wire to 230 V

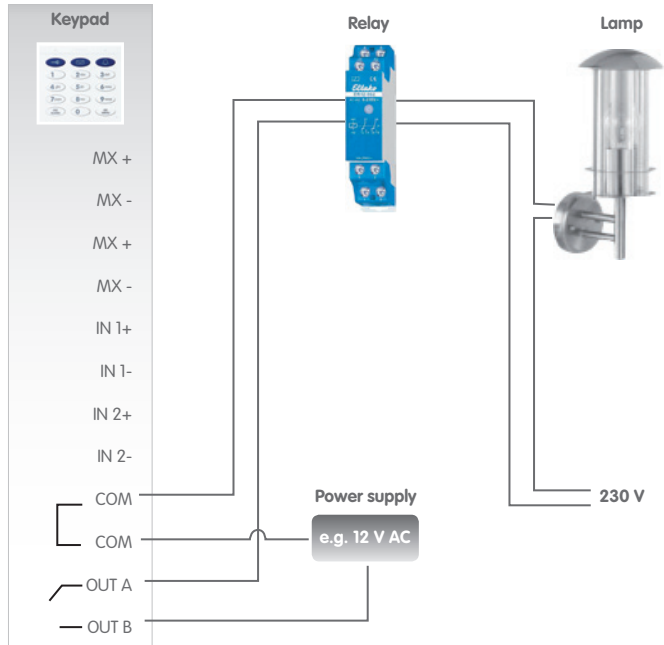

Example: Connecting Up To Two Bell Buttons

Connect first bell button:

- First wire to IN1+ terminal
- Second wire to IN1- terminal

Connect second bell button:

- First wire to IN2+ terminal
- Second wire to IN2- terminal

Note

The voltage required by the bell buttons (low voltage) is supplied by the keypad. No additional power supply is necessary.

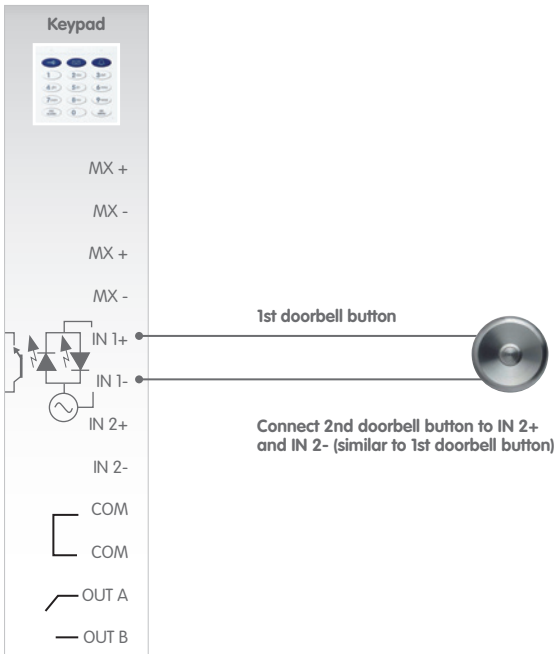

2.8 Finishing The Installation

2.8.1 Checking The Wiring And Activating The Anti-Theft Protection

After installing and connecting the door station, you will need to test the power supply to the individual modules and the security door opener.

Connect all the installed components (T24 outdoor station, security door opener, door opener/Mediator, door sensors, light and so on) and **connect the power supply** (switch on PoE switch/router and all power supply units used). The MOBOTIX IP Video Door Station starts up after the power supply is connected. The entire system starts up.

The buttons on the camera module light up for four seconds. Without pressing a button, wait until the lights go out after a few minutes and then light up again.



Notes

The blinking of the green LED on the keypad and security door opener indicates that data is communicated between the individual modules via Mx-Bus but the data communication is still unencrypted. After the system is started up (see Part 2 of the System Manual), the green LED lights up continuously (MxBus data communication is encrypted).

The LED on the keypad lights up red when the communication of data via MxBus is interrupted (for example, if the camera module stops working).

Checking The Wiring

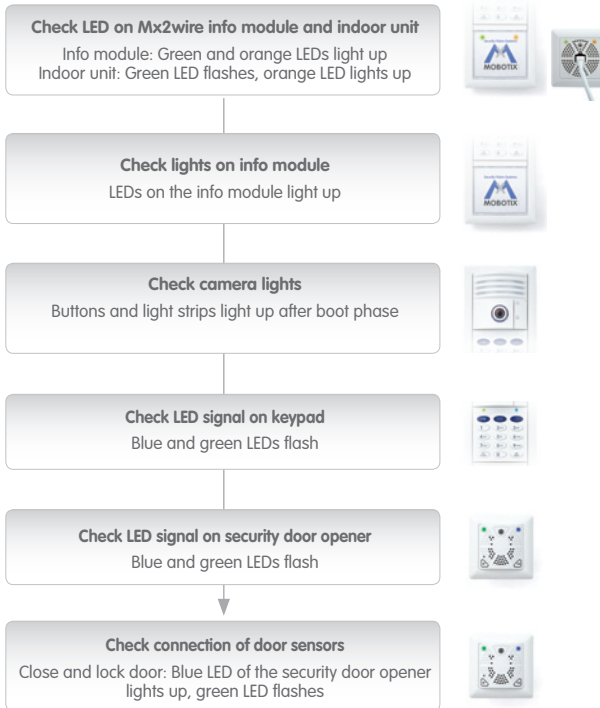

Test sequence from top to bottom; unavailable modules are skipped

When a battery is almost completely discharged, the red LED on the security door opener lights up first (for approximately 15 min.)

Activating Anti-Theft Protection

Test the anti-theft protection module by pressing and holding down the two buttons on the security door opener until the blue LED blinks. This deactivates the anti-theft protection in the frame for 90 seconds (see Section 2.4.6).

Use the special key to release the module above the mechanical anti-theft protection lock and turn the red button to the 'closed lock' symbol (see Section 2.3.7). Insert all the modules securely back into the frame. The modules can only be removed now after deactivating the anti-theft protection.



Before operating the door station, the batteries in the security door opener must be fully charged (maximum charging time: 12 hours). Finish the installation with Section 2.8.2. that follows.

2.8.2 Configuring The Security Door Opener

Before using the MOBOTIX security door opener, it is essential to configure the signal output option to be used (see Section 2.5.2).

Three Options Are Available

Option 1: Power Supply From Security Door Opener Battery (Self-Powered)

The door opener is supplied with a pulsed 12 V voltage (max. 10 W) from the battery. This state is signaled by a green LED in configuration mode. As this is the factory default setting, no further configuration is required for this connection option.

Option 2: Power Supply From External Power Supply Unit (Internal Relay Function)

The relay integrated into the security door opener switches an external voltage that powers the connected door opener. This is signaled by a red LED in configuration mode. Configuration is required here (see below).

Option 3: Self-Locking Mediator Door Lock Including UPS Via Battery Pack

A DC control signal is switched to the control input of the Mediator (special door opener that keeps the door permanently locked). This is signaled by a blue LED in configuration mode. Configuration is required here (see below).

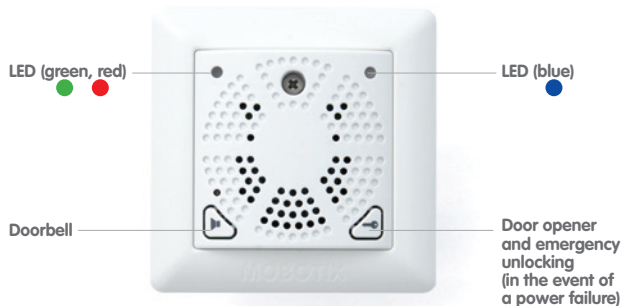

The signal output option is set on the security door opener in three steps as part of system startup.

Step 1: Press both buttons at the same time for 5 seconds (until double beep)

You are now in administration mode (red LED turns off shortly every 3 seconds).



Step 2: Press door opener button (right) to configure the signal output option

You can switch between signal output options 1 to 3 by pressing the right button repeatedly. The flashing pattern of the blue LED signals the currently selected setting.

- Blue flashing 1x every 3 seconds: Self-powered
- Blue flashing 2x every 3 seconds: Relay
- Blue flashing 3x every 3 seconds: Mediator



Step 3: Press both buttons at the same time for 5 seconds (until double beep)

The setting has been saved and you are exiting administration mode.



Notes

Test that the security door opener is functioning by pressing and holding the door opener button for 3 seconds. It should now be possible to open the door from the outside.

MX-OPT-IO1



Siedle info module
without Mx2wire
technology

The 36 mm (1.4")
protruding casing
of the spotlight
can slightly limit
the peripheral
area recorded
by the camera

2.9 Installation In The Siedle Vario System

2.9.1 Integrable Modules

When used together with the expanded MOBOTIX IO terminal board (MX-OPT-IO1), the hemispheric camera module of the T24 IP Video Door Station can also be integrated into a Siedle Vario system to work with the Siedle modules described here. Siedle products (modules, frames, network devices and so on) **cannot** be ordered from MOBOTIX.

In contrast to the MOBOTIX system, the Siedle Vario system has **no** tamper-proof door opener control.

Call Buttons TM 612-1, -2, -3, -4



The modules differ by the number of call buttons (4 max.). The label fields also have different sizes. The call buttons are offset from the illuminated label field and marked by an illuminated bell symbol. Polycarbonate front panel and transparent name labels that can be replaced from the front without tools. 99 x 99 mm (W x H).

Information IM 612-0



Individually printable, 91 x 84 mm LED-backlit (operating current: 25 mA) label field with insert for house number, company logo, business hours, etc. 99 x 99 mm (W x H).

LED Spot LEDS 600-0



For illuminating house numbers or call buttons, for example. Featuring an energy-saving and long-lasting LED bulb. IP54 weatherproof. The spotlight may not be positioned directly above the camera module. 99 x 99 x 36 mm (W x H x D).

Motion Sensor BMM 611-0

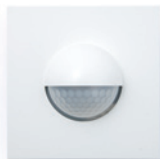

Detects, within a terminable range (max. horizontal detection angle: 180°), infrared rays as emitted by people and can activate the light, for example. The system contains a highly-sensitive infrared sensor. The horizontal detection area and the detection range may be adjusted as necessary. 99 x 99 x 25 mm (W x H x D).

The illumination switch function is supported directly by the T24 camera module

Electronic Key Reader ELM 611-01 (with EK 601-0 or EKC 601-0)



Contactless access control system with function LED. For use as a reader unit for (a maximum of 9) electronic keys (EK 601-0) or key cards (EKC 601-0) to open doors, gates, etc. Keys and cards do not require a battery. 99 x 99 mm (W x H).

The MOBOTIX keypad cannot be integrated into the metal Siedle frame, as this interferes with the RFID transmission technology

Fingerprint Reader FPM 611-01



In this system, the unique biometric features of the human finger are used to gain keyless access. Never worry about lost, misplaced, forgotten or stolen keys again. Several fingers may be read from each person. A maximum of five groups may be configured. With function LED. 99 x 99 x 17 mm (W x H x D).

Placeholder BM 611-0



Dummy module to cover empty slots, or placeholder for future expansions. 99 x 99 mm (W x H).

Note

Siedle Vario modules can also generally be mounted in the MOBOTIX T24 frame.

Transformer TR 602-01



For power supply to supported Siedle modules. Transformer in switchboard casing. Voltage: 230 V AC +/-10%, 50/60 Hz, output voltage: 12 V AC, output current: max. 2.5 A, protection: secondary short-circuit proof, protection class: IP 20, ambient temperature: 0°C to +40°C (32°F to 104°F).

Electronic Anti-Theft Protection DSC 602-0 With ZDS 601-0



Additional protection against unauthorized removal of modules. The module consists of the Anti-Theft Protection ZDS and the Controller DSC. The ZDS is fitted to the bar(s) of the installation frame and securely seals off access to the opening mechanism. The anti-theft protection controller is located in the distribution box, inaccessible from outside.

On-Wall Casing GA 612-XX With Installation Frame MR 611-XX

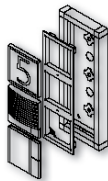

Siedle Vario on-wall casing made from extruded aluminum sheath with diecast zinc corner connectors and steel base plate for a maximum of six function modules. Completely powder-coated or painted, suitable for horizontal and vertical mounting. Matching installation frame included.

The integrated on-wall casing has a depth of 36.5 mm

In-Wall Casing GU 611-XX With Installation And Combination Frame MR/KR 611-XX

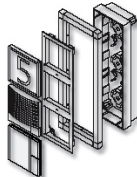

Siedle Vario casing for in-wall installation. The system includes a in-wall casing constructed from robust plastic for a maximum of six function modules, a matching installation frame made from diecast zinc and a combination frame including a circumferential seal made from extruded aluminum sheathing.

The combination frame located above the wall has a depth of 15 mm

Frame dimensions in mm

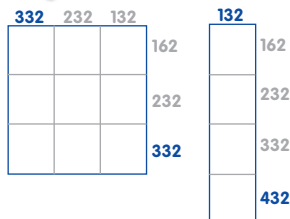

Frame dimensions (in mm) for one to four modules vertically (right), or up to three modules each in a grid horizontally and vertically (left).



2.9.2 Determining The Installation Position

Before installing the door station, you need to decide exactly where to install it. The system is generally installed so that the height from the ground to the upper edge of the frame is at least 1.60 m (5 ft 3 in). Depending on the frame size and orientation, the camera module **must always be placed in the top left** position in the Siedle Vario frame.

Always install the camera module in the upper left position

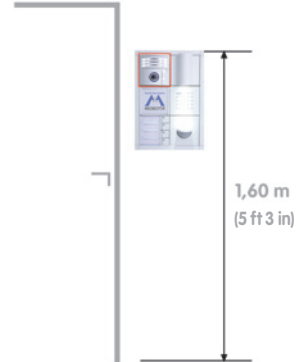

The system offers options for both **on-wall and in-wall installation**. Different installation sets are available for the two different options. The T24 camera module can be used universally for both installation options.

In addition to the (most popular) **vertical mounting option**, **horizontal mounting** of the Vario frame is also possible by rotating the camera module correspondingly when placing it into the installation frame.



Detailed instructions for in-wall and on-wall installation of the Vario system are included in the Siedle packaging.

2.9.3 Preparing Network And Power Connections

The door station requires the following basic cabling:

- **(A)** Ethernet cable from the PoE switch (or from a router with additional PoE power supply)
- **(B)** Two wires for powering the Siedle modules from the transformer in the electrical cabinet
- **(C)** Two wires for the anti-theft protection controller in the electrical cabinet (optional)
- **(D)** Two wires for the 230 V light relay
- **(E)** Cables to the external door opener, door contact and door lock switch

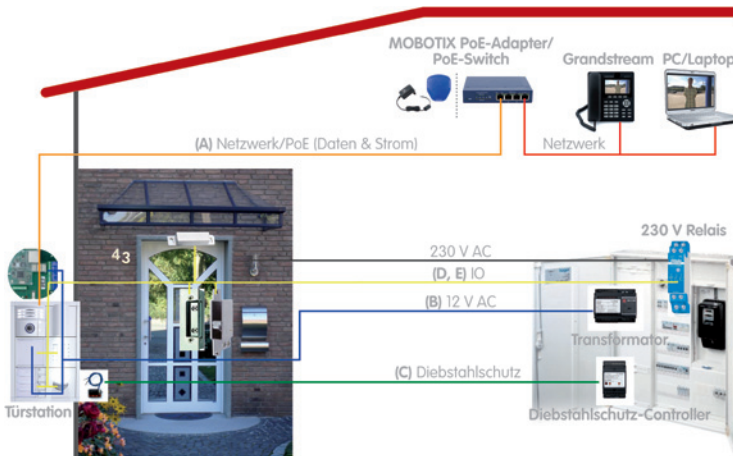

Safety Warning

Never connect or handle live cables (for example, a 240 V power supply) on your own; always have a trained electrician do the installation.



Recommendation For Cabling

As a specification for cable line A (network), MOBOTIX recommends using a category 5 (Cat 5) Ethernet installation cable or higher. For **cable lines B, C and D**, we recommend laying an **8- or 10-wire YSTY (telephone) cable with 0.8 mm core diameter**, even in the case of smaller installations, to make future expansion more convenient. As a rule, however, when maximum cable lengths are kept low, YSTY (telephone) cable with only a 0.6 mm core diameter may also be used. When laying the cable, ensure that sufficient length remains in reserve on the door station end for later extensions or for swapping modules (**lay a cable loop**). **All two-wire cables should be fed in through a in-wall socket on the inside of the door with sufficient space for cable reserves.** Both the network cable and other cables must be stripped at the ends.

Cat 7 cable is designed for 10 Gbit Ethernet



The optional MOBOTIX IO module connects the T24M to the Siedle Vario modules

2.9.4 IO Module And Terminal Connectors

MOBOTIX IO Module (MX-OPT-IO1)

The **central connection unit** for the door station is available from MOBOTIX as an accessory and **is required in the Siedle Vario system**:

- Bridge circuit from Ethernet installation cable to camera patch cable
- Connection to Siedle transformer (contact b and c)
- Connection to Siedle modules (for example, call buttons)
- Connection of a door opener
- Connection to the door and door lock switches
- Connection for external light

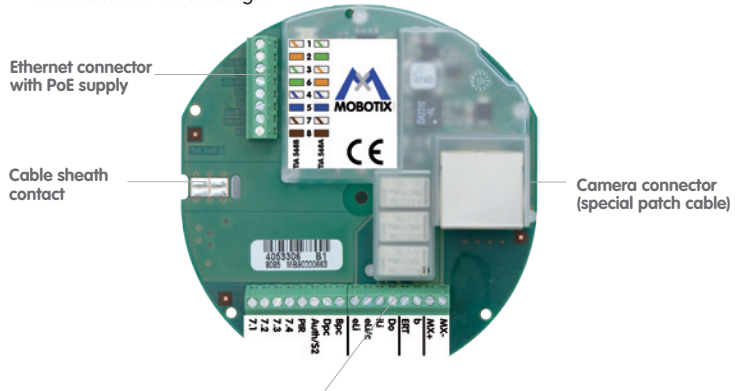

Terminal connector for: Siedle modules, power, door opener, door and door lock switches, floor call and external light

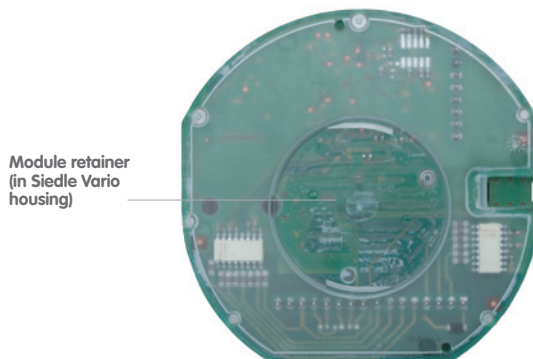

Mounting The IO Module And Terminal Connectors

After installing the on-wall or in-wall frame (note the "Top/Oben" indicator), fasten the individual module terminal connectors by positioning and simultaneously **rotating them by hand (from approx. 10 to 12 o'clock)**.

Fasten the IO module, which must always be placed behind the camera module, in the same manner. **To simplify installation, we recommend connecting the IO module to the network cable first (see the following section).**



Note: Connect the Ethernet cable to the terminal board before positioning

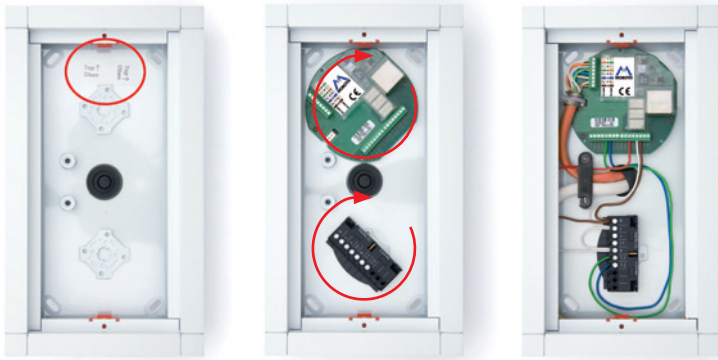

The figures show the **correct final position of the connector terminals and IO module** for both vertical and horizontal mounting of the door station.



Connecting The Network Cable To The IO Module

See Section 2.3.5.

2.9.5 Connections In The Door Station

Circuit Overview Diagram – Modules And Power Supply

For an external 12 V AC power supply, first run b and c in parallel from the Siedle transformer to the module terminal connectors, and finally b to b on the IO module.

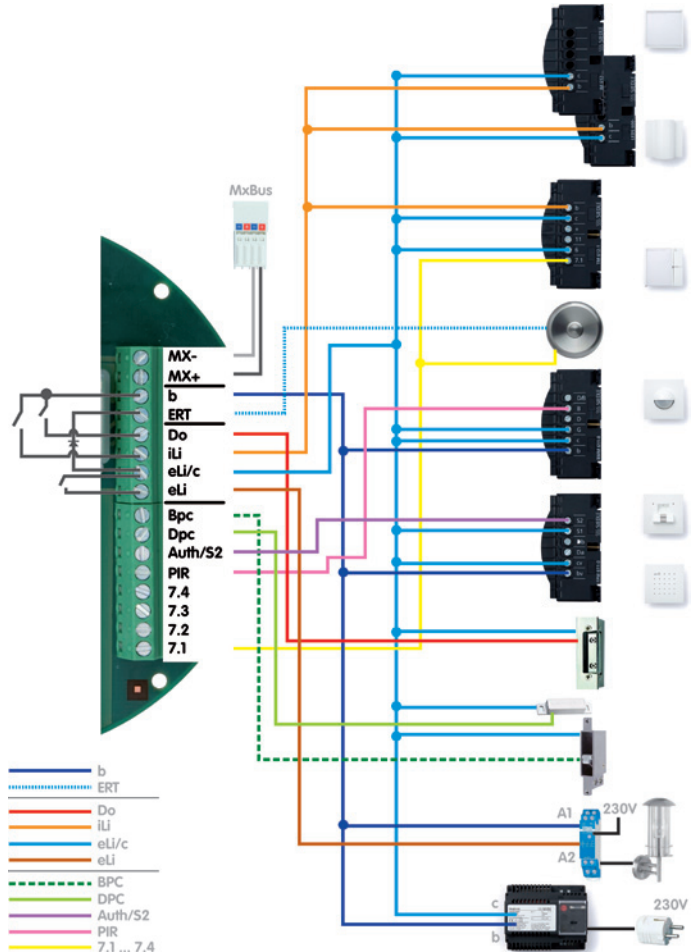

The b signal is not always switched to the **terminal marked as b** on the Siedle terminal connectors. For modules for which the internal light is active, the iLi signal must be connected to terminal b.

Siedle Bell Button Module (1 To 4)

Connect module terminals **c** and **6** (bell button base voltage) to **c**; connect module terminal **b** to IO module **iLi**; connect module terminals **7.1** to **7.4** to IO module **7.1** to **7.4**.

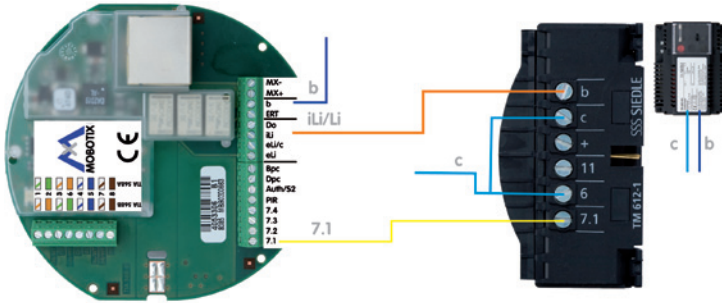

1 to 4 buttons

Board	Module
iLi	b
7.1	7.1
7.2	7.2
7.3	7.3
7.4	7.4

Siedle Fingerprint Module And Electronic Key

Connection for both modules is identical: Connect module terminal bv to **b**; connect module terminals cv and S1 to **c**; connect module terminal S2 to IO module **Auth/S2**.

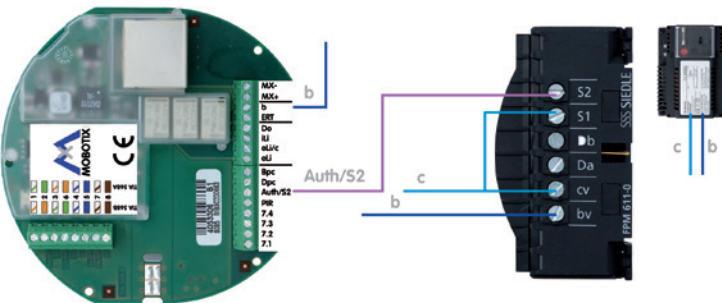

Fingerprint / Electronic Key



Board	Module
Auth/S2	S2

Siedle Motion Detector Module

The module here is used as a motion sensor and no longer as an illumination sensor, as the system uses the illumination sensor feature built into the camera.

Connect module terminal **b** to **b**; connect module terminals **c** and **G** (ground) to **c**; connect module terminal **B** (motion) to IO module **PIR**.

Motion Detector



Board	Module
PIR	B

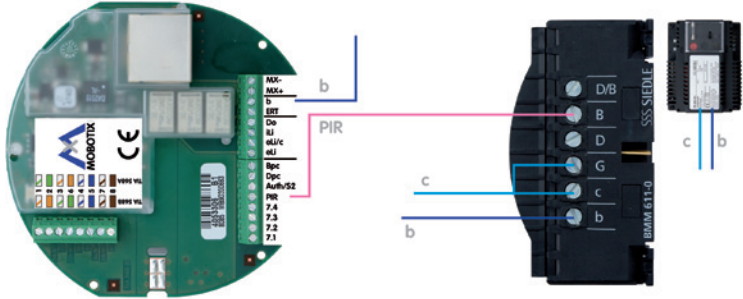

Siedle Info Module

For switchable internal module lighting (iLi), connect module terminal **c** to **c**; connect module terminal **b** to IO module **iLi**.

Info Module



Board	Module
iLi	b

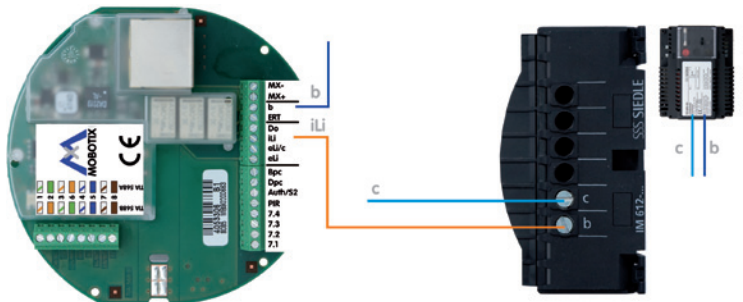

Siedle LED Spotlight

For switchable internal module lighting (iLi), connect module terminal c to c; connect module terminal b to IO module iLi.

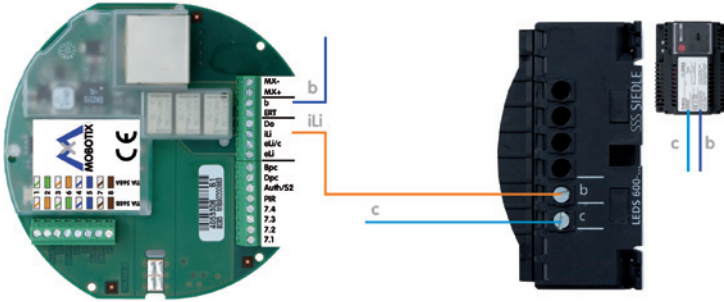

LED Spotlight

Board	Module
iLi	b

Note

The protruding casing of the spotlight can slightly limit the maximum area recorded by the camera.

External Light (Via 230 V Relay)

For switching an external lamp above the door station at the entrance, for example, you need a connection from c to the IO module (isolated output): connect relay input A1 to b; connect IO module eLi/c to c (control voltage); connect relay input A2 to IO module eLi.

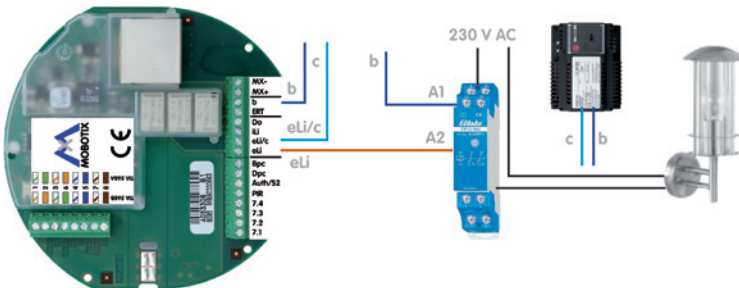

Board	Transformer/signal
eLi/c	c

Board	Relay
eLi	A2

Relay	Transformer/signal
A1	b

Floor Call

The integrated floor call function presents a convenient option to assign directly at the apartment door each of the bell buttons at the building door to an additional bell button (floor call button).

To connect the floor call buttons, first connect eLi/c to c; connect one contact of the floor call button with ERT – in order to reloop ERT from unit to unit – and the other contact with the terminal belonging to the apartment, 7.1, 7.2, 7.3 or 7.4.

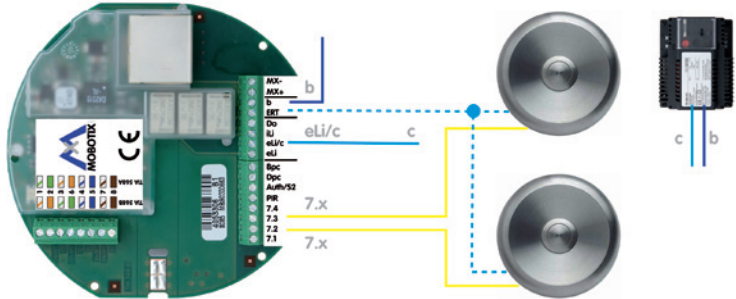

Note

If the IO module relay between eLi/c and eLi is to be isolated and simultaneously used for the floor call function, an external accessories diode (for example, Siedle ZD 061-10) will be needed: c is connected to the anode of the diode, while the cathode is connected to the floor call button (diode conduction direction from c to the floor call buttons); the other contact of the floor call button is connected to the terminal associated with the apartment, 7.1, 7.2, 7.3 or 7.4.

Door Opener

Connect the electromagnetic door-switch opener to IO module Do; connect second connector to c.

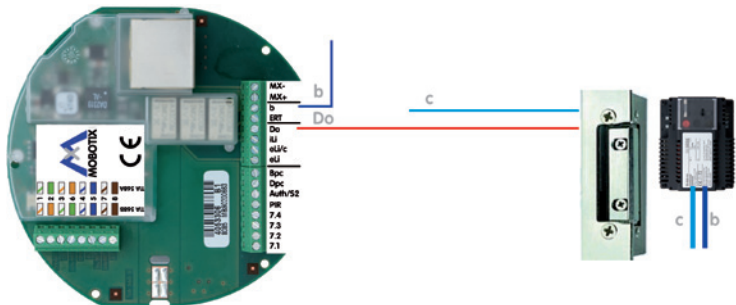

Board	Module
7.4	Bell button 4
7.3	Bell button 3
7.2	Bell button 2
7.1	Bell button 1
ERT (optional)	Bell button x

Board	Transformer/signal
eLi/c	c

Board	Module
Do	Door opener

Door Contact And Door Lock Switch

Connect both with one connection each to c; connect the second connector of the door contact to IO module Dpc (Door Position Contact); connect the second connector of the door lock switch to IO module Bpc (Bolt Position Contact).

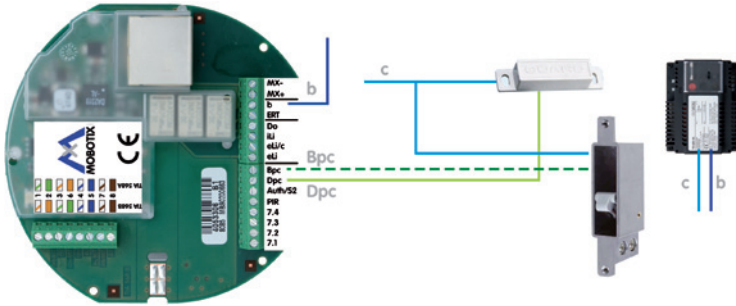

Board	Module
Dpc	Door contact

Board	Module
Bpc	Door lock switch

Note

The contacts can generally also be installed in existing doors. To do so, use a long drill bit to drill a conduit in the door frame leading directly to an in-wall socket on the wall facing the door inside the building, then lay a cable from here to the door station.

Siedle Anti-Theft Protection

The separately available Siedle Anti-Theft Protection module (DSC 602-0 with ZDS 601-0) provides additional protection by electromagnetically locking the installation frame so that the individual modules can no longer be mechanically removed (using the supplied Siedle key) from the door station.

The lock (ZDS 601-0) mounted in the installation frame is connected to the associated controller (DSC 602-0) in the electrical cabinet. Anti-theft protection can only be activated or deactivated using this controller.

Installation instructions are included in the Siedle Anti-Theft Protection package.



2.9.6 Connecting, Securing And Removing Modules

Connecting And Securing

For detailed installation instructions for Siedle products, see the documents provided by Siedle directly.

1. **Mount the Siedle installation frame:** Position the Siedle installation frame and snap it into place.

Ensure that the two-wire cable with the **MxBus push terminal is routed through** and not jammed. The MxBus cable must be secured to both of the MxBus terminals on the terminal board (red wire to +, blue wire to -). For more information, see the circuit overview diagram in the last section.

The MxBus cable must be secured to both of the MxBus terminals on the terminal board (red wire to +, blue wire to a -). For more information, see the circuit overview diagram in the last section.



2. **Connect cable:** Connect the camera patch cable to the RJ45 connector on the terminal board.

Connect the **MxBus push terminal** with the camera module.

Ensure that the camera patch cable is positioned under the middle bar of the brass installation frame.



3. **Mount the camera module:** Place the camera module onto the installation frame from above and snap into place.



4. **Mount the Siedle modules: Connect the modules** with the associated terminal connector. Place modules such as the camera module onto the installation frame from above.



Removing

For detailed installation instructions for Siedle products, see the documents provided by Siedle directly.

1. **Deactivating Siedle anti-theft protection:** If the anti-theft protection accessory has been installed, it must first be switched off at the controller before the modules may be removed.
2. **Removing the camera module and Siedle modules:** Take the special key, which was included with the Siedle installation frame.

Insert the key into the small opening between the modules and release the modules from the installation frame by pushing the key in.



The special Siedle key is included with the installation frame delivery kit



MOBOTIX GLOSSARY

Bonjour

Also known as Zeroconf network. Bonjour enables automatic identification of computers, devices and services in IP networks. Bonjour also enables the automatic identification of devices among one another, without the user having to enter IP addresses or configure the DNS server. Bonjour was developed by Apple Computer Inc.

CCTV

Abbreviation for Closed Circuit Television. A television system in which the analog video signal is only transmitted to monitors in a specific environment (for example, within a building). The term CCTV is often used for video surveillance systems.

CIF, 2CIF, 4CIF (acc. to PAL)

Common Intermediate Format: CIF = 1/4 TV image with 288 lines and 352 pixels (0.1 megapixel); 2CIF = 1/2 TV image, also with 288 lines but 704 pixels (0.2 megapixel); 4CIF = quality of a conventional TV image with 576 lines and 704 pixels (0.4 megapixel).

CMOS Sensor

Abbreviation for Complementary Metal Oxide Semiconductor sensor. Sensor for energy-efficient digitization of image information. CMOS sensors are used as image sensors in digital cameras.

DHCP

Abbreviation for Dynamic Host Configuration Protocol. Allows a server to automatically assign devices in the network with the appropriate configuration (including the IP address, DNS server and gateway), as opposed to static IP addresses on the individual network devices.

DNS

Abbreviation for Domain Name Service. Allows the domain names of servers on the Internet (for example, www.mobotix.com) to be linked ("resolved") to their corresponding IP addresses (for example, 212.89.150.84).

Door Opener

The door opener (also known as e-opener, electric door opener) is installed complementary to the door lock. The door opener has a closing latch, which connects with the door closer and keeps the door locked until contact is made from the interior of the building. This contact raises the lock of the door opener latch, and the latch is unlocked electromagnetically. The door at the exterior entrance can now be opened. As soon as the door is fully closed again, the latch in the door opener is automatically blocked. The door is locked once again.

The approval to open the door can be indicated by various means (e.g., dialing tone). Door openers are primarily intended for daytime use. At night, the door in question should be locked using the bolt lock.

DynDNS

Abbreviation for Dynamic DNS (or DDNS, Dynamic Domain Name Service). Similar to DNS, this links domain names (e.g. mydomain.com) with IP addresses, whereby the IP addresses may change at any time. This service provides a convenient method to access your MOBOTIX cameras from home or work if the camera Internet connection is not through a router that assigns a fixed IP address, but instead over a DSL connection with a dynamically-assigned IP address from the provider. A well-known provider of this (free-of-charge) service is www.dyndns.org.

DVR

Abbreviation for Digital Video Recorder.

Ethernet

Ethernet is the most widely-used LAN technology. Twisted-wire pairs with special quality features are normally used for Ethernet LANs. The most widely-used Ethernet systems are 10BASE-T and 100BASE-T10, which enable data transfer rates of up to 10 Mbps and 100 Mbps.

Factory Defaults

These are the settings with which a device leaves the manufacturer's factory when it is shipped. If it is necessary to restore a device to its factory defaults, all the settings changed by the user will usually be lost.

fps

Abbreviation for frames-per-second. See Frame rate.

Frame Rate

The frame rate specifies how many frames per second (fps) are generated and sent by the camera. 16 fps and higher is perceived by the human eye as a fluid video sequence.

G.711

The process or processes by which analog audio signals are encoded and decoded. This codec (= enCOder-DECOder) is used in classic telephone systems and in IP telephony.

H.264

The processes by which the video image is coded, compressed and decoded.

HDTV

Abbreviation for High Definition TV, which has a much higher resolution than conventional TV signals.

HiRes

Abbreviation for High Resolution. Refers to high-resolution images (above 1 megapixel).

Illumination

In general, a camera does not require additional lighting for use in daylight. However, some basic rules must be observed for use in the dark or under artificial light. A suitable light source or supporting lighting must be selected depending on whether a general overview is required or whether people or objects have to be accurately identified.

Image Compression

Image compression reduces the file size of an image. This is particularly important when transferring and saving files.

IP Address

The IP address refers to the address of a computer or device in an IP network. Using IP addresses, all computer/devices connected to the network can be identified, and data can be transferred in both directions. Every IP address must be unique to the network in question in order to prevent conflicts. IP addresses can be assigned as fixed addresses so that they are never changed, or they can be allocated dynamically (and automatically) via DHCP.

Every IP address consists of four groups (or quads) of decimal digits, which are separated from one another by full points, such as 130.5.5.25. Each quad within the address provides different information. One quad represents the network number or address; another the address of the local computer.

IP Camera

An IP camera is a special type of video camera. This kind of camera differs from other video cameras in that it forwards its images via IP networks. Network cameras also include a computer in addition to the actual camera components. The integrated computer deals with compressing the image data and ensures that data is sent via the network. It mainly consists of a CPU, Flash memory and DRAM memory. The network camera software enables the device to appear in the network as a web server, FTP server, as well as an FTP client or e-mail client.

IP Network

Data network based on the Internet protocol (TCP/IP).

JPEG

Abbreviation for Joint Photographic Experts Group, responsible for the development of the JPEG standard method for image compression. JPEG is the most common lossy image format for photos on the Internet. Loss in image quality is barely noticeable at compression rates ranging from 60% to 99%.

LAN (Local Area Network)

A LAN consists of a series of computers and associated devices that use the same communication resources in a restricted geographical area.

LED

Abbreviation for Light Emitting Diode; an electronic semiconductor component built into MOBOTIX cameras and add-on modules that emits light when a current flows through the component in the correct direction.

Lux

The unit for measuring the quantity of light.

Mbps (megabits per second)

Unit for measuring the bit rate, i.e., the speed at which bits are transferred to a particular location. Network speed is usually stated in Mbps. LANs are often operated at 10 Mbps or 100 Mbps. See also bit rate.

Mediator Lock

A self-locking door lock with an electrical door opener. Can also be retrofitted on existing doors. People can exit through the door at any time, despite the fact that the door is constantly locked. Exiting is possible in the case of danger, during normal operations, and without a key (safeguarding of escape routes).

Megapixel

Images that have more than 1 million pixels.

MicroSD Card

SD Memory Card (Secure Digital Memory Card). A digital storage medium based on Flash storage modules.

Motion Detection

Detection and identification of movements within a particular area. MOBOTIX cameras use algorithmic methods to detect changes from image to image in predefined areas, while taking into account preset conditions. If a camera detects a movement, it signals an event and triggers an alarm.

MPEG

Motion Pictures Expert Group. Standard for compressing and saving image and video data, resulting in quality loss. Originally created for playing entertainment content on computers, MPEG concentrates on displaying still image material and compromises the quality of moving image material in order to increase the transmission speed.

MxControlCenter

MOBOTIX video management software for professional control of medium and large-sized camera networks.

MxEasy

Free of charge MOBOTIX video management software for small and compact camera networks of up to 16 cameras/door stations.

MxPEG

Method developed by MOBOTIX to compress and store image and video data with low network load and high image quality. The MxPEG ActiveX control element allows video and audio data from MOBOTIX cameras to be displayed in other applications (including Internet Explorer).

Network

A group of end devices, such as computers, that are connected via various cables and share access to data and devices such as printers and IP cameras.

Opening Contact

On moveable building elements (window, door), a magnetic contact (Reed contact) is attached to the fixed part, and a magnet is attached to the moveable part. When the door is closed, the magnet is located in direct proximity to the contact and keeps it closed. When the door is opened, the magnet is removed and the contact opens.

PIR Sensor

Passive infrared sensor for motion detection.

Pixel (Picture Element)

One of the many tiny image dots that make up a digital image. Each pixel determines through its color and intensity a tiny part of the overall image.

Perimeter Protection

Perimeter protection (outdoor protection) serves to protect an object through measures in its surroundings or in the surrounding free space, usually up to and including the site boundary line. This includes mechanical/building measures (perimeter security), electronic/detection measures, and/or organizational/staffing measures (perimeter surveillance).

PoE (Power over Ethernet)

Power-over-Ethernet enables power to be supplied to a network device using the same cable that is used for connection to the network. This is particularly beneficial in the case of IP and remote surveillance in places where laying a power cable from the nearest outlet would be too costly or time-consuming.

Product Liability

Under the German Product Liability Act, the manufacturer or retailer is liable for the product that they have brought to market. Claims are only possible when the product is used in accordance with its intended use and there is no evidence of misuse. The technical specifications and information described in the T24 System Manual must be observed. Otherwise, the manufacturer is released from their product liability in accordance with the German Product Liability Act.

PTZ

Abbreviation for Pan/Tilt/Zoom. Refers to the movement of a video camera to the left and right, up and down, and to the camera's ability to enlarge an image.

Resolution

Indicates the number of pixels used to produce an image. The more pixels an image has, the more recognizable the details remain when the image is enlarged. The resolution is expressed as the number of pixel columns by pixel rows or as a total number of pixels. A VGA image has 640 columns and 480 rows (640 x 480), which equals 307,200 pixels or approximately 0.3 megapixels. The T24 has 3.1 megapixels.

RFID (Radio Frequency Identification)

RFID enables data to be transferred contact-free and out of sight using radio waves. An RFID system infrastructure comprises a transponder, a transceiver device and an IT system operating in the background.

The transponder, a tiny computer chip with an antenna, is at the heart of this technology. It is integrated into a carrier object, for example, an adhesive label or a plastic card. The chip is normally used to store a numerical code. This encrypts information that is stored in a database. As a result, every object with an RFID transponder has a unique identity.

When close to the antenna of a reading device, passive transponders that do not have their own power supply are powered by means of inductive or capacitive coupling. The data is also read out by means of coupling in the inductive field.

RoHS

Abbreviation for Restriction of Hazardous Substances Directive; refers to EC Directive 2002/95/EC, which prohibits the use of certain hazardous substances when manufacturing products and components. The goal of this directive is to prevent these substances from harming the environment when the products are disposed of later.

Router

A device that determines the next network node to which a package is to be forwarded on its way to the target participant. The router creates or maintains a special routing table, which provides information on how particular destinations can be best reached. Routers are sometimes integrated into network switches.

Search

Monitoring of recordings or searching for a particular event.

Server

Generally speaking, a server is a computer program that provides services for other programs, either on the same computer or on a different one. A computer on which a server program is running is often also known as a server. In practice, the server computer can run a very large number of server and client programs. The program that provides the requested HTML pages or files for the client (browser) is known as a web server.

(Signal) Inputs and Outputs

Using the digital inputs and outputs on the T24, any device that can switch between an open and closed circuit can be connected.

Signatures for Video Images

Digital video images can be transferred, as well as jointly edited and deleted, via data networks. In order to prevent unwanted manipulation and to ensure the validity of digital video sequences in the case of investigations, it is necessary to faultlessly identify the time of recording, the origin of the images (camera ID) and the authenticity of the images (no changes after recording). This is only possible if the images are labeled using

cryptographic methods. In the case of digital video cameras with integrated analysis, it is possible to integrate a unique camera ID and the precise time of day, and to encrypt this data so that any change to or manipulation of the video sequence can be traced during later analysis.

SIP

Session Initiation Protocol. Network protocol for setting up, controlling and terminating a communication connection via a computer network. SIP is frequently used in conjunction with IP telephony.

Structured Cabling

Structured cabling is a standardized schematic diagram for the cabling of different services (voice or data). It facilitates the extension of a data network to allow for the subsequent installation of new components, and therefore supports current and future communication systems. This is generally based on a valid structure that contains reserves and can also be used independently of a particular application. Structured cabling must be failsafe to ensure data protection and data security.

Subnet, Subnet Mask

A subnet is an identifiable separate part of an organization's network. A subnet often represents all the computers within a geographical location, building or LAN. By dividing a network into subnets, every subnet can be connected to the Internet using the same shared network address.

The subnet mask is that part of the IP address that is used by a network router to identify the subnet to which a data package is to be transferred. The subnet mask saves the router from having to process the entire 32 bits of the IP address; this way, it can very quickly process only the bits indicated by the mask.

Switch

Hardware used to connect multiple network devices (computers, cameras, printers, etc.) within a network. A PoE switch can also supply the (door) cameras with power over an Ethernet cable. Certain switches also function as routers.

Transponder

A transponder is a device used for wireless communication (for example, as a key fob or a check card). The device detects the incoming signal and automatically responds to it or forwards it. The term "transponder" is made up of the terms "transmitter" and "responder." Passive transponders do not require their own power source, but they only work over short distances.

UPS

Uninterruptible Power Supply. Refers to devices that temporarily continue to supply power in the event of a sudden power failure. These devices usually operate using a battery. UPS is installed on the power lines of devices and systems in order to protect them in the event of a power failure.

USB (Universal Serial Bus)

Plug-and-play interface between a computer and peripheral devices (scanners, printers, etc.).

Video Voice System

The video voice system is usually able to capture outdoor areas visually. The system has an intercom or duplex intercom option as well as an electrical door opening device. The basic hardware consists of the door station (exterior), monitoring station (interior) and control center.

In the broadest sense, it is an access control system that can be extended to include several door and/or monitoring stations, but always requires human intervention. It is intended for use in visitor control, predominantly for entrances and gateways in private areas and medium-sized business premises. The most important usage options are residential buildings, apartment buildings, offices and business premises, as well as other entrance and gateway areas that are not visible or are difficult to see from inside (personal security checks for public authorities, institutions and for other exposed areas, e.g., EDPI).

VoIP

Voice over IP. Telephony using computer networks.

Wizard

Refers to a software component that helps the user to install or set up a particular program, and guides the user through the configuration process by means of simple questions.

WLAN (Wireless LAN)

A wireless LAN that transfers data over the mobile radio network. The end user is wirelessly connected to the network, while data transfer across the network's main structure usually remains cable-based.

You will find declarations of conformity for all further T24 modules on the MOBOTIX website under www.mobotix.com > Support

T24M Hemispheric Camera

Konformitätserklärung Declaration of Conformity Déclaration de conformité

Hersteller: Manufacturer: Fabricant :	MOBOTIX AG
Produkt: Product: Produit :	Netzwerk-Kamera Network camera Caméra de réseau
Typ: Type: Type :	T24M (inkl. evtl. verbaubtem IO-Modul oder Ethernet-Anschlussplatine) (incl. optionally installed IO module or Ethernet connector board) (avec module IO ou platine de connexion Ethernet installée optionnellement)

Bei bestimmungsgemäßer Verwendung erfüllt das bezeichnete Produkt die Bestimmungen der im Folgenden aufgeführten Richtlinien:
The product identified above complies with the essential requirements of the relevant standard, when used for its intended purpose:
Le produit désigné ci-dessus est conforme aux exigences fondamentales des normes s'y rapportant :

EMV-Richtlinie EMC directive Directive CEM	2004/108/EG
---	-------------

Angewendete harmonisierte Normen: Harmonised standards applied: Normes harmonisées :	EN 55022:2006; CISPR 22:2005+A1 EN 55024:1998+A1:2001+A2:2003 EN 50121-4:2007 EN 61000-6-1:2007 EN 61000-6-2:2005
---	---

Weitere angewendete Normen: Other harmonised standards applied: Autres normes harmonisées :	CFR 47, FCC Part 15B C-Tick AS/NZS 3548
--	--

Anschrift: Address: Adresse :	MOBOTIX AG Kaiserstrasse 67722 Langmeil Germany
--	--

+ TK-Nr. / Phone number / N° de communication :

Fon:	+49 6302 9816-0
Fax:	+49 6302 9816-190
E-Mail:	info@mobotix.com



Langmeil, 01.03.2010
Ort, Datum
Place & date of issue (day/month/year)
Lieu et date

Dr. Ralf Hinkel
Vorstand/CEO, MOBOTIX AG

Name und Unterschrift
Name and signature

Nom et signature

MOBOTIX - The HiRes Video Company



**To demonstrate our confidence in the quality of our products,
MOBOTIX cameras were used to capture all the images that
appear in this manual.**

Manufacturer

MOBOTIX AG
Kaiserstrasse
67722 Langmeil, Germany
Germany

Tel: +49 6302 9816-103
Fax: +49 6302 9816-190

<http://www.mobotix.com>
sales@mobotix.com

Executive Board

Dr. Ralf Hinkel
Registration Office: Kaiserslautern Local Court
Registration Number: HRB 3724

Tax Code: 44/676/0700/4
Tax Office: Worms-Kirchheimbolanden

VAT ID:
DE202203501

You can find the latest version of this document at www.mobotix.com under **Support**.



Technical specifications subject to change without notice!

© **MOBOTIX AG** • **Security-Vision-Systems** • **Made in Germany**

www.mobotix.com • sales@mobotix.com



Part 1: System Overview And Installation

Installation and cabling
(for the **installer**)

Part 2: Start-Up And Configuration

Software and network
(for the system administrator)

Part 3: Operating Manual

Modules and remote stations
(for the user)

HiRes

3 Megapixel

2048 x 1536
Software zoom

Skyline

Format free

Each image format
freely definable

30 Frames/s

VGA (640 x 480)
30 F/s Mega

Virtual PTZ

Digital pan, tilt,
zoom

Backlight

Safe using CMOS
without mechanical iris

Internal DVR

Internal via Flash,
external via Network

Win/Lin/Mac

Recording

via Network on PC
up to 1 Terabyte

Microphone & speaker

Audio

bi-directional via IP,
variable frame rates

SIP-Client with video

IP Telephony

Alarm notify,
cam remote control

VideoMotion

Multiple windows
precision pixel-based

-22 to +140 °F

Weatherproof

-30 to +60 °C, IP65,
no heating necessary

IEEE 802.3af

PoE

Network power
even in winter

Robust

No moving parts
fiber glass housing

Mac/Win/Easy

Licence free

Video-Management-
Software

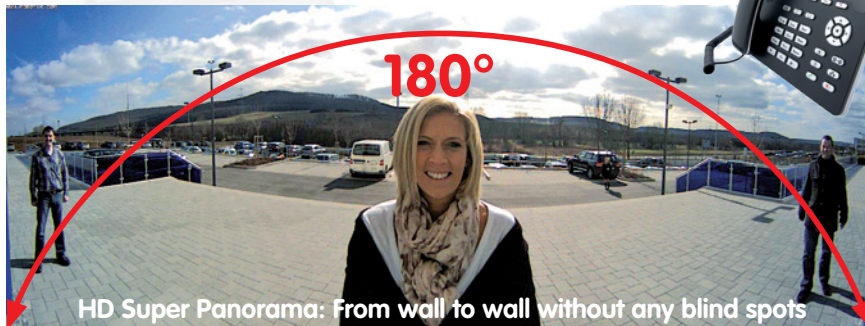

HD Super Panorama: From wall to wall without any blind spots

HiRes Video Innovations

The German company MOBOTIX AG is known as the leading pioneer in network camera technology and its decentralized concept has made high-resolution video systems cost efficient.

MOBOTIX AG • D-67722 Langmeil • Tel: +49-6302-9816-103 • Fax: +49-6302-9816-190 • sales@mobotix.com