



CERTIFICATE

Issued Date: March 17, 2011
Report No.: 113121R-ITCEP07V05

This is to certify that the following designated product

Product : Network Camera
Trade name : VIVOTEK
Model Number : SD8111, SD8121
Company Name : VIVOTEK INC.

This product, which has been issued the test report listed as above in Quietek Laboratory, is based on a single evaluation of one sample and confirmed to comply with the requirements of the following EMC standard.

EN 55022: 2006+A1: 2007

EN 61000-3-2: 2006+A2: 2009

EN 61000-3-3: 2008

AS/NZS CISPR 22: 2009

EN 55024: 1998+A1: 2001+A2: 2003

IEC 61000-4-2: 2008

IEC 61000-4-3: 2008

IEC 61000-4-4: 2004

IEC 61000-4-5: 2005

IEC 61000-4-6: 2008

IEC 61000-4-8: 2009

IEC 61000-4-11: 2004

TEST LABORATORY

Vincent Lin / Manager



Appendix Report

Product Name : Network Camera

Model No. : SD8111, SD8121

Applicant : VIVOTEK INC.

Address : 6F, No.192, Lien-Cheng Rd., Chung-Ho,
New Taipei City, 235, Taiwan, R.O.C.

Date of Receipt : 2011/03/08

Issued Date : 2011/03/17

Report No. : 113121R-ITCEP07V05

Report Version : V1.0

The test results relate only to the samples tested.

The test results shown in the test report are traceable to the national/international standard through the calibration of the equipment and evaluated measurement uncertainty herein.

This report must not be used to claim product endorsement by TAF, NVLAP or any agency of the Government.

The test report shall not be reproduced except in full without the written approval of QuieTek Corporation.



Declaration of Conformity

We herewith confirm the following designated products to comply with the requirements set out in the Council Directive on the approximation of the laws of the Member States relating to Electromagnetic Compatibility Directive (2004/108/EC) with applicable standards listed below.

Product : Network Camera
Trade name : VIVOTEK
Model Number : SD8111, SD8121
Applicable Harmonized : EN 55022: 2006+A1: 2007, Class A
Standards under Directive EN 55024: 1998+A1: 2001+A2: 2003
2004/108/EC EN 61000-3-2:2006+A2: 2009, Class A
EN 61000-3-3:2008

Company Name : _____
Company Address : _____
Telephone : _____ Facsimile : _____

Person in responsible for marking this declaration:

_____ Name (Full Name)	_____ Title/ Department
_____ Date	_____ Legal Signature



Statement of Conformity

This statement is to certify that the designated product below.

Product : Network Camera
Trade name : VIVOTEK
Model Number : SD8111, SD8121
Company Name : VIVOTEK INC.
Applicable Standards : EN 55022: 2006+A1: 2007, Class A
EN 55024: 1998+A1: 2001+A2: 2003
EN 61000-3-2:2006+A2: 2009, Class A
EN 61000-3-3:2008

One sample of the designated product has been tested and evaluated in our laboratory to find in compliance with the applicable standards above. The issued test report(s) show(s) it in detail.

Report Number : 113121R-ITCEP07V05



The verification is based on a single evaluation of one sample of above-mentioned products. It does not imply an assessment of the whole production and does not permit the use of the test lab. Logo.

Test Report Certification

Issued Date : 2011/03/17

Report No. : 113121R-ITCEP07V05



Product Name : Network Camera
Applicant : VIVOTEK INC.
Address : 6F, No.192, Lien-Cheng Rd., Chung-Ho, New Taipei City, 235,
Taiwan, R.O.C.
Manufacturer : VIVOTEK INC.
Model No. : SD8111, SD8121
EUT Rated Voltage : AC 100-240V, 50-60Hz
EUT Test Voltage : AC 230V / 50Hz
Trade Name : VIVOTEK
Applicable Standard : EN 55022: 2006+A1: 2007, Class A
EN 55024: 1998+A1: 2001+A2: 2003
EN 61000-3-2:2006+A2: 2009
EN 61000-3-3:2008
AS/NZS CISPR 22: 2009
Test Result : Complied
Performed Location : Quietek Corporation (Linkou Laboratory)
No. 5-22, Rueishu Keng, Linkou Dist., New Taipei City 24451,
Taiwan. R.O.C.
TEL:+866-2-8601-3788 / FAX:+886-2-8601-3789

Documented By :

(Senior Adm. Specialist / Rita Huang)

Reviewed By :

(Engineer / Kakira Wu)

Approved By :

(Manager / Vincent Lin)

Laboratory Information

We, **QuietTek Corporation**, are an independent EMC and safety consultancy that was established the whole facility in our laboratories. The test facility has been accredited/accepted (audited or listed) by the following related bodies in compliance with ISO 17025, EN 45001 and specified testing scopes:

Taiwan R.O.C.	:	BSMI, NCC, TAF
Germany	:	TUV Rheinland
Norway	:	Nemko, DNV
USA	:	FCC, NVLAP
Japan	:	VCCI

The related certificate for our laboratories about the test site and management system can be downloaded from QuietTek Corporation's Web Site : <http://www.quietek.com/tw/ctg/cts/accreditations.htm>
 The address and introduction of QuietTek Corporation's laboratories can be founded in our Web site : <http://www.quietek.com/>

If you have any comments, Please don't hesitate to contact us. Our contact information is as below:

HsinChu Testing Laboratory :

No.75-2, 3rd Lin, Wangye Keng, Yonghxing Tsuen, Qionglin Shiang, Hsinchu County 307, Taiwan, R.O.C.

TEL:+886-3-592-8858 / FAX:+886-3-592-8859 E-Mail : service@quietek.com



LinKou Testing Laboratory :

No. 5-22, Rueishu Keng, Linkou Dist., New Taipei City 24451, Taiwan. R.O.C

TEL : 886-2-8601-3788 / FAX : 886-2-8601-3789 E-Mail : service@quietek.com



Suzhou (China) Testing Laboratory :

No. 99 Hongye Rd., Suzhou Industrial Park Loufeng Hi-Tech Development Zone., Suzhou,China.

TEL : +86-512-6251-5088 / FAX : +86-512-6251-5098 E-Mail : service@quietek.com



TABLE OF CONTENTS

Description	Page
1. General Information	7
1.1. EUT Description.....	7
1.2. Mode of Operation	8
1.3. Tested System Details	9
1.4. Configuration of Tested System	10
1.5. EUT Exercise Software.....	11
2. Technical Test	12
2.1. Summary of Test Result.....	12
2.2. List of Test Equipment	13
2.3. Measurement Uncertainty.....	16
2.4. Test Environment.....	18
3. Conducted Emission (Main Terminals).....	19
3.1. Test Specification	19
3.2. Test Setup.....	19
3.3. Limit	19
3.4. Test Procedure	20
3.5. Deviation from Test Standard.....	20
3.6. Test Result	21
3.7. Test Photograph	27
4. Conducted Emissions (Telecommunication Ports).....	28
4.1. Test Specification	28
4.2. Test Setup.....	28
4.3. Limit	28
4.4. Test Procedure	29
4.5. Deviation from Test Standard.....	29
4.6. Test Result	30
4.7. Test Photograph	36
5. Radiated Emission	37
5.1. Test Specification	37
5.2. Test Setup.....	37
5.3. Limit	38
5.4. Test Procedure	39
5.5. Deviation from Test Standard.....	39
5.6. Test Result	40
5.7. Test Photograph	44
6. Harmonic Current Emission	46

6.1.	Test Specification	46
6.2.	Test Setup.....	46
6.3.	Limit.....	46
6.4.	Test Procedure	48
6.5.	Deviation from Test Standard	48
6.6.	Test Result.....	49
6.7.	Test Photograph	51
7.	Voltage Fluctuation and Flicker.....	52
7.1.	Test Specification	52
7.2.	Test Setup.....	52
7.3.	Limit.....	52
7.4.	Test Procedure	53
7.5.	Deviation from Test Standard	53
7.6.	Test Result.....	54
7.7.	Test Photograph	55
8.	Electrostatic Discharge	56
8.1.	Test Specification	56
8.2.	Test Setup.....	56
8.3.	Limit.....	56
8.4.	Test Procedure	57
8.5.	Deviation from Test Standard	57
8.6.	Test Result.....	58
8.7.	Test Photograph	59
9.	Radiated Susceptibility	60
9.1.	Test Specification	60
9.2.	Test Setup.....	60
9.3.	Limit.....	60
9.4.	Test Procedure	61
9.5.	Deviation from Test Standard	61
9.6.	Test Result.....	62
9.7.	Test Photograph	63
10.	Electrical Fast Transient/Burst	64
10.1.	Test Specification	64
10.2.	Test Setup.....	64
10.3.	Limit.....	64
10.4.	Test Procedure	65
10.5.	Deviation from Test Standard	65
10.6.	Test Result.....	66

10.7.	Test Photograph	67
11.	Surge	68
11.1.	Test Specification	68
11.2.	Test Setup.....	68
11.3.	Limit.....	68
11.4.	Test Procedure	69
11.5.	Deviation from Test Standard.....	69
11.6.	Test Result.....	70
11.7.	Test Photograph	71
12.	Conducted Susceptibility	72
12.1.	Test Specification	72
12.2.	Test Setup.....	72
12.3.	Limit.....	73
12.4.	Test Procedure	73
12.5.	Deviation from Test Standard.....	73
12.6.	Test Result.....	74
12.7.	Test Photograph	75
13.	Power Frequency Magnetic Field	76
13.1.	Test Specification	76
13.2.	Test Setup.....	76
13.3.	Limit.....	76
13.4.	Test Procedure	76
13.5.	Deviation from Test Standard.....	76
13.6.	Test Result.....	77
13.7.	Test Photograph	78
14.	Voltage Dips and Interruption.....	79
14.1.	Test Specification	79
14.2.	Test Setup.....	79
14.3.	Limit.....	79
14.4.	Test Procedure	80
14.5.	Deviation from Test Standard.....	80
14.6.	Test Result.....	81
14.7.	Test Photograph	82
15.	Attachment	83
	EUT Photograph.....	83

1. General Information

1.1. EUT Description

Product Name	Network Camera
Trade Name	VIVOTEK
Model No.	SD8111, SD8121

Component	
Power Adapter	MFR: L.T.E., M/N: LTE60E-S2-1 Input: AC 100-240V, 47-63Hz, 2A Output: DC 12V, 5A, MAX: 60W Cable Out: Non-shielded, 1.2m

Note:

1. This appendix report was based on Quietek report No. 108328R-ITCEP07V05. The different is adding Adapter.
2. The different for the Sensor is shown as below:

Model Number	Description
SD8111	For NTSC
SD8121	For PAL

1.2. Mode of Operation

QuieTek has verified the construction and function in typical operation. All the test modes were carried out with the EUT in normal operation, which was shown in this test report and defined as:

Pre-Test Mode	
Mode 1: Normal Operation	
Final Test Mode	
Emission	Mode 1: Normal Operation
Immunity	Mode 1: Normal Operation

1.3. Tested System Details

The types for all equipments, plus descriptions of all cables used in the tested system (including inserted cards) are:

Product	Manufacturer	Model No.	Serial No.	Power Cord	
1	Monitor	SONY	PVM-14M2U	2111389	Non-Shielded, 1.8m
2	Microphone & Earphone (EMI)	PCHOME	N/A	N/A	N/A
	Microphone & Earphone (EMS)	Ergotech	ET-E201	N/A	
3	Notebook PC	DELL	D630	00144-023-351-283	Non-Shielded, 1.8m

1.4. Configuration of Tested System

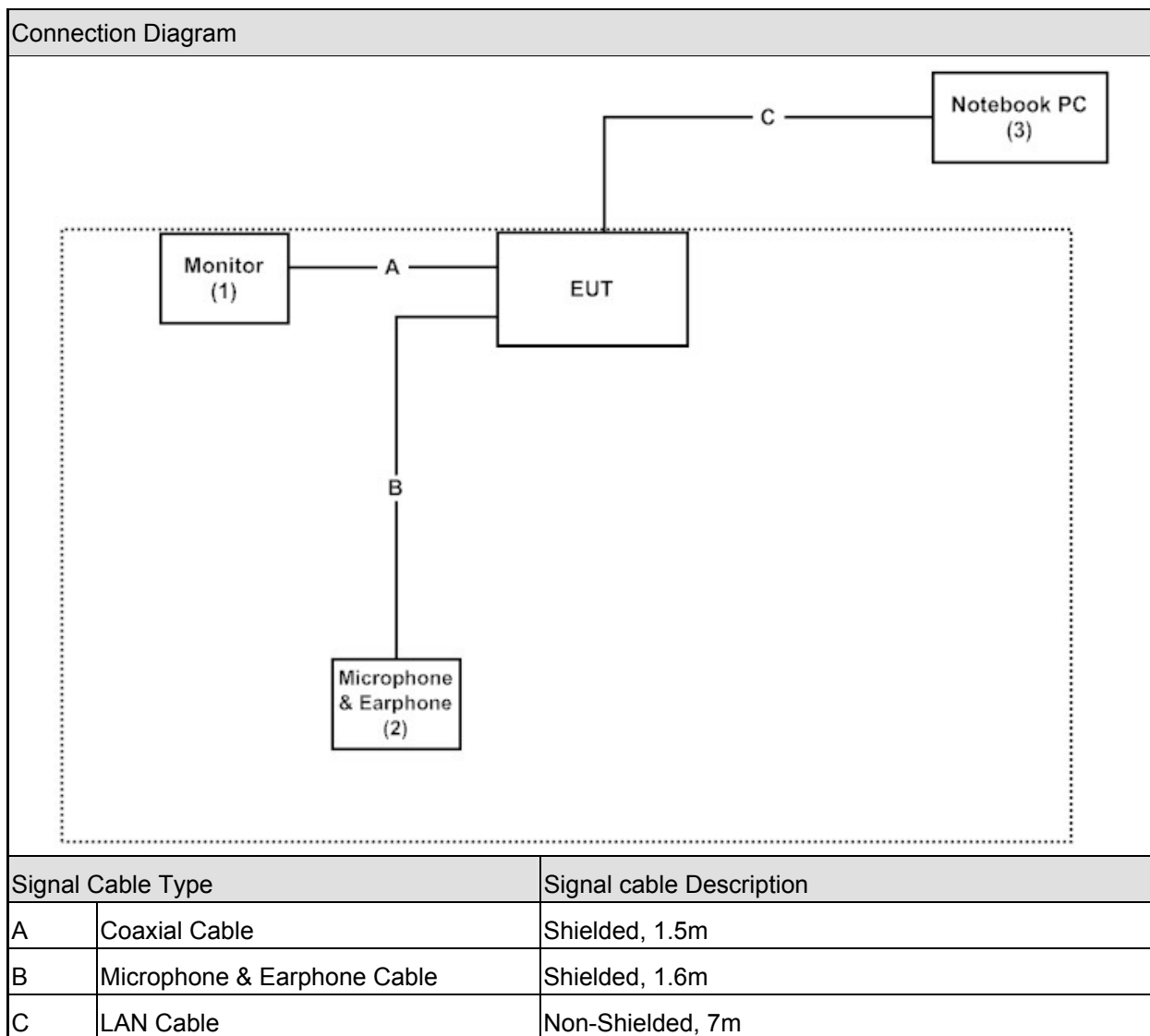

1.5. EUT Exercise Software

1	Setup the EUT and simulators as shown on 1.4.
2	Turn on the power of all equipment.
3	The EUT will start to operate and display the video figure from the signal source.
4	The EUT will display “video figure” on monitor.
5	Repeat the above procedure (3) to (4).

2. Technical Test

2.1. Summary of Test Result

- No deviations from the test standards
 Deviations from the test standards as below description:

Emission			
Performed Item	Normative References	Test Performed	Deviation
Conducted Emission	EN 55022: 2006+A1: 2007 AS/NZS CISPR 22: 2009	Yes	No
Impedance Stabilization Network	EN 55022: 2006+A1: 2007 AS/NZS CISPR 22: 2009	Yes	No
Radiated Emission	EN 55022: 2006+A1: 2007 AS/NZS CISPR 22: 2009	Yes	No
Power Harmonics	EN 61000-3-2:2006+A2: 2009	Yes	No
Voltage Fluctuation and Flicker	EN 61000-3-3:2008	Yes	No

Immunity			
Performed Item	Normative References	Test Performed	Deviation
Electrostatic Discharge	IEC 61000-4-2: 2008	Yes	No
Radiated susceptibility	IEC 61000-4-3: 2008	Yes	No
Electrical fast transient/burst	IEC 61000-4-4: 2004	Yes	No
Surge	IEC 61000-4-5: 2005	Yes	No
Conducted susceptibility	IEC 61000-4-6: 2008	Yes	No
Power frequency magnetic field	IEC 61000-4-8: 2009	Yes	No
Voltage dips and interruption	IEC 61000-4-11: 2004	Yes	No

2.2. List of Test Equipment

Conducted Emission / SR1

Instrument	Manufacturer	Type No.	Serial No	Cal. Date
EMI Test Receiver	R&S	ESCS 30	100366	2010/10/29
LISN	R&S	ENV4200	833209/007	2010/08/14
LISN	R&S	ENV216	100085	2011/02/17
Pulse Limiter	R&S	ESH3-Z2	357.88.10.52	2010/09/10

Impedance Stabilization Network / SR1

Instrument	Manufacturer	Type No.	Serial No	Cal. Date
Capacitive Voltage Probe	Schaffner	CVP2200A	18331	2010/11/16
EMI Test Receiver	R&S	ESCS 30	100366	2010/10/29
LISN	R&S	ENV216	100085	2011/02/17
LISN	R&S	ENV4200	833209/007	2010/08/14
Pulse Limiter	R&S	ESH3-Z2	357.88.10.52	2010/09/10
RF Current Probe	FCC	F-65 10KHz~1GHz	198	2010/11/13
BALANCED TELECOM ISN	FCC	FCC-TLISN-T2-02	20316	2010/11/22
BALANCED TELECOM ISN	FCC	FCC-TLISN-T4-02	20317	2010/11/22
BALANCED TELECOM ISN	FCC	FCC-TLISN-T8-02	20319	2010/11/22

Radiated Emission / Site3

Instrument	Manufacturer	Type No.	Serial No	Cal. Date
Bilog Antenna	Schaffner Chase	CBL6112B	2704	2010/08/01
Broadband Horn Antenna	Schwarzbeck	BBHA9170	209	2010/10/27
EMI Test Receiver	R&S	ESCS 30	100149	2011/02/09
Horn Antenna	Schwarzbeck	BBHA9120D	305	2010/08/26
Pre-Amplifier	QTK	N/A	N/A	2010/08/01
Spectrum Analyzer	Advantest	R3162	100803470	2010/11/24
EMI Test Receiver	R&S	ESI 26	838786/004	2010/06/26
Pre-Amplifier	MITEQ	QMF-4D-18040 0-45-6P	925974	2011/01/03

Radiated Emission / 9x6x6 Chamber

Instrument	Manufacturer	Type No.	Serial No	Cal. Date
Spectrum Analyzer (9K-26.5GHz)	Agilent	E4408B	MY45102743	2010/08/12
Horn Antenna	Schwarzbeck	9120D	576	2010/10/21
Pre-Amplifier	Quietek	AP-180C	CHM/071920	2010/08/04

Power Harmonics / SR3

Instrument	Manufacturer	Type No.	Serial No	Cal. Date
AC Power Source(Harmonic)	Schaffner	NSG 1007	HK54148	2010/08/11
IEC1000-4-X Analyzer(Flicker)	Schaffner	CCN 1000-1	X7 1887	2010/08/11

Voltage Fluctuation and Flicker / SR3

Instrument	Manufacturer	Type No.	Serial No	Cal. Date
AC Power Source(Harmonic)	Schaffner	NSG 1007	HK54148	2010/08/11
IEC1000-4-X Analyzer(Flicker)	Schaffner	CCN 1000-1	X7 1887	2010/08/11

Electrostatic Discharge / SR6

Instrument	Manufacturer	Type No.	Serial No	Cal. Date
ESD Simulator System	Noiseken	TC-815R	ESS0929097	2010/08/30
Horizontal Coupling Plane(HCP)	Quietek	HCP AL50	N/A	N/A
Vertical Coupling Plane(VCP)	Quietek	VCP AL50	N/A	N/A

Radiated susceptibility / CB5

Instrument	Manufacturer	Type No.	Serial No	Cal. Date
AF-BOX	R&S	AF-BOX ACCUST	100007	N/A
Audio Analyzer	R&S	UPL 16	100137	2010/04/15
Biconilog Antenna	EMCO	3149	00071675	N/A
Directional Coupler	A&R	DC 6180	22735	N/A
Dual Microphone Supply	B&K	5935	2426784	2010/04/16
Mouth Simulator	B&K	4227	2439692	2010/04/16
Power Amplifier	A&R	30S1G3	309453	N/A
Power Amplifier	A&R	100W10000M7	A285000010	N/A
Power Amplifier	SCHAFFNER	CBA9413B	4020	N/A
Power Amplifier	AR	75A250A	0325371	N/A
Power Meter	R&S	NRVD(P.M)	100219	2010/04/16
Pre-Amplifier	A&R	150A220	23067	N/A
Probe Microphone	B&K	4182	2278070	2010/04/16
Signal Generator	R&S	SML03	103330	2010/04/16

Electrical fast transient/burst / SR3

Instrument	Manufacturer	Type No.	Serial No	Cal. Date
TRANSIENT TEST SYSTEM	EMC PARTNER	TRA2000IN6	1138	2010/12/09

Surge / SR3

Instrument	Manufacturer	Type No.	Serial No	Cal. Date
TRANSIENT TEST SYSTEM	EMC PARTNER	TRA2000IN6	1138	2010/12/09

Conducted susceptibility / SR6

Instrument	Manufacturer	Type No.	Serial No	Cal. Date
Schaffner NSG 2070 RF-Generator	Schaffner	N/A	N/A	2010/04/21

Power frequency magnetic field / SR3

Instrument	Manufacturer	Type No.	Serial No	Cal. Date
Induction Coil Interface	Schaffner	INA 2141	6002	N/A
Magnetic Loop Coil	Schaffner	INA 702	160	N/A
Triaxial ELF Magnetic Field Meter	F.B.BELL	4090	114135	2010/03/27

Voltage dips and interruption / SR3

Instrument	Manufacturer	Type No.	Serial No	Cal. Date
TRANSIENT TEST SYSTEM	EMC PARTNER	TRA2000IN6	1138	2010/12/09

Schaffner NSG 2070 RF-Generator				
Instrument	Manufacturer	Type No.	Serial No	Cal. Date
CDN	Schaffner	CAL U100A	20405	N/A
CDN	Schaffner	TRA U150	20454	N/A
CDN M016S	Schaffner	CAL U100A	20410	N/A
CDN M016S	Schaffner	TRA U150	21167	N/A
CDN T002	Schaffner	CAL U100	20491	N/A
CDN T002	Schaffner	TRA U150	21169	N/A
CDN T400	Schaffner	CAL U100	17735	N/A
CDN T400	Schaffner	TRA U150	21166	N/A
Coupling Decoupling Network	Schaffner	CDN M016S	20823	2010/04/02
Coupling Decoupling Network	Schaffner	CDN T002	19018	2010/04/02
Coupling Decoupling Network	Schaffner	CDN T400	21226	2010/04/02
EM-CLAMP	Schaffner	KEMZ 801	21024	2010/04/02

2.3. Measurement Uncertainty

Conducted Emission

The measurement uncertainty is evaluated as ± 2.26 dB.

Impedance Stabilization Network

The measurement uncertainty is evaluated as ± 2.26 dB.

Radiated Emission

The measurement uncertainty is evaluated as ± 3.19 dB.

Electrostatic Discharge

As what is concluded in the document from Note2 of clause 5.4.6.2 of ISO/IEC 17025: 1999[2], the requirements for measurement uncertainty in ESD testing are deemed to have been satisfied, and the testing is reported in accordance with the relevant ESD standards. The immunity test signal from the ESD system meet the required specifications in IEC 61000-4-2 through the calibration report with the calibrated uncertainty for the waveform of voltage and timing as being 1.0 % and 0.1%.

Radiated susceptibility

As what is concluded in the document from Note2 of clause 5.4.6.2 of ISO/IEC 17025: 1999[2], the requirements for measurement uncertainty in RS testing are deemed to have been satisfied, and the testing is reported in accordance with the relevant RS standards. The immunity test signal from the RS system meet the required specifications in IEC 61000-4-3 through the calibration for the uniform field strength and monitoring for the test level with the uncertainty evaluation report for the electrical field strength as being 3.57 dB.

Electrical fast transient/burst

As what is concluded in the document from Note2 of clause 5.4.6.2 of ISO/IEC 17025: 1999[2], the requirements for measurement uncertainty in EFT/Burst testing are deemed to have been satisfied, and the testing is reported in accordance with the relevant EFT/Burst standards. The immunity test signal from the EFT/Burst system meet the required specifications in IEC 61000-4-4 through the calibration report with the calibrated uncertainty for the waveform of voltage, frequency and timing as being 4 %, and 2.5%.

Surge

As what is concluded in the document from Note2 of clause 5.4.6.2 of ISO/IEC 17025: 1999[2], the requirements for measurement uncertainty in Surge testing are deemed to have been satisfied, and the testing is reported in accordance with the relevant Surge standards. The immunity test signal from the Surge system meet the required specifications in IEC 61000-4-5 through the calibration report with the calibrated uncertainty for the waveform of voltage and timing as being 3.5 % and 0.1%.

Conducted susceptibility

As what is concluded in the document from Note2 of clause 5.4.6.2 of ISO/IEC 17025: 1999[2], the requirements for measurement uncertainty in CS testing are deemed to have been satisfied, and the testing is reported in accordance with the relevant CS standards. The immunity test signal from the CS system meet the required specifications in IEC 61000-4-6 through the calibration for unmodulated signal and monitoring for the test level with the uncertainty evaluation report for the injected modulated signal level through CDN and EM Clamp/Direct Injection as being 2.0 dB and 2.61 dB.

Power frequency magnetic field

As what is concluded in the document from Note2 of clause 5.4.6.2 of ISO/IEC 17025: 1999[2], the requirements for measurement uncertainty in PFM testing are deemed to have been satisfied, and the testing is reported in accordance with the relevant PFM standards. The immunity test signal from the PFM system meet the required specifications in IEC 61000-4-8 through the calibration report with the calibrated uncertainty for the Gauss Meter to verify the output level of magnetic field strength as being 2.0 %.

Voltage dips and interruption

As what is concluded in the document from Note2 of clause 5.4.6.2 of ISO/IEC 17025: 1999[2], the requirements for measurement uncertainty in DIP testing are deemed to have been satisfied, and the testing is reported in accordance with the relevant DIP standards. The immunity test signal from the DIP system meet the required specifications in IEC 61000-4-11 through the calibration report with the calibrated uncertainty for the waveform of voltage and timing as being 3.5 % and 0.1%.

2.4. Test Environment

Performed Item	Items	Required	Actual
Conducted Emission	Temperature (°C)	15-35	25
	Humidity (%RH)	25-75	50
	Barometric pressure (mbar)	860-1060	950-1000
Impedance Stabilization Network	Temperature (°C)	15-35	25
	Humidity (%RH)	25-75	50
	Barometric pressure (mbar)	860-1060	950-1000
Radiated Emission	Temperature (°C)	15-35	25
	Humidity (%RH)	25-75	50
	Barometric pressure (mbar)	860-1060	950-1000
Electrostatic Discharge	Temperature (°C)	15-35	19
	Humidity (%RH)	30-60	43
	Barometric pressure (mbar)	860-1060	950-1000
Radiated susceptibility	Temperature (°C)	15-35	20
	Humidity (%RH)	25-75	46
	Barometric pressure (mbar)	860-1060	950-1000
Electrical fast transient/burst	Temperature (°C)	15-35	19
	Humidity (%RH)	25-75	43
	Barometric pressure (mbar)	860-1060	950-1000
Surge	Temperature (°C)	15-35	19
	Humidity (%RH)	10-75	43
	Barometric pressure (mbar)	860-1060	950-1000
Conducted susceptibility	Temperature (°C)	15-35	19
	Humidity (%RH)	25-75	52
	Barometric pressure (mbar)	860-1060	950-1000
Power frequency magnetic field	Temperature (°C)	15-35	19
	Humidity (%RH)	25-75	42
	Barometric pressure (mbar)	860-1060	950-1000
Voltage dips and interruption	Temperature (°C)	15-35	19
	Humidity (%RH)	25-75	42
	Barometric pressure (mbar)	860-1060	950-1000

3. Conducted Emission (Main Terminals)

3.1. Test Specification

According to EMC Standard : EN 55022 and AS/NZS CISPR 22

3.2. Test Setup

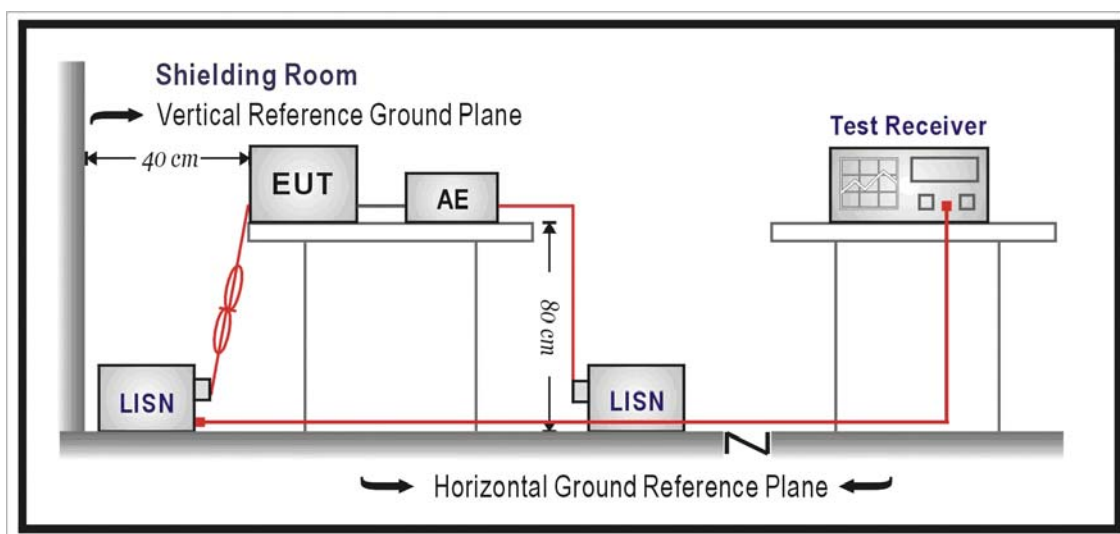

3.3. Limit

Limits		
Frequency (MHz)	QP (dBuV)	AV (dBuV)
0.15 - 0.50	79	66
0.50-5.0	73	60
5.0 - 30	73	60

Remarks: In the above table, the tighter limit applies at the band edges.

3.4. Test Procedure

The EUT and simulators are connected to the main power through a line impedance stabilization network (L.I.S.N.). This provides a 50 ohm /50uH coupling impedance for the measuring equipment. The peripheral devices are also connected to the main power through a LISN that provides a 50ohm/50uH coupling impedance with 50ohm termination.

(Please refers to the block diagram of the test setup and photographs.)

Both sides of A.C. line are checked for maximum conducted interference. In order to find the maximum emission, the relative positions of equipment and all of the interface cables must be changed on conducted measurement.

Conducted emissions were invested over the frequency range from 0.15MHz to 30MHz using a receiver bandwidth of 9kHz.

3.5. Deviation from Test Standard

No deviation.

3.6. Test Result

Site : SR_1	Time : 2011/03/11 - 23:44
Limit : CISPR_A_00M_QP	Margin : 10
EUT : Network Camera	Probe : ENV_216_L1 - Line1
Power : AC 230V/50Hz	Note : Mode 1

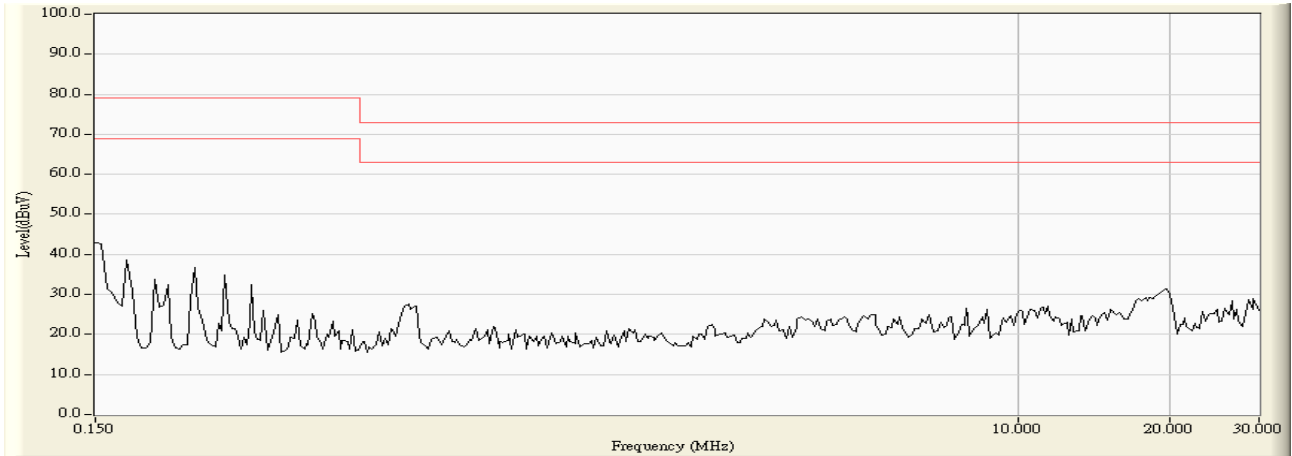

Site : SR_1	Time : 2011/03/11 - 23:45
Limit : CISPR_A_00M_QP	Margin : 0
EUT : Network Camera	Probe : ENV_216_L1 - Line1
Power : AC 230V/50Hz	Note : Mode 1

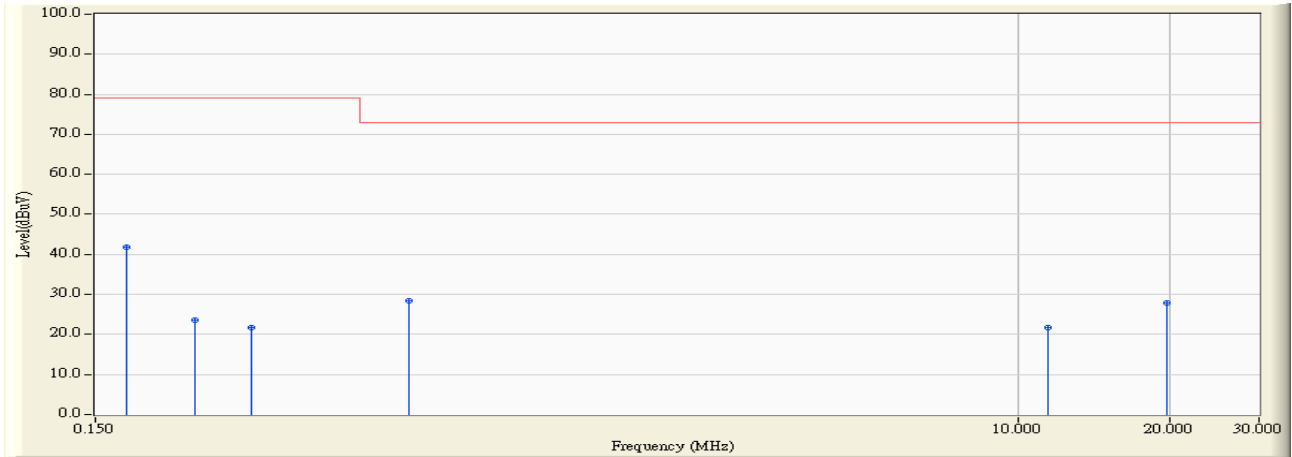

		Frequency (MHz)	Correct Factor (dB)	Reading Level (dBuV)	Measure Level (dBuV)	Margin (dB)	Limit (dBuV)	Detector Type
1	*	0.173	9.790	31.990	41.780	-37.220	79.000	QUASIPeAK
2		0.236	9.790	13.890	23.680	-55.320	79.000	QUASIPeAK
3		0.306	9.790	11.830	21.620	-57.380	79.000	QUASIPeAK
4		0.627	9.790	18.530	28.320	-44.680	73.000	QUASIPeAK
5		11.466	9.919	11.850	21.769	-51.231	73.000	QUASIPeAK
6		19.775	10.110	17.710	27.820	-45.180	73.000	QUASIPeAK

Note:

1. All Reading Levels are Quasi-Peak and average value.
2. " * ", means this data is the worst emission level.
3. Measurement Level = Reading Level + Correct Factor

Site : SR_1	Time : 2011/03/11 - 23:45
Limit : CISPR_A_00M_AV	Margin : 0
EUT : Network Camera	Probe : ENV_216_L1 - Line1
Power : AC 230V/50Hz	Note : Mode 1

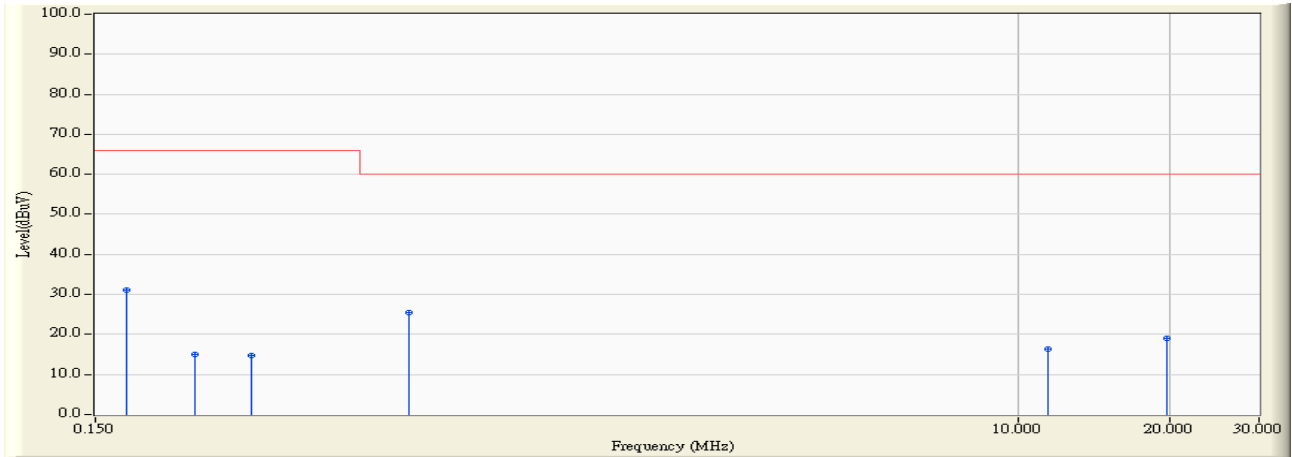

		Frequency (MHz)	Correct Factor (dB)	Reading Level (dBuV)	Measure Level (dBuV)	Margin (dB)	Limit (dBuV)	Detector Type
1		0.173	9.790	21.360	31.150	-34.850	66.000	AVERAGE
2		0.236	9.790	5.100	14.890	-51.110	66.000	AVERAGE
3		0.306	9.790	5.050	14.840	-51.160	66.000	AVERAGE
4	*	0.627	9.790	15.690	25.480	-34.520	60.000	AVERAGE
5		11.466	9.919	6.550	16.469	-43.531	60.000	AVERAGE
6		19.775	10.110	8.940	19.050	-40.950	60.000	AVERAGE

Note:

1. All Reading Levels are Quasi-Peak and average value.
2. " * ", means this data is the worst emission level.
3. Measurement Level = Reading Level + Correct Factor

Site : SR_1	Time : 2011/03/11 - 23:46
Limit : CISPR_A_00M_QP	Margin : 10
EUT : Network Camera	Probe : ENV_216_N - Line2
Power : AC 230V/50Hz	Note : Mode 1

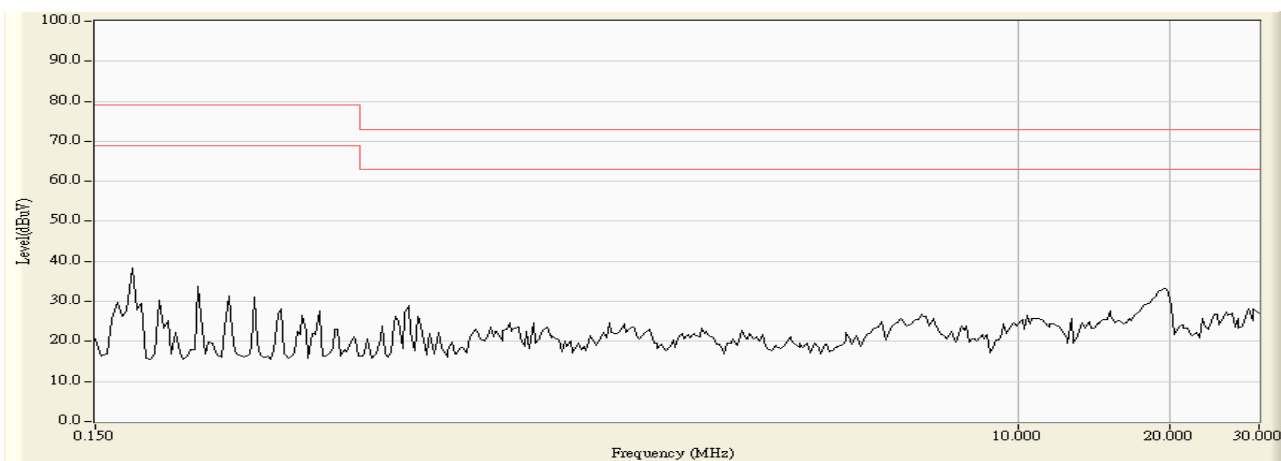

Site : SR_1	Time : 2011/03/11 - 23:47
Limit : CISPR_A_00M_QP	Margin : 0
EUT : Network Camera	Probe : ENV_216_N - Line2
Power : AC 230V/50Hz	Note : Mode 1

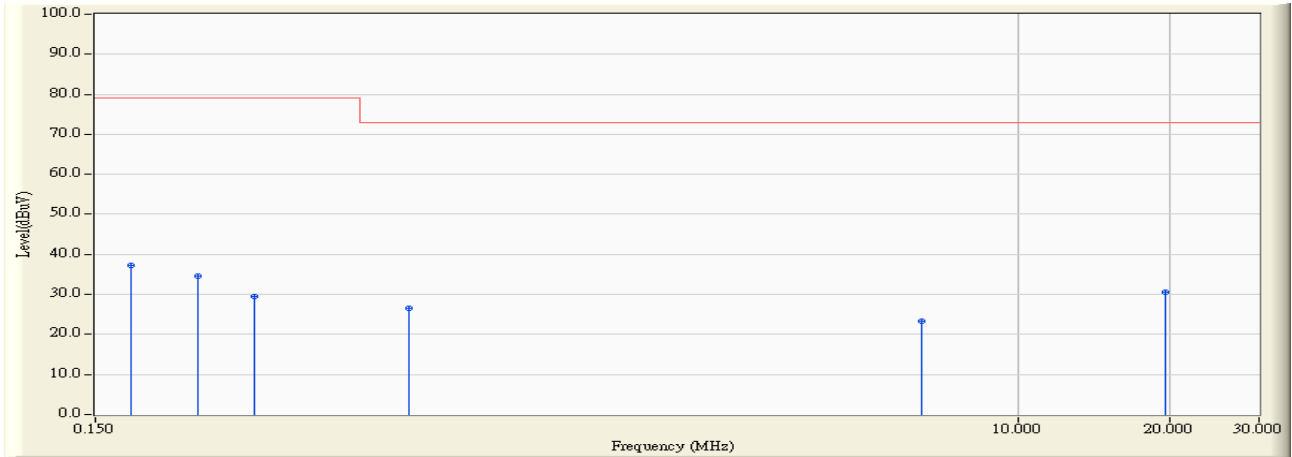

		Frequency (MHz)	Correct Factor (dB)	Reading Level (dBuV)	Measure Level (dBuV)	Margin (dB)	Limit (dBuV)	Detector Type
1	*	0.177	9.780	27.490	37.270	-41.730	79.000	QUASIPeAK
2		0.240	9.780	24.830	34.610	-44.390	79.000	QUASIPeAK
3		0.310	9.790	19.570	29.360	-49.640	79.000	QUASIPeAK
4		0.627	9.790	16.790	26.580	-46.420	73.000	QUASIPeAK
5		6.451	9.850	13.350	23.200	-49.800	73.000	QUASIPeAK
6		19.591	10.229	20.390	30.619	-42.381	73.000	QUASIPeAK

Note:

1. All Reading Levels are Quasi-Peak and average value.
2. " * ", means this data is the worst emission level.
3. Measurement Level = Reading Level + Correct Factor

Site : SR_1	Time : 2011/03/11 - 23:47
Limit : CISPR_A_00M_AV	Margin : 0
EUT : Network Camera	Probe : ENV_216_N - Line2
Power : AC 230V/50Hz	Note : Mode 1

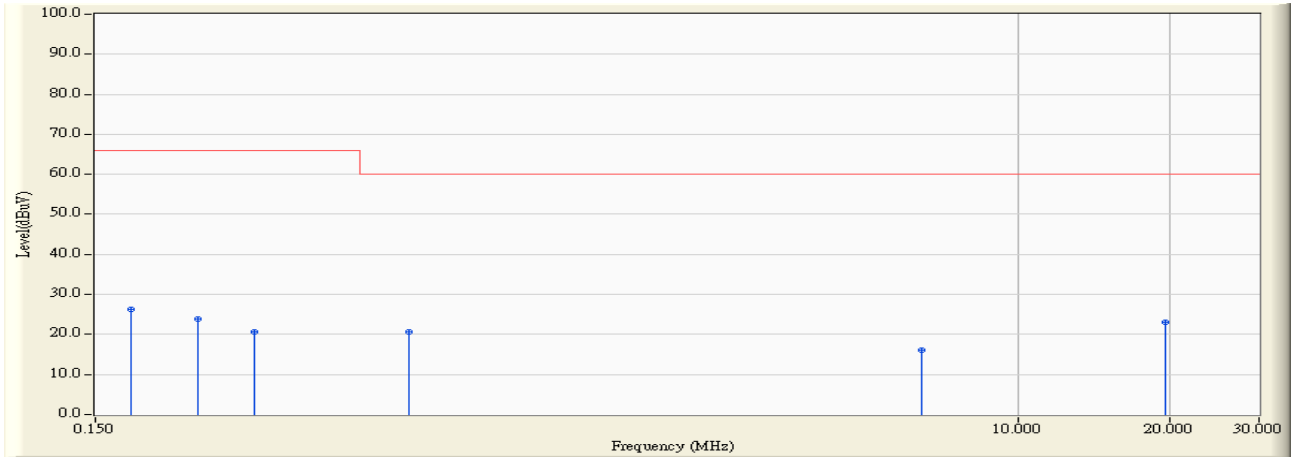

		Frequency (MHz)	Correct Factor (dB)	Reading Level (dBuV)	Measure Level (dBuV)	Margin (dB)	Limit (dBuV)	Detector Type
1		0.177	9.780	16.530	26.310	-39.690	66.000	AVERAGE
2		0.240	9.780	13.960	23.740	-42.260	66.000	AVERAGE
3		0.310	9.790	10.970	20.760	-45.240	66.000	AVERAGE
4		0.627	9.790	10.770	20.560	-39.440	60.000	AVERAGE
5		6.451	9.850	6.210	16.060	-43.940	60.000	AVERAGE
6	*	19.591	10.229	12.740	22.969	-37.031	60.000	AVERAGE

Note:

1. All Reading Levels are Quasi-Peak and average value.
2. " * ", means this data is the worst emission level.
3. Measurement Level = Reading Level + Correct Factor

3.7. Test Photograph

Test Mode : Mode 1: Normal Operation

Description : Front View of Conducted Test



Test Mode : Mode 1: Normal Operation

Description : Back View of Conducted Test



4. Conducted Emissions (Telecommunication Ports)

4.1. Test Specification

According to EMC Standard : EN 55022 and AS/NZS CISPR 22

4.2. Test Setup

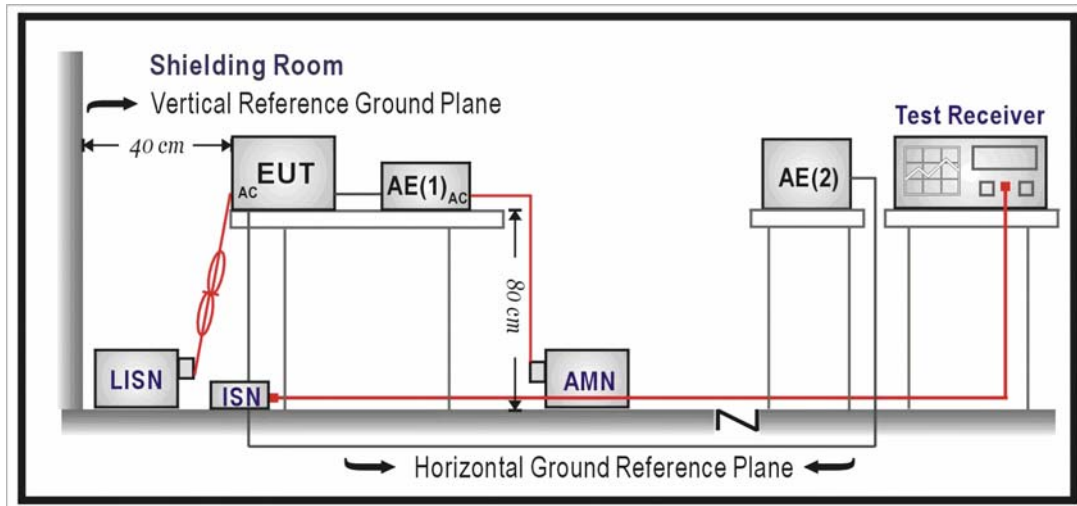

4.3. Limit

Limits		
Frequency (MHz)	QP (dBuV)	AV (dBuV)
0.15 - 0.50	97 – 87	84 – 74
0.50 - 30	87	74

Remarks:

The limit decreases linearly with the logarithm of the frequency in the range 0.15 MHz~0.50 MHz.

4.4. Test Procedure

Telecommunication Port:

The mains voltage shall be supplied to the EUT via the LISN when the measurement of telecommunication port is performed. The common mode disturbances at the telecommunication port shall be connected to the ISN, which is 150 ohm impedance.

Both alternative cables are tested related to the LCL requested. The measurement range is from 150kHz to 30MHz. The bandwidth of measurement is set to 9kHz.

The 75dB LCL ISN is used for cat. 6 cable, the 65dB LCL ISN is used for cat. 5 cable, 55dB LCL ISN is used for cat. 3.

4.5. Deviation from Test Standard

No deviation.

4.6. Test Result

Site : SR_1	Time : 2011/03/11 - 23:58
Limit : ISN_Voltage_A_00M_QP	Margin : 10
EUT : Network Camera	Probe : ISN_T4 - Line1
Power : AC 230V/50Hz	Note : Mode 1: ISN 10MB

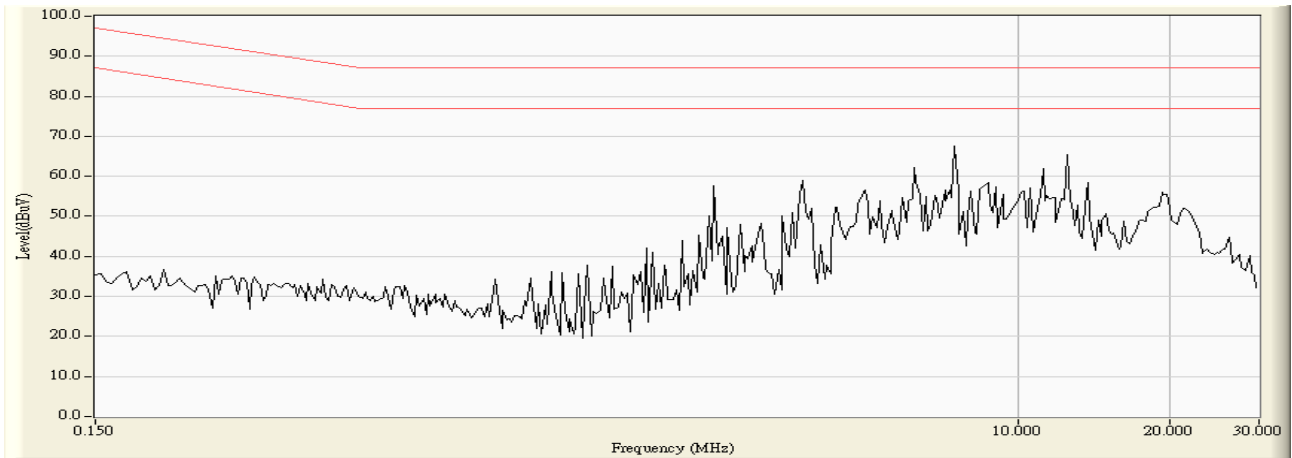

Site : SR_1	Time : 2011/03/11 - 23:59
Limit : ISN_Voltage_A_00M_QP	Margin : 0
EUT : Network Camera	Probe : ISN_T4 - Line1
Power : AC 230V/50Hz	Note : Mode 1: ISN 10MB

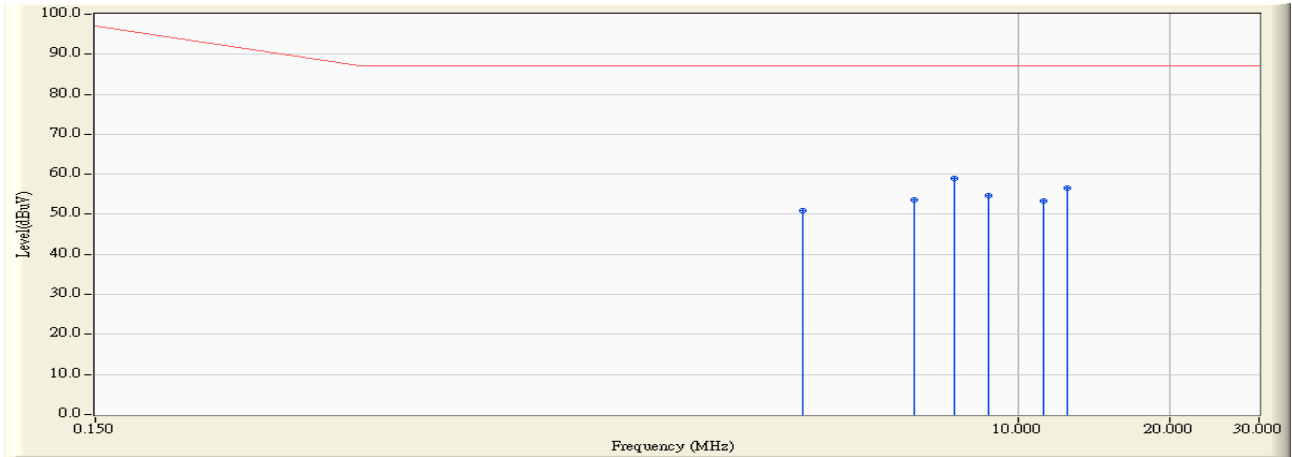

		Frequency (MHz)	Correct Factor (dB)	Reading Level (dBuV)	Measure Level (dBuV)	Margin (dB)	Limit (dBuV)	Detector Type
1		3.752	9.990	41.050	51.040	-35.960	87.000	QUASIPeAK
2		6.252	9.976	43.670	53.646	-33.354	87.000	QUASIPeAK
3	*	7.502	9.970	48.930	58.900	-28.100	87.000	QUASIPeAK
4		8.752	9.968	44.610	54.578	-32.422	87.000	QUASIPeAK
5		11.252	9.960	43.290	53.250	-33.750	87.000	QUASIPeAK
6		12.502	10.073	46.550	56.623	-30.377	87.000	QUASIPeAK

Note:

1. All Reading Levels are Quasi-Peak and average value.
2. " * ", means this data is the worst emission level.
3. Measurement Level = Reading Level + Correct Factor

Site : SR_1	Time : 2011/03/11 - 23:59
Limit : ISN_Voltage_A_00M_AV	Margin : 0
EUT : Network Camera	Probe : ISN_T4 - Line1
Power : AC 230V/50Hz	Note : Mode 1: ISN 10MB

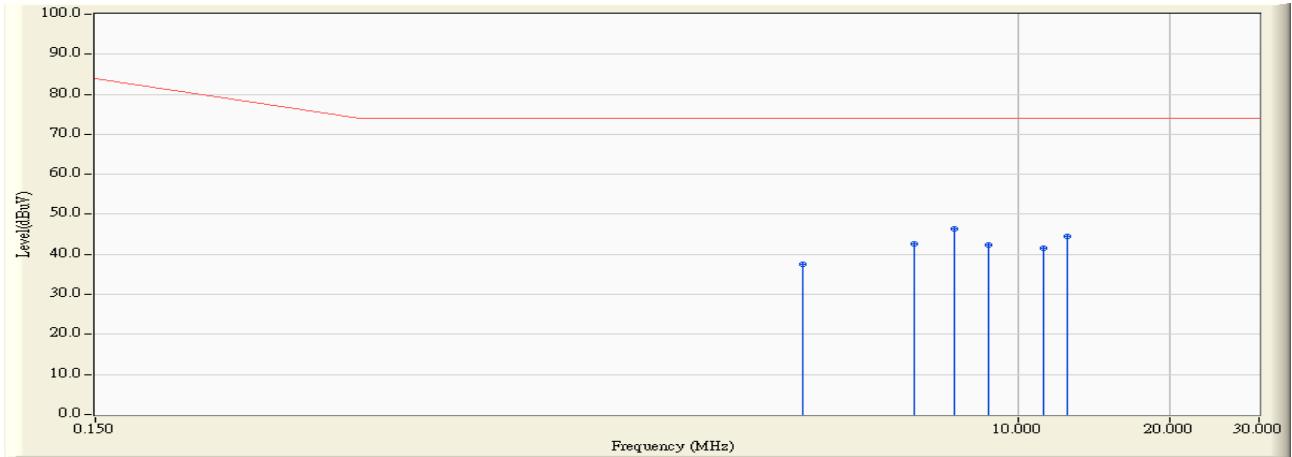

		Frequency (MHz)	Correct Factor (dB)	Reading Level (dBuV)	Measure Level (dBuV)	Margin (dB)	Limit (dBuV)	Detector Type
1		3.752	9.990	27.620	37.610	-36.390	74.000	AVERAGE
2		6.252	9.976	32.700	42.676	-31.324	74.000	AVERAGE
3	*	7.502	9.970	36.480	46.450	-27.550	74.000	AVERAGE
4		8.752	9.968	32.300	42.268	-31.732	74.000	AVERAGE
5		11.252	9.960	31.500	41.460	-32.540	74.000	AVERAGE
6		12.502	10.073	34.530	44.603	-29.397	74.000	AVERAGE

Note:

1. All Reading Levels are Quasi-Peak and average value.
2. " * ", means this data is the worst emission level.
3. Measurement Level = Reading Level + Correct Factor

Site : SR_1	Time : 2011/03/11 - 23:50
Limit : ISN_Voltage_A_00M_QP	Margin : 10
EUT : Network Camera	Probe : ISN_T4 - Line1
Power : AC 230V/50Hz	Note : Mode 1: ISN 100MB

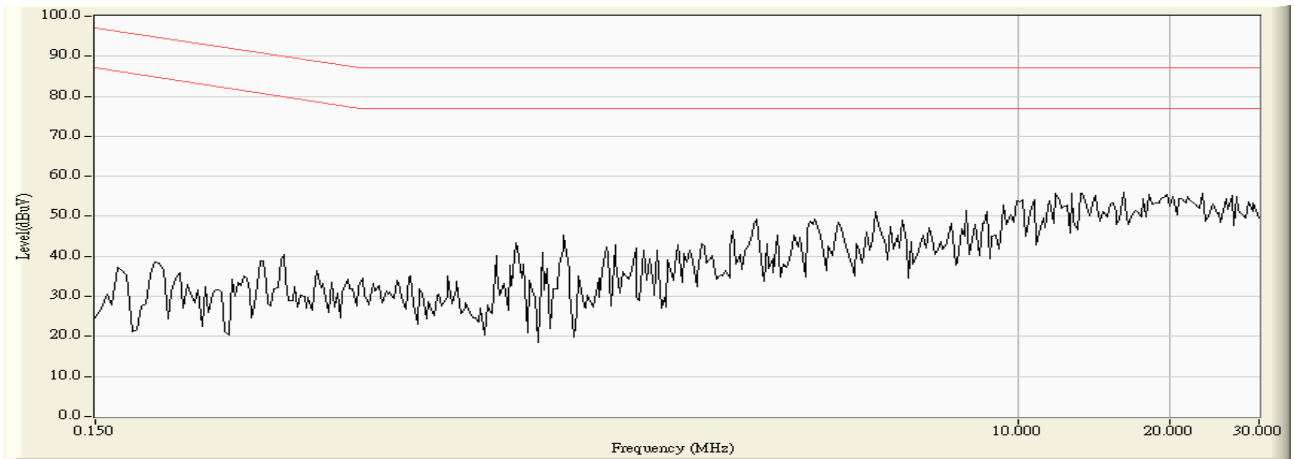

Site : SR_1	Time : 2011/03/11 - 23:51
Limit : ISN_Voltage_A_00M_QP	Margin : 0
EUT : Network Camera	Probe : ISN_T4 - Line1
Power : AC 230V/50Hz	Note : Mode 1: ISN 100MB

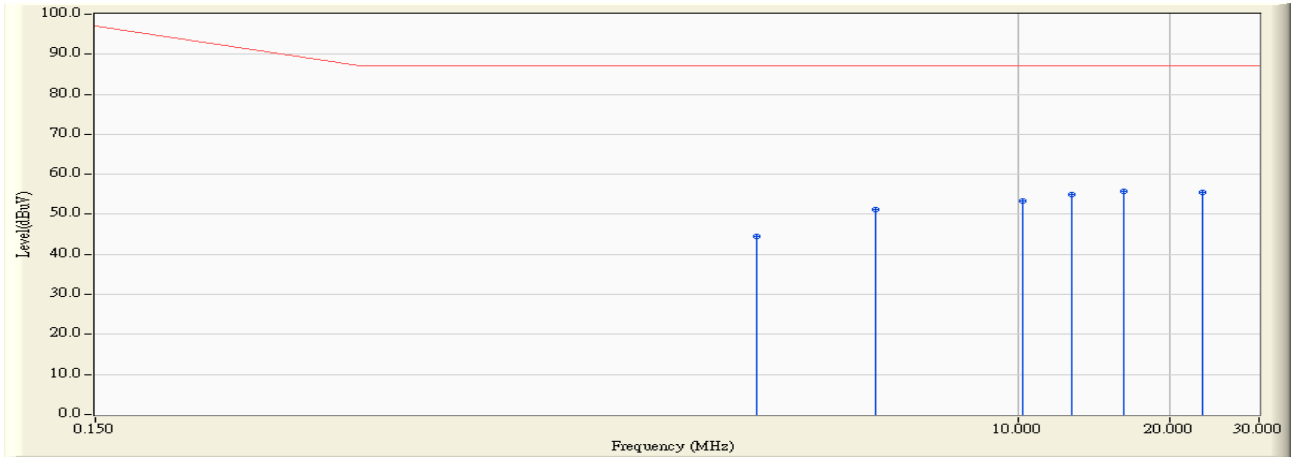

		Frequency (MHz)	Correct Factor (dB)	Reading Level (dBuV)	Measure Level (dBuV)	Margin (dB)	Limit (dBuV)	Detector Type
1		3.037	9.990	34.530	44.520	-42.480	87.000	QUASIPeAK
2		5.236	9.980	41.330	51.310	-35.690	87.000	QUASIPeAK
3		10.244	9.960	43.430	53.390	-33.610	87.000	QUASIPeAK
4		12.748	10.095	44.810	54.905	-32.095	87.000	QUASIPeAK
5	*	16.228	10.130	45.530	55.660	-31.340	87.000	QUASIPeAK
6		23.130	10.100	45.530	55.630	-31.370	87.000	QUASIPeAK

Note:

1. All Reading Levels are Quasi-Peak and average value.
2. " * ", means this data is the worst emission level.
3. Measurement Level = Reading Level + Correct Factor

Site : SR_1	Time : 2011/03/11 - 23:51
Limit : ISN_Voltage_A_00M_AV	Margin : 0
EUT : Network Camera	Probe : ISN_T4 - Line1
Power : AC 230V/50Hz	Note : Mode 1: ISN 100MB

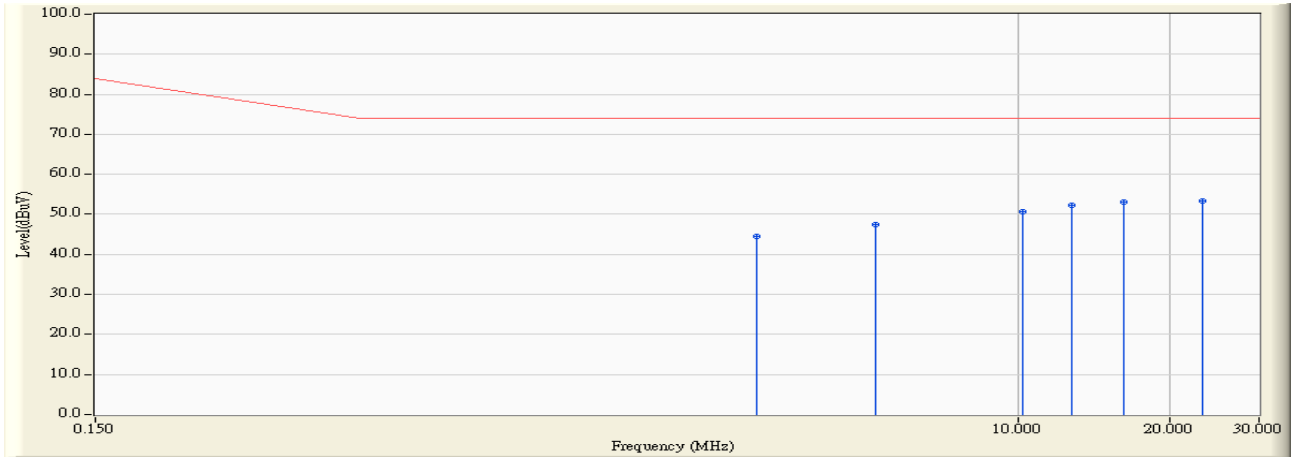

		Frequency (MHz)	Correct Factor (dB)	Reading Level (dBuV)	Measure Level (dBuV)	Margin (dB)	Limit (dBuV)	Detector Type
1		3.037	9.990	34.520	44.510	-29.490	74.000	AVERAGE
2		5.236	9.980	37.600	47.580	-26.420	74.000	AVERAGE
3		10.244	9.960	40.820	50.780	-23.220	74.000	AVERAGE
4		12.748	10.095	42.160	52.255	-21.745	74.000	AVERAGE
5		16.228	10.130	43.000	53.130	-20.870	74.000	AVERAGE
6	*	23.130	10.100	43.240	53.340	-20.660	74.000	AVERAGE

Note:

1. All Reading Levels are Quasi-Peak and average value.
2. " * ", means this data is the worst emission level.
3. Measurement Level = Reading Level + Correct Factor

4.7. Test Photograph

Test Mode : Mode 1: Normal Operation

Description : Front View of ISN Test



Test Mode : Mode 1: Normal Operation

Description : Back View of ISN Test



5. Radiated Emission

5.1. Test Specification

According to EMC Standard : EN 55022 and AS/NZS CISPR 22

5.2. Test Setup

Under 1GHz Test Setup:

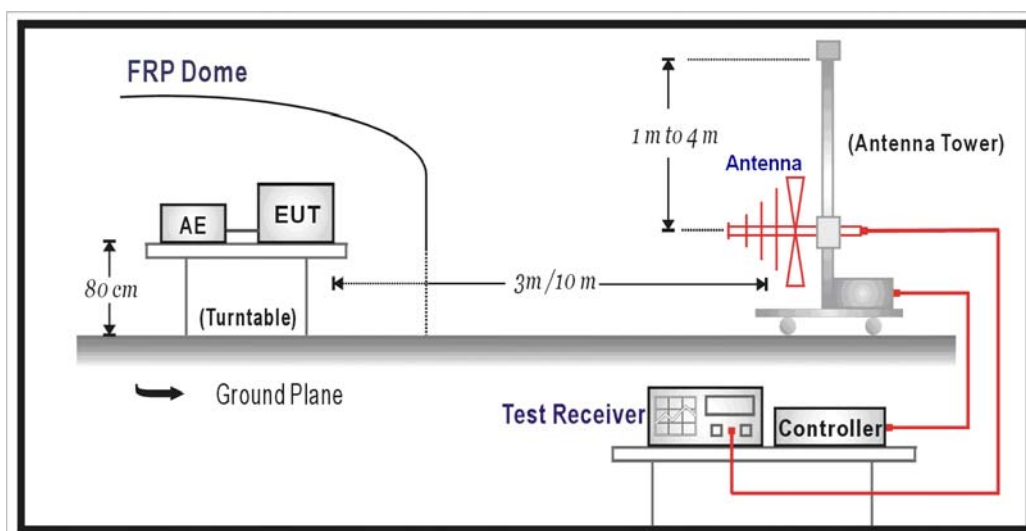

Above 1GHz Test Setup:

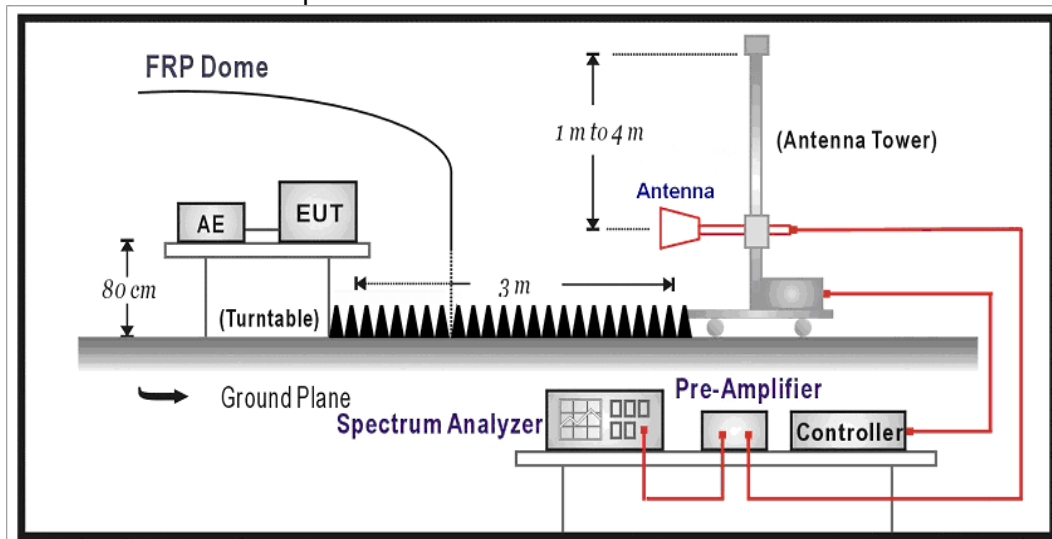

5.3. Limit

Limits		
Frequency MHz	Distance (m)	dBuV/m
30 – 230	10	40
230 – 1000	10	47

Limits			
Frequency (GHz)	Distance (m)	Peak (dBuV/m)	Average (dBuV/m)
1 – 3	3	76	56
3 – 6	3	80	60

Remark:

1. The tighter limit shall apply at the edge between two frequency bands.
2. Distance refers to the distance in meters between the measuring instrument antenna and the closed point of any part of the device or system.

Highest frequency generated or used in the device or on which the device operates or tunes (MHz)	Upper frequency of measurement range (MHz)
Below 108	1000
108 – 500	2000
500 – 1000	5000
Above 1000	5 th harmonic of the highest frequency or 6 GHz, whichever is lower

5.4. Test Procedure

The EUT and its simulators are placed on a turn table which is 0.8 meter above ground. The turn table can rotate 360 degrees to determine the position of the maximum emission level. The EUT was positioned such that the distance from antenna to the EUT was 3/10 meters. The antenna can move up and down between 1 meter and 4 meters to find out the maximum emission level.

Both horizontal and vertical polarization of the antenna are set on measurement. In order to find the maximum emission, all of the interface cables must be manipulated on radiated measurement.

Radiated emissions were investigated over the frequency range from 30MHz to 1GHz using a receiver bandwidth of 120kHz and above 1GHz using a receiver bandwidth of 1MHz.

30MHz to 1GHz Radiated was performed at an antenna to EUT distance of 10 meters.

Above 1GHz Radiated was performed at an antenna to EUT distance of 3 meters.

It is placed with absorb on the ground between EUT and Antenna.

5.5. Deviation from Test Standard

No deviation.

5.6. Test Result

Site : OATS-3	Time : 2011/03/09 - 11:32
Limit : CISPR_A_10M_QP	Margin : 6
EUT : Network Camera	Probe : Site3_CBL6112_10M_0811 - HORIZONTAL
Power : AC 230V/50Hz	Note : Mode 1

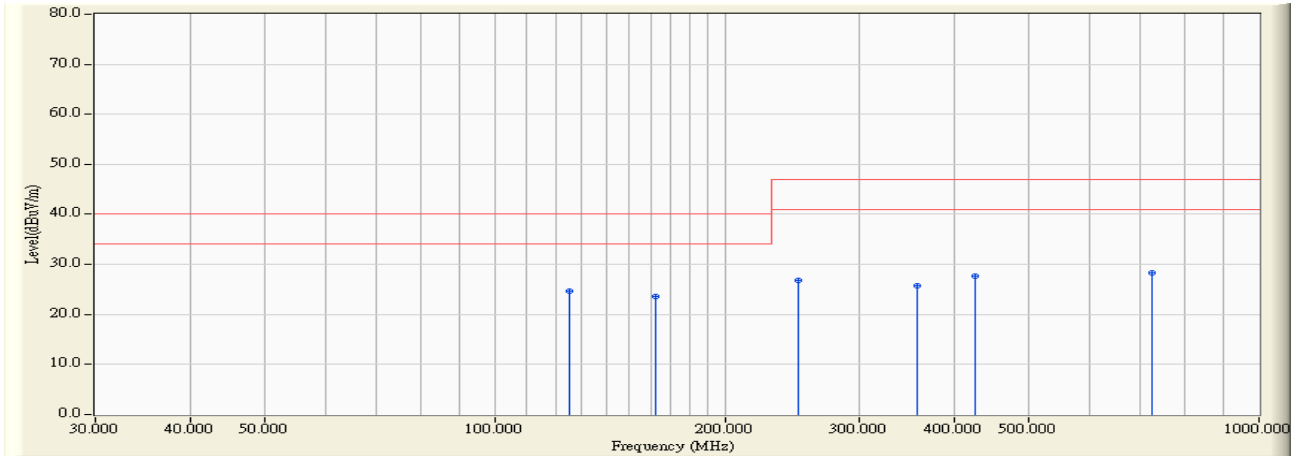

		Frequency (MHz)	Correct Factor (dB)	Reading Level (dBuV)	Measure Level (dBuV/m)	Margin (dB)	Limit (dBuV/m)	Detector Type
1	*	125.000	15.012	9.714	24.726	-15.274	40.000	QUASPEAK
2		162.000	13.128	10.567	23.695	-16.305	40.000	QUASPEAK
3		250.024	16.299	10.495	26.795	-20.205	47.000	QUASPEAK
4		356.401	18.915	6.900	25.815	-21.185	47.000	QUASPEAK
5		425.632	20.587	7.020	27.607	-19.393	47.000	QUASPEAK
6		725.026	25.240	3.139	28.379	-18.621	47.000	QUASPEAK

Note:

1. All Readings below 1GHz are Quasi-Peak, above are performed with peak and/or average measurements as necessary.
2. " * ", means this data is the worst emission level.
3. Measurement Level = Reading Level + Correct Factor

Site : OATS-3	Time : 2011/03/09 - 11:56
Limit : CISPR_A_10M_QP	Margin : 6
EUT : Network Camera	Probe : Site3_CBL6112_10M_0811 - VERTICAL
Power : AC 230V/50Hz	Note : Mode 1

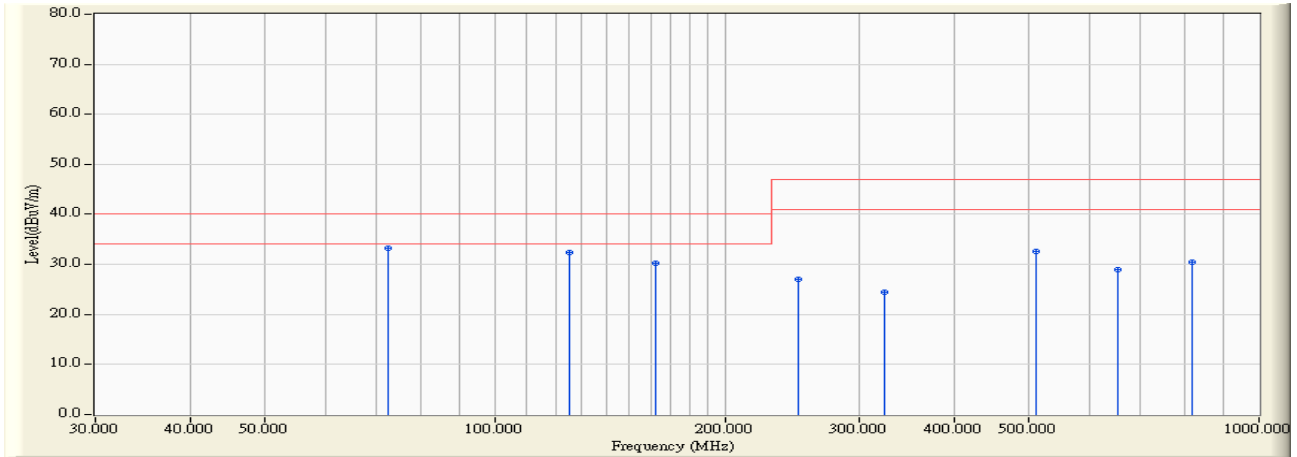

		Frequency (MHz)	Correct Factor (dB)	Reading Level (dBuV)	Measure Level (dBuV/m)	Margin (dB)	Limit (dBuV/m)	Detector Type
1	*	72.600	9.323	23.958	33.282	-6.718	40.000	QUASIPeAK
2		125.000	15.012	17.467	32.479	-7.521	40.000	QUASIPeAK
3		162.000	13.128	17.010	30.138	-9.862	40.000	QUASIPeAK
4		250.013	16.299	10.717	27.016	-19.984	47.000	QUASIPeAK
5		324.007	18.043	6.400	24.443	-22.557	47.000	QUASIPeAK
6		510.758	22.252	10.308	32.561	-14.439	47.000	QUASIPeAK
7		652.630	24.359	4.551	28.910	-18.090	47.000	QUASIPeAK
8		815.784	26.531	3.890	30.421	-16.579	47.000	QUASIPeAK

Note:

1. All Readings below 1GHz are Quasi-Peak, above are performed with peak and/or average measurements as necessary.
2. " * ", means this data is the worst emission level.
3. Measurement Level = Reading Level + Correct Factor

Site : 9x6x6_Chamber	Time : 2011/03/17 - 16:08
Limit : CISPR_22_A_(Above_1G)_03M_PK	Margin : 6
EUT : Network Camera	Probe : 9120D_1-18G_Horn - HORIZONTAL
Power : AC 230V/50Hz	Note : Mode 1

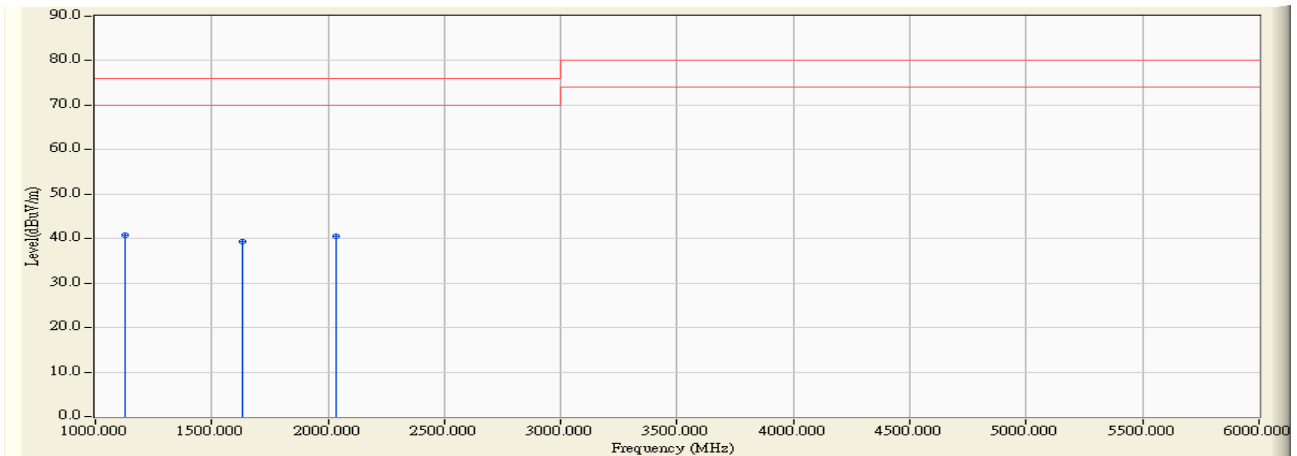

		Frequency (MHz)	Correct Factor (dB)	Reading Level (dBuV)	Measure Level (dBuV/m)	Margin (dB)	Limit (dBuV/m)	Detector Type
1	*	1125.000	-8.064	48.770	40.706	-35.294	76.000	PEAK
2		1633.000	-6.290	45.650	39.359	-36.641	76.000	PEAK
3		2033.000	-4.459	45.030	40.571	-35.429	76.000	PEAK

Note:

1. All Readings below 1GHz are Quasi-Peak, above are performed with peak and/or average measurements as necessary.
2. " * ", means this data is the worst emission level.
3. Measurement Level = Reading Level + Correct Factor

Site : 9x6x6_Chamber	Time : 2011/03/17 - 16:08
Limit : CISPR_22_A_(Above_1G)_03M_PK	Margin : 6
EUT : Network Camera	Probe : 9120D_1-18G_Horn - VERTICAL
Power : AC 230V/50Hz	Note : Mode 1

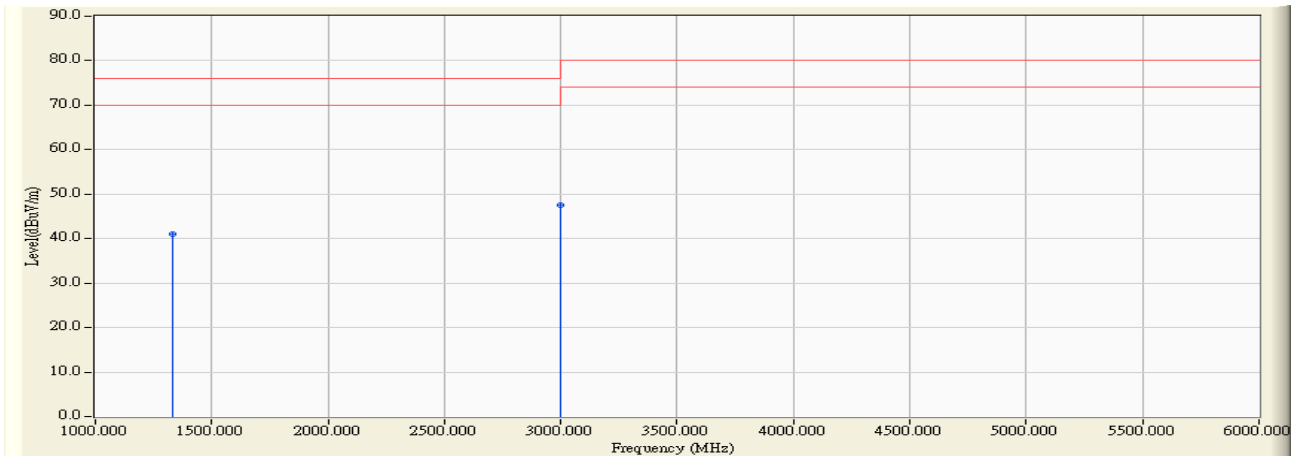

		Frequency (MHz)	Correct Factor (dB)	Reading Level (dBuV)	Measure Level (dBuV/m)	Margin (dB)	Limit (dBuV/m)	Detector Type
1		1333.000	-7.587	48.700	41.113	-34.887	76.000	PEAK
2	*	3000.000	-2.797	50.370	47.574	-28.426	76.000	PEAK

Note:

1. All Readings below 1GHz are Quasi-Peak, above are performed with peak and/or average measurements as necessary.
2. " * ", means this data is the worst emission level.
3. Measurement Level = Reading Level + Correct Factor

5.7. Test Photograph

Test Mode : Mode 1: Normal Operation

Description : Front View of Radiated Test



Test Mode : Mode 1: Normal Operation

Description : Back View of Radiated Test



Test Mode : Mode 1: Normal Operation

Description : Front View of High Frequency Radiated Test



6. Harmonic Current Emission

6.1. Test Specification

According to EMC Standard : EN 61000-3-2

6.2. Test Setup

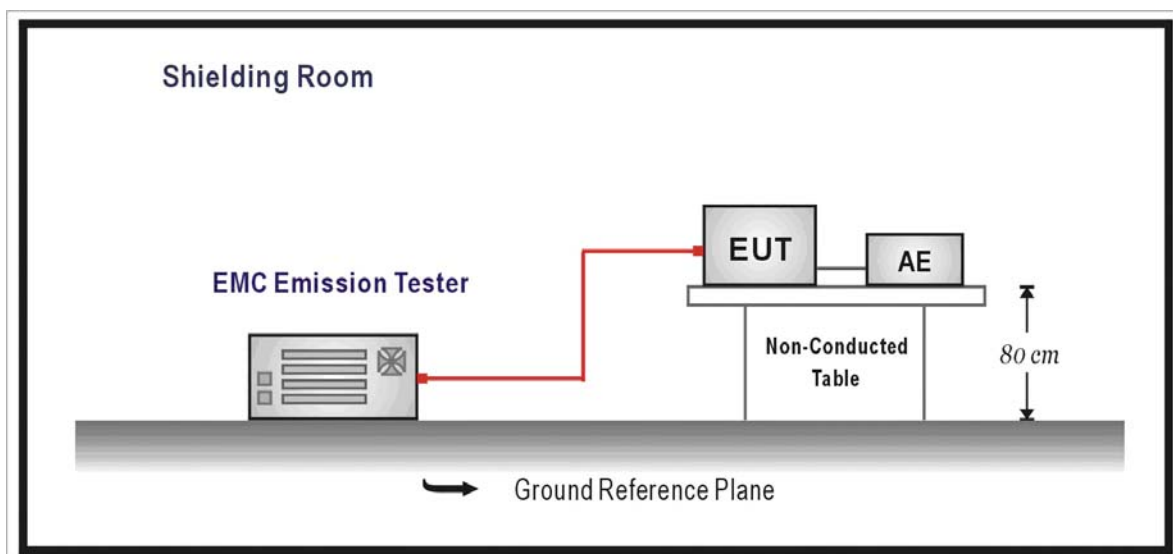

6.3. Limit

(a) Limits of Class A Harmonics Currents

Harmonics Order n	Maximum Permissible harmonic current A	Harmonics Order n	Maximum Permissible harmonic current A
Odd harmonics		Even harmonics	
3	2.30	2	1.08
5	1.14	4	0.43
7	0.77	6	0.30
9	0.40	8 ≤ n ≤ 40	0.23 * 8/n
11	0.33		
13	0.21		
15 ≤ n ≤ 39	0.15 * 15/n		

(b) Limits of Class B Harmonics Currents

For Class B equipment, the harmonic of the input current shall not exceed the maximum permissible values given in table that is the limit of Class A multiplied by a factor of 1.5.

(c) Limits of Class C Harmonics Currents

Harmonics Order n	Maximum Permissible harmonic current Expressed as a percentage of the input current at the fundamental frequency %
2	2
3	$30 \cdot \lambda^*$
5	10
7	7
9	5
$11 \leq n \leq 39$ (odd harmonics only)	3

* λ is the circuit power factor

(d) Limits of Class D Harmonics Currents

Harmonics Order n	Maximum Permissible harmonic current per watt mA/W	Maximum Permissible harmonic current A
3	3.4	2.30
5	1.9	1.14
7	1.0	0.77
9	0.5	0.40
11	0.35	0.33
$11 \leq n \leq 39$ (odd harmonics only)	$3.85/n$	See limit of Class A

6.4. Test Procedure

The EUT is supplied in series with power analyzer from a power source having the same normal voltage and frequency as the rated supply voltage and the equipment under test. And the rated voltage at the supply voltage of EUT of 0.94 times and 1.06 times shall be performed.

6.5. Deviation from Test Standard

No deviation.

6.6. Test Result

Product	Network Camera		
Test Item	Power Harmonics		
Test Mode	Mode 1: Normal Operation		
Date of Test	2011/03/15	Test Site	No.3 Shielded Room

Test Result: Pass Source qualification: Normal

Current & voltage waveforms

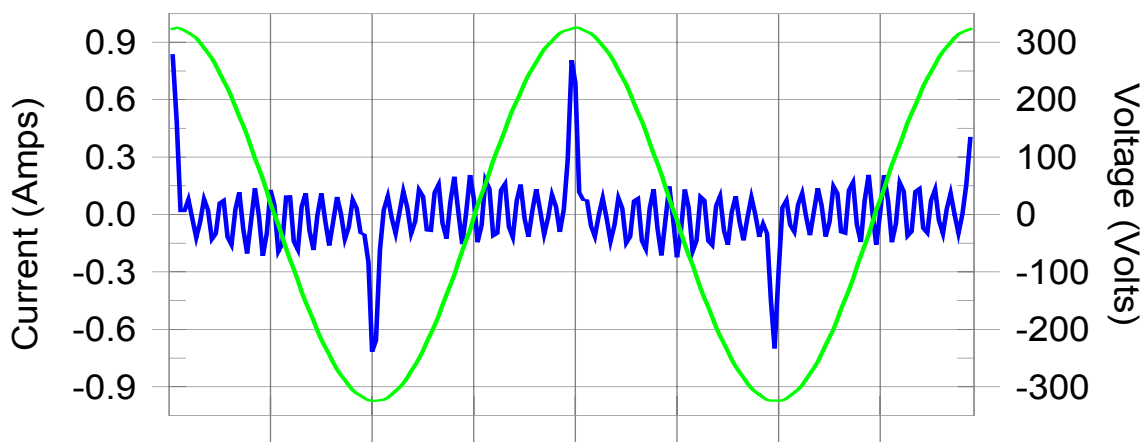

Harmonics and Class A limit line

European Limits

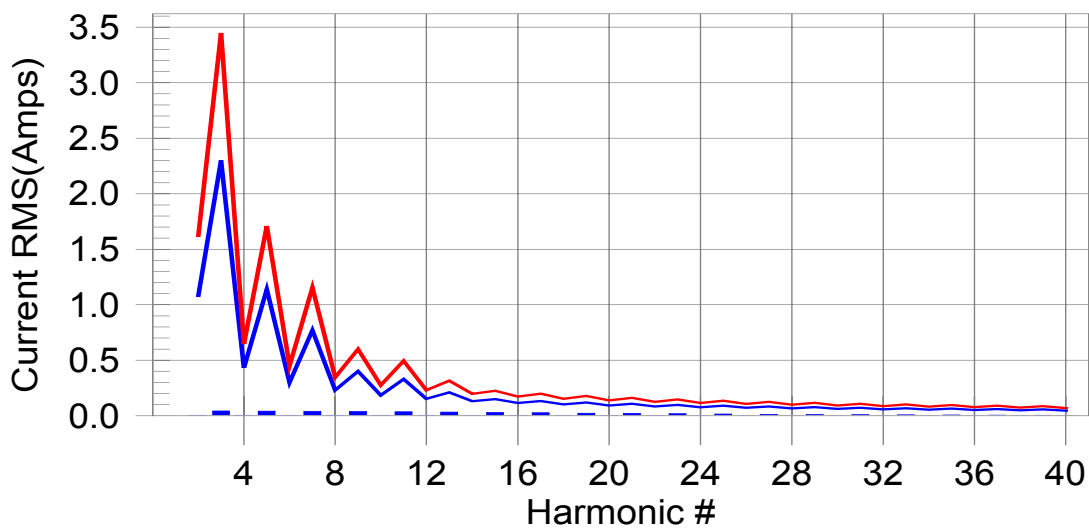

Test result: Pass Worst harmonic was #17 with 19.29% of the limit.

Test Result: Pass Source qualification: Normal
 THC(A): 0.11 I-THD(%): 223.33 POHC(A): 0.038 POHC Limit(A): 0.251
 Highest parameter values during test:

V_RMS (Volts):	229.65	Frequency(Hz):	50.00
I_Peak (Amps):	0.876	I_RMS (Amps):	0.171
I_Fund (Amps):	0.050	Crest Factor:	5.330
Power (Watts):	11.3	Power Factor:	0.288

Harm#	Harms(avg)	100%Limit	%of Limit	Harms(max)	150%Limit	%of Limit	Status
2	0.003	1.080	0.3	0.004	1.620	0.22	Pass
3	0.041	2.300	1.8	0.043	3.450	1.25	Pass
4	0.003	0.430	0.7	0.004	0.645	0.56	Pass
5	0.040	1.140	3.5	0.042	1.710	2.45	Pass
6	0.003	0.300	1.0	0.003	0.450	0.76	Pass
7	0.038	0.770	5.0	0.040	1.155	3.47	Pass
8	0.003	0.230	1.2	0.003	0.345	0.99	Pass
9	0.036	0.400	9.0	0.038	0.600	6.35	Pass
10	0.003	0.184	1.5	0.003	0.276	1.19	Pass
11	0.034	0.330	10.2	0.036	0.495	7.19	Pass
12	0.003	0.153	1.7	0.003	0.230	1.37	Pass
13	0.031	0.210	14.8	0.033	0.315	10.39	Pass
14	0.002	0.131	1.9	0.003	0.197	1.52	Pass
15	0.028	0.150	18.9	0.030	0.225	13.25	Pass
16	0.002	0.115	2.0	0.003	0.173	1.62	Pass
17	0.025	0.132	19.3	0.027	0.199	13.46	Pass
18	0.002	0.102	2.1	0.003	0.153	1.69	Pass
19	0.023	0.118	19.1	0.024	0.178	13.35	Pass
20	0.002	0.092	2.2	0.002	0.138	1.75	Pass
21	0.020	0.107	18.5	0.021	0.161	12.92	Pass
22	0.002	0.084	2.2	0.002	0.125	1.77	Pass
23	0.017	0.098	17.6	0.018	0.147	12.30	Pass
24	0.002	0.077	2.1	0.002	0.115	1.74	Pass
25	0.015	0.090	16.4	0.015	0.135	11.45	Pass
26	0.001	0.071	2.0	0.002	0.106	1.70	Pass
27	0.013	0.083	15.1	0.013	0.125	10.58	Pass
28	0.001	0.066	1.9	0.002	0.099	1.64	Pass
29	0.011	0.078	13.7	0.011	0.116	9.60	Pass
30	0.001	0.061	1.8	0.001	0.092	1.58	Pass
31	0.009	0.073	12.4	0.009	0.109	8.65	Pass
32	0.001	0.058	1.7	0.001	0.086	1.45	Pass
33	0.008	0.068	11.2	0.008	0.102	7.80	Pass
34	0.001	0.054	1.5	0.001	0.081	1.34	Pass
35	0.006	0.064	10.1	0.007	0.096	7.00	Pass
36	0.001	0.051	1.4	0.001	0.077	1.24	Pass
37	0.005	0.061	9.0	0.006	0.091	6.21	Pass
38	0.001	0.048	1.2	0.001	0.073	1.13	Pass
39	0.005	0.058	8.2	0.005	0.087	5.56	Pass
40	0.001	0.046	1.1	0.001	0.069	1.01	Pass

1.Dynamic limits were applied for this test. The highest harmonics values in the above table may not occur at the same window as the maximum harmonics/limit ratio.

2:According to EN61000-3-2 paragraph 7 the note 1 and 2 are valid for all applications having an active input power >75W. Others the result should be pass.

6.7. Test Photograph

Test Mode : Mode 1: Normal Operation

Description : Power Harmonics Test Setup



7. Voltage Fluctuation and Flicker

7.1. Test Specification

According to EMC Standard : EN 61000-3-3

7.2. Test Setup

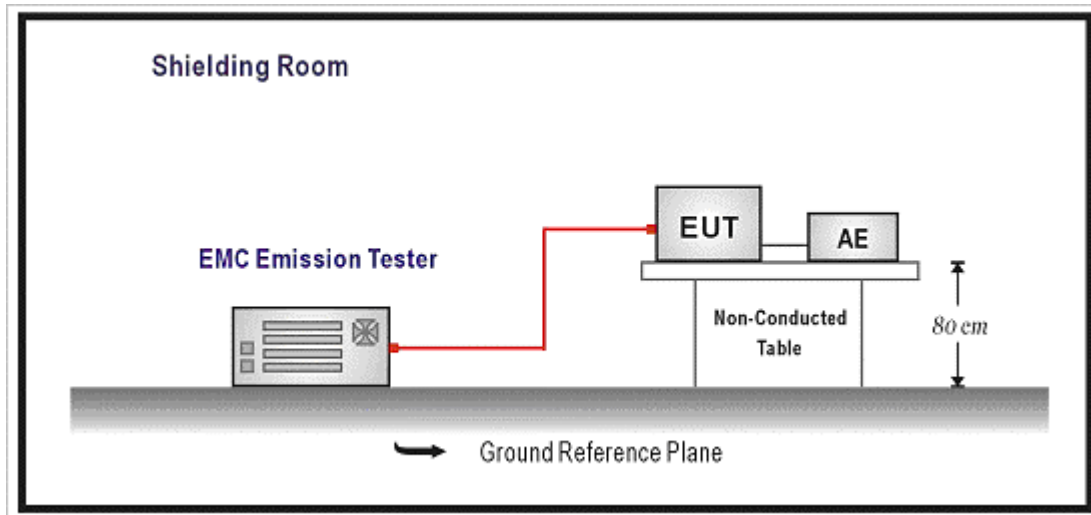

7.3. Limit

The following limits apply:

- the value of P_{st} shall not be greater than 1.0;
- the value of P_{1t} shall not be greater than 0.65;
- the value of $d(t)$ during a voltage change shall not exceed 3.3 % for more than 500 ms;
- the relative steady-state voltage change, d_c , shall not exceed 3.3 %;
- the maximum relative voltage change, d_{max} , shall not exceed;
 - a) 4 % without additional conditions;
 - b) 6 % for equipment which is:
 - switched manually, or
 - switched automatically more frequently than twice per day, and also has either a delayed restart (the delay being not less than a few tens of seconds), or manual restart, after a power supply interruption.

NOTE The cycling frequency will be further limited by the P_{st} and P_{1t} limit.

For example: a d_{max} of 6% producing a rectangular voltage change characteristic twice per hour will give a P_{1t} of about 0.65.

- c) 7 % for equipment which is:
- attended whilst in use (for example: hair dryers, vacuum cleaners, kitchen equipment such as mixers, garden equipment such as lawn mowers, portable tools such as electric drills), or
 - switched on automatically, or is intended to be switched on manually, no more than twice per day, and also has either a delayed restart (the delay being not less than a few tens of seconds) or manual restart, after a power supply interruption.

P_{st} and P_{1t} requirements shall not be applied to voltage changes caused by manual switching.

7.4. Test Procedure

The EUT is supplied in series with power analyzer from a power source having the same normal voltage and frequency as the rated supply voltage and the equipment under test. And the rated voltage at the supply voltage of EUT of 0.94 times and 1.06 times shall be performed.

7.5. Deviation from Test Standard

No deviation.

7.6. Test Result

Product	Network Camera		
Test Item	Voltage Fluctuation and Flicker		
Test Mode	Mode 1: Normal Operation		
Date of Test	2011/03/15	Test Site	No.3 Shielded Room

Test Result: Pass

Status: Test Completed

Pstj and limit line

European Limits

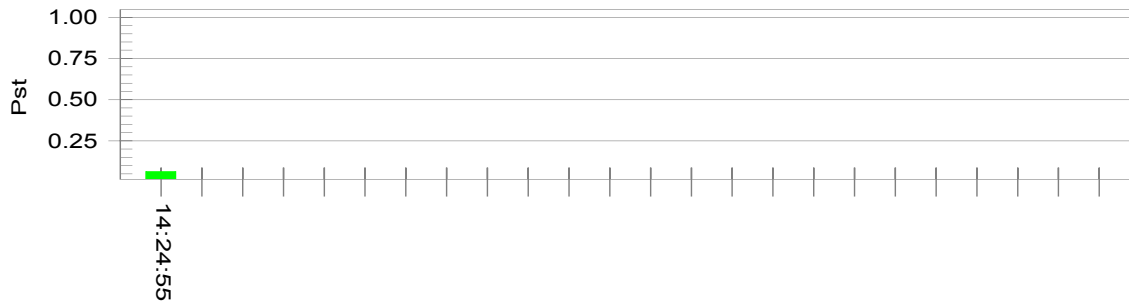

Plt and limit line



Parameter values recorded during the test:

Vrms at the end of test (Volt):	229.57			
Highest dt (%):	0.00	Test limit (%):	3.30	Pass
Time(mS) > dt:	0.0	Test limit (mS):	500.0	Pass
Highest dc (%):	0.00	Test limit (%):	3.30	Pass
Highest dmax (%):	0.00	Test limit (%):	4.00	Pass
Highest Pst (10 min. period):	0.064	Test limit:	1.000	Pass
Highest Plt (2 hr. period):	0.028	Test limit:	0.650	Pass

7.7. Test Photograph

Test Mode : Mode 1: Normal Operation

Description : Flicker Test Setup



8. Electrostatic Discharge

8.1. Test Specification

According to Standard : IEC 61000-4-2

8.2. Test Setup

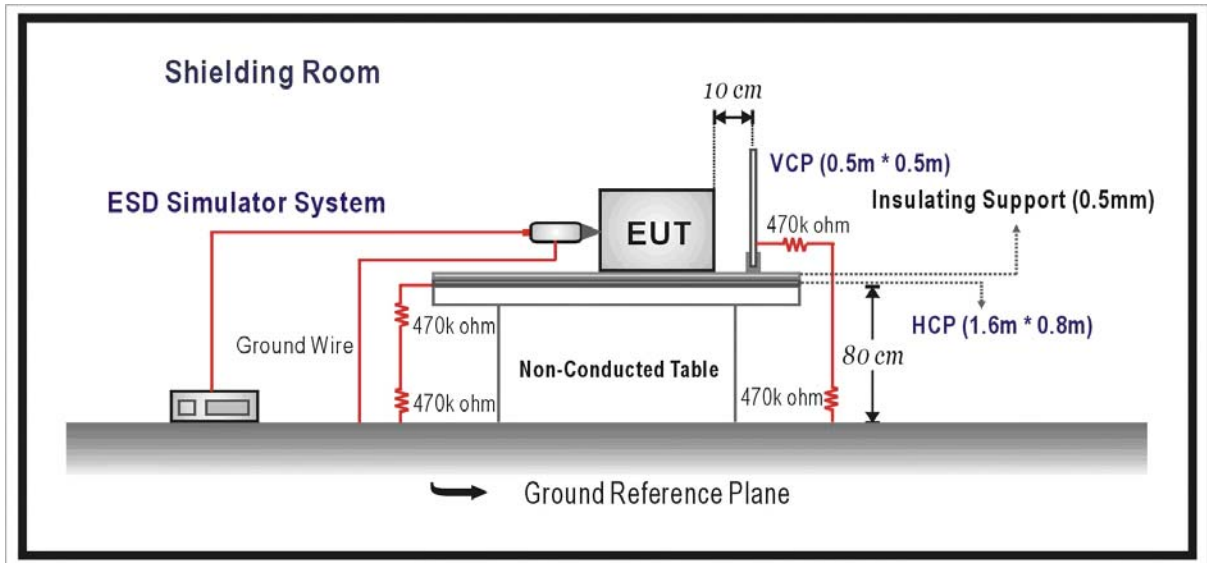

8.3. Limit

Item	Environmental Phenomena	Units	Test Specification	Performance Criteria
Enclosure Port				
	Electrostatic Discharge	kV(Charge Voltage)	±8 Air Discharge ±4 Contact Discharge	B

8.4. Test Procedure

Direct application of discharges to the EUT:

Contact discharge was applied only to conductive surfaces of the EUT.

Air discharges were applied only to non-conductive surfaces of the EUT.

During the test, it was performed with single discharges. For the single discharge time between successive single discharges will be keep longer 1 second. It was at least ten single discharges with positive and negative at the same selected point.

The selected point, which was performed with electrostatic discharge, was marked on the red label of the EUT.

Indirect application of discharges to the EUT:

Vertical Coupling Plane (VCP):

The coupling plane, of dimensions 0.5m x 0.5m, is placed parallel to, and positioned at a distance 0.1m from, the EUT, with the Discharge Electrode touching the coupling plane.

The four faces of the EUT will be performed with electrostatic discharge. It was at least ten single discharges with positive and negative at the same selected point.

Horizontal Coupling Plane (HCP):

The coupling plane is placed under to the EUT. The generator shall be positioned vertically at a distance of 0.1m from the EUT, with the Discharge Electrode touching the coupling plane.

The four faces of the EUT will be performed with electrostatic discharge. It was at least ten single discharges with positive and negative at the same selected point.

8.5. Deviation from Test Standard

No deviation.

8.6. Test Result

Product	Network Camera		
Test Item	Electrostatic Discharge		
Test Mode	Mode 1: Normal Operation		
Date of Test	2011/03/16	Test Site	No.6 Shielded Room

Item	Amount of Discharge	Voltage	Required Criteria	Complied To Criteria (A,B,C)	Results
Air Discharge	10	+8kV	B	A	Pass
	10	-8kV	B	A	Pass
Contact Discharge	25	+4kV	B	A	Pass
	25	-4kV	B	A	Pass
Indirect Discharge (HCP)	25	+4kV	B	A	Pass
	25	-4kV	B	A	Pass
Indirect Discharge (VCP Front)	25	+4kV	B	A	Pass
	25	-4kV	B	A	Pass
Indirect Discharge (VCP Left)	25	+4kV	B	A	Pass
	25	-4kV	B	A	Pass
Indirect Discharge (VCP Back)	25	+4kV	B	A	Pass
	25	-4kV	B	A	Pass
Indirect Discharge (VCP Right)	25	+4kV	B	A	Pass
	25	-4kV	B	A	Pass

Note:

The testing performed is from lowest level up to the highest level as required by standard, but only highest level is shown on the report.

NR: No Requirement

- Meet criteria A: Operate as intended during and after the test
- Meet criteria B: Operate as intended after the test
- Meet criteria C: Loss/Error of function
- Additional Information
 - EUT stopped operation and could / could not be reset by operator at ____ kV.
 - No false alarms or other malfunctions were observed during or after the test.

Remark:

The Contact discharges were applied at least total 200 discharges at a minimum of four test points.

8.7. Test Photograph

Test Mode : Mode 1: Normal Operation

Description : ESD Test Setup



9. Radiated Susceptibility

9.1. Test Specification

According to Standard : IEC 61000-4-3

9.2. Test Setup

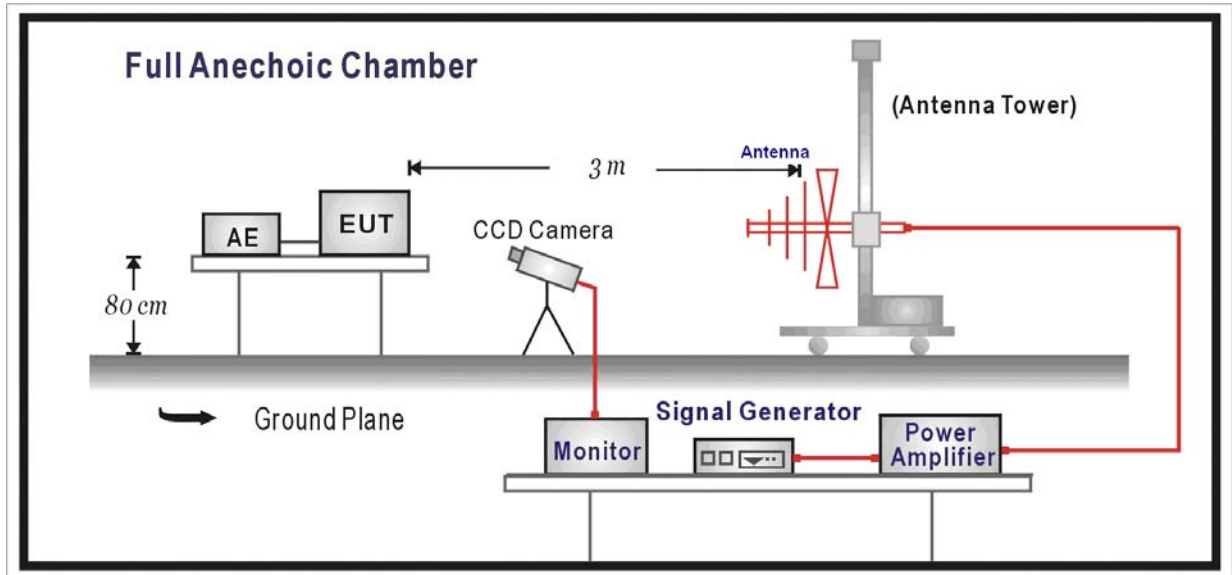

9.3. Limit

Item	Environmental Phenomena	Units	Test Specification	Performance Criteria
Enclosure Port				
	Radio-Frequency	MHz	80-1000	A
	Electromagnetic Field	V/m(Un-modulated, rms)	3	
	Amplitude Modulated	% AM (1kHz)	80	

9.4. Test Procedure

The EUT and load, which are placed on a table that is 0.8 meter above ground, are placed with one coincident with the calibration plane such that the distance from antenna to the EUT was 3 meters.

Both horizontal and vertical polarization of the antenna and four sides of the EUT are set on measurement.

In order to judge the EUT performance, a CCD camera is used to monitor EUT screen.

All the scanning conditions are as follows:

Condition of Test	Remarks
1. Field Strength	3 V/m Level 2
2. Radiated Signal	AM 80% Modulated with 1kHz
3. Scanning Frequency	80MHz - 1000MHz
4. Dwell Time	3 Seconds
5. Frequency step size Δf :	1%
6. The rate of Swept of Frequency	1.5×10^{-3} decades/s

9.5. Deviation from Test Standard

No deviation.

9.6. Test Result

Product	Network Camera		
Test Item	Radiated susceptibility		
Test Mode	Mode 1: Normal Operation		
Date of Test	2011/03/16	Test Site	Chamber5

Frequency (MHz)	Position (Angle)	Polarity (H or V)	Field Strength (V/m)	Required Criteria	Complied To Criteria (A, B, C)	Results
80-1000	FRONT	H	3	A	A	PASS
80-1000	FRONT	V	3	A	A	PASS
80-1000	BACK	H	3	A	A	PASS
80-1000	BACK	V	3	A	A	PASS
80-1000	RIGHT	H	3	A	A	PASS
80-1000	RIGHT	V	3	A	A	PASS
80-1000	LEFT	H	3	A	A	PASS
80-1000	LEFT	V	3	A	A	PASS
80-1000	UP	H	3	A	A	PASS
80-1000	UP	V	3	A	A	PASS
80-1000	DOWN	H	3	A	A	PASS
80-1000	DOWN	V	3	A	A	PASS

Note:

The testing performed is from lowest level up to the highest level as required by standard, but only highest level is shown on the report.

- Meet criteria A: Operate as intended during and after the test
- Meet criteria B: Operate as intended after the test
- Meet criteria C: Loss/Error of function
- Additional Information
 - There was no observable degradation in performance.
 - EUT stopped operation and could / could not be reset by operator at _____ V/m at frequency _____ MHz.
- No false alarms or other malfunctions were observed during or after the test.

9.7. Test Photograph

Test Mode : Mode 1: Normal Operation

Description : Radiated Susceptibility Test Setup



10. Electrical Fast Transient/Burst

10.1. Test Specification

According to Standard : IEC 61000-4-4

10.2. Test Setup

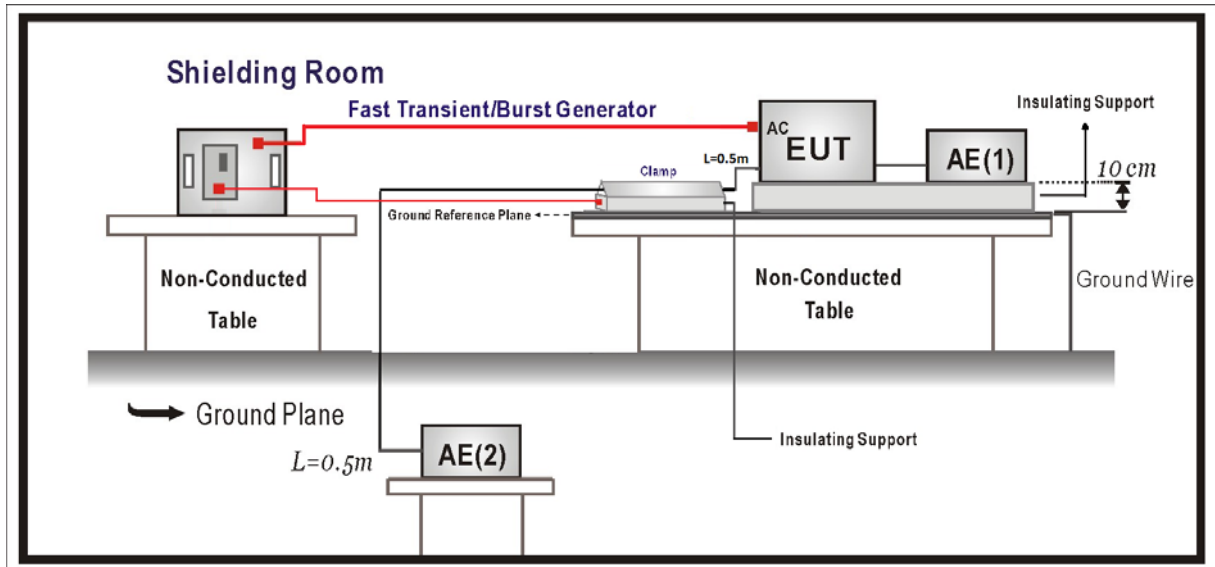

10.3. Limit

Item	Environmental Phenomena	Units	Test Specification	Performance Criteria
I/O and communication ports				
	Fast Transients Common Mode	kV (Peak) Tr/Th ns Rep. Frequency kHz	+0.5 5/50 5	B
Input DC Power Ports				
	Fast Transients Common Mode	kV (Peak) Tr/Th ns Rep. Frequency kHz	+0.5 5/50 5	B
Input AC Power Ports				
	Fast Transients Common Mode	kV (Peak) Tr/Th ns Rep. Frequency kHz	+1 5/50 5	B

10.4. Test Procedure

The EUT is placed on a table that is 0.8 meter height. A ground reference plane is placed on the table, and uses a 0.1m insulation between the EUT and ground reference plane.

The minimum area of the ground reference plane is 1m*1m, and 0.65mm thick min, and projected beyond the EUT by at least 0.1m on all sides.

Test on I/O and communication ports:

The EFT interference signal is through a coupling clamp device couples to the signal and control lines of the EUT with burst noise for 1minute.

Test on power supply ports:

The EUT is connected to the power mains through a coupling device that directly couples the EFT/B interference signal.

Each of the Line and Neutral conductors is impressed with burst noise for 1 minute.

The length of the signal and power lines between the coupling device and the EUT is 0.5m.

10.5. Deviation from Test Standard

No deviation.

10.6. Test Result

Product	Network Camera		
Test Item	Electrical fast transient/burst		
Test Mode	Mode 1: Normal Operation		
Date of Test	2011/03/16	Test Site	No.3 Shielded Room

Inject Line	Polarity	Voltage kV	Inject Time (Second)	Inject Method	Required Criteria	Complied to Criteria	Result
L+N+PE	±	1kV	60	Direct	B	A	PASS
LAN	±	0.5kV	60	Clamp	B	A	PASS

Note:

The testing performed is from lowest level up to the highest level as required by standard, but only highest level is shown on the report.

- Meet criteria A : Operate as intended during and after the test
- Meet criteria B : Operate as intended after the test
- Meet criteria C : Loss/Error of function
- Additional Information
 - EUT stopped operation and could / could not be reset by operator at _____ kV of Line _____.
- No false alarms or other malfunctions were observed during or after the test.

10.7. Test Photograph

Test Mode : Mode 1: Normal Operation

Description : EFT/B Test Setup



Test Mode : Mode 1: Normal Operation

Description : EFT/B Test Setup-Clamp



11. Surge

11.1. Test Specification

According to Standard : IEC 61000-4-5

11.2. Test Setup

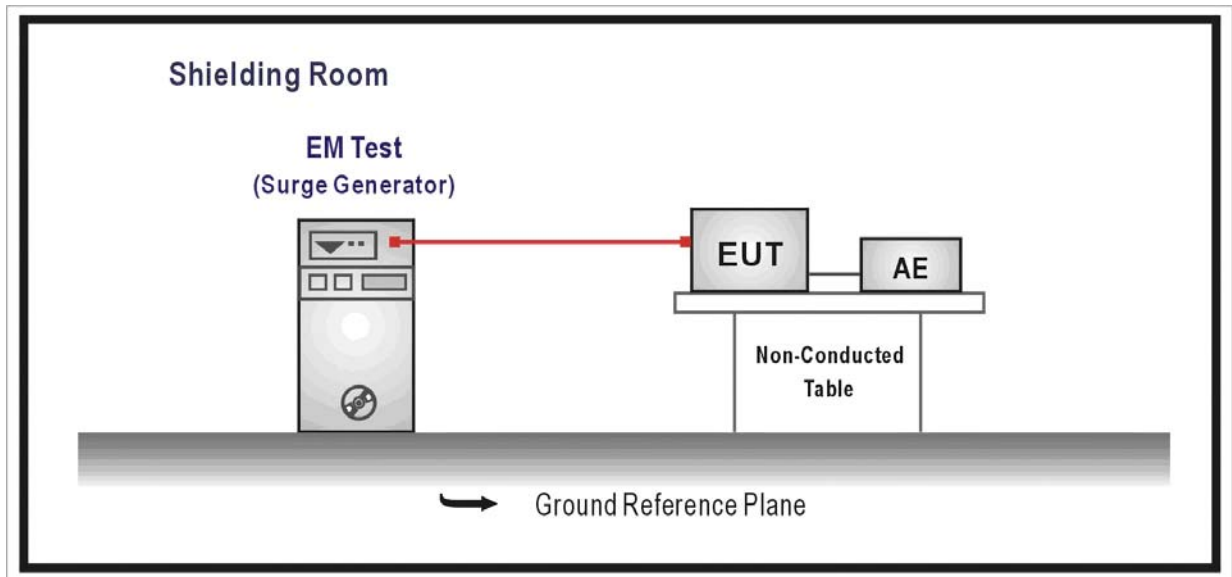

11.3. Limit

Item	Environmental Phenomena	Units	Test Specification	Performance Criteria
Signal Ports and Telecommunication Ports(See 1) and 2))				
	Surges Line to Ground	Tr/Th us kV	1.2/50 (8/20) ± 1	B
Input DC Power Ports				
	Surges Line to Ground	Tr/Th us kV	1.2/50 (8/20) ± 0.5	B
AC Input and AC Output Power Ports				
	Surges Line to Line Line to Ground	Tr/Th us kV kV	1.2/50 (8/20) ± 1 ± 2	B

Notes:

- 1) Applicable only to ports which according to the manufacturer’s may directly to outdoor cables.
- 2) Where normal functioning cannot be achieved because of the impact of the CDN on the EUT, no immunity test shall be required.

11.4. Test Procedure

The EUT and its load are placed on a table that is 0.8 meter above a metal ground plane measured 1m*1m min. and 0.65mm thick min. And projected beyond the EUT by at least 0.1m on all sides. The length of power cord between the coupling device and the EUT shall be 2m or less.

For Input and Output AC Power or DC Input and DC Output Power Ports:

The EUT is connected to the power mains through a coupling device that directly couples the Surge interference signal.

The surge noise shall be applied synchronized to the voltage phase at 0⁰, 90⁰, 180⁰, 270⁰ and the peak value of the a.c. voltage wave. (Positive and negative)

Each of Line-Earth and Line-Line is impressed with a sequence of five surge voltages with interval of 1 min.

11.5. Deviation from Test Standard

No deviation.

11.6. Test Result

Product	Network Camera		
Test Item	Surge		
Test Mode	Mode 1: Normal Operation		
Date of Test	2011/03/16	Test Site	No.3 Shielded Room

Inject Line	Polarity	Angle	Voltage kV	Time Interval (Second)	Inject Method	Required Criteria	Complied to Criteria	Result
L-N	±	0	1kV	60	Direct	B	A	PASS
L-N	±	90	1kV	60	Direct	B	A	PASS
L-N	±	180	1kV	60	Direct	B	A	PASS
L-N	±	270	1kV	60	Direct	B	A	PASS
L-PE	±	0	2kV	60	Direct	B	A	PASS
L-PE	±	90	2kV	60	Direct	B	A	PASS
L-PE	±	180	2kV	60	Direct	B	A	PASS
L-PE	±	270	2kV	60	Direct	B	A	PASS
N-PE	±	0	2kV	60	Direct	B	A	PASS
N-PE	±	90	2kV	60	Direct	B	A	PASS
N-PE	±	180	2kV	60	Direct	B	A	PASS
N-PE	±	270	2kV	60	Direct	B	A	PASS

Note:

The testing performed is from lowest level up to the highest level as required by standard, but only highest level is shown on the report.

- Meet criteria A : Operate as intended during and after the test
- Meet criteria B : Operate as intended after the test
- Meet criteria C : Loss/Error of function
- Additional Information
 - EUT stopped operation and could / could not be reset by operator at _____ kV of Line _____.
- No false alarms or other malfunctions were observed during or after the test.

11.7. Test Photograph

Test Mode : Mode 1: Normal Operation

Description : SURGE Test Setup



12. Conducted Susceptibility

12.1. Test Specification

According to Standard : IEC 61000-4-6

12.2. Test Setup

CDN Test Mode

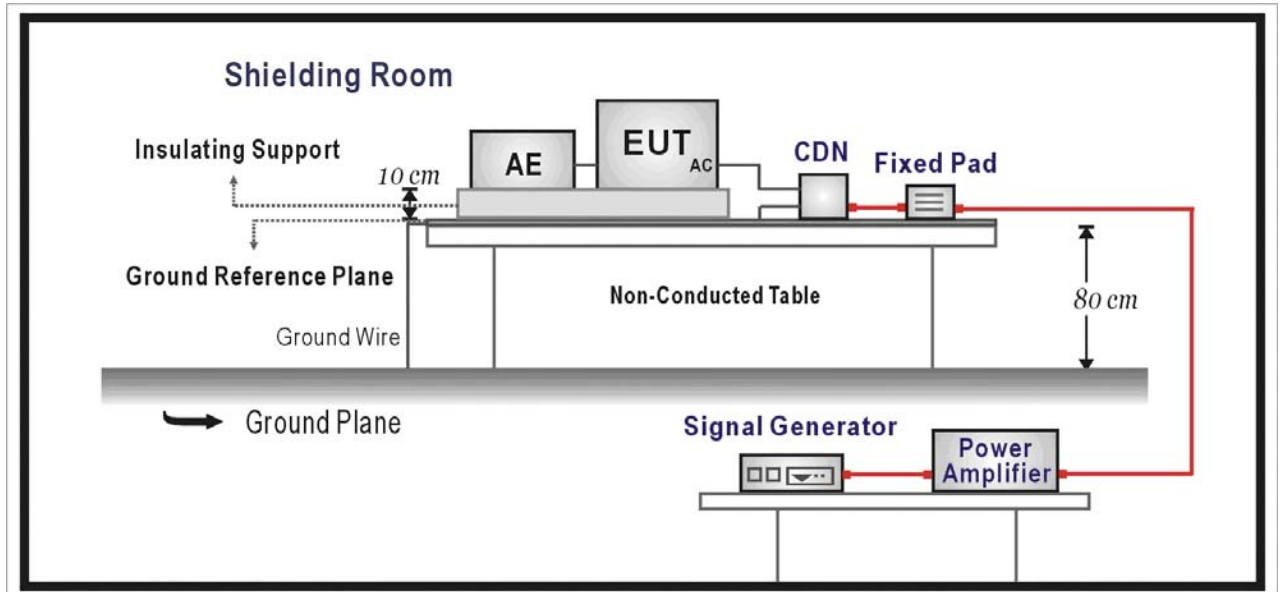

EM Clamp Test Mode

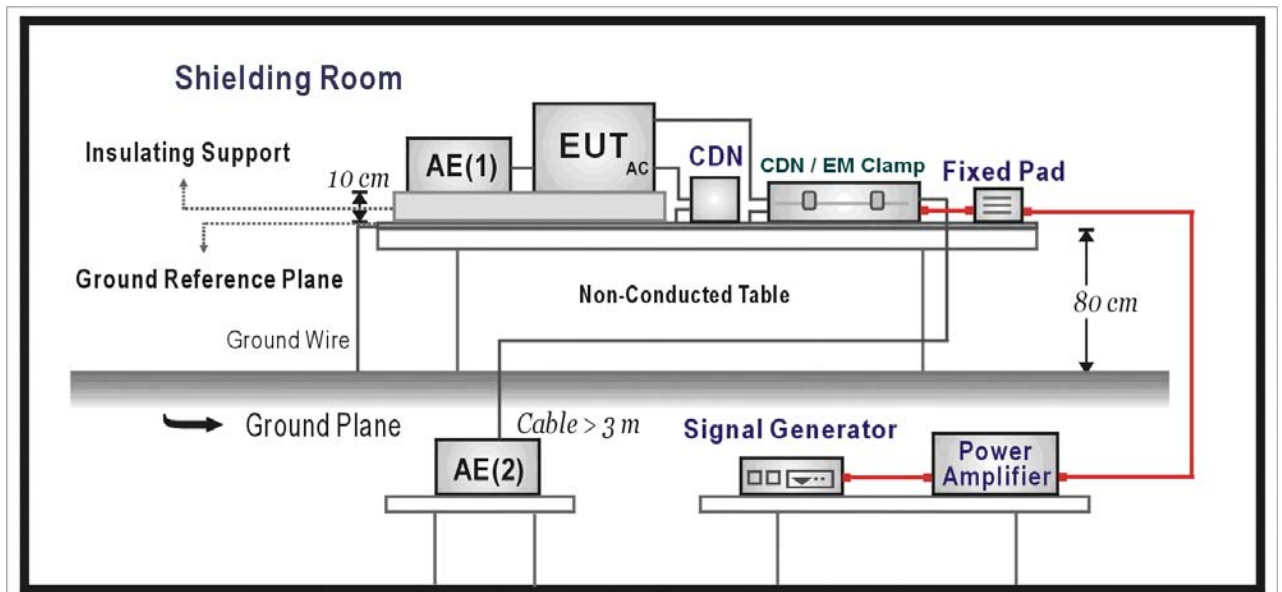

12.3. Limit

Item	Environmental Phenomena	Units	Test Specification	Performance Criteria
Signal Ports and Telecommunication Ports				
	Radio-Frequency Continuous Conducted	MHz V (rms, Un-modulated) % AM (1kHz)	0.15-80 3 80	A
Input DC Power Ports				
	Radio-Frequency Continuous Conducted	MHz V (rms, Un-modulated) % AM (1kHz)	0.15-80 3 80	A
Input AC Power Ports				
	Radio-Frequency Continuous Conducted	MHz V (rms, Un-modulated) % AM (1kHz)	0.15-80 3 80	A

12.4. Test Procedure

The EUT are placed on a table that is 0.8 meter height, and a Ground reference plane on the table, EUT are placed upon table and use a 10cm insulation between the EUT and Ground reference plane.

For Signal Ports and Telecommunication Ports

The disturbance signal is through a coupling and decoupling networks (CDN) or EM-clamp device couples to the signal and Telecommunication lines of the EUT.

For Input DC and AC Power Ports

The EUT is connected to the power mains through a coupling and decoupling networks for power supply lines. And directly couples the disturbances signal into EUT.

Used CDN-M2 for two wires or CDN-M3 for three wires.

All the scanning conditions are as follows:

Condition of Test	Remarks
1. Field Strength	130dBuV(3V) Level 2
2. Radiated Signal	AM 80% Modulated with 1kHz
3. Scanning Frequency	0.15MHz – 80MHz
4. Dwell Time	3 Seconds
5. Frequency step size Δf :	1%
6. The rate of Swept of Frequency	1.5×10^{-3} decades/s

12.5. Deviation from Test Standard

No deviation.

12.6. Test Result

Product	Network Camera		
Test Item	Conducted susceptibility		
Test Mode	Mode 1: Normal Operation		
Date of Test	2011/03/16	Test Site	No.6 Shielded Room

Frequency Range (MHz)	Voltage Applied dBuV(V)	Inject Method	Tested Port of EUT	Required Criteria	Performance Criteria Complied To	Result
0.15~80	130 (3V)	CDN	AC IN	A	A	PASS
0.15~80	130 (3V)	CDN	LAN	A	A	PASS

Note:

The testing performed is from lowest level up to the highest level as required by standard, but only highest level is shown on the report.

- Meet criteria A : Operate as intended during and after the test
- Meet criteria B : Operate as intended after the test
- Meet criteria C : Loss/Error of function
- Additional Information
 - EUT stopped operation and could / could not be reset by operator at _____ dBuV(V) at frequency _____MHz.
 - No false alarms or other malfunctions were observed during or after the test. The acceptance criteria were met, and the EUT passed the test.

12.7. Test Photograph

Test Mode : Mode 1: Normal Operation

Description : Conducted Susceptibility Test Setup



Test Mode : Mode 1: Normal Operation

Description : Conducted Susceptibility Test Setup-CDN



13. Power Frequency Magnetic Field

13.1. Test Specification

According to Standard : IEC 61000-4-8

13.2. Test Setup

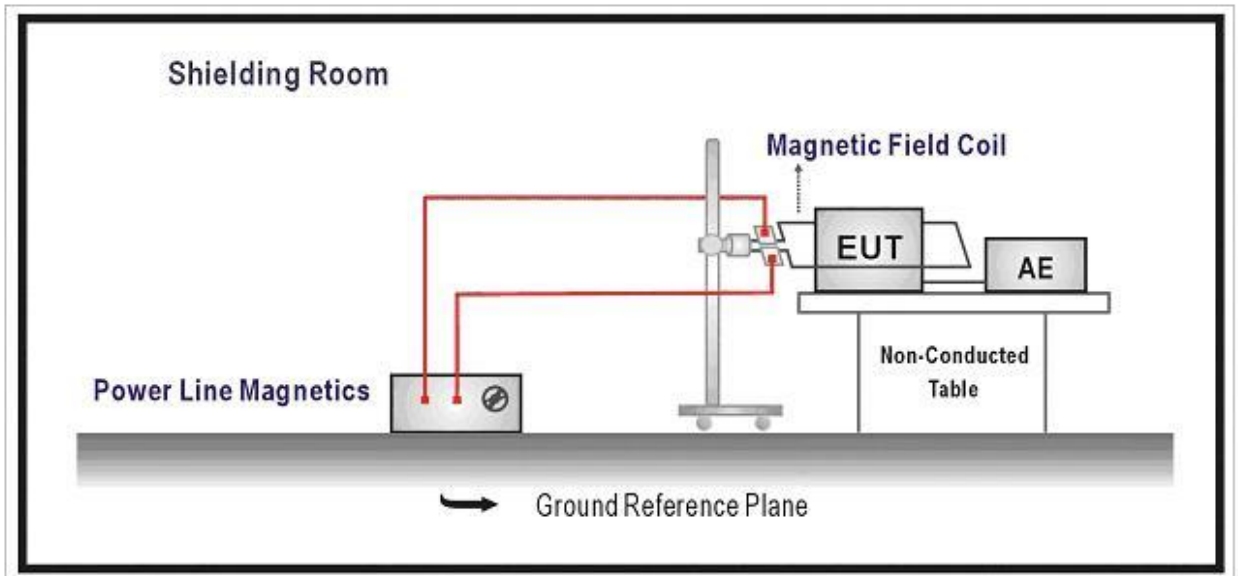

13.3. Limit

Item	Environmental Phenomena	Units	Test Specification	Performance Criteria
Enclosure Port				
	Power-Frequency Magnetic Field	Hz A/m (r.m.s.)	50 1	A

13.4. Test Procedure

The EUT and its load are placed on a table which is 0.8 meter above a metal ground plane measured at least 1m*1m min. The test magnetic field shall be placed at central of the induction coil.

The test magnetic Field shall be applied 10 minutes by the immersion method to the EUT. And the induction coil shall be rotated by 90° in order to expose the EUT to the test field with different orientation (X, Y, Z Orientations).

13.5. Deviation from Test Standard

No deviation.

13.6. Test Result

Product	Network Camera		
Test Item	Power frequency magnetic field		
Test Mode	Mode 1: Normal Operation		
Date of Test	2011/03/16	Test Site	No.3 Shielded Room

Polarization	Frequency (Hz)	Magnetic Strength (A/m)	Required Performance Criteria	Performance Criteria Complied To	Test Result
X Orientation	50	1	A	A	PASS
Y Orientation	50	1	A	A	PASS
Z Orientation	50	1	A	A	PASS

- Meet criteria A: Operate as intended during and after the test
- Meet criteria B: Operate as intended after the test
- Meet criteria C: Loss/Error of function
- Additional Information
 - EUT stopped operation and could / could not be reset by operator at _____ kV of Line _____.
- No false alarms or other malfunctions were observed during or after the test. The acceptance criteria were met, and the EUT passed the test.

13.7. Test Photograph

Test Mode : Mode 1: Normal Operation

Description : Power Frequency Magnetic Field Test Setup

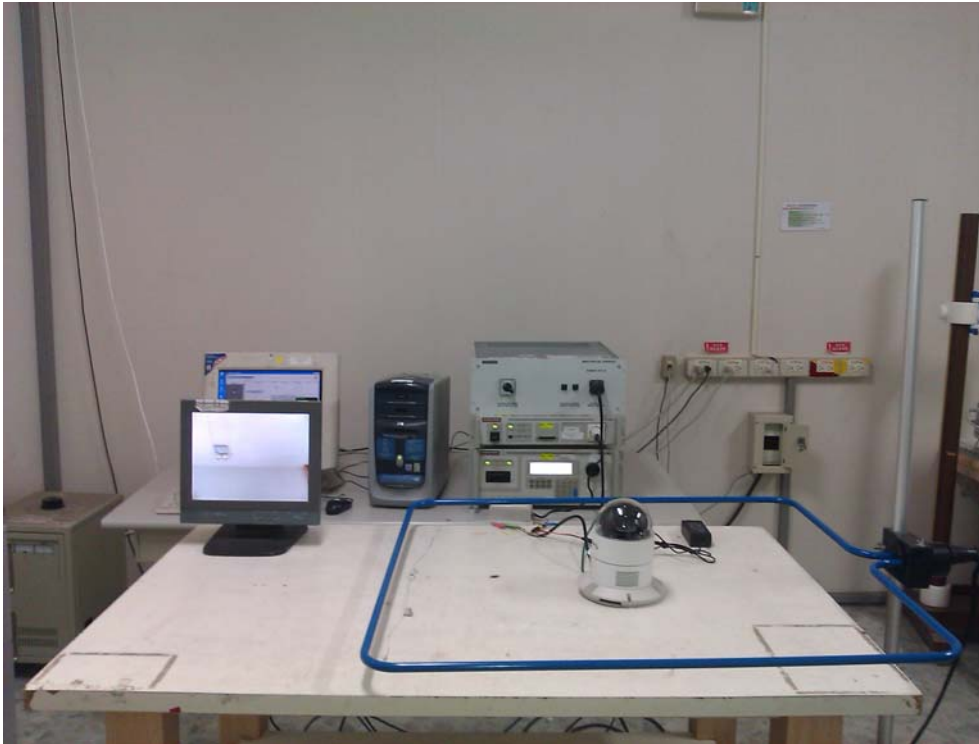

14. Voltage Dips and Interruption

14.1. Test Specification

According to Standard : IEC 61000-4-11

14.2. Test Setup

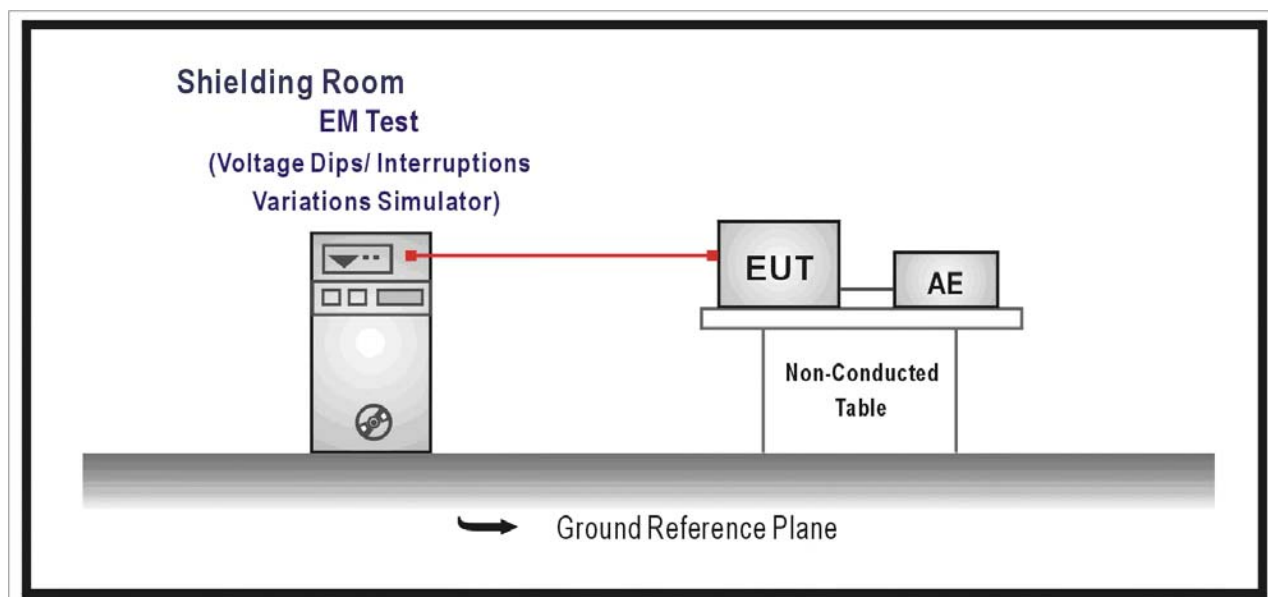

14.3. Limit

Item	Environmental Phenomena	Units	Test Specification	Performance Criteria
Input AC Power Ports				
	Voltage Dips	% Reduction	30	C
		Period	25	
	Voltage Dips	% Reduction	>95	B
		Period	0.5	
	Voltage Interruptions	% Reduction	> 95	C
		Period	250	

14.4. Test Procedure

The EUT and its load are placed on a table which is 0.8 meter above a metal ground plane measured 1m*1m min. And 0.65mm thick min. And projected beyond the EUT by at least 0.1m on all sides. The power cord shall be used the shortest power cord as specified by the manufacturer.

For Voltage Dips/ Interruptions test:

The selection of test voltage is based on the rated power range. If the operation range is large than 20% of lower power range, both end of specified voltage shall be tested.

Otherwise, the typical voltage specification is selected as test voltage.

The EUT is connected to the power mains through a coupling device that directly couples to the Voltage Dips and Interruption Generator.

The EUT shall be tested for 30% voltage dip of supplied voltage and duration 25 Periods, for 95% voltage dip of supplied voltage and duration 0.5 Periods with a sequence of three voltage dips with intervals of 10 seconds, and for 95% voltage interruption of supplied voltage and duration 250 Periods with a sequence of three voltage interruptions with intervals of 10 seconds.

Voltage phase shifting are shall occur at 0° , 45° , 90° , 135° , 180° , 225° , 270° , 315° of the voltage.

14.5. Deviation from Test Standard

No deviation.

14.6. Test Result

Product	Network Camera		
Test Item	Voltage dips and interruption		
Test Mode	Mode 1: Normal Operation		
Date of Test	2011/03/16	Test Site	No.3 Shielded Room

Voltage Dips and Interruption Reduction(%)	Angle	Test Duration (Periods)	Required Performance Criteria	Performance Criteria Complied To	Test Result
30	0	25	C	A	PASS
30	45	25	C	A	PASS
30	90	25	C	A	PASS
30	135	25	C	A	PASS
30	180	25	C	A	PASS
30	225	25	C	A	PASS
30	270	25	C	A	PASS
30	315	25	C	A	PASS
>95	0	0.5	B	A	PASS
>95	45	0.5	B	A	PASS
>95	90	0.5	B	A	PASS
>95	135	0.5	B	A	PASS
>95	180	0.5	B	A	PASS
>95	225	0.5	B	A	PASS
>95	270	0.5	B	A	PASS
>95	315	0.5	B	A	PASS
>95	0	250	C	C	PASS
>95	45	250	C	C	PASS
>95	90	250	C	C	PASS
>95	135	250	C	C	PASS
>95	180	250	C	C	PASS
>95	225	250	C	C	PASS
>95	270	250	C	C	PASS
>95	315	250	C	C	PASS

- Meet criteria A: Operate as intended during and after the test
- Meet criteria B: Operate as intended after the test
- Meet criteria C: Loss/Error of function
- Additional Information
 - The nominal voltage of EUT is 230V.
 - EUT stopped operation and could / could not be reset by operator at _____ kV of Line _____.
- No false alarms or other malfunctions were observed during or after the test. The acceptance criteria were met, and the EUT passed the test.

14.7. Test Photograph

Test Mode : Mode 1: Normal Operation

Description : Voltage Dips Test Setup



15. Attachment

➤ EUT Photograph

(1) EUT Photo



(2) EUT Photo



(3) EUT Photo



(4) EUT Photo



(5) EUT Photo



(6) EUT Photo

