



EMC Test report

Product Type : Network Camera
Applicant : VIVOTEK INC.
Address : 6F, No.192, Lien-Cheng Rd., Chung-Ho , New Taipei City, 235,
Taiwan, R.O.C.
Trade Name : VIVOTEK
Model Number : FE8171V
Test Specification : EN 55022: 2006+A1: 2007 / Class B
EN 55024: 1998+A1: 2001+A2: 2003
: EN 61000-3-2: 2006 + A2: 2009 / Class A
EN 61000-3-3: 2008
AS/NZS CISPR 22: 2009
Issue Date : Aug. 02, 2011

Issue by

A Test Lab Techno Corp.
No. 140-1, Changan Street, Bade City,
Taoyuan County 334, Taiwan R.O.C.
Tel : +886-3-2710188 / Fax : +886-3-2710190



Taiwan Accreditation Foundation accreditation number: 1330

Note: This report shall not be reproduced except in full, without the written approval of A Test Lab Techno Corp. This document may be altered or revised by A Test Lab Techno Corp. personnel only, and shall be noted in the revision section of the document. The client should not use it to claim product endorsement by TAF, or any government agencies. The test results in the report only apply to the tested sample.

Revision History

| Rev. | Issue Date | Revisions | Revised By |
|-------------|-------------------|------------------|-------------------|
| 00 | Aug. 02, 2011 | Initial Issue | |
| | | | |
| | | | |
| | | | |

Verification of Compliance

Issued Date: 2011/08/02

Product Type : Network Camera
Applicant : VIVOTEK INC.
Address : 6F, No.192, Lien-Cheng Rd., Chung-Ho , New Taipei City,
235, Taiwan, R.O.C.
Trade Name : VIVOTEK
Model Number : FE8171V
EUT Rated Voltage : DC 12 - 48V
Test Voltage : 230 Vac / 50 Hz, 48Vdc
Applicable : EN 55022: 2006+A1: 2007 / Class B
Standard : EN 55024: 1998+A1: 2001+A2: 2003
EN 61000-3-2: 2006 + A2: 2009 / Class A
EN 61000-3-3: 2008
AS/NZS CISPR 22: 2009
Test Result : Complied

Performing Lab. : A Test Lab Techno Corp.
No. 140-1, Changan Street, Bade City,
Taoyuan County 334, Taiwan R.O.C.
Tel : +886-3-2710188 / Fax : +886-3-2710190



Taiwan Accreditation Foundation accreditation number:
1330

<http://www.atl-lab.com.tw/e-index.htm>

The above equipment has been tested by A Test Lab Techno Corp., and found compliance with the requirements set forth in the Electromagnetic Compatibility Directive 2004/108/EC and technical standards mentioned above. The results of testing in this report apply only to the product/system, which was tested. Other similar equipment will not necessarily produce the same results due to production tolerance and measurement uncertainties.

Approved By : Miller Lee
(Manager) (Miller Lee)

Reviewed By : Gary Wu
(Testing Engineer) (Gary Wu)

TABLE OF CONTENTS

| | | |
|----------|---|-----------|
| 1 | General Information | 5 |
| 2 | EUT Description | 8 |
| 3 | Test Methodology | 9 |
| 3.1. | Decision of Test Mode | 9 |
| 3.2. | EUT Exercise Software | 9 |
| 3.3. | Configuration of Test System Details | 10 |
| 3.4. | Test Site Environment | 12 |
| 4 | Emission Test..... | 13 |
| 4.1. | Conducted Emission Measurement | 13 |
| 4.2. | Radiated Interference Measurement..... | 24 |
| 4.3. | Harmonics Current Measurement | 39 |
| 4.4. | Voltage Fluctuation and Flicker | 44 |
| 5 | Immunity Test..... | 48 |
| 5.1. | Electrostatic Discharge (ESD)..... | 48 |
| 5.2. | Radiated Electromagnetic Field (RS) | 57 |
| 5.3. | Electrical Fast Transient/Burst (EFT) | 62 |
| 5.4. | Surge | 66 |
| 5.5. | Conducted Susceptibility (CS) | 70 |
| 5.6. | Power Frequency Magnetic Field (PMF)..... | 75 |
| 5.7. | Voltage Dips and Interruption | 79 |
| 6 | EUT Photograph..... | 83 |

1 General Information

1.1 Summary of Test Result

| Emission | | | |
|--|---------------------------------|--------|------------------------|
| Standard | Item | Result | Remark |
| EN 55022: 2006+A1: 2007 AS/NZS CISPR 22: 2009 | Conducted and Radiated Emission | PASS | Meet Class B limit |
| EN 61000-3-2: 2006 + A2: 2009 | Harmonic current emissions | PASS | Meet Class A limit |
| EN 61000-3-3: 2008 | Voltage fluctuations & flicker | PASS | Meets the requirements |

| Immunity | | | |
|----------------------|-----------------------------------|--------|--|
| Standard | Item | Result | Remark |
| IEC 61000-4-2: 2008 | ESD | PASS | Meets the requirements of Criterion B |
| IEC 61000-4-3: 2008 | RS | PASS | Meets the requirements of Criterion A |
| IEC 61000-4-4: 2004 | EFT | PASS | Meets the requirements of Criterion B |
| IEC 61000-4-5: 2005 | Surge | PASS | Meets the requirements of Criterion B |
| IEC 61000-4-6: 2008 | CS | PASS | Meets the requirements of Criterion A |
| IEC 61000-4-8: 2009 | PMF | PASS | Meets the requirements of Criterion A |
| IEC 61000-4-11: 2004 | Voltage dips & voltage variations | PASS | Meets the requirements of Voltage Dips: 1) >95% reduction Criterion B 2) 30% reduction Criterion C Voltage Interruptions: 1) >95% reduction Criterion C |

The test results of this report relate only to the tested sample(s) identified in this report. Manufacturer or whom it may concern should recognize the pass or fail of the test result.

1.2 Measurement Uncertainty

Conducted Emission

The measurement uncertainty is evaluated as ± 2.26 dB.

Conducted Emissions (Telecommunication Ports)

The measurement uncertainty is evaluated as ± 2.26 dB.

Radiated Emission

The measurement uncertainty is evaluated as ± 3.19 dB.

Harmonic Current Emission

The measurement uncertainty is evaluated as ± 1.2 %.

Voltage Fluctuations and Flicker

The measurement uncertainty is evaluated as ± 1.5 %.

Electrostatic Discharge

As what is concluded in the document from Note2 of clause 5.4.6.2 of ISO/IEC 17025: 2005[E], the requirements for measurement uncertainty in ESD testing are deemed to have been satisfied, and the testing is reported in accordance with the relevant ESD standards. The immunity test signal from the ESD system meet the required specifications in IEC 61000-4-2 through the calibration report with the calibrated uncertainty for the waveform of voltage and timing as being 1.52 % and 2.69%.

Radiated susceptibility

As what is concluded in the document from Note2 of clause 5.4.6.2 of ISO/IEC 17025: 2005[E], the requirements for measurement uncertainty in RS testing are deemed to have been satisfied, and the testing is reported in accordance with the relevant RS standards. The immunity test signal from the RS system meet the required specifications in IEC 61000-4-3 through the calibration for the uniform field strength and monitoring for the test level with the uncertainty evaluation report for the electrical filed strength as being 2.65 dB.

Electrical fast transient/burst

As what is concluded in the document from Note2 of clause 5.4.6.2 of ISO/IEC 17025: 1999[2], the requirements for measurement uncertainty in EFT/Burst testing are deemed to have been satisfied, and the testing is reported in accordance with the relevant FT/Burst standards. The immunity test signal from the FT/Burst system meet the required specifications in IEC 61000-4-4 through the calibration report with the calibrated uncertainty for the waveform of voltage. Frequency and timing as being 1.57% and 2.73%.

Surge

As what is concluded in the document from Note2 of clause 5.4.6.2 of ISO/IEC 17025: 2005[E], the requirements for measurement uncertainty in Surge testing are deemed to have been satisfied, and the testing is reported in accordance with the relevant Surge standards. The immunity test signal from the Surge system meet the required specifications in IEC 61000-4-5 through the calibration report with the calibrated uncertainty for the waveform of voltage and timing as being 1.58 % and 2.71%.

Conducted susceptibility

As what is concluded in the document from Note2 of clause 5.4.6.2 of ISO/IEC 17025: 2005[E], the requirements for measurement uncertainty in CS testing are deemed to have been satisfied, and the testing is reported in accordance with the relevant CS standards. The immunity test signal from the CS system meet the required specifications in IEC 61000-4-6 through the calibration for unmodulated signal and monitoring for the test level with the uncertainty evaluation report for the injected modulated signal level through CDN and EM Clamp/Direct Injection as being 3.68 dB and 2.72 dB.

Power frequency magnetic field

As what is concluded in the document from Note2 of clause 5.4.6.2 of ISO/IEC 17025: 2005[E], the requirements for measurement uncertainty in PFM testing are deemed to have been satisfied, and the testing is reported in accordance with the relevant PFM standards. The immunity test signal from the PFM system meet the required specifications in IEC 61000-4-8 through the calibration report with the calibrated uncertainty for the Gauss Meter to verify the output level of magnetic field strength as being 1.8 %.

Voltage dips and interruption

As what is concluded in the document from Note2 of clause 5.4.6.2 of ISO/IEC 17025: 2005[E], the requirements for measurement uncertainty in DIP testing are deemed to have been satisfied, and the testing is reported in accordance with the relevant DIP standards. The immunity test signal from the DIP system meet the required specifications in IEC 61000-4-11 through the calibration report with the calibrated uncertainty for the waveform of voltage and timing as being 1.58 % and 2.72%.

2 EUT Description

| | | |
|----------------------|---|--|
| Product | : | Network Camera |
| Trade Name | : | VIVOTEK |
| Model Number | : | FE8171V |
| Applicant | : | VIVOTEK INC. 6F, No.192, Lien-Cheng Rd., Chung-Ho , New Taipei City, 235, Taiwan, R.O.C. |
| Manufacturer | : | VIVOTEK INC. 5F, No.168, Lien-Cheng Rd., Chung-Ho , New Taipei City, 235, Taiwan, R.O.C. |
| Component | | |
| Power Adapter | : | ENG, 3A-183WP12 I/P: 100-240VAC, 50-60Hz, 0.6A O/P: 12VDC, 1.5A Shielded, 1.7m, Non-Detachable at Power Adaptor |

I/O Port Description :

| I/O PORT TYPES | Q'TY | Test Description |
|--------------------|------|------------------------------|
| 1). LAN Port | 1 | Connected to Notebook or PoE |
| 2). Audio in Port | 1 | Connected to Microphone |
| 3). Audio out Port | 1 | Connected to Earphone |
| 4). Power Port | 1 | Connected to AC Adapter |

3 Test Methodology

3.1. Decision of Test Mode

3.1.1 The following test mode(s) were scanned during the preliminary test:

| Pre-Test Mode |
|--|
| Mode 1: Normal Operation with Adapter Mode |
| Mode 2: Normal Operation with PoE Mode |

3.1.2 After the preliminary scan, the following test mode was found to produce the highest emission level.

| Final Test Mode | | |
|-----------------|-----------------------------------|-----------------|
| Emission | Conducted Emission | Mode 1 / Mode 2 |
| | Radiated Emission | Mode 1 / Mode 2 |
| | Harmonic current emissions | Mode 1 |
| | Voltage fluctuations & flicker | Mode 1 |
| Immunity | ESD | Mode 1 / Mode 2 |
| | RS | Mode 1 / Mode 2 |
| | EFT | Mode 1 / Mode 2 |
| | Surge | Mode 1 |
| | CS | Mode 1 / Mode 2 |
| | PMF | Mode 1 / Mode 2 |
| | Voltage dips & voltage variations | Mode 1 |

Then, the above highest emission mode of the configuration of the EUT and cable was chosen for all final test items.

3.2. EUT Exercise Software

| |
|---|
| 1. Setup the EUT and simulators as shown on 3.3. |
| 2. Turn on the power of all equipment. |
| 3. The EUT will start to operate and display the video figure from the signal source. |
| 4. The EUT will display "video figure" on monitor. |
| 5. Repeat the above procedure (3) to (4). |

3.3. Configuration of Test System Details

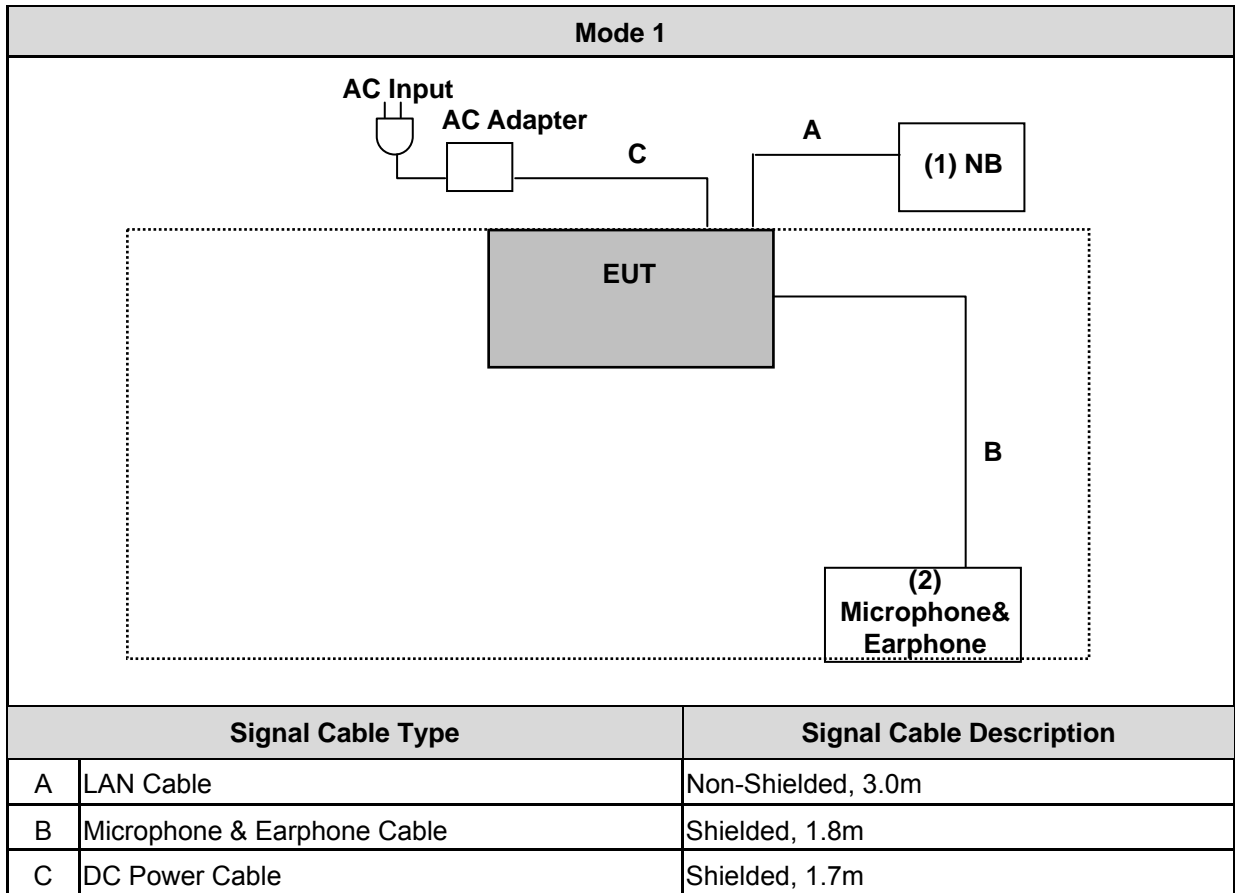

| Devices Description | | | | | |
|---------------------|-----------------------|--------------|--------------|------------------------------|--------------------|
| | Product | Manufacturer | Model Number | Serial Number | Power Cord |
| (1) | Notebook | DELL | D531 | CN-OXM006-48643-87 A-3398 | Non-Shielded, 2.0m |
| (2) | Microphone & Earphone | N/A | N/A | N/A | N/A |

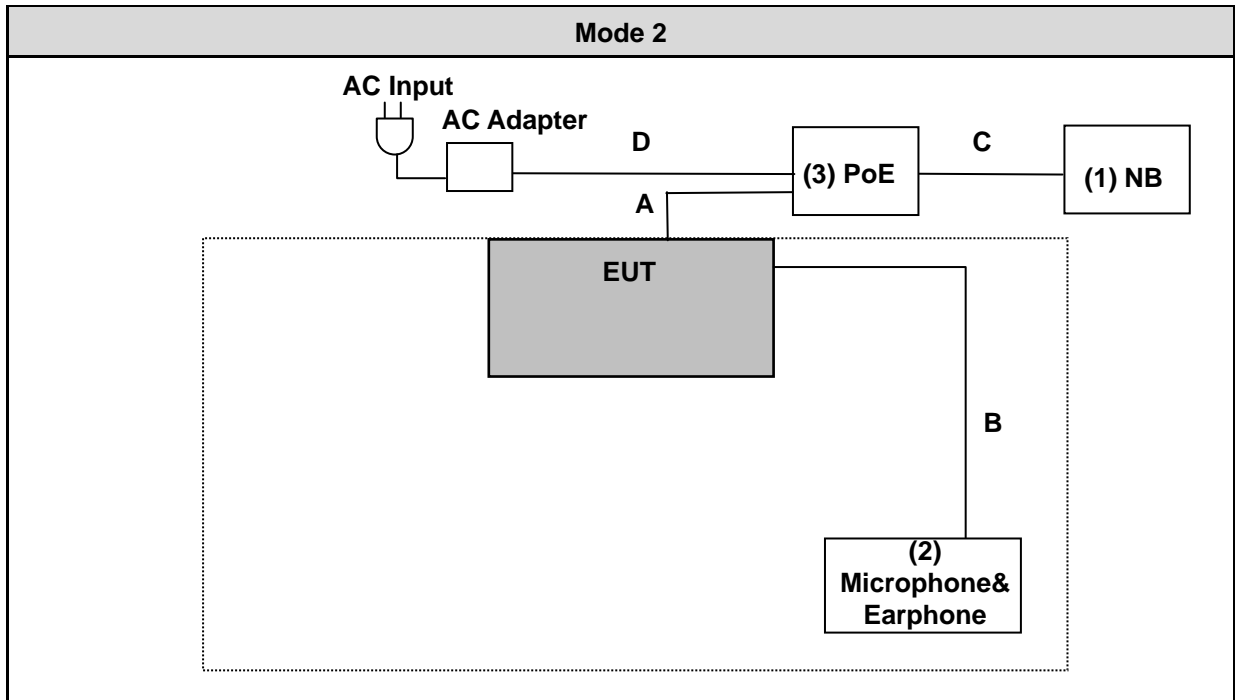

| Signal Cable Type | | Signal Cable Description |
|-------------------|-----------------------------|------------------------------|
| A | LAN Cable | Non-Shielded, 1.8m |
| B | Microphone & Earphone Cable | Shielded, 1.8m |
| C | LAN Cable | Non-Shielded, 3.0m |
| D | DC Power Cable | Shielded, 1.8m with one core |

| Devices Description | | | | | |
|---------------------|--------------------------------------|--------------|--------------|------------------------------|------------------------------|
| | Product | Manufacturer | Model Number | Serial Number | Power Cord |
| (1) | Notebook | DELL | D531 | CN-OXM006-48643-87 A-3398 | Non-Shielded, 2.0m |
| (2) | Microphone & Earphone | N/A | N/A | N/A | N/A |
| (3) | Power over Ethernet Adapter Injector | LINKSYS | WAPPOE | N/A | Shielded, 1.8m with one core |

3.4. Test Site Environment

| Items | Test Item | Required (IEC 68-1) | Actual |
|----------------------------|----------------|---------------------|--------|
| Temperature (°C) | EN 55022 CE | 15-35 | 26.0 |
| Humidity (%RH) | | 25-60 | 60.0 |
| Barometric pressure (mbar) | | 860-1060 | 950 |
| Temperature (°C) | EN 55022 RE | 15-35 | 26.0 |
| Humidity (%RH) | | 25-60 | 60.0 |
| Barometric pressure (mbar) | | 860-1060 | 950 |
| Temperature (°C) | EN 61000-3-2 | -- | 26.0 |
| Humidity (%RH) | | -- | 51.0 |
| Barometric pressure (mbar) | | -- | 950 |
| Temperature (°C) | EN 61000-3-3 | -- | 24.0 |
| Humidity (%RH) | | -- | 50.0 |
| Barometric pressure (mbar) | | -- | 950 |
| Temperature (°C) | IEC 61000-4-2 | 15-35 | 23.1 |
| Humidity (%RH) | | 30-60 | 48.6 |
| Barometric pressure (mbar) | | 860-1060 | 950 |
| Temperature (°C) | IEC 61000-4-3 | -- | 23.1 |
| Humidity (%RH) | | -- | 56.4 |
| Barometric pressure (mbar) | | -- | 950 |
| Temperature (°C) | IEC 61000-4-4 | 15-35 | 24.1 |
| Humidity (%RH) | | 30-60 | 48.6 |
| Barometric pressure (mbar) | | 860-1060 | 950 |
| Temperature (°C) | IEC 61000-4-5 | 15-35 | 24.1 |
| Humidity (%RH) | | 10-75 | 48.6 |
| Barometric pressure (mbar) | | 860-1060 | 950 |
| Temperature (°C) | IEC 61000-4-6 | -- | 24.5 |
| Humidity (%RH) | | -- | 46.6 |
| Barometric pressure (mbar) | | -- | 950 |
| Temperature (°C) | IEC 61000-4-8 | 15-35 | 23.1 |
| Humidity (%RH) | | 25-75 | 56.4 |
| Barometric pressure (mbar) | | 860-1060 | 950 |
| Temperature (°C) | IEC 61000-4-11 | 15-35 | 24.1 |
| Humidity (%RH) | | 25-75 | 48.6 |
| Barometric pressure (mbar) | | 860-1060 | 950 |

4 Emission Test

4.1. Conducted Emission Measurement

4.1.1. Limit

4.1.1.1. A.C. Mains Conducted Interference Limit :

| Frequency (MHz) | Class A (dBuV) | | Class B (dBuV) | |
|-----------------|----------------|---------|----------------|---------|
| | Quasi-peak | Average | Quasi-peak | Average |
| 0.15 - 0.5 | 79 | 66 | 66 - 56 | 56 - 46 |
| 0.50 - 5.0 | 73 | 60 | 56 | 46 |
| 5.0 - 30.0 | 73 | 60 | 60 | 50 |

Note: (1) The lower limit shall apply at the transition frequencies.

(2) The limit decreases in line with the logarithm of the frequency in the range 0.15 to 0.50 MHz.

4.1.1.2. Telecommunication Port Conducted Interference Limits:

| Requirement (MHz) | Class A Equipment | | | | Class B Equipment | | | |
|-------------------|----------------------------|----------|----------------------------|----------|----------------------------|----------|----------------------------|----------|
| | Voltage Limit (dB μ V) | | Current Limit (dB μ A) | | Voltage Limit (dB μ V) | | Current Limit (dB μ A) | |
| | QP | Avg. | QP | Avg. | QP | Avg. | QP | Avg. |
| 0.15 to 0.50 | 97 to 87 | 84 to 74 | 53 to 43 | 40 to 30 | 84 to 74 | 74 to 64 | 40 to 30 | 30 to 20 |
| 0.50 to 30 | 87 | 74 | 43 | 30 | 74 | 64 | 30 | 20 |

4.1.2. Test Instruments

| Describe | Manufacturer | Model Number | Serial Number | Cal. Date | Remark |
|---------------|--------------|-----------------|---------------|------------|--------|
| Test Receiver | R&S | ESCI | 100367 | 06/30/2011 | (1) |
| LISN | R&S | ENV216 | 101040 | 03/04/2011 | (1) |
| LISN | R&S | ENV216 | 101041 | 03/04/2011 | (1) |
| T-LISN | FCC | FCC-TLISN-T2-02 | 20574 | 05/13/2011 | (1) |
| T-LISN | FCC | FCC-TLISN-T4-02 | 20529 | 04/19/2011 | (1) |
| T-LISN | FCC | FCC-TLISN-T8-02 | 20576 | 05/13/2011 | (1) |
| Test Site | ATL | TE02 | TE02 | N.C.R. | ----- |

Remark: (1) Calibration period 1 year. (2) Calibration period 2 years.

NOTE: N.C.R. = No Calibration Request.

4.1.3. Test Setup

A.C. Mains Setup

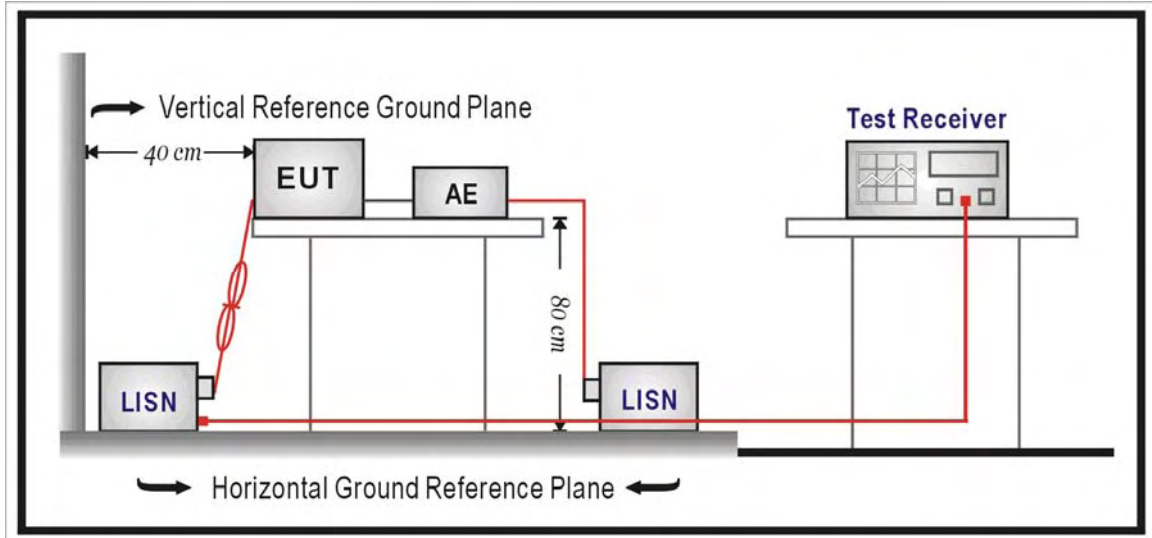

Telecommunication Port Setup

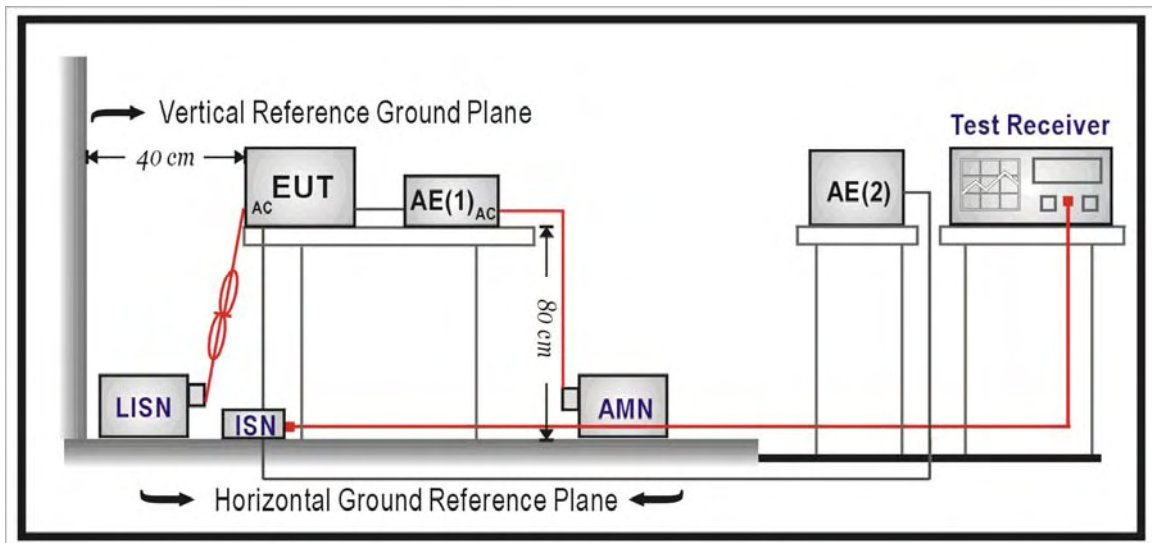

4.1.4. Test Procedure

The EUT and simulators are connected to the main power through a line impedance stabilization network (L.I.S.N.). This provides a 50 ohm /50uH coupling impedance for the measuring equipment. The peripheral devices are also connected to the main power through a LISN that provides a 50ohm/50uH coupling impedance with 50ohm termination.

The mains voltage shall be supplied to the EUT via the LISN when the measurement of telecommunication port is performed. The common mode disturbances at the telecommunication port shall be connected to the ISN.

For A.C. mains conducted interference, measured both sides of A.C. lines and carried out using quasi-peak and average detector receivers of maximum conducted interference.

For telecommunication port interference measurement, using ISNs with suitable longitudinal conversion losses (LCL) as defined in the port of specification from manufacture, and the LCL shall be meet the related standard requirement. Measured the line and carried out using quasi-peak and average detector receivers of maximum conducted interference.

Conducted emissions were invested over the frequency range from 0.15 MHz to 30 MHz using a receiver bandwidth of 9 kHz. The equipment under test (EUT) shall be meet the limits in section 4.1.2, as applicable, including the average limit and the quasi-peak limit when using respectively (A.C. mains and telecommunication port), an average detector and quasi-peak detector measured in accordance with the methods described of related standard. Either the voltage limits or the current limits shall be met. If the average limit is met when using a quasi-peak detector receiver, the EUT shall be deemed to meet both limits and measurement with the average detector receiver is unnecessary.

If the reading of the measuring receiver shows fluctuations close to the limit, the reading shall be observed for at least 15 s at each measurement frequency; the higher reading shall be recorded with the exception of any brief isolated high reading which shall be ignored.

4.1.5. Test Result

| | | | |
|---------------------|---------------------------|-----------------------------|---------------------|
| Standard: | EN 55022 Class B | Line: | L1 |
| Test item: | Conducted Emission | Power: | AC 230V/50Hz |
| Model: | FE8171V | Temp.(°C)/Hum.(%RH): | 26(°C)/60%RH |
| Mode: | Mode 1 | Date: | 2011/07/22 |
| | | Test By: | Gary Wu |
| Description: | | | |

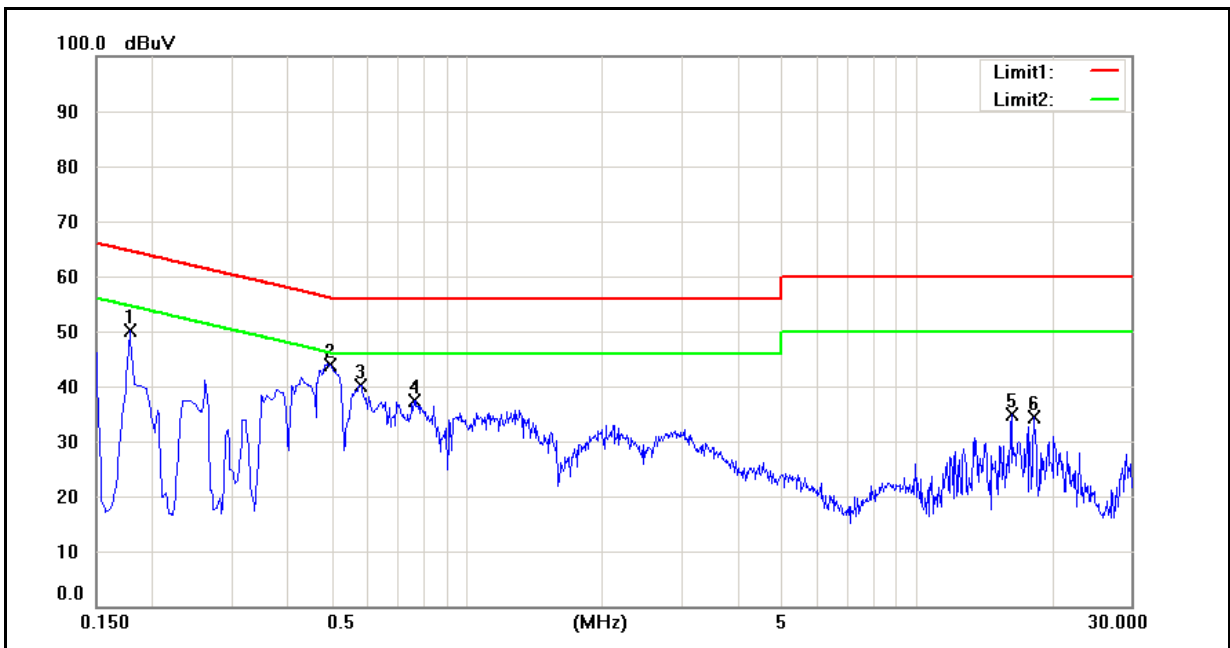

| No. | Frequency (MHz) | QP reading (dBuV) | AVG reading (dBuV) | Correction factor (dB) | QP result (dBuV) | AVG result (dBuV) | QP limit (dBuV) | AVG limit (dBuV) | QP margin (dB) | AVG margin (dB) | Remark |
|-----|-----------------|-------------------|--------------------|------------------------|------------------|-------------------|-----------------|------------------|----------------|-----------------|--------|
| 1 | 0.1780 | 33.41 | 22.57 | 10.06 | 43.47 | 32.63 | 64.58 | 54.58 | -21.11 | -21.95 | Pass |
| 2 | 0.4994 | 32.97 | 20.03 | 9.93 | 42.90 | 29.96 | 56.01 | 46.01 | -13.11 | -16.05 | Pass |
| 3 | 0.5820 | 27.97 | 15.18 | 9.90 | 37.87 | 25.08 | 56.00 | 46.00 | -18.13 | -20.92 | Pass |
| 4 | 0.7660 | 25.54 | 15.46 | 9.83 | 35.37 | 25.29 | 56.00 | 46.00 | -20.63 | -20.71 | Pass |
| 5 | 16.2300 | 21.37 | 18.26 | 10.19 | 31.56 | 28.45 | 60.00 | 50.00 | -28.44 | -21.55 | Pass |
| 6 | 18.2420 | 22.34 | 19.70 | 10.35 | 32.69 | 30.05 | 60.00 | 50.00 | -27.31 | -19.95 | Pass |

| | | | |
|-------------------|--------------------|-----------------------------|--------------|
| Standard: | EN 55022 Class B | Line: | N |
| Test item: | Conducted Emission | Power: | AC 230V/50Hz |
| Model: | FE8171V | Temp.(°C)/Hum.(%RH): | 26(°C)/60%RH |
| Mode: | Mode 1 | Date: | 2011/07/22 |
| | | Test By: | Gary Wu |

Description:

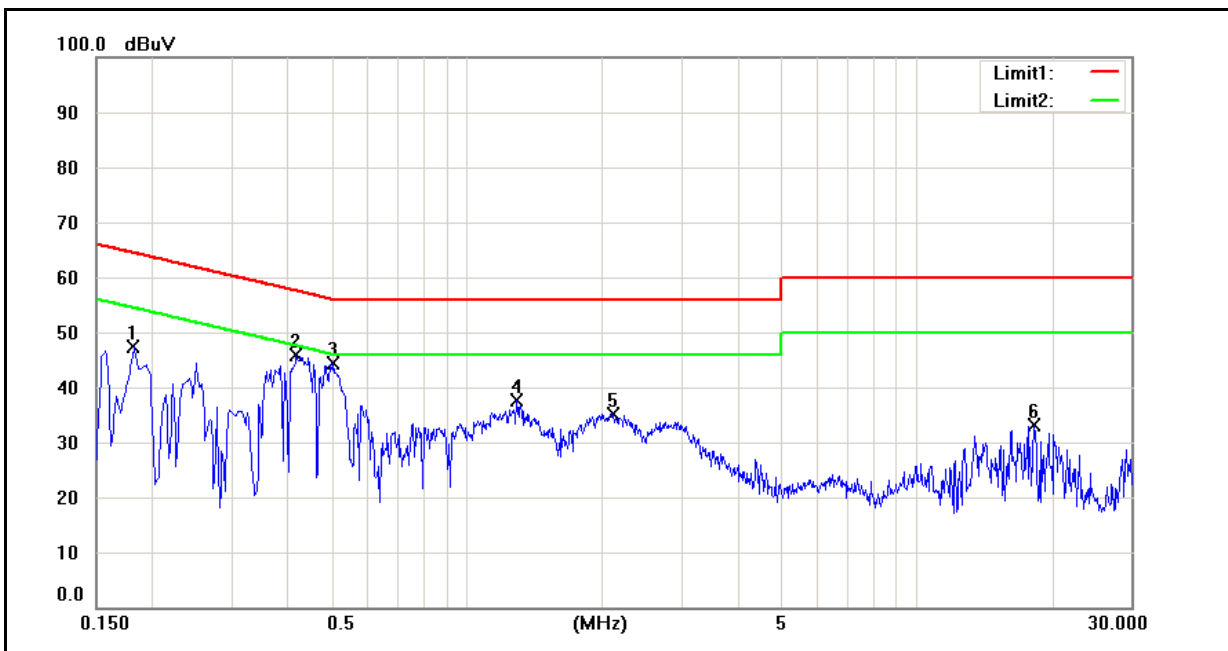

| No. | Frequency (MHz) | QP reading (dBuV) | AVG reading (dBuV) | Correction factor (dB) | QP result (dBuV) | AVG result (dBuV) | QP limit (dBuV) | AVG limit (dBuV) | QP margin (dB) | AVG margin (dB) | Remark |
|-----|-----------------|-------------------|--------------------|------------------------|------------------|-------------------|-----------------|------------------|----------------|-----------------|--------|
| 1 | 0.1820 | 34.95 | 27.21 | 10.06 | 45.01 | 37.27 | 64.39 | 54.39 | -19.38 | -17.12 | Pass |
| 2 | 0.4180 | 34.01 | 23.04 | 9.96 | 43.97 | 33.00 | 57.49 | 47.49 | -13.52 | -14.49 | Pass |
| 3 | 0.5060 | 33.17 | 19.66 | 9.93 | 43.10 | 29.59 | 56.00 | 46.00 | -12.90 | -16.41 | Pass |
| 4 | 1.2940 | 24.23 | 16.10 | 9.70 | 33.93 | 25.80 | 56.00 | 46.00 | -22.07 | -20.20 | Pass |
| 5 | 2.1140 | 23.63 | 16.19 | 9.69 | 33.32 | 25.88 | 56.00 | 46.00 | -22.68 | -20.12 | Pass |
| 6 | 18.2420 | 22.44 | 19.76 | 10.35 | 32.79 | 30.11 | 60.00 | 50.00 | -27.21 | -19.89 | Pass |

| | | | |
|-------------------|----------------------|-----------------------------|--------------|
| Standard: | ISN(Voltage)-Class B | Line: | N/A |
| Test item: | Conducted Emission | Power: | AC 230V/50Hz |
| Model: | FE8171V | Temp.(°C)/Hum.(%RH): | 26(°C)/60%RH |
| Mode: | Mode 1 (ISN 10M) | Date: | 2011/07/22 |
| | | Test By: | Gary Wu |

Description:

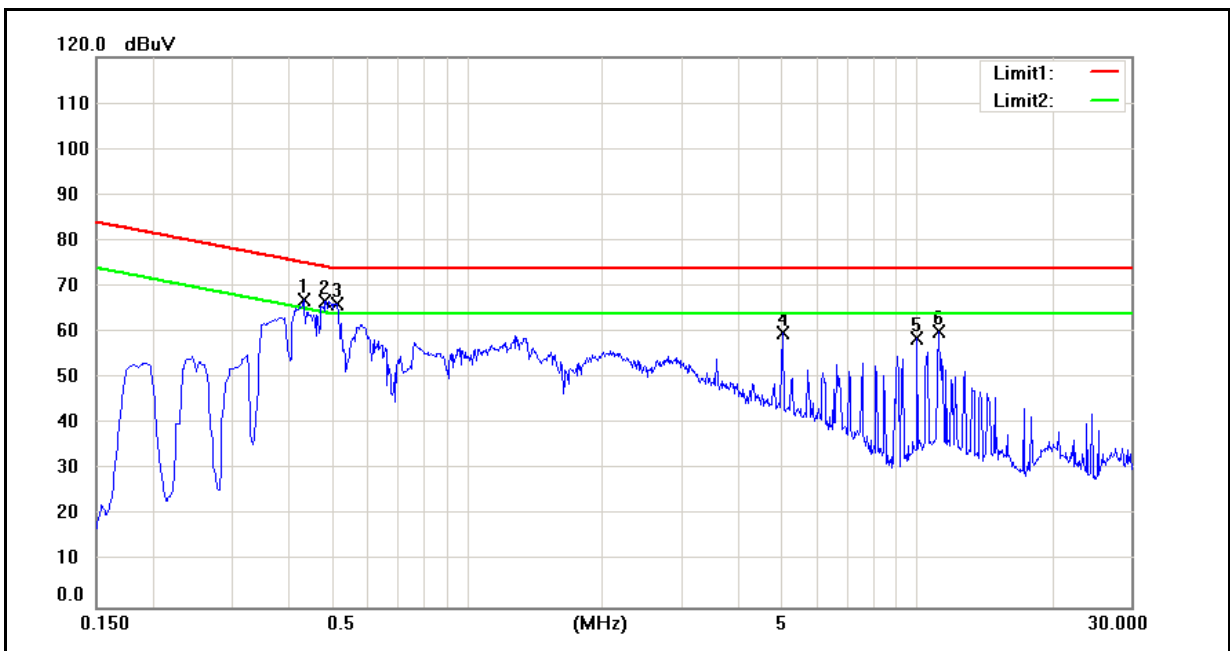

| No. | Frequency (MHz) | QP reading (dBuV) | AVG reading (dBuV) | Correction factor (dB) | QP result (dBuV) | AVG result (dBuV) | QP limit (dBuV) | AVG limit (dBuV) | QP margin (dB) | AVG margin (dB) | Remark |
|-----|-----------------|-------------------|--------------------|------------------------|------------------|-------------------|-----------------|------------------|----------------|-----------------|--------|
| 1 | 0.4340 | 53.79 | 42.01 | 10.32 | 64.11 | 52.33 | 75.18 | 65.18 | -11.07 | -12.85 | Pass |
| 2 | 0.4860 | 55.26 | 42.22 | 10.29 | 65.55 | 52.51 | 74.24 | 64.24 | -8.69 | -11.73 | Pass |
| 3 | 0.5181 | 52.91 | 38.24 | 10.27 | 63.18 | 48.51 | 74.00 | 64.00 | -10.82 | -15.49 | Pass |
| 4 | 5.0540 | 43.54 | 26.03 | 10.05 | 53.59 | 36.08 | 74.00 | 64.00 | -20.41 | -27.92 | Pass |
| 5 | 10.0700 | 22.29 | 13.90 | 10.38 | 32.67 | 24.28 | 74.00 | 64.00 | -41.33 | -39.72 | Pass |
| 6 | 11.2460 | 46.10 | 25.87 | 10.46 | 56.56 | 36.33 | 74.00 | 64.00 | -17.44 | -27.67 | Pass |

| | | | |
|-------------------|----------------------|-----------------------------|--------------|
| Standard: | ISN(Voltage)-Class B | Line: | N/A |
| Test item: | Conducted Emission | Power: | AC 230V/50Hz |
| Model: | FE8171V | Temp.(°C)/Hum.(%RH): | 26(°C)/60%RH |
| Mode: | Mode 1 (ISN 100M) | Date: | 2011/07/22 |
| | | Test By: | Gary Wu |

Description:

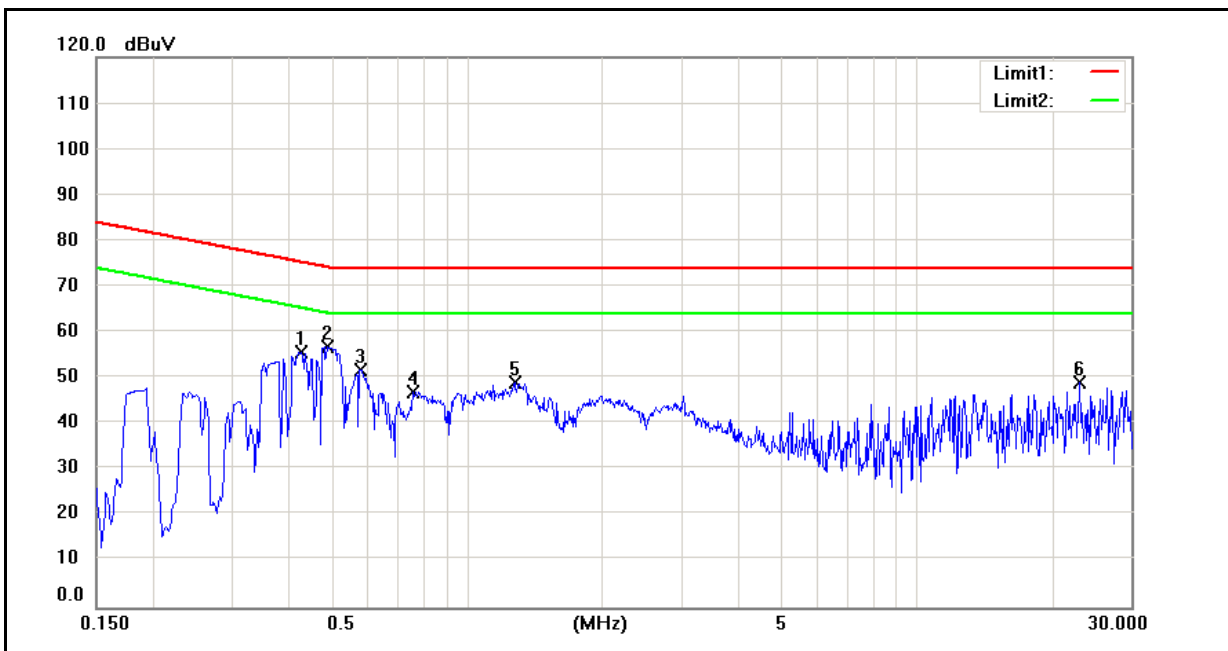

| No. | Frequency (MHz) | QP reading (dBuV) | AVG reading (dBuV) | Correction factor (dB) | QP result (dBuV) | AVG result (dBuV) | QP limit (dBuV) | AVG limit (dBuV) | QP margin (dB) | AVG margin (dB) | Remark |
|-----|-----------------|-------------------|--------------------|------------------------|------------------|-------------------|-----------------|------------------|----------------|-----------------|--------|
| 1 | 0.4300 | 44.15 | 32.22 | 10.32 | 54.47 | 42.54 | 75.25 | 65.25 | -20.78 | -22.71 | Pass |
| 2 | 0.4900 | 44.91 | 33.13 | 10.28 | 55.19 | 43.41 | 74.17 | 64.17 | -18.98 | -20.76 | Pass |
| 3 | 0.5820 | 39.64 | 26.74 | 10.24 | 49.88 | 36.98 | 74.00 | 64.00 | -24.12 | -27.02 | Pass |
| 4 | 0.7620 | 34.48 | 23.25 | 10.14 | 44.62 | 33.39 | 74.00 | 64.00 | -29.38 | -30.61 | Pass |
| 5 | 1.2820 | 37.16 | 26.54 | 9.99 | 47.15 | 36.53 | 74.00 | 64.00 | -26.85 | -27.47 | Pass |
| 6 | 23.1300 | 37.52 | 34.70 | 10.64 | 48.16 | 45.34 | 74.00 | 64.00 | -25.84 | -18.66 | Pass |

| | | | |
|-------------------|----------------------|-----------------------------|--------------|
| Standard: | ISN(Voltage)-Class B | Line: | N/A |
| Test item: | Conducted Emission | Power: | DC 48V |
| Model: | FE8171V | Temp.(°C)/Hum.(%RH): | 26(°C)/60%RH |
| Mode: | Mode 2 (ISN 10M) | Date: | 2011/07/22 |
| | | Test By: | Gary Wu |

Description:

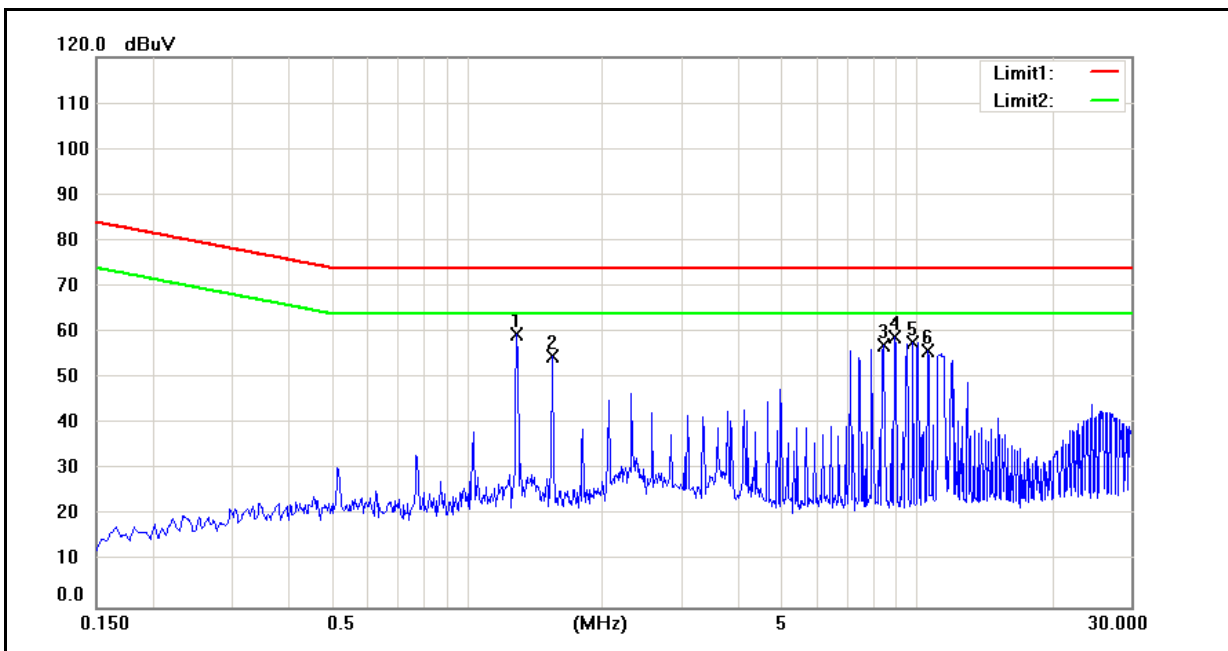

| No. | Frequency (MHz) | QP reading (dBuV) | AVG reading (dBuV) | Correction factor (dB) | QP result (dBuV) | AVG result (dBuV) | QP limit (dBuV) | AVG limit (dBuV) | QP margin (dB) | AVG margin (dB) | Remark |
|-----|-----------------|-------------------|--------------------|------------------------|------------------|-------------------|-----------------|------------------|----------------|-----------------|--------|
| 1 | 1.2940 | 40.76 | 40.75 | 18.32 | 59.08 | 59.07 | 74.00 | 64.00 | -14.92 | -4.93 | Pass |
| 2 | 1.5500 | 35.97 | 35.96 | 18.30 | 54.27 | 54.26 | 74.00 | 64.00 | -19.73 | -9.74 | Pass |
| 3 | 8.4460 | 21.55 | -3.74 | 18.63 | 40.18 | 14.89 | 74.00 | 64.00 | -33.82 | -49.11 | Pass |
| 4 | 8.9460 | -0.41 | -1.93 | 18.70 | 18.29 | 16.77 | 74.00 | 64.00 | -55.71 | -47.23 | Pass |
| 5 | 9.8100 | 3.06 | -2.48 | 18.81 | 21.87 | 16.33 | 74.00 | 64.00 | -52.13 | -47.67 | Pass |
| 6 | 10.6020 | 20.27 | 19.63 | 18.91 | 39.18 | 38.54 | 74.00 | 64.00 | -34.82 | -25.46 | Pass |

| | | | |
|-------------------|----------------------|-----------------------------|--------------|
| Standard: | ISN(Voltage)-Class B | Line: | N/A |
| Test item: | Conducted Emission | Power: | DC 48V |
| Model: | FE8171V | Temp.(°C)/Hum.(%RH): | 26(°C)/60%RH |
| Mode: | Mode 2 (ISN 100M) | Date: | 2011/07/22 |
| | | Test By: | Gary Wu |

Description:

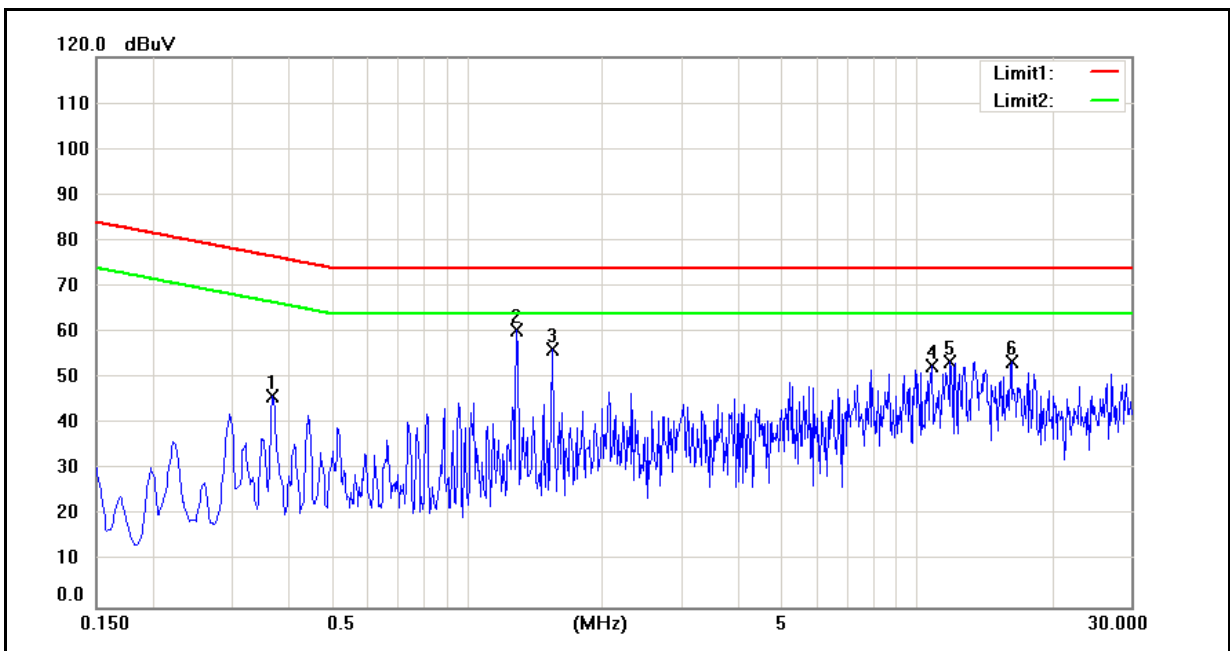

| No. | Frequency (MHz) | QP reading (dBuV) | AVG reading (dBuV) | Correction factor (dB) | QP result (dBuV) | AVG result (dBuV) | QP limit (dBuV) | AVG limit (dBuV) | QP margin (dB) | AVG margin (dB) | Remark |
|-----|-----------------|-------------------|--------------------|------------------------|------------------|-------------------|-----------------|------------------|----------------|-----------------|--------|
| 1 | 0.3700 | 26.82 | 26.80 | 18.53 | 45.35 | 45.33 | 76.50 | 66.50 | -31.15 | -21.17 | Pass |
| 2 | 1.2940 | 41.45 | 41.44 | 18.32 | 59.77 | 59.76 | 74.00 | 64.00 | -14.23 | -4.24 | Pass |
| 3 | 1.5540 | 36.69 | 36.33 | 18.30 | 54.99 | 54.63 | 74.00 | 64.00 | -19.01 | -9.37 | Pass |
| 4 | 10.7940 | 32.96 | 30.07 | 18.92 | 51.88 | 48.99 | 74.00 | 64.00 | -22.12 | -15.01 | Pass |
| 5 | 11.8940 | 33.13 | 30.04 | 18.99 | 52.12 | 49.03 | 74.00 | 64.00 | -21.88 | -14.97 | Pass |
| 6 | 16.2300 | 33.62 | 29.83 | 18.93 | 52.55 | 48.76 | 74.00 | 64.00 | -21.45 | -15.24 | Pass |

4.1.6. Test Photograph

A.C. Mains:

Test Mode : Mode 1

Description : Front View of Conducted Test



Test Mode : Mode 1

Description : Back View of Conducted Test

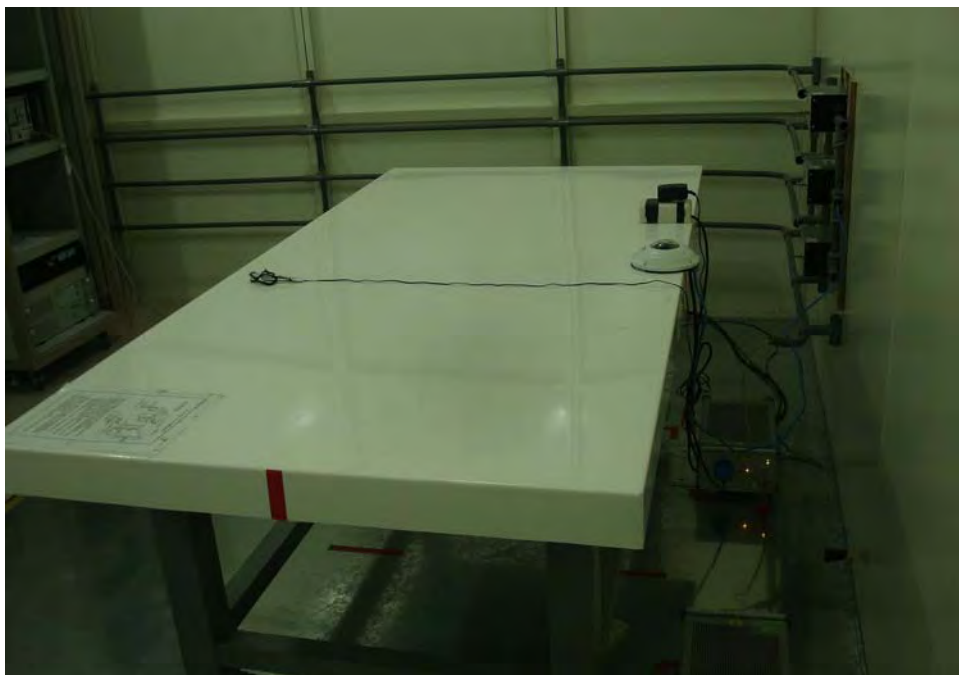

A.C. Mains:

Test Mode : Mode 2

Description : Front View of Conducted Test



Test Mode : Mode 2

Description : Back View of Conducted Test



4.2. Radiated Interference Measurement

4.2.1. Limit

| Frequency (MHz) | dBuV/m (Distance 10m) | |
|-----------------|-----------------------|---------|
| | Class A | Class B |
| 30 ~ 230 | 40 | 30 |
| 230 ~ 1000 | 47 | 37 |

NOTE: The lower limit shall apply at the transition frequencies.

| Frequency (MHz) | dBuV/m (Distance 3m) | | | |
|-----------------|----------------------|------|---------|------|
| | Class A | | Class B | |
| | Average | Peak | Average | Peak |
| 1000 ~ 3000 | 56 | 76 | 50 | 70 |
| 3000 ~ 6000 | 60 | 80 | 54 | 74 |

NOTE: The lower limit shall apply at the transition frequencies.

4.2.2. Test Instruments

| 10 Meter Chamber | | | | | |
|----------------------------|--------------------------------|--------------|---------------|------------|--------|
| Equipment | Manufacturer | Model Number | Serial Number | Cal. Date | Remark |
| Pre Amplifier | Agilent | 8447D | 2944A11120 | 01/11/2011 | (1) |
| Pre Amplifier | Agilent | 8447D | 2944A11119 | 01/11/2011 | (1) |
| Test Receiver | R&S | ESCI | 100722 | 10/14/2010 | (1) |
| Test Receiver | R&S | ESCI | 101000 | 12/15/2010 | (1) |
| Broadband Antenna | SCHWARZBECK MESS-ELEKTRONIK | VULB 9160 | 9160-3268 | 07/01/2011 | (1) |
| Broadband Antenna | SCHWARZBECK MESS-ELEKTRONIK | VULB 9160 | 9160-3273 | 12/30/2010 | (1) |
| Horn Antenna (1~18GHz) | SCHWARZBECK MESS-ELEKTRONIK | BBHA9120D | 9120D-550 | 06/29/2011 | (1) |
| Horn Antenna (18~40GHz) | SCHWARZBECK MESS-ELEKTRONIK | BBHA9170 | 9170-320 | 06/28/2011 | (1) |
| Test Site | ATL | TE06 | TE06 | N.C.R. | ---- |

Remark: ⁽¹⁾ Calibration period 1 year. ⁽²⁾ Calibration period 2 years.

NOTE: N.C.R. = No Calibration Request.

| 3 Meter Chamber | | | | | |
|--------------------------------|------------------------------|--------------|---------------|------------|--------|
| Equipment | Manufacturer | Model Number | Serial Number | Cal. Date | Remark |
| RF Pre-selector | Agilent | N9039A | MY46520256 | 01/18/2011 | (2) |
| Spectrum Analyzer | Agilent | E4446A | MY46180578 | 01/18/2011 | (1) |
| Pre Amplifier | Agilent | 8449B | 3008A02237 | 02/23/2011 | (1) |
| Pre Amplifier | Agilent | 8447D | 2944A10961 | 02/23/2011 | (1) |
| Broadband Antenna (30MHz~1GHz) | SCHWARZBECK MESS-ELEKTRO NIK | VULB9163 | 9163-270 | 08/02/2010 | (1) |
| Horn Antenna (1~18GHz) | SCHWARZBECK MESS-ELEKTRO NIK | BBHA9120D | 9120D-550 | 06/29/2011 | (1) |
| Horn Antenna (18~40GHz) | SCHWARZBECK MESS-ELEKTRO NIK | BBHA9170 | 9170-320 | 06/28/2011 | (1) |
| Test Site | ATL | TE01 | 888001 | 07/30/2010 | (1) |

Remark: ⁽¹⁾ Calibration period 1 year. ⁽²⁾ Calibration period 2 years.

NOTE: N.C.R. = No Calibration Request.

4.2.3. Setup

Below 1GHz

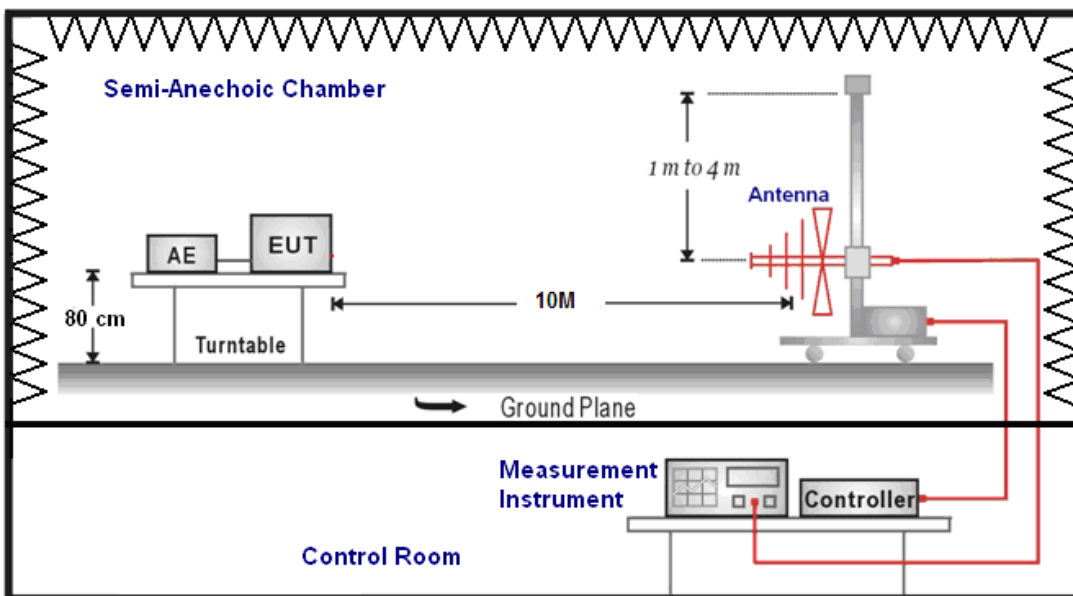

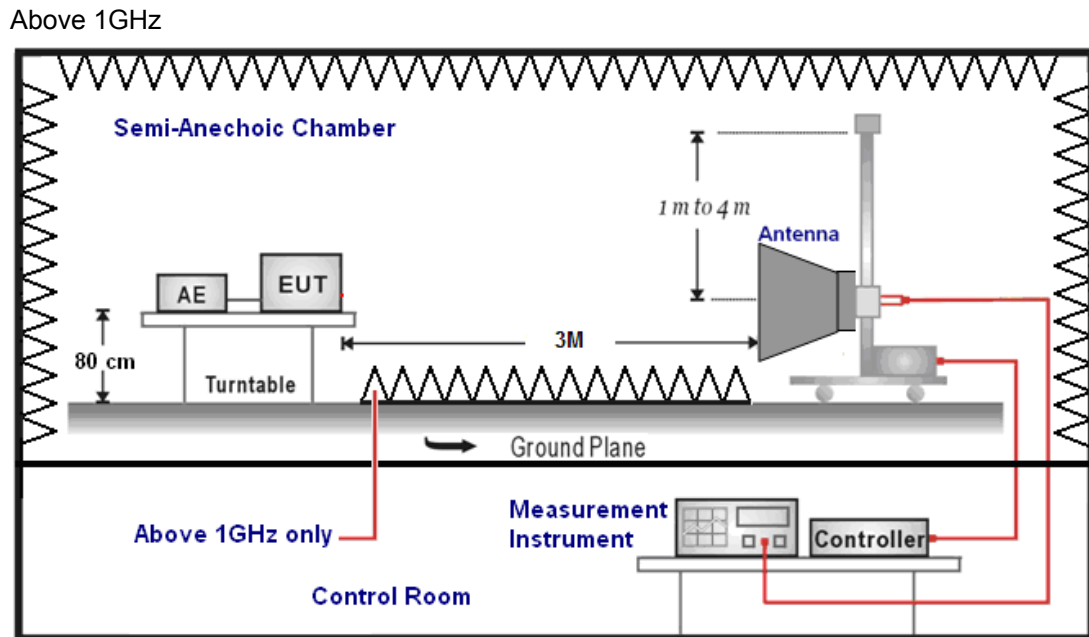

4.2.4. Test Procedure

The EUT and its simulators are placed on a turn table which is 0.8 meter above ground. When the EUT is floor-standing equipment, it is placed on the ground plane which has a 15 cm non-conductive covering to insulate the EUT from the ground plane.

The turn table can rotate 360 degrees to determine the position of the maximum emission level. The EUT was positioned such that the distance from antenna to the EUT was 10 meters for under 1GHz, and 3 meter for above 1GHz if the highest internal source frequency of the EUT is higher than 108 MHz.

The highest internal source of a EUT is defined as the highest frequency generated or used within the EUT or on which the EUT operates or tunes. If the highest frequency of the internal sources of the EUT is less than 108 MHz, the measurement shall only be made up to 1 GHz. If the highest frequency of the internal sources of the EUT is between 108 MHz and 500 MHz, the measurement shall only be made up to 2 GHz. If the highest frequency of the internal sources of the EUT is between 500 MHz and 1 GHz, the measurement shall only be made up to 5 GHz. If the highest frequency of the internal sources of the EUT is above 1 GHz, the measurement shall be made up to 5 times the highest frequency or 6 GHz, whichever is less.

The antenna can move up and down between 1 meter and 4 meters to find out the maximum emission level. Both horizontal and vertical polarization of the antenna are set on measurement. In order to find the maximum emission, all of the interface cables must be manipulated on radiated measurement.

Radiated emissions were investigated over the frequency range from 30MHz to 1GHz using a receiver bandwidth of 120 kHz. Radiated was performed at an antenna to EUT distance of 10 meters.

4.2.5. Test Result

| | | | |
|--------------------|--------------------------|-----------------------------|---------------------|
| Standard: | EN 55022 Class B | Test Distance: | 10m |
| Test item: | Radiated Emission | Power: | AC 230V/50Hz |
| Model: | FE8171V | Temp.(°C)/Hum.(%RH): | 26(°C)/60%RH |
| Mode: | Mode 1 | Date: | 2011/07/20 |
| Ant.Polar.: | Horizontal | Test By: | Gary Wu |

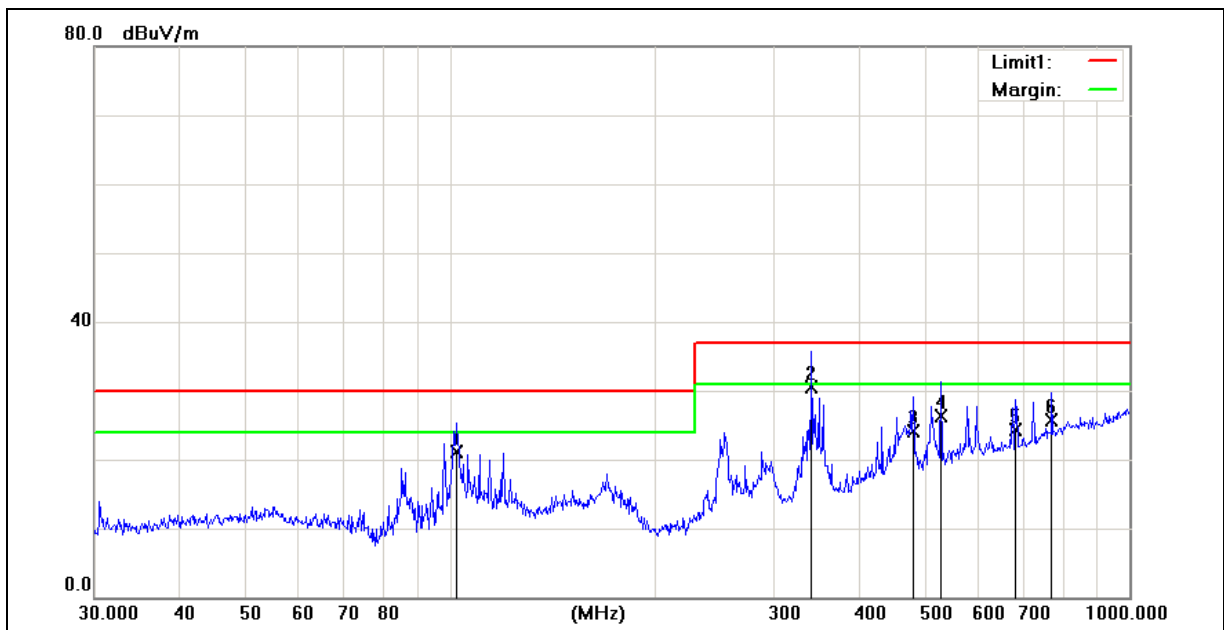

| No. | Frequency (MHz) | Reading (dBuV) | Correct Factor(dB/m) | Result (dBuV/m) | Limit (dBuV/m) | Margin (dB) | Height (cm) | Degree (°) | Remark |
|-----|-----------------|----------------|----------------------|-----------------|----------------|-------------|-------------|------------|--------|
| 1 | 102.3597 | 37.57 | -16.47 | 21.10 | 30.00 | -8.90 | 400 | 105 | QP |
| 2 | 340.7817 | 40.77 | -10.27 | 30.50 | 37.00 | -6.50 | 399 | 0 | QP |
| 3 | 480.5276 | 31.53 | -7.33 | 24.20 | 37.00 | -12.80 | 300 | 44 | QP |
| 4 | 528.2458 | 32.84 | -6.54 | 26.30 | 37.00 | -10.70 | 200 | 43 | QP |
| 5 | 679.9600 | 27.88 | -3.48 | 24.40 | 37.00 | -12.60 | 200 | 189 | QP |
| 6 | 768.7481 | 27.12 | -1.42 | 25.70 | 37.00 | -11.30 | 100 | 139 | QP |

| | | | |
|--------------------|-------------------|-----------------------------|--------------|
| Standard: | EN 55022 Class B | Test Distance: | 10m |
| Test item: | Radiated Emission | Power: | AC 230V/50Hz |
| Model: | FE8171V | Temp.(°C)/Hum.(%RH): | 26(°C)/60%RH |
| Mode: | Mode 1 | Date: | 2011/07/20 |
| Ant.Polar.: | Vertical | Test By: | Gary Wu |

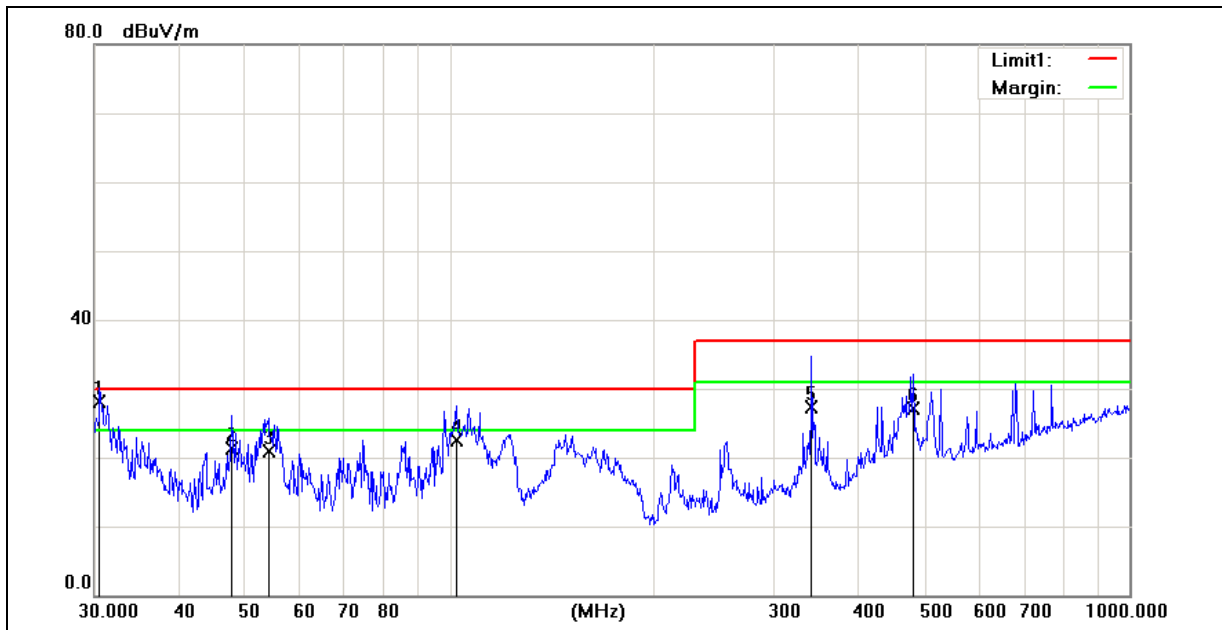

| No. | Frequency (MHz) | Reading (dBuV) | Correct Factor(dB/m) | Result (dBuV/m) | Limit (dBuV/m) | Margin (dB) | Height (cm) | Degree (°) | Remark |
|-----|-----------------|----------------|----------------------|-----------------|----------------|-------------|-------------|------------|--------|
| 1 | 30.5306 | 43.70 | -15.60 | 28.10 | 30.00 | -1.90 | 100 | 149 | QP |
| 2 | 47.8260 | 35.38 | -14.08 | 21.30 | 30.00 | -8.70 | 100 | 354 | QP |
| 3 | 54.0711 | 34.98 | -14.08 | 20.90 | 30.00 | -9.10 | 100 | 294 | QP |
| 4 | 102.3597 | 38.86 | -16.36 | 22.50 | 30.00 | -7.50 | 199 | 41 | QP |
| 5 | 340.7817 | 36.85 | -9.45 | 27.40 | 37.00 | -9.60 | 200 | 360 | QP |
| 6 | 480.5276 | 33.35 | -6.15 | 27.20 | 37.00 | -9.80 | 100 | 0 | QP |

| | | | |
|--------------------|--------------------|-----------------------------|--------------|
| Standard: | EN 55022 Class B | Test Distance: | 3m |
| Test item: | Radiated Emission | Power: | AC 230V/50Hz |
| Model: | FE8171V | Temp.(°C)/Hum.(%RH): | 26(°C)/60%RH |
| Mode: | Mode 1 (1GHz~6GHz) | Date: | 2011/07/26 |
| Ant.Polar.: | Horizontal | Test By: | Gary Wu |

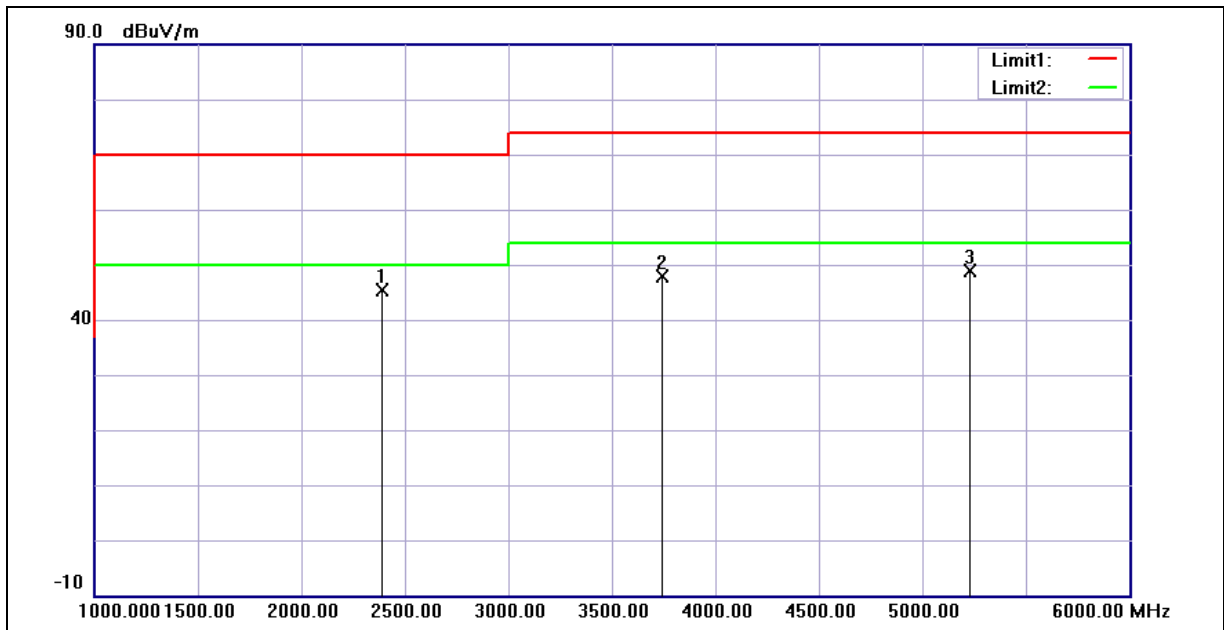

| No. | Frequency (MHz) | Reading (dBuV) | Correct Factor(dB/m) | Result (dBuV/m) | Limit (dBuV/m) | Margin (dB) | Remark |
|-----|-----------------|----------------|----------------------|-----------------|----------------|-------------|--------|
| 1 | 2390.000 | 45.68 | -0.22 | 45.46 | 70.00 | -24.54 | peak |
| 2 | 3745.000 | 43.55 | 4.35 | 47.90 | 74.00 | -26.10 | peak |
| 3 | 5230.000 | 39.79 | 9.18 | 48.97 | 74.00 | -25.03 | peak |

| | | | |
|--------------------|--------------------|-----------------------------|--------------|
| Standard: | EN 55022 Class B | Test Distance: | 3m |
| Test item: | Radiated Emission | Power: | AC 230V/50Hz |
| Model: | FE8171V | Temp.(°C)/Hum.(%RH): | 26(°C)/60%RH |
| Mode: | Mode 1 (1GHz~6GHz) | Date: | 2011/07/26 |
| Ant.Polar.: | Vertical | Test By: | Gary Wu |

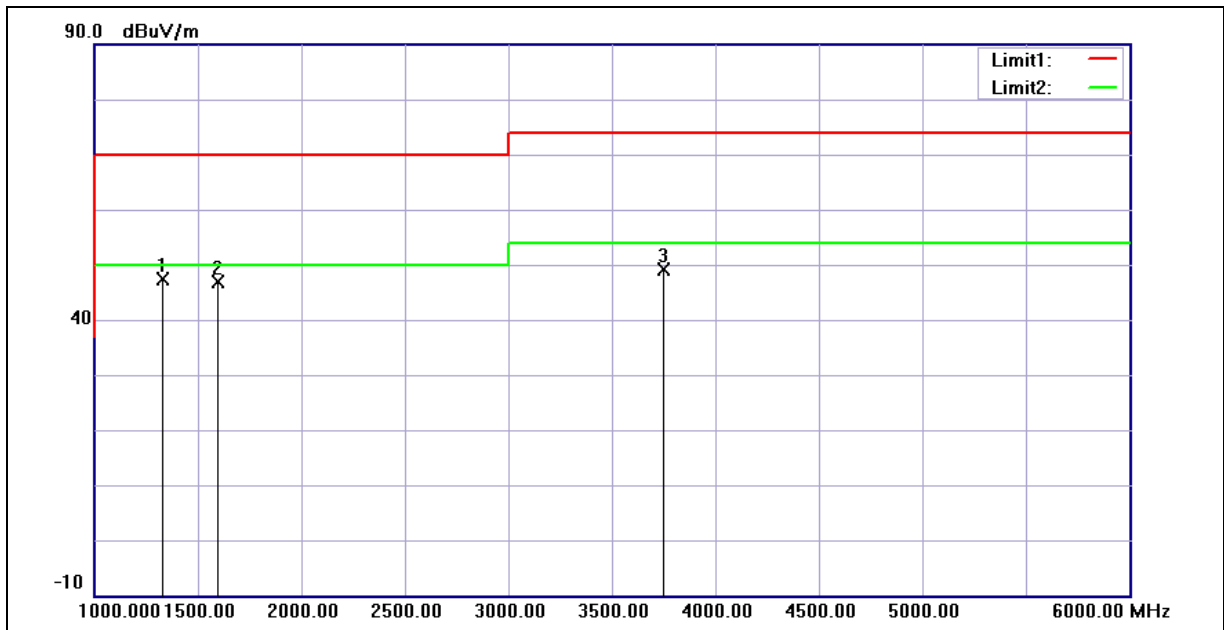

| No. | Frequency (MHz) | Reading (dBuV) | Correct Factor(dB/m) | Result (dBuV/m) | Limit (dBuV/m) | Margin (dB) | Remark |
|-----|-----------------|----------------|----------------------|-----------------|----------------|-------------|--------|
| 1 | 1330.000 | 51.84 | -4.51 | 47.33 | 70.00 | -22.67 | peak |
| 2 | 1595.000 | 50.17 | -3.22 | 46.95 | 70.00 | -23.05 | peak |
| 3 | 3750.000 | 44.87 | 4.37 | 49.24 | 74.00 | -24.76 | peak |

| | | | |
|--------------------|-------------------|-----------------------------|--------------|
| Standard: | EN 55022 Class B | Test Distance: | 10m |
| Test item: | Radiated Emission | Power: | DC 48V |
| Model: | FE8171V | Temp.(°C)/Hum.(%RH): | 26(°C)/60%RH |
| Mode: | Mode 2 | Date: | 2011/07/20 |
| Ant.Polar.: | Horizontal | Test By: | Gary Wu |

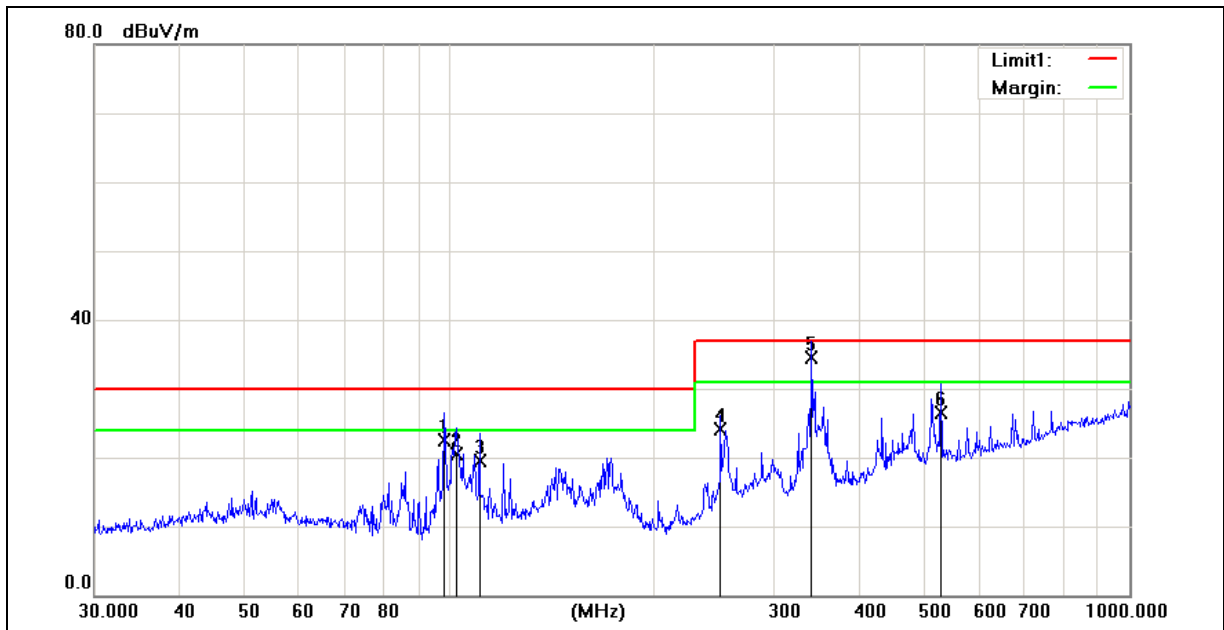

| No. | Frequency (MHz) | Reading (dBuV) | Correct Factor(dB/m) | Result (dBuV/m) | Limit (dBuV/m) | Margin (dB) | Height (cm) | Degree (°) | Remark |
|-----|-----------------|----------------|----------------------|-----------------|----------------|-------------|-------------|------------|--------|
| 1 | 98.1420 | 39.84 | -17.24 | 22.60 | 30.00 | -7.40 | 400 | 123 | QP |
| 2 | 102.3597 | 36.97 | -16.47 | 20.50 | 30.00 | -9.50 | 400 | 98 | QP |
| 3 | 110.5687 | 34.57 | -15.07 | 19.50 | 30.00 | -10.50 | 400 | 130 | QP |
| 4 | 250.3012 | 37.07 | -12.87 | 24.20 | 37.00 | -12.80 | 400 | 74 | QP |
| 5 | 340.7817 | 44.77 | -10.27 | 34.50 | 37.00 | -2.50 | 300 | 246 | QP |
| 6 | 528.2458 | 33.14 | -6.54 | 26.60 | 37.00 | -10.40 | 400 | 274 | QP |

| | | | |
|--------------------|-------------------|-----------------------------|--------------|
| Standard: | EN 55022 Class B | Test Distance: | 10m |
| Test item: | Radiated Emission | Power: | DC 48V |
| Model: | FE8171V | Temp.(°C)/Hum.(%RH): | 26(°C)/60%RH |
| Mode: | Mode 2 | Date: | 2011/07/20 |
| Ant.Polar.: | Vertical | Test By: | Gary Wu |

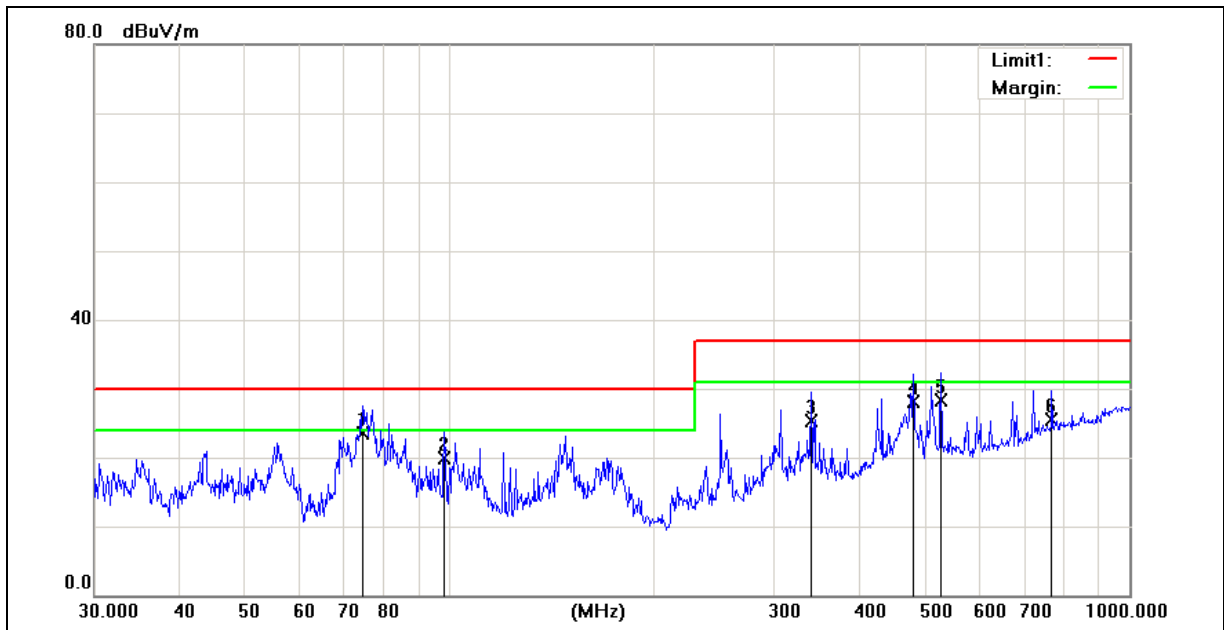

| No. | Frequency (MHz) | Reading (dBuV) | Correct Factor(dB/m) | Result (dBuV/m) | Limit (dBuV/m) | Margin (dB) | Height (cm) | Degree (°) | Remark |
|-----|-----------------|----------------|----------------------|-----------------|----------------|-------------|-------------|------------|--------|
| 1 | 74.3955 | 40.64 | -17.04 | 23.60 | 30.00 | -6.40 | 200 | 266 | QP |
| 2 | 98.1420 | 37.04 | -17.14 | 19.90 | 30.00 | -10.10 | 400 | 330 | QP |
| 3 | 340.7817 | 34.75 | -9.45 | 25.30 | 37.00 | -11.70 | 200 | 0 | QP |
| 4 | 480.5276 | 34.25 | -6.15 | 28.10 | 37.00 | -8.90 | 100 | 216 | QP |
| 5 | 528.2458 | 33.50 | -5.20 | 28.30 | 37.00 | -8.70 | 100 | 74 | QP |
| 6 | 768.7481 | 24.75 | 0.75 | 25.50 | 37.00 | -11.50 | 400 | 22 | QP |

| | | | |
|--------------------|--------------------|-----------------------------|--------------|
| Standard: | EN 55022 Class B | Test Distance: | 3m |
| Test item: | Radiated Emission | Power: | DC 48V |
| Model: | FE8171V | Temp.(°C)/Hum.(%RH): | 26(°C)/60%RH |
| Mode: | Mode 2 (1GHz~6GHz) | Date: | 2011/07/26 |
| Ant.Polar.: | Horizontal | Test By: | Gary Wu |

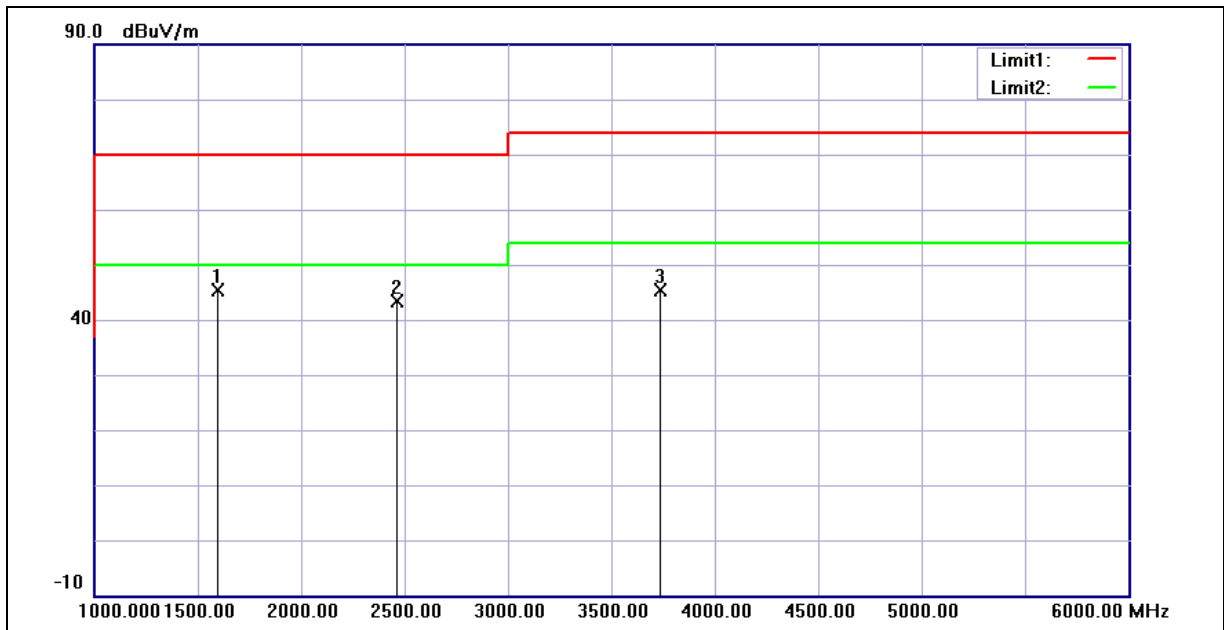

| No. | Frequency (MHz) | Reading (dBuV) | Correct Factor(dB/m) | Result (dBuV/m) | Limit (dBuV/m) | Margin (dB) | Remark |
|-----|-----------------|----------------|----------------------|-----------------|----------------|-------------|--------|
| 1 | 1595.000 | 48.65 | -3.22 | 45.43 | 70.00 | -24.57 | peak |
| 2 | 2465.000 | 43.30 | 0.09 | 43.39 | 70.00 | -26.61 | peak |
| 3 | 3735.000 | 40.96 | 4.32 | 45.28 | 74.00 | -28.72 | peak |

| | | | |
|--------------------|--------------------|-----------------------------|--------------|
| Standard: | EN 55022 Class B | Test Distance: | 3m |
| Test item: | Radiated Emission | Power: | DC 48V |
| Model: | FE8171V | Temp.(°C)/Hum.(%RH): | 26(°C)/60%RH |
| Mode: | Mode 2 (1GHz~6GHz) | Date: | 2011/07/26 |
| Ant.Polar.: | Vertical | Test By: | Gary Wu |

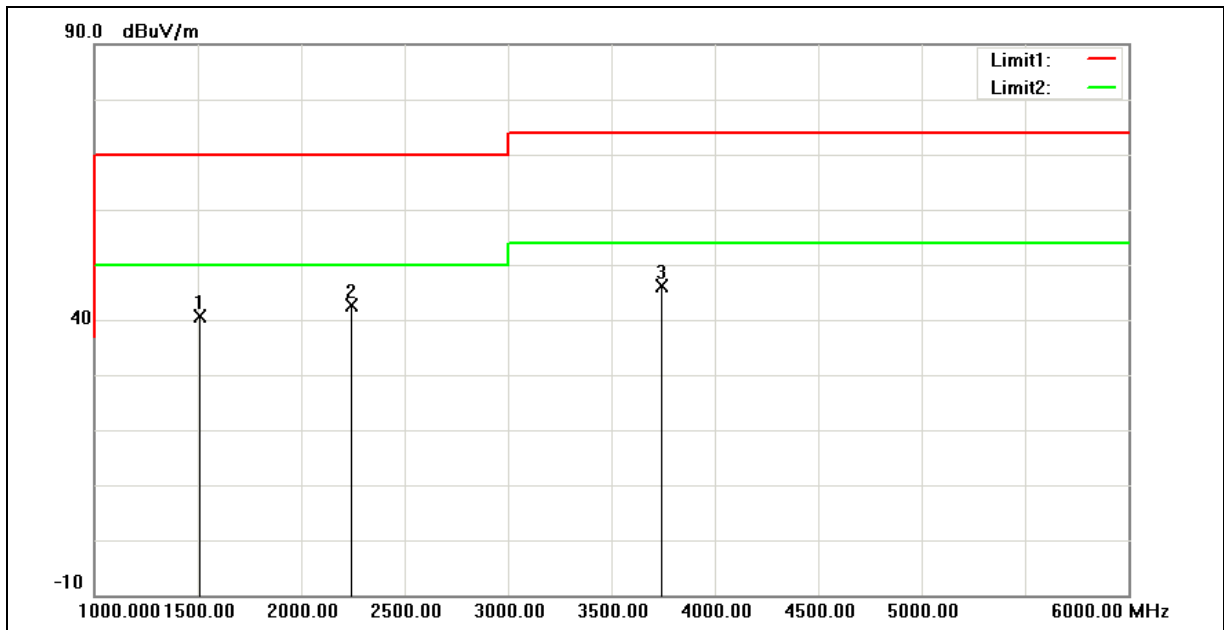

| No. | Frequency (MHz) | Reading (dBuV) | Correct Factor(dB/m) | Result (dBuV/m) | Limit (dBuV/m) | Margin (dB) | Remark |
|-----|-----------------|----------------|----------------------|-----------------|----------------|-------------|--------|
| 1 | 1510.000 | 44.11 | -3.52 | 40.59 | 70.00 | -29.41 | peak |
| 2 | 2245.000 | 43.40 | -0.80 | 42.60 | 70.00 | -27.40 | peak |
| 3 | 3745.000 | 41.68 | 4.35 | 46.03 | 74.00 | -27.97 | peak |

4.2.6. Test Photograph

Test Mode : Mode 1

Description : Front View of Radiated Emission Test_Below 1GHz

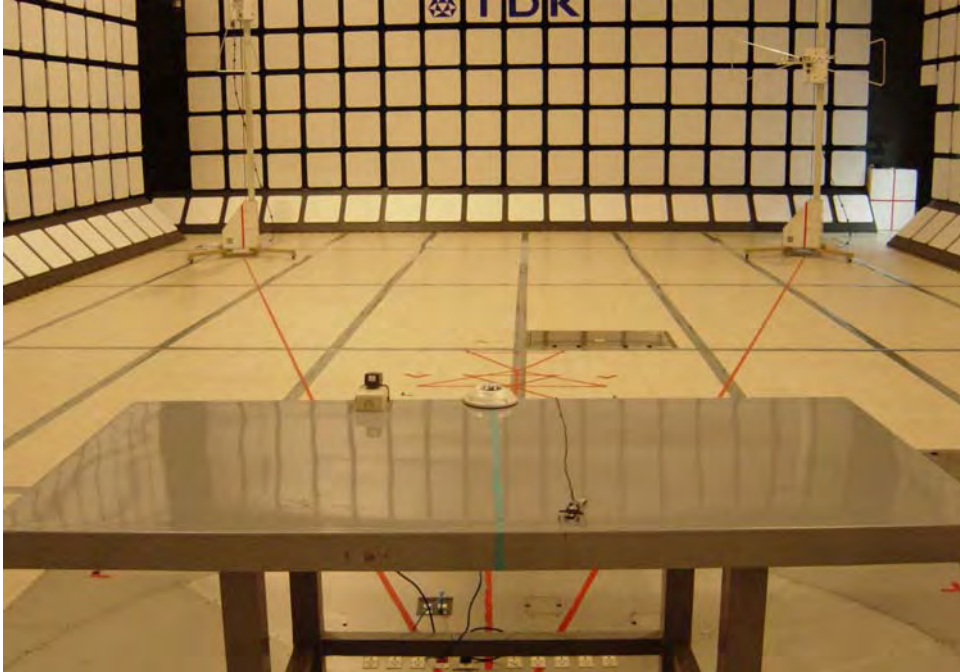

Test Mode : Mode 1

Description : Back View of Radiated Emission Test_Below 1GHz

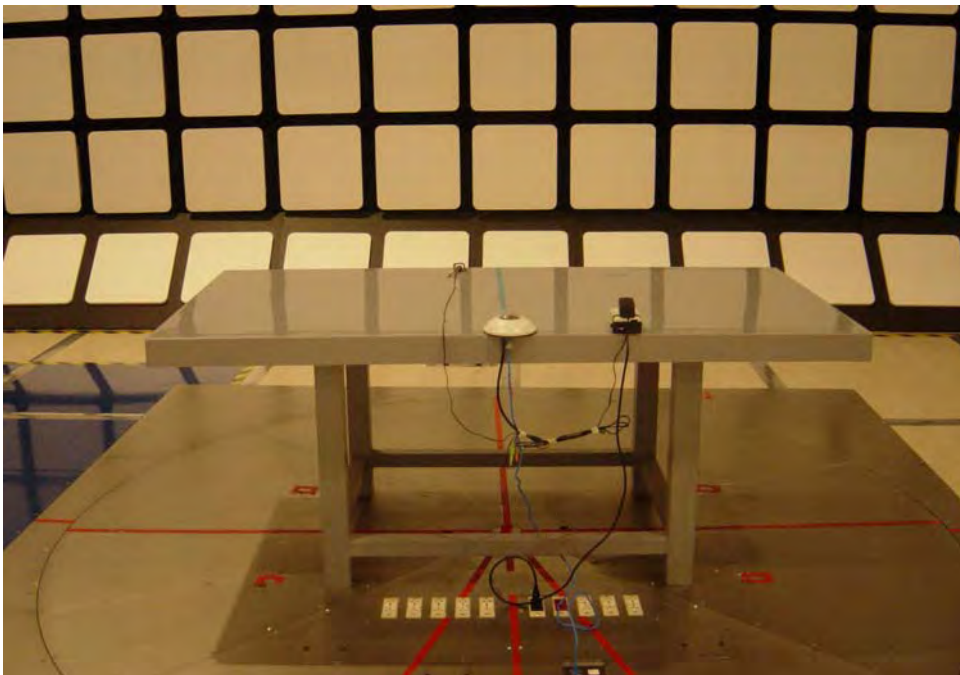

Test Mode : Mode 2

Description : Front View of Radiated Emission Test_Below 1GHz

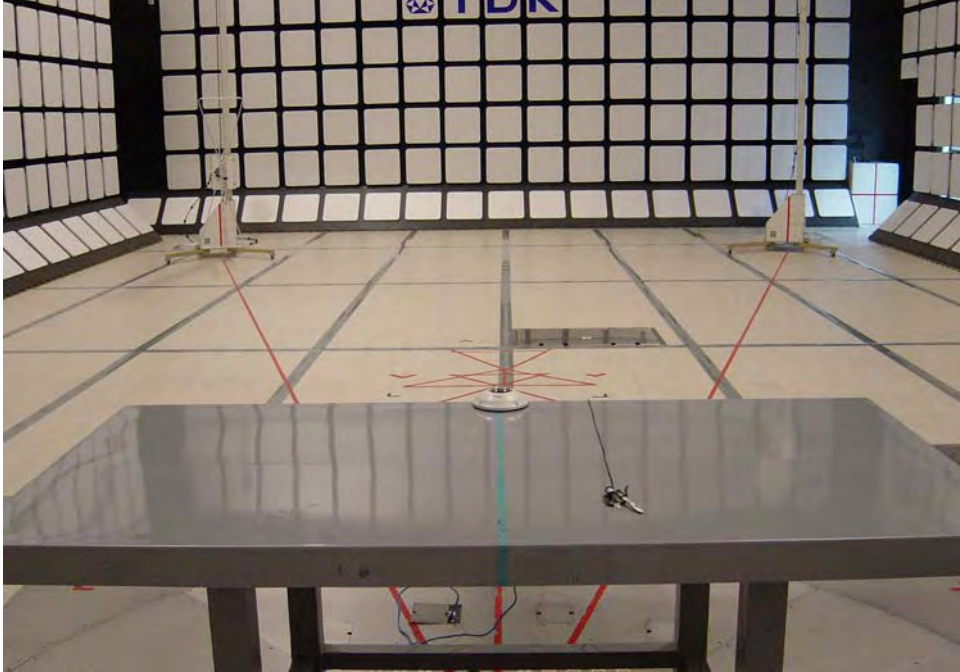

Test Mode : Mode 2

Description : Back View of Radiated Emission Test_Below 1GHz

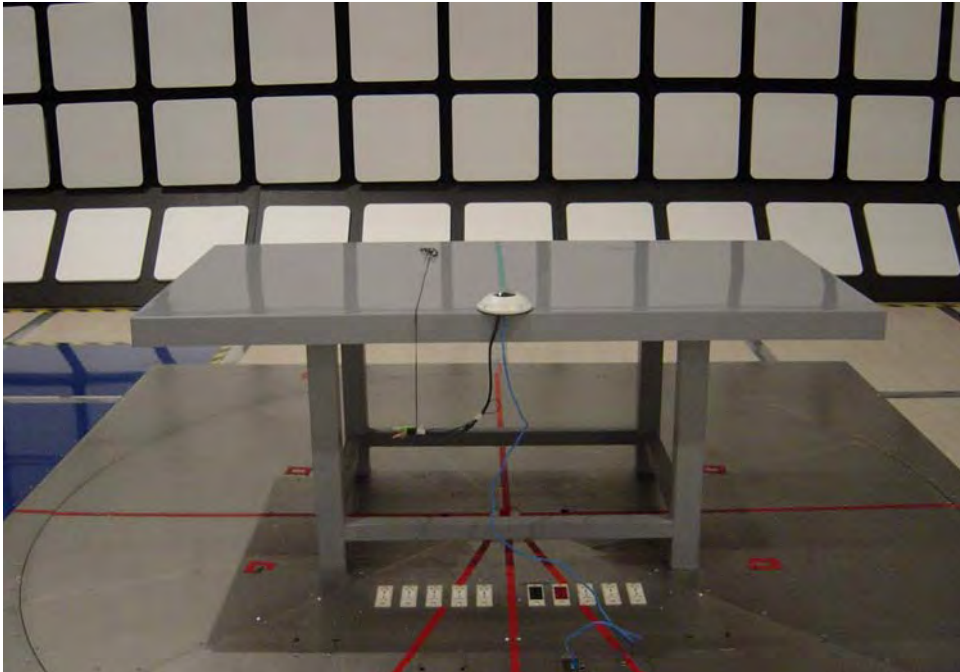

Test Mode : Mode 1

Description : Front View of Radiated Emission Test_Above 1GHz

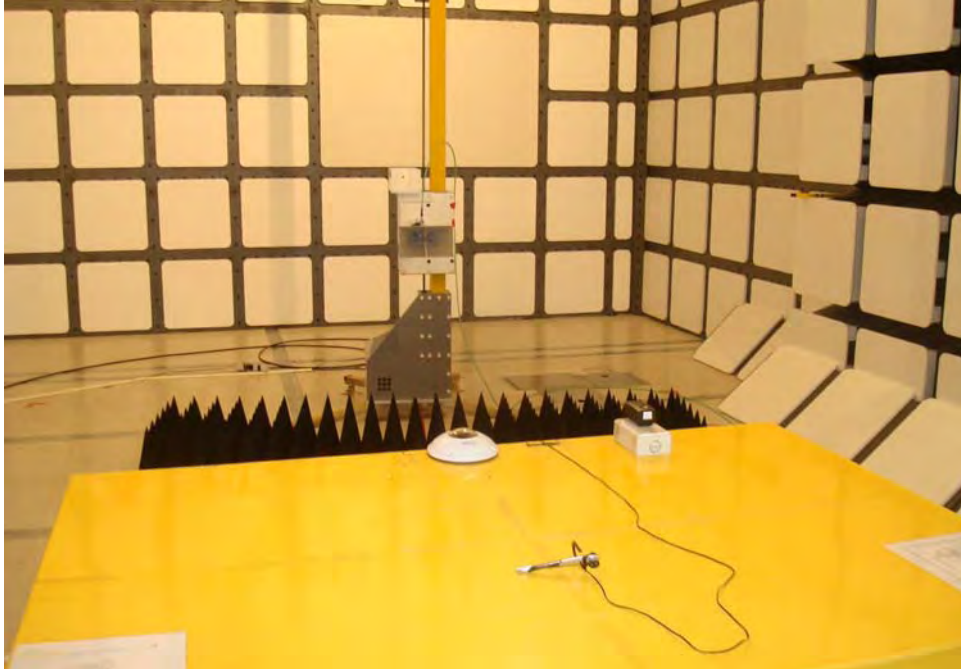

Test Mode : Mode 1

Description : Back View of Radiated Emission Test_Above 1GHz

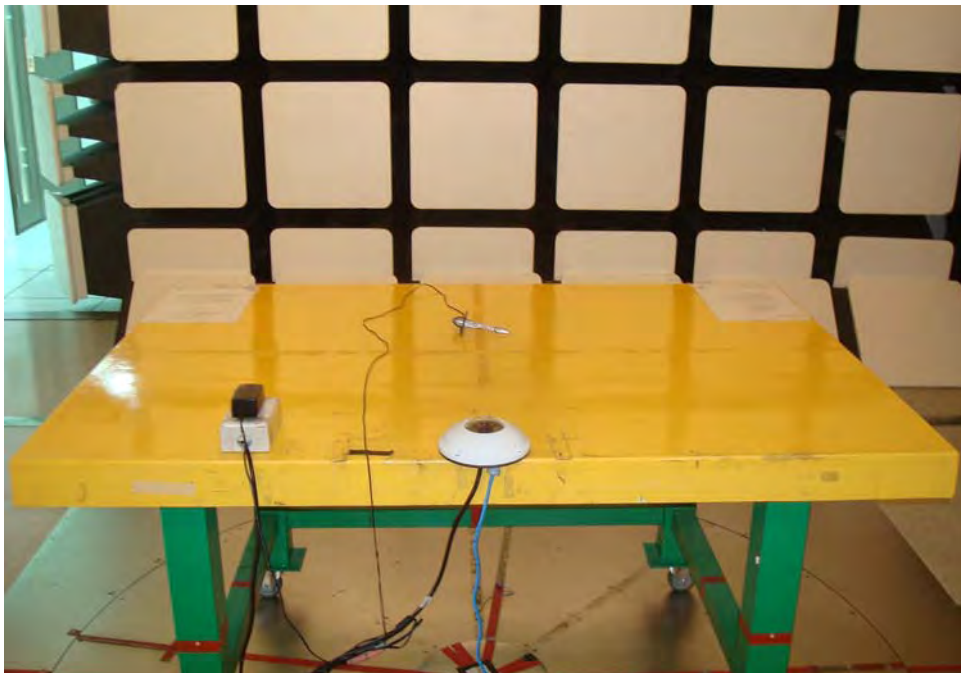

Test Mode : Mode 2

Description : Front View of Radiated Emission Test_Above 1GHz

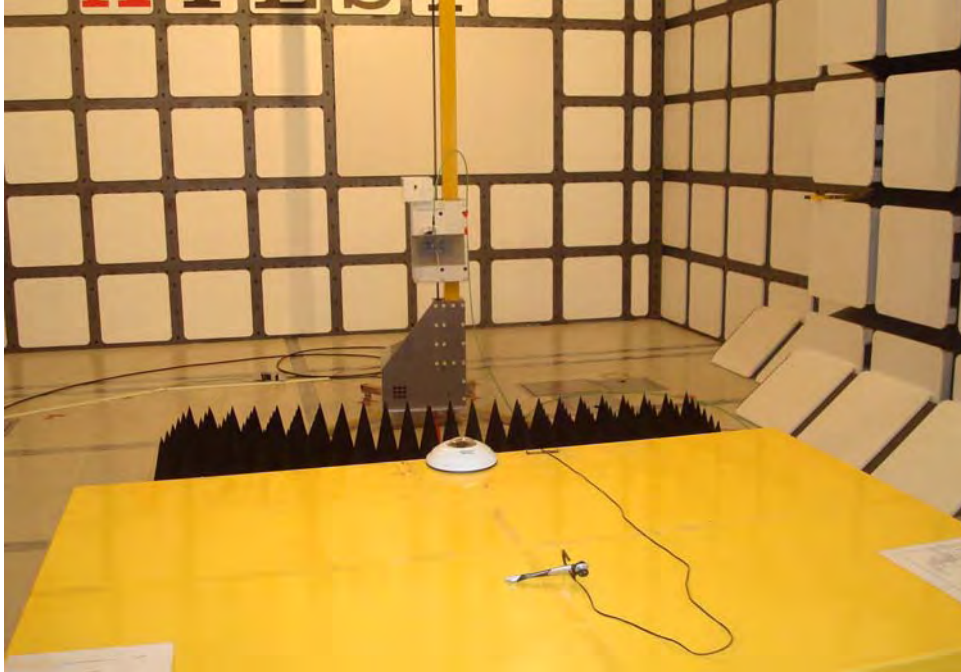

Test Mode : Mode 2

Description : Back View of Radiated Emission Test_Above 1GHz

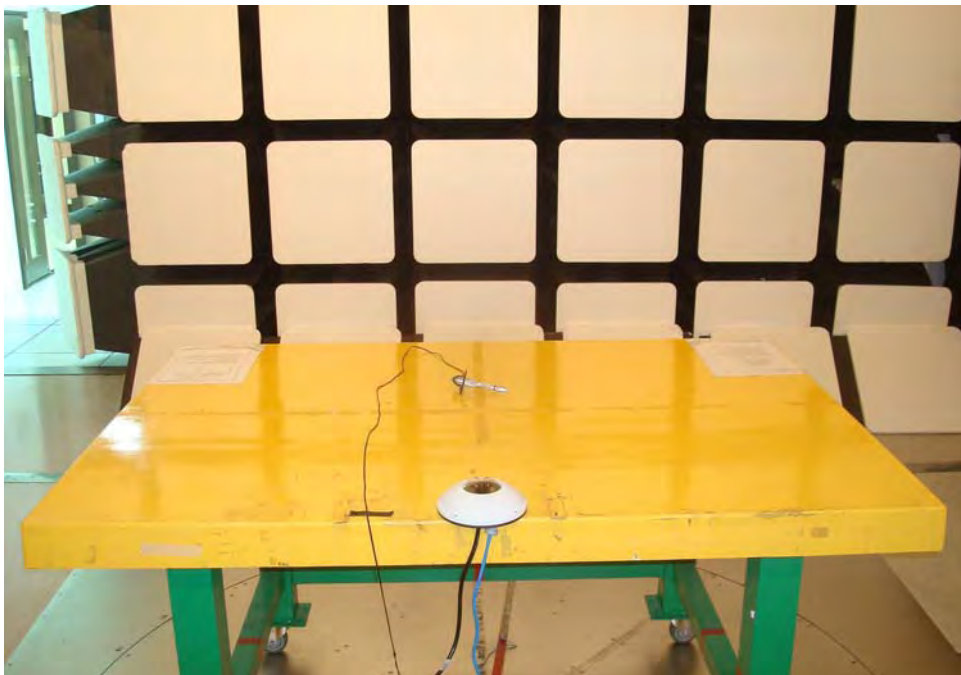

4.3. Harmonics Current Measurement

4.3.1. Limit

Limits of Class A Harmonics Currents

| Harmonics Order n | Maximum Permissible harmonic current (A) | Harmonics Order n | Maximum Permissible harmonic current (A) |
|----------------------|---|----------------------|---|
| Odd harmonics | | Even harmonics | |
| 3 | 2.30 | 2 | 1.08 |
| 5 | 1.14 | 4 | 0.43 |
| 7 | 0.77 | 6 | 0.30 |
| 9 | 0.40 | 8 ≤ n ≤ 40 | 0.23 * 8/n |
| 11 | 0.33 | | |
| 13 | 0.21 | | |
| 15 ≤ n ≤ 39 | 0.15 * 15/n | | |

Limits of Class B Harmonics Currents

For Class B equipment, the harmonic of the input current shall not exceed the maximum permissible values given in table which is the limit of Class A multiplied by a factor of 1.5.

Limits of Class C Harmonics Currents

| Harmonics Order n | Maximum Permissible harmonic current Expressed as a percentage of the input current at the fundamental frequency (%) |
|-------------------------------------|--|
| 2 | 2 |
| 3 | 30 · λ* |
| 5 | 10 |
| 7 | 7 |
| 9 | 5 |
| 11 ≤ n ≤ 39 (odd harmonics only) | 3 |

* λ is the circuit power factor

Limits of Class D Harmonics Currents

| Harmonics Order n | Maximum Permissible harmonic current per watt (mA/W) | Maximum Permissible harmonic current (A) |
|-------------------------------------|---|---|
| 3 | 3.4 | 2.30 |
| 5 | 1.9 | 1.14 |
| 7 | 1.0 | 0.77 |
| 9 | 0.5 | 0.40 |
| 11 | 0.35 | 0.33 |
| 11 ≤ n ≤ 39 (odd harmonics only) | 3.85/n | See limit of Class A |

4.3.2. Test Instrument

| Equipment | Manufacturer | Model Number | Serial Number | Cal. Date | Remark |
|---------------------------|----------------|--------------|---------------|------------|--------|
| Power Harmonics Analyzers | EMC-Partner AG | HAR1000-1P | 171 | 02/07/2011 | (2) |
| Test Site | ATL | TE05 | TE05 | N.C.R. | ----- |

Remark: ⁽¹⁾ Calibration period 1 year. ⁽²⁾ Calibration period 2 years.

NOTE: N.C.R. = No Calibration Request.

4.3.3. Setup

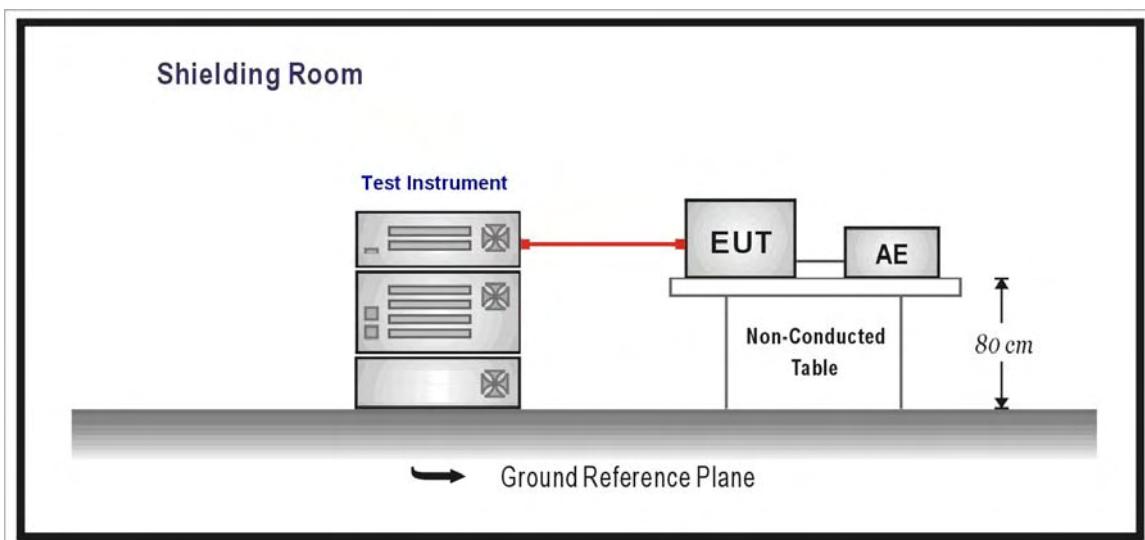

4.3.4. Test Procedure

The EUT was placed on the top of a wooden table 0.8 meters above the ground and the EUT is supplied in series with power analyzer from a power source having the same normal voltage and frequency as the rated supply voltage and the equipment under test. And the rated voltage at the supply voltage of EUT of 0.94 times and 1.06 times shall be performed.

A definition of the normal load or of the conditions for adequate heat discharge can usually be found in the EN publication corresponding to the equipment under test.

Equipment may have several separately controlled circuits. Each circuit is considered as a single piece of equipment if it can be operated independently and separately from the other circuits.

4.3.5. Test Result

| | | | |
|--------------|-----------------|-----------|------|
| Product | Network Camera | | |
| Test Item | Power Harmonics | | |
| Test Mode | Mode 1 | | |
| Date of Test | 07/22/2011 | Test Site | TE05 |

Test Result: Pass

Source qualification: Normal

Current & voltage waveforms

Harmonics and Class A limit line

European Limits

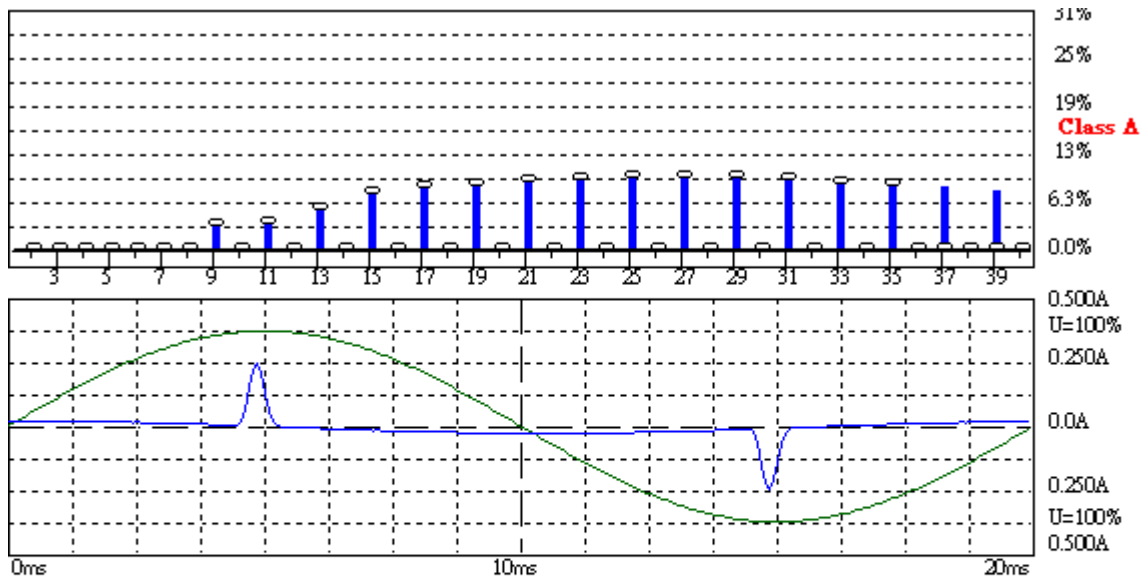

Harmonic Emission - IEC 61000-3-2 , EN 61000-3-2 , (CEN60555-2)

2011/7/22 PM 04:36:0

U_{rms} = 229.9 V P = 3.497 W THC = 0.042 A
 I_{rms} = 0.045 A pf = 0.339

Range: 0.5 A
 V-nom: 230 V
 TestTime: 1 min (100%)

11-0377-E
 DC IN

Test completed, Result: PASSED

HAR-1000 EMC-Retre

Note 1:

For the following categories of equipment limits are not specified in this edition of the standard.

- Equipment with a rated power of 75 W or less, other than lighting equipment.
- Professional equipment with a total rated power greater than 1 kW;
- Symmetrically controlled heating elements with a rated power less than or equal to 200 W;
- Independent dimmers for incandescent lamps with a rated power less than or equal to 1 kW.

Test result: **Pass** Worst harmonic was #0 with 0.00% of the limit.

| | | |
|---------------|---------------|--------------|
| Urms = 229.9V | Freq = 50.013 | Range: 0.5 A |
| Irms = 0.045A | Ipk = 0.284A | cf = 6.332 |
| P = 3.497W | S = 10.33VA | pf = 0.339 |
| THDi = 88.0 % | THDu = 0.10 % | Class A |

Test - Time : 1min (100 %)

Test completed, Result: **PASSED**

| Order | Freq. [Hz] | Iavg [A] | Iavg%L [%] | Imax [A] | Imax%L [%] | Limit [A] | Status |
|-------|---------------|-------------|---------------|-------------|---------------|--------------|--------|
| 1 | 50 | 0.0227 | | 0.0227 | | | |
| 2 | 100 | 0.0000 | 0.0000 | 0.0004 | 0.0396 | 1.0800 | Pass |
| 3 | 150 | 0.0128 | 0.5556 | 0.0128 | 0.5573 | 2.3000 | Pass |
| 4 | 200 | 0.0000 | 0.0000 | 0.0004 | 0.0994 | 0.4300 | Pass |
| 5 | 250 | 0.0127 | 1.1139 | 0.0127 | 1.1163 | 1.1400 | Pass |
| 6 | 300 | 0.0000 | 0.0000 | 0.0004 | 0.1424 | 0.3000 | Pass |
| 7 | 350 | 0.0125 | 1.6275 | 0.0126 | 1.6329 | 0.7700 | Pass |
| 8 | 400 | 0.0000 | 0.0000 | 0.0004 | 0.1858 | 0.2300 | Pass |
| 9 | 450 | 0.0123 | 3.0721 | 0.0123 | 3.0823 | 0.4000 | Pass |
| 10 | 500 | 0.0000 | 0.0000 | 0.0005 | 0.2488 | 0.1840 | Pass |
| 11 | 550 | 0.0120 | 3.6272 | 0.0120 | 3.6344 | 0.3300 | Pass |
| 12 | 600 | 0.0000 | 0.0000 | 0.0004 | 0.2786 | 0.1533 | Pass |
| 13 | 650 | 0.0116 | 5.5236 | 0.0116 | 5.5368 | 0.2100 | Pass |
| 14 | 700 | 0.0000 | 0.0000 | 0.0005 | 0.3483 | 0.1314 | Pass |
| 15 | 750 | 0.0112 | 7.4466 | 0.0112 | 7.4666 | 0.1500 | Pass |
| 16 | 800 | 0.0000 | 0.0000 | 0.0004 | 0.3715 | 0.1150 | Pass |
| 17 | 850 | 0.0107 | 8.0827 | 0.0107 | 8.0933 | 0.1324 | Pass |
| 18 | 900 | 0.0000 | 0.0000 | 0.0004 | 0.4180 | 0.1022 | Pass |
| 19 | 950 | 0.0102 | 8.6002 | 0.0102 | 8.6331 | 0.1184 | Pass |
| 20 | 1000 | 0.0000 | 0.0000 | 0.0004 | 0.4644 | 0.0920 | Pass |
| 21 | 1050 | 0.0096 | 8.9913 | 0.0096 | 9.0007 | 0.1071 | Pass |
| 22 | 1100 | 0.0000 | 0.0000 | 0.0004 | 0.5108 | 0.0836 | Pass |
| 23 | 1150 | 0.0091 | 9.2574 | 0.0091 | 9.2963 | 0.0978 | Pass |
| 24 | 1200 | 0.0000 | 0.0000 | 0.0004 | 0.5175 | 0.0767 | Pass |
| 25 | 1250 | 0.0085 | 9.3911 | 0.0085 | 9.4265 | 0.0900 | Pass |
| 26 | 1300 | 0.0000 | 0.0000 | 0.0004 | 0.5606 | 0.0708 | Pass |
| 27 | 1350 | 0.0078 | 9.4131 | 0.0079 | 9.4482 | 0.0833 | Pass |
| 28 | 1400 | 0.0000 | 0.0000 | 0.0004 | 0.6037 | 0.0657 | Pass |
| 29 | 1450 | 0.0072 | 9.3132 | 0.0073 | 9.3614 | 0.0776 | Pass |
| 30 | 1500 | 0.0000 | 0.0000 | 0.0004 | 0.5971 | 0.0613 | Pass |
| 31 | 1550 | 0.0066 | 9.1115 | 0.0067 | 9.1661 | 0.0726 | Pass |
| 32 | 1600 | 0.0000 | 0.0000 | 0.0004 | 0.6369 | 0.0575 | Pass |
| 33 | 1650 | 0.0060 | 8.8077 | 0.0060 | 8.8623 | 0.0682 | Pass |
| 34 | 1700 | 0.0000 | 0.0000 | 0.0004 | 0.6767 | 0.0541 | Pass |
| 35 | 1750 | 0.0054 | 8.4140 | 0.0055 | 8.4974 | 0.0643 | Pass |
| 36 | 1800 | 0.0000 | 0.0000 | 0.0003 | 0.6568 | 0.0511 | Pass |
| 37 | 1850 | 0.0000 | 0.0000 | 0.0049 | 8.0295 | 0.0608 | Pass |
| 38 | 1900 | 0.0000 | 0.0000 | 0.0003 | 0.6933 | 0.0484 | Pass |
| 39 | 1950 | 0.0000 | 0.0000 | 0.0043 | 7.5114 | 0.0577 | Pass |
| 40 | 2000 | 0.0000 | 0.0000 | 0.0003 | 0.6634 | 0.0460 | Pass |

1. Dynamic limits were applied for this test. The highest harmonics values in the above table may not occur at the same window as the maximum harmonics/limit ratio.

2. According to EN61000-3-2 paragraph 7 the note 1 and 2 are valid for all applications having an active input power >75W. Others the result should be pass.

4.3.6. Test Photograph

Test Mode : Mode 1

Description : Power Harmonics Test Setup



4.4. Voltage Fluctuation and Flicker

4.4.1. Limit

The following limits apply:

- the value of P_{st} shall not be greater than 1.0;
- the value of P_{1t} shall not be greater than 0.65;
- the value of $d(t)$ during a voltage change shall not exceed 3.3 % for more than 500 ms;
- the relative steady-state voltage change, d_c , shall not exceed 3.3 %;
- the maximum relative voltage change, d_{max} , shall not exceed;
 - a) 4 % without additional conditions;
 - b) 6 % for equipment which is:
 - switched manually, or
 - switched automatically more frequently than twice per day, and also has either a delayed restart (the delay being not less than a few tens of seconds), or manual restart, after a power supply interruption.

Note: The cycling frequency will be further limited by the P_{st} and P_{1t} limit.

For example: a d_{max} of 6% producing a rectangular voltage change characteristic twice per hour will give a P_{1t} of about 0.65.

- c) 7 % for equipment which is:
 - attended whilst in use (for example: hair dryers, vacuum cleaners, kitchen equipment such as mixers, garden equipment such as lawn mowers, portable tools such as electric drills), or
 - switched on automatically, or is intended to be switched on manually, no more than twice per day, and also has either a delayed restart (the delay being not less than a few tens of seconds) or manual restart, after a power supply interruption.

P_{st} and P_{1t} requirements shall not be applied to voltage changes caused by manual switching.

4.4.2. Test Instrument

| Equipment | Manufacturer | Model Number | Serial Number | Cal. Date | Remark |
|---------------------------|----------------|--------------|---------------|------------|--------|
| Power Harmonics Analyzers | EMC-Partner AG | HAR1000-1P | 171 | 02/07/2011 | (2) |
| Test Site | ATL | TE05 | TE05 | N.C.R. | ----- |

Remark: ⁽¹⁾ Calibration period 1 year. ⁽²⁾ Calibration period 2 years.

NOTE: N.C.R. = No Calibration Request.

4.4.3. Setup

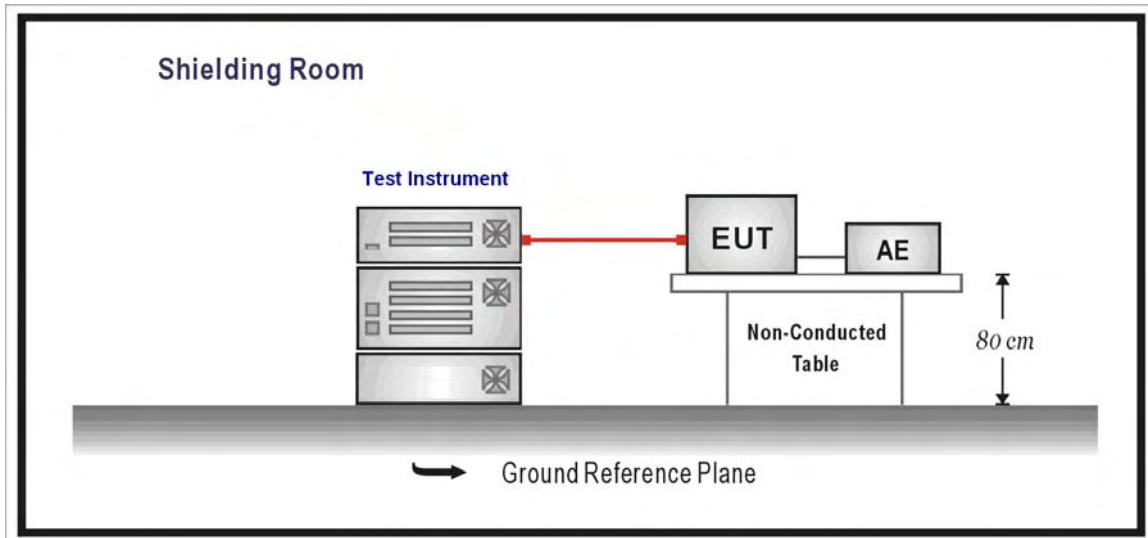

4.4.4. Test Procedure

The EUT is supplied in series with power analyzer from a power source having the same normal voltage and frequency as the rated supply voltage and the equipment under test. And the rated voltage at the supply voltage of EUT of 0.94 times and 1.06 times shall be performed.

The EUT was placed on the top of a wooden table 0.8 meters above the ground and operated to produce the most unfavorable sequence of voltage changes under normal operating conditions.

During the flicker measurement, the measure time shall include that part of whole operation cycle in which the EUT produce the most unfavorable sequence of voltage changes. The observation period for short-term flicker indicator is 10 minutes and the observation period for long-term flicker indicator is 2 hours.

4.4.5. Test Result

| | | | |
|--------------|----------------|-----------|------|
| Product | Network Camera | | |
| Test Item | Flicker | | |
| Test Mode | Mode 1 | | |
| Date of Test | 07/22/2011 | Test Site | TE05 |

Test Result: Pass

Status: Test Completed

Plt and limit line

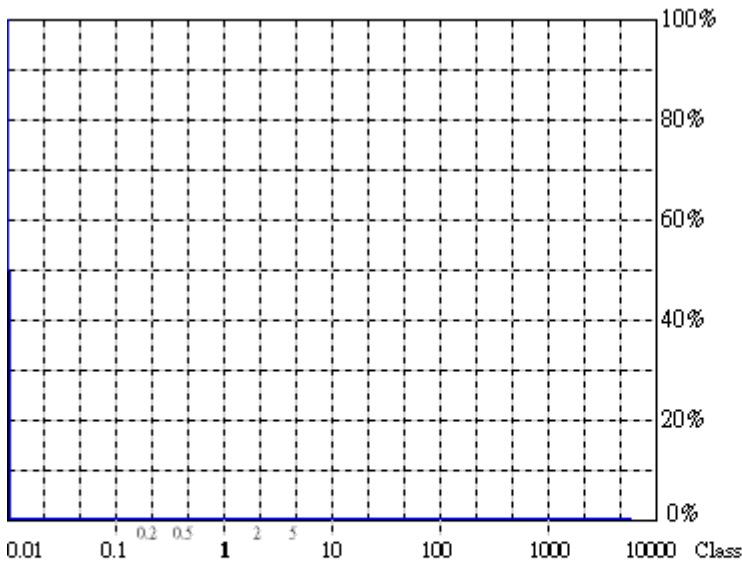

| | |
|---|---------------|
| Actual Flicker (Fli): | 0.00 |
| Short-term Flicker (Pst): | 0.07 |
| Limit (Pst): | 1.00 |
| Long-term Flicker (Plt): | 0.07 |
| Limit (Plt): | 0.65 |
| Maximum Relative Volt. Change (dmax): | 0.00% |
| Limit (dmax): | 4.00% |
| Relative Steady-state Voltage Change (dc): | 0.02% |
| Limit (dc): | 3.30% |
| Maximum Interval exceeding 3.30% (dt): | 0.00ms |
| Limit (dt>Lim): | 500ms |

Flicker Emission - IEC 61000-3-3 , EN 61000-3-3 , (CEN60555-3)

2011/7/22 PM 04:52:1

Urms = 229.9 V P = 3.485 W
 Irms = 0.042 A pf = 0.357

Range: 0.5 A
 V-nom: 230 V
 TestTime: 10 min (100%)

11-0377-E
 DC IN

Test completed, Result: PASSED

HAR-1000 EMC-Retre

Urms = 229.9V Freq = 50.000 Range: 0.5 A
 Irms = 0.042A lpk = 0.246A cf = 5.782
 P = 3.485W S = 9.767VA pf = 0.357

Test - Time : 1 x 10min = 10min (100 %)

LIN (Line Impedance Network) : L: 0.24ohm +j0.15ohm N: 0.16ohm +j0.10ohm

Limits : Plt : 0.65 Pst : 1.00
 dmax : 4.00 % dc : 3.30 %
 dtLim: 3.30 % dt>Lim: 500ms

Test completed, Result: PASSED

4.4.6. Test Photograph

Test Mode : Mode 1

Description : Flicker Test Setup



5 Immunity Test

5.1. Electrostatic Discharge (ESD)

5.1.1. Test Specification

| IEC 61000-4-2 | | | |
|-------------------------|---------------------|--|-----------------------|
| Environmental Phenomena | Units | Test Specification | Performance Criterion |
| Enclosure Port | | | |
| Electrostatic Discharge | kV (Charge Voltage) | ±8 Air Discharge ±4 Contact Discharge | B |

5.1.2. Test Instrument

| Equipment | Manufacturer | Model Number | Serial Number | Cal. Date | Remark |
|--------------------------|--------------|--------------|------------------|------------|--------|
| Discharge Gun | Noiseken | ESS-2002 | NOISE-ESS-2002CM | 03/15/2011 | (1) |
| 0.8m Height Wooden Table | N/A | N/A | N/A | N.C.R. | ---- |
| Test Site | ATL | TE04 | TE04 | N.C.R. | ---- |

Remark: ⁽¹⁾ Calibration period 1 year. ⁽²⁾ Calibration period 2 years.

NOTE: N.C.R. = No Calibration Request.

5.1.3. Setup

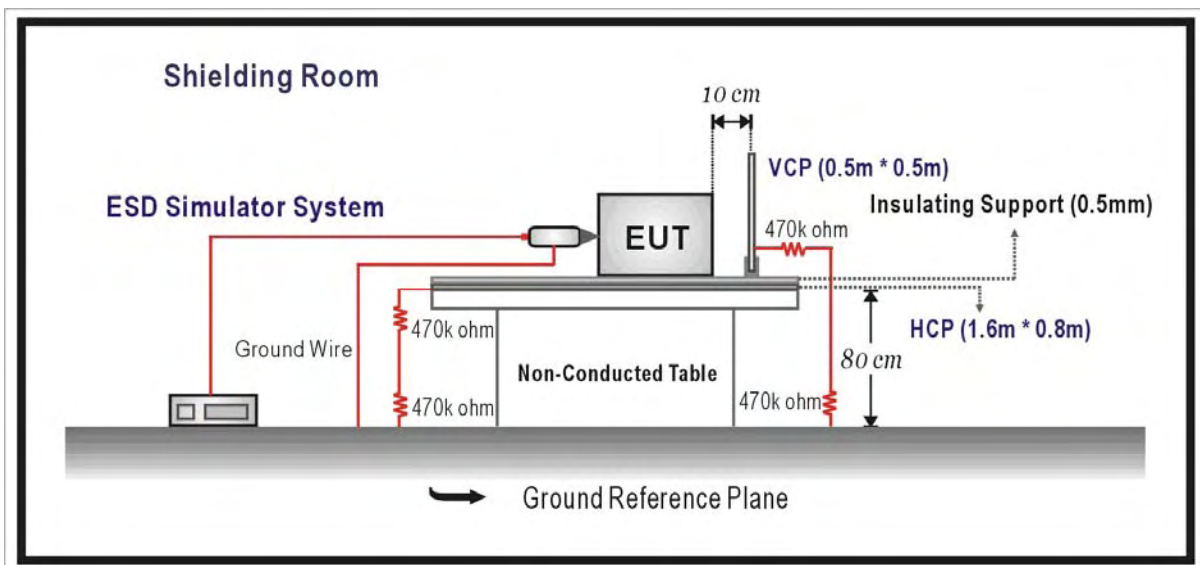

5.1.4. Test Procedure

The discharges shall be applied in two ways:

- a) Contact discharges to the conductive surfaces and coupling planes:

The EUT shall be exposed to at least 200 discharges, 100 each at negative and positive polarity, at a minimum of four test points. One of the test points shall be subjected to at least 50 indirect discharges to the center of the front edge of the Horizontal Coupling Plane (HCP). The remaining three test points shall each receive at least 50 direct contact discharges. If no direct contact test point be available, then at least 200 indirect discharges shall be applied in the indirect mode. Test shall be performed at a maximum repetition rate of one discharge per second.

- b) Air discharges at slots and apertures and insulating surfaces:

On those parts of the EUT where it is not possible to perform contact discharge testing, the equipment should be investigated to identify user accessible points where breakdown may occur. Such points are tested using the air discharge method. This investigation should be restricted to those area normally handled by the user. A minimum of 10 single air discharges shall be applied to the selected test point for each such area.

The basic test procedure was in accordance with IEC 61000-4-2:

- a) The EUT was located 0.1 m minimum from all side of the HCP (dimensions 1.6m x 0.8m).
- b) The support units were located another table 30 cm away from the EUT, but direct support unit was/were located at same location as EUT on the HCP and keep at a distance of 10 cm with EUT.
- c) The time interval between two successive single discharges was at least 1 second.
- d) Contact discharges were applied to the non-insulating coating, with the pointed tip of the generator penetrating the coating and contacting the conducting substrate.
- e) Air discharges were applied with the round discharge tip of the discharge electrode approaching the EUT as fast as possible (without causing mechanical damage) to touch the EUT. After each discharge, the ESD generator was removed from the EUT and re-triggered for a new single discharge. The test was repeated until all discharges were complete.
- f) At least ten single discharges (in the most sensitive polarity) were applied at the front edge of each HCP opposite the center point of each unit of the EUT and 0.1 meters from the front of the EUT. The long axis of the discharge electrode was in the plane of the HCP and perpendicular to its front edge during the discharge.
- g) At least ten single discharges (in the most sensitive polarity) were applied to the center of one vertical edge of the Vertical Coupling Plane (VCP) in sufficiently different positions that the four faces of the EUT were completely illuminated. The VCP (dimensions 0.5m x 0.5m) was placed vertically to and 0.1 meters from the EUT.

5.1.5. Test Result

| | | | |
|--------------|-------------------------|-----------|------|
| Product | Network Camera | | |
| Test Item | Electrostatic Discharge | | |
| Test Mode | Mode 1 | | |
| Date of Test | 07/27/2011 | Test Site | TE04 |

| Air Discharge | | | | | | | | | | | | |
|---------------|-------------------------------------|---------------------------------------|----------------------------|-------------------------------------|---------------------------------------|----------------------------|-------------------------------------|---------------------------------------|----------------------------|-------------------------------------|--------------------------|-------------|
| Test Points | Test Levels | | | | | | Results | | | | | |
| | ± 2 kV | Performance Criterion | | ± 4 kV | Performance Criterion | | ± 8 kV | Performance Criterion | | Pass | Fail | Observation |
| Front | <input checked="" type="checkbox"/> | <input checked="" type="checkbox"/> A | <input type="checkbox"/> B | <input checked="" type="checkbox"/> | <input checked="" type="checkbox"/> A | <input type="checkbox"/> B | <input checked="" type="checkbox"/> | <input checked="" type="checkbox"/> A | <input type="checkbox"/> B | <input checked="" type="checkbox"/> | <input type="checkbox"/> | --- |
| Back | <input checked="" type="checkbox"/> | <input checked="" type="checkbox"/> A | <input type="checkbox"/> B | <input checked="" type="checkbox"/> | <input checked="" type="checkbox"/> A | <input type="checkbox"/> B | <input checked="" type="checkbox"/> | <input checked="" type="checkbox"/> A | <input type="checkbox"/> B | <input checked="" type="checkbox"/> | <input type="checkbox"/> | --- |
| Left | <input type="checkbox"/> | <input type="checkbox"/> A | <input type="checkbox"/> B | <input type="checkbox"/> | <input type="checkbox"/> A | <input type="checkbox"/> B | <input type="checkbox"/> | <input type="checkbox"/> A | <input type="checkbox"/> B | <input type="checkbox"/> | <input type="checkbox"/> | --- |
| Right | <input type="checkbox"/> | <input type="checkbox"/> A | <input type="checkbox"/> B | <input type="checkbox"/> | <input type="checkbox"/> A | <input type="checkbox"/> B | <input type="checkbox"/> | <input type="checkbox"/> A | <input type="checkbox"/> B | <input type="checkbox"/> | <input type="checkbox"/> | --- |
| Top | <input type="checkbox"/> | <input type="checkbox"/> A | <input type="checkbox"/> B | <input type="checkbox"/> | <input type="checkbox"/> A | <input type="checkbox"/> B | <input type="checkbox"/> | <input type="checkbox"/> A | <input type="checkbox"/> B | <input type="checkbox"/> | <input type="checkbox"/> | --- |
| Bottom | <input type="checkbox"/> | <input type="checkbox"/> A | <input type="checkbox"/> B | <input type="checkbox"/> | <input type="checkbox"/> A | <input type="checkbox"/> B | <input type="checkbox"/> | <input type="checkbox"/> A | <input type="checkbox"/> B | <input type="checkbox"/> | <input type="checkbox"/> | --- |

| Contact Discharge | | | | | | | | | | | | |
|-------------------|-------------------------------------|---------------------------------------|----------------------------|-------------------------------------|---------------------------------------|----------------------------|--------------------------|----------------------------|----------------------------|-------------------------------------|--------------------------|-------------|
| Test Points | Test Levels | | | | | | Results | | | | | |
| | ± 2 kV | Performance Criterion | | ± 4 kV | Performance Criterion | | ± 8 kV | Performance Criterion | | Pass | Fail | Observation |
| Front | <input checked="" type="checkbox"/> | <input checked="" type="checkbox"/> A | <input type="checkbox"/> B | <input checked="" type="checkbox"/> | <input checked="" type="checkbox"/> A | <input type="checkbox"/> B | <input type="checkbox"/> | <input type="checkbox"/> A | <input type="checkbox"/> B | <input checked="" type="checkbox"/> | <input type="checkbox"/> | --- |
| Back | <input checked="" type="checkbox"/> | <input checked="" type="checkbox"/> A | <input type="checkbox"/> B | <input checked="" type="checkbox"/> | <input checked="" type="checkbox"/> A | <input type="checkbox"/> B | <input type="checkbox"/> | <input type="checkbox"/> A | <input type="checkbox"/> B | <input checked="" type="checkbox"/> | <input type="checkbox"/> | --- |
| Left | <input type="checkbox"/> | <input type="checkbox"/> A | <input type="checkbox"/> B | <input type="checkbox"/> | <input type="checkbox"/> A | <input type="checkbox"/> B | <input type="checkbox"/> | <input type="checkbox"/> A | <input type="checkbox"/> B | <input type="checkbox"/> | <input type="checkbox"/> | --- |
| Right | <input type="checkbox"/> | <input type="checkbox"/> A | <input type="checkbox"/> B | <input type="checkbox"/> | <input type="checkbox"/> A | <input type="checkbox"/> B | <input type="checkbox"/> | <input type="checkbox"/> A | <input type="checkbox"/> B | <input type="checkbox"/> | <input type="checkbox"/> | --- |
| Top | <input type="checkbox"/> | <input type="checkbox"/> A | <input type="checkbox"/> B | <input type="checkbox"/> | <input type="checkbox"/> A | <input type="checkbox"/> B | <input type="checkbox"/> | <input type="checkbox"/> A | <input type="checkbox"/> B | <input type="checkbox"/> | <input type="checkbox"/> | --- |
| Bottom | <input type="checkbox"/> | <input type="checkbox"/> A | <input type="checkbox"/> B | <input type="checkbox"/> | <input type="checkbox"/> A | <input type="checkbox"/> B | <input type="checkbox"/> | <input type="checkbox"/> A | <input type="checkbox"/> B | <input type="checkbox"/> | <input type="checkbox"/> | --- |

For the tested points to EUT, please refer to attached page.

(Blue arrow mark for Air Discharge and red arrow mark for Contact Discharge)

| Discharge To Horizontal Coupling Plane | | | | | | | | | |
|--|-------------------------------------|-------------------------------------|--------------------------|--------------------------|-------------------------------------|--------------------------|---------------------------------------|----------------------------|-------------|
| Side of EUT | Test Levels | | | | Results | | | | |
| | ± 2 kV | ± 4 kV | ± 6 kV | ± 8 kV | Pass | Fail | Performance Criterion | | Observation |
| Front | <input checked="" type="checkbox"/> | <input checked="" type="checkbox"/> | <input type="checkbox"/> | <input type="checkbox"/> | <input checked="" type="checkbox"/> | <input type="checkbox"/> | <input checked="" type="checkbox"/> A | <input type="checkbox"/> B | --- |
| Back | <input checked="" type="checkbox"/> | <input checked="" type="checkbox"/> | <input type="checkbox"/> | <input type="checkbox"/> | <input checked="" type="checkbox"/> | <input type="checkbox"/> | <input checked="" type="checkbox"/> A | <input type="checkbox"/> B | --- |
| Left | <input checked="" type="checkbox"/> | <input checked="" type="checkbox"/> | <input type="checkbox"/> | <input type="checkbox"/> | <input checked="" type="checkbox"/> | <input type="checkbox"/> | <input checked="" type="checkbox"/> A | <input type="checkbox"/> B | --- |
| Right | <input checked="" type="checkbox"/> | <input checked="" type="checkbox"/> | <input type="checkbox"/> | <input type="checkbox"/> | <input checked="" type="checkbox"/> | <input type="checkbox"/> | <input checked="" type="checkbox"/> A | <input type="checkbox"/> B | --- |

| Discharge To Vertical Coupling Plane | | | | | | | | | |
|--------------------------------------|-------------------------------------|-------------------------------------|--------------------------|--------------------------|-------------------------------------|--------------------------|---------------------------------------|----------------------------|-------------|
| Side of EUT | Test Levels | | | | Results | | | | |
| | ± 2 kV | ± 4 kV | ± 6 kV | ± 8 kV | Pass | Fail | Performance Criterion | | Observation |
| Front | <input checked="" type="checkbox"/> | <input checked="" type="checkbox"/> | <input type="checkbox"/> | <input type="checkbox"/> | <input checked="" type="checkbox"/> | <input type="checkbox"/> | <input checked="" type="checkbox"/> A | <input type="checkbox"/> B | --- |
| Back | <input checked="" type="checkbox"/> | <input checked="" type="checkbox"/> | <input type="checkbox"/> | <input type="checkbox"/> | <input checked="" type="checkbox"/> | <input type="checkbox"/> | <input checked="" type="checkbox"/> A | <input type="checkbox"/> B | --- |
| Left | <input checked="" type="checkbox"/> | <input checked="" type="checkbox"/> | <input type="checkbox"/> | <input type="checkbox"/> | <input checked="" type="checkbox"/> | <input type="checkbox"/> | <input checked="" type="checkbox"/> A | <input type="checkbox"/> B | --- |
| Right | <input checked="" type="checkbox"/> | <input checked="" type="checkbox"/> | <input type="checkbox"/> | <input type="checkbox"/> | <input checked="" type="checkbox"/> | <input type="checkbox"/> | <input checked="" type="checkbox"/> A | <input type="checkbox"/> B | --- |

NOTE : There was no change compared with initial operation during the test.

| | | | |
|--------------|-------------------------|-----------|------|
| Product | Network Camera | | |
| Test Item | Electrostatic Discharge | | |
| Test Mode | Mode 2 | | |
| Date of Test | 07/27/2011 | Test Site | TE04 |

| Air Discharge | | | | | | | | | | | | |
|---------------|-------------------------------------|---------------------------------------|----------------------------|-------------------------------------|---------------------------------------|----------------------------|-------------------------------------|---------------------------------------|----------------------------|-------------------------------------|--------------------------|-------------|
| Test Points | Test Levels | | | | | | Results | | | | | |
| | ± 2 kV | Performance Criterion | | ± 4 kV | Performance Criterion | | ± 8 kV | Performance Criterion | | Pass | Fail | Observation |
| Front | <input checked="" type="checkbox"/> | <input checked="" type="checkbox"/> A | <input type="checkbox"/> B | <input checked="" type="checkbox"/> | <input checked="" type="checkbox"/> A | <input type="checkbox"/> B | <input checked="" type="checkbox"/> | <input checked="" type="checkbox"/> A | <input type="checkbox"/> B | <input checked="" type="checkbox"/> | <input type="checkbox"/> | --- |
| Back | <input checked="" type="checkbox"/> | <input checked="" type="checkbox"/> A | <input type="checkbox"/> B | <input checked="" type="checkbox"/> | <input checked="" type="checkbox"/> A | <input type="checkbox"/> B | <input checked="" type="checkbox"/> | <input checked="" type="checkbox"/> A | <input type="checkbox"/> B | <input checked="" type="checkbox"/> | <input type="checkbox"/> | --- |
| Left | <input type="checkbox"/> | <input type="checkbox"/> A | <input type="checkbox"/> B | <input type="checkbox"/> | <input type="checkbox"/> A | <input type="checkbox"/> B | <input type="checkbox"/> | <input type="checkbox"/> A | <input type="checkbox"/> B | <input type="checkbox"/> | <input type="checkbox"/> | --- |
| Right | <input type="checkbox"/> | <input type="checkbox"/> A | <input type="checkbox"/> B | <input type="checkbox"/> | <input type="checkbox"/> A | <input type="checkbox"/> B | <input type="checkbox"/> | <input type="checkbox"/> A | <input type="checkbox"/> B | <input type="checkbox"/> | <input type="checkbox"/> | --- |
| Top | <input type="checkbox"/> | <input type="checkbox"/> A | <input type="checkbox"/> B | <input type="checkbox"/> | <input type="checkbox"/> A | <input type="checkbox"/> B | <input type="checkbox"/> | <input type="checkbox"/> A | <input type="checkbox"/> B | <input type="checkbox"/> | <input type="checkbox"/> | --- |
| Bottom | <input type="checkbox"/> | <input type="checkbox"/> A | <input type="checkbox"/> B | <input type="checkbox"/> | <input type="checkbox"/> A | <input type="checkbox"/> B | <input type="checkbox"/> | <input type="checkbox"/> A | <input type="checkbox"/> B | <input type="checkbox"/> | <input type="checkbox"/> | --- |

| Contact Discharge | | | | | | | | | | | | |
|-------------------|-------------------------------------|---------------------------------------|----------------------------|-------------------------------------|---------------------------------------|----------------------------|--------------------------|----------------------------|----------------------------|-------------------------------------|--------------------------|-------------|
| Test Points | Test Levels | | | | | | Results | | | | | |
| | ± 2 kV | Performance Criterion | | ± 4 kV | Performance Criterion | | ± 8 kV | Performance Criterion | | Pass | Fail | Observation |
| Front | <input checked="" type="checkbox"/> | <input checked="" type="checkbox"/> A | <input type="checkbox"/> B | <input checked="" type="checkbox"/> | <input checked="" type="checkbox"/> A | <input type="checkbox"/> B | <input type="checkbox"/> | <input type="checkbox"/> A | <input type="checkbox"/> B | <input checked="" type="checkbox"/> | <input type="checkbox"/> | --- |
| Back | <input checked="" type="checkbox"/> | <input checked="" type="checkbox"/> A | <input type="checkbox"/> B | <input checked="" type="checkbox"/> | <input checked="" type="checkbox"/> A | <input type="checkbox"/> B | <input type="checkbox"/> | <input type="checkbox"/> A | <input type="checkbox"/> B | <input checked="" type="checkbox"/> | <input type="checkbox"/> | --- |
| Left | <input type="checkbox"/> | <input type="checkbox"/> A | <input type="checkbox"/> B | <input type="checkbox"/> | <input type="checkbox"/> A | <input type="checkbox"/> B | <input type="checkbox"/> | <input type="checkbox"/> A | <input type="checkbox"/> B | <input type="checkbox"/> | <input type="checkbox"/> | --- |
| Right | <input type="checkbox"/> | <input type="checkbox"/> A | <input type="checkbox"/> B | <input type="checkbox"/> | <input type="checkbox"/> A | <input type="checkbox"/> B | <input type="checkbox"/> | <input type="checkbox"/> A | <input type="checkbox"/> B | <input type="checkbox"/> | <input type="checkbox"/> | --- |
| Top | <input type="checkbox"/> | <input type="checkbox"/> A | <input type="checkbox"/> B | <input type="checkbox"/> | <input type="checkbox"/> A | <input type="checkbox"/> B | <input type="checkbox"/> | <input type="checkbox"/> A | <input type="checkbox"/> B | <input type="checkbox"/> | <input type="checkbox"/> | --- |
| Bottom | <input type="checkbox"/> | <input type="checkbox"/> A | <input type="checkbox"/> B | <input type="checkbox"/> | <input type="checkbox"/> A | <input type="checkbox"/> B | <input type="checkbox"/> | <input type="checkbox"/> A | <input type="checkbox"/> B | <input type="checkbox"/> | <input type="checkbox"/> | --- |

For the tested points to EUT, please refer to attached page.

(Blue arrow mark for Air Discharge and red arrow mark for Contact Discharge)

| Discharge To Horizontal Coupling Plane | | | | | | | | | |
|--|-------------------------------------|-------------------------------------|--------------------------|--------------------------|-------------------------------------|--------------------------|---------------------------------------|----------------------------|-------------|
| Side of EUT | Test Levels | | | | Results | | | | |
| | ± 2 kV | ± 4 kV | ± 6 kV | ± 8 kV | Pass | Fail | Performance Criterion | | Observation |
| Front | <input checked="" type="checkbox"/> | <input checked="" type="checkbox"/> | <input type="checkbox"/> | <input type="checkbox"/> | <input checked="" type="checkbox"/> | <input type="checkbox"/> | <input checked="" type="checkbox"/> A | <input type="checkbox"/> B | --- |
| Back | <input checked="" type="checkbox"/> | <input checked="" type="checkbox"/> | <input type="checkbox"/> | <input type="checkbox"/> | <input checked="" type="checkbox"/> | <input type="checkbox"/> | <input checked="" type="checkbox"/> A | <input type="checkbox"/> B | --- |
| Left | <input checked="" type="checkbox"/> | <input checked="" type="checkbox"/> | <input type="checkbox"/> | <input type="checkbox"/> | <input checked="" type="checkbox"/> | <input type="checkbox"/> | <input checked="" type="checkbox"/> A | <input type="checkbox"/> B | --- |
| Right | <input checked="" type="checkbox"/> | <input checked="" type="checkbox"/> | <input type="checkbox"/> | <input type="checkbox"/> | <input checked="" type="checkbox"/> | <input type="checkbox"/> | <input checked="" type="checkbox"/> A | <input type="checkbox"/> B | --- |

| Discharge To Vertical Coupling Plane | | | | | | | | | |
|--------------------------------------|-------------------------------------|-------------------------------------|--------------------------|--------------------------|-------------------------------------|--------------------------|---------------------------------------|----------------------------|-------------|
| Side of EUT | Test Levels | | | | Results | | | | |
| | ± 2 kV | ± 4 kV | ± 6 kV | ± 8 kV | Pass | Fail | Performance Criterion | | Observation |
| Front | <input checked="" type="checkbox"/> | <input checked="" type="checkbox"/> | <input type="checkbox"/> | <input type="checkbox"/> | <input checked="" type="checkbox"/> | <input type="checkbox"/> | <input checked="" type="checkbox"/> A | <input type="checkbox"/> B | --- |
| Back | <input checked="" type="checkbox"/> | <input checked="" type="checkbox"/> | <input type="checkbox"/> | <input type="checkbox"/> | <input checked="" type="checkbox"/> | <input type="checkbox"/> | <input checked="" type="checkbox"/> A | <input type="checkbox"/> B | --- |
| Left | <input checked="" type="checkbox"/> | <input checked="" type="checkbox"/> | <input type="checkbox"/> | <input type="checkbox"/> | <input checked="" type="checkbox"/> | <input type="checkbox"/> | <input checked="" type="checkbox"/> A | <input type="checkbox"/> B | --- |
| Right | <input checked="" type="checkbox"/> | <input checked="" type="checkbox"/> | <input type="checkbox"/> | <input type="checkbox"/> | <input checked="" type="checkbox"/> | <input type="checkbox"/> | <input checked="" type="checkbox"/> A | <input type="checkbox"/> B | --- |

NOTE : There was no change compared with initial operation during the test.

5.1.6. Test Photograph

Test Mode : Mode 1

Description : Front View of ESD Test



Test Mode : Mode 1

Description : Close View of ESD Test



Test Mode : Mode 1

Description : Close View of ESD Test



Test Mode : Mode 1

Description : Close View of ESD Test



Test Mode : Mode 1

Description : Close View of ESD Test



Test Mode : Mode 2

Description : Front View of ESD Test



Test Mode : Mode 2

Description : Close View of ESD Test



Test Mode : Mode 2

Description : Close View of ESD Test



Test Mode : Mode 2

Description : Close View of ESD Test



Test Mode : Mode 2

Description : Close View of ESD Test



5.2. Radiated Electromagnetic Field (RS)

5.2.1. Test Specification

| IEC 61000-4-3 | | | |
|--------------------------|------------------------|--------------------|-----------------------|
| Environmental Phenomena | Units | Test Specification | Performance Criterion |
| Enclosure Port | | | |
| Test Frequency Range | MHz | 80-1000 | A |
| RF Electromagnetic Field | V/m(Un-modulated, rms) | 3 | |
| Amplitude Modulated | % AM (1kHz) | 80 | |

EUT tested in accordance with the specifications given by the standard of IEC 61000-4-3.

Step : 1%

Step time : 3 Second

5.2.2. Test Instrument

| Equipment | Manufacturer | Model Number | Serial Number | Cal. Date | Remark |
|-----------------------------|-----------------------------|-----------------------|----------------|------------|--------|
| SMB 100A SIGNAL GENERATOR | R&S | SMB100A | 100724 | 02/23/2011 | (1) |
| NRP-Z91 POWER SENSOR | R&S | NRP-Z91 | 100611 | 07/06/2011 | (1) |
| NRP-Z91 POWER SENSOR | R&S | NRP-Z91 | 100612 | 07/07/2011 | (1) |
| NRP POWER METER | R&S | NRP | 101591 | 07/07/2011 | (1) |
| Solid State Power Amplifier | BONN ELEKTRONIK | BLWA 0830-160/100/40D | 87050 | N.C.R. | ----- |
| Signal Generator Module | R&S | SM300 Module | 102209 | N.C.R. | ----- |
| Broad-Band Horn Antenna | Schwarzbeck Mess-Elektronik | BBHA 9120 | BBHA 9120 E388 | N.C.R. | ----- |
| Log-periodic Antenna | R&S | HL046 | 100046 | N.C.R. | ----- |
| Test Site | ATL | TE07 | 888009 | N.C.R. | ----- |

Remark: ⁽¹⁾ Calibration period 1 year. ⁽²⁾ Calibration period 2 years.

NOTE: N.C.R. = No Calibration Request.

5.2.3. Setup

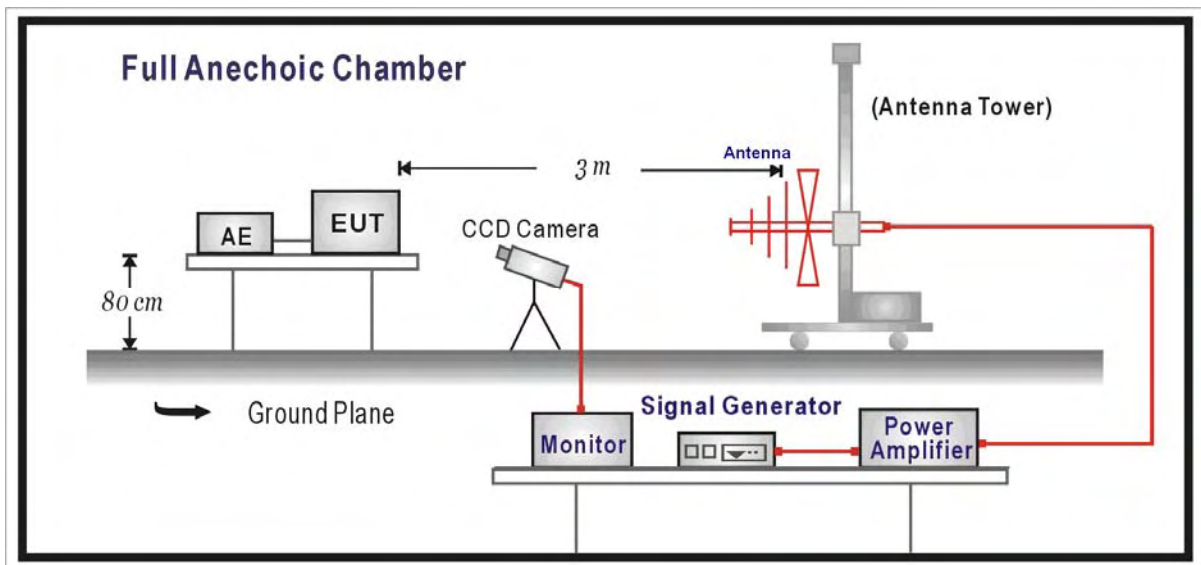

5.2.4. Test Procedure

The test procedure was in accordance with IEC 61000-4-3

- a) The testing was performed in a fully anechoic chamber. The transmit antenna was located at a distance of 3 meters from the EUT.
- b) The frequency range is swept from 80 MHz to 1000 MHz, with the signal 80% amplitude modulated with a 1kHz sine-wave. The rate of sweep did not exceed 1.5×10^{-3} decade/s, where the frequency range is swept incrementally, the step size was 1% of preceding frequency value.
- c) The dwell time at each frequency shall be not less than the time necessary for the EUT to be able to respond.
- d) The test was performed with the EUT exposed to both vertically and horizontally polarized fields on each of the four sides.

5.2.5. Test Result

| | | | |
|--------------|-------------------------|-----------|------|
| Product | Network Camera | | |
| Test Item | Radiated Susceptibility | | |
| Test Mode | Mode 1 | | |
| Date of Test | 07/26/2011 | Test Site | TE07 |

| Frequency (MHz) | Polarity | Azimuth | Field Strength (V/m) | Performance Criterion | Result |
|-----------------|----------|---------|----------------------|--|--------|
| 80 ~ 1000 | H | 0 | 3 | <input checked="" type="checkbox"/> A <input type="checkbox"/> B | PASS |
| 80 ~ 1000 | V | 0 | 3 | <input checked="" type="checkbox"/> A <input type="checkbox"/> B | PASS |
| 80 ~ 1000 | H | 90 | 3 | <input checked="" type="checkbox"/> A <input type="checkbox"/> B | PASS |
| 80 ~ 1000 | V | 90 | 3 | <input checked="" type="checkbox"/> A <input type="checkbox"/> B | PASS |
| 80 ~ 1000 | H | 180 | 3 | <input checked="" type="checkbox"/> A <input type="checkbox"/> B | PASS |
| 80 ~ 1000 | V | 180 | 3 | <input checked="" type="checkbox"/> A <input type="checkbox"/> B | PASS |
| 80 ~ 1000 | H | 270 | 3 | <input checked="" type="checkbox"/> A <input type="checkbox"/> B | PASS |
| 80 ~ 1000 | V | 270 | 3 | <input checked="" type="checkbox"/> A <input type="checkbox"/> B | PASS |

Note:

The testing performed is from lowest level up to the highest level as required by standard, but only highest level is shown on the report.

Criterion A: Operate as intended during and after the test

Criterion B: Operate as intended after the test

Criterion C: Loss/Error of function

Additional Information

There was no observable degradation in performance.

EUT stopped operation and could / could not be reset by operator at _____ V/m at frequency _____ MHz.

No false alarms or other malfunctions were observed during or after the test.

| | | | |
|--------------|-------------------------|-----------|------|
| Product | Network Camera | | |
| Test Item | Radiated Susceptibility | | |
| Test Mode | Mode 2 | | |
| Date of Test | 07/26/2011 | Test Site | TE07 |

| Frequency (MHz) | Polarity | Azimuth | Field Strength (V/m) | Performance Criterion | Result |
|-----------------|----------|---------|----------------------|--|--------|
| 80 ~ 1000 | H | 0 | 3 | <input checked="" type="checkbox"/> A <input type="checkbox"/> B | PASS |
| 80 ~ 1000 | V | 0 | 3 | <input checked="" type="checkbox"/> A <input type="checkbox"/> B | PASS |
| 80 ~ 1000 | H | 90 | 3 | <input checked="" type="checkbox"/> A <input type="checkbox"/> B | PASS |
| 80 ~ 1000 | V | 90 | 3 | <input checked="" type="checkbox"/> A <input type="checkbox"/> B | PASS |
| 80 ~ 1000 | H | 180 | 3 | <input checked="" type="checkbox"/> A <input type="checkbox"/> B | PASS |
| 80 ~ 1000 | V | 180 | 3 | <input checked="" type="checkbox"/> A <input type="checkbox"/> B | PASS |
| 80 ~ 1000 | H | 270 | 3 | <input checked="" type="checkbox"/> A <input type="checkbox"/> B | PASS |
| 80 ~ 1000 | V | 270 | 3 | <input checked="" type="checkbox"/> A <input type="checkbox"/> B | PASS |

Note:

The testing performed is from lowest level up to the highest level as required by standard, but only highest level is shown on the report.

Criterion A: Operate as intended during and after the test

Criterion B: Operate as intended after the test

Criterion C: Loss/Error of function

Additional Information

There was no observable degradation in performance.

EUT stopped operation and could / could not be reset by operator at _____ V/m at frequency _____ MHz.

No false alarms or other malfunctions were observed during or after the test.

5.2.6. Test Photograph

Test Mode : Mode 1

Description : Front View of RS Test



Test Mode : Mode 2

Description : Front View of RS Test



5.3. Electrical Fast Transient/Burst (EFT)

5.3.1. Test Specification

| IEC 61000-4-4 | | | | |
|-----------------------------|-------------------------|---|--------------------|-----------------------|
| Item | Environmental Phenomena | Units | Test Specification | Performance Criterion |
| I/O and communication ports | | | | |
| Fast Transients Common Mode | | kV (Peak) Tr/Th ns Rep. Frequency kHz | +0.5 5/50 5 | B |
| Input DC Power Ports | | | | |
| Fast Transients Common Mode | | kV (Peak) Tr/Th ns Rep. Frequency kHz | +0.5 5/50 5 | B |
| Input AC Power Ports | | | | |
| Fast Transients Common Mode | | kV (Peak) Tr/Th ns Rep. Frequency kHz | +1 5/50 5 | B |

5.3.2. Test Instrument

| Equipment | Manufacturer | Model Number | Serial Number | Cal. Date | Remark |
|---------------------|----------------|-------------------|---------------|------------|--------|
| EMC Immunity Tester | EMC-PARTNER AG | TRANSIENT 2000IN6 | 952 | 02/08/2011 | (1) |
| Test Site | ATL | TE08 | TE08 | N.C.R. | ---- |

Remark: (1) Calibration period 1 year. (2) Calibration period 2 years.

NOTE: N.C.R. = No Calibration Request.

5.3.3. Setup

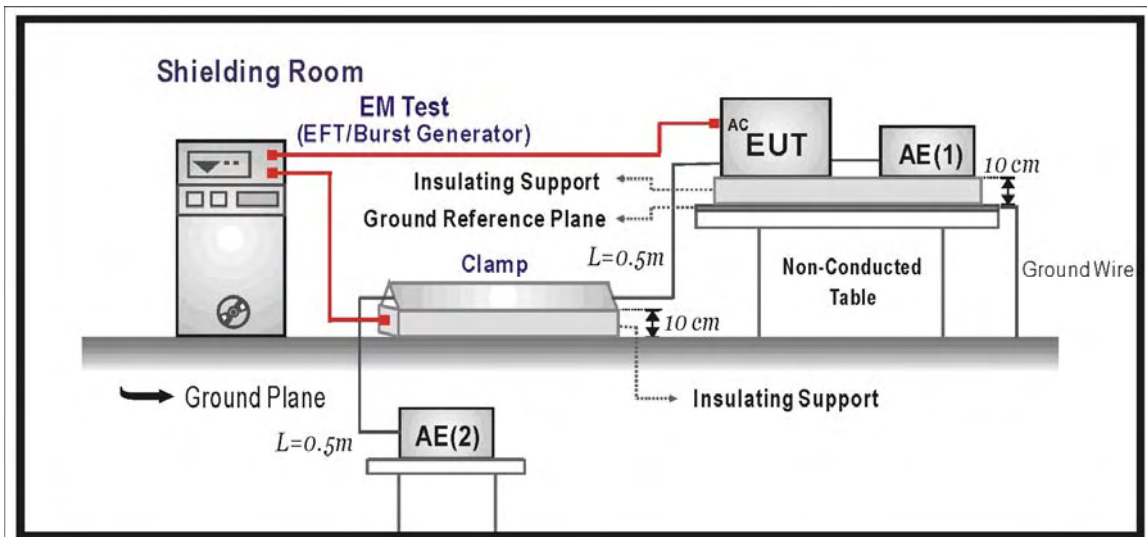

5.3.4. Test Procedure

- a) Both positive and negative polarity discharges were applied.
- b) The length of the “hot wire” from the coaxial output of the EFT generator to the terminals on the EUT should not exceed 1 meter.
- c) The duration time of each test sequential was 1 minute.
- d) The transient/burst waveform was in accordance with IEC 61000-4-4, 5/50ns.

5.3.5. Test Result

| | | | |
|--------------|---------------------------------|-----------|------|
| Product | Network Camera | | |
| Test Item | Electrical Fast Transient/Burst | | |
| Test Mode | Mode 1 | | |
| Date of Test | 07/26/2011 | Test Site | TE08 |

| Test Point | Polarity | Test Level (kV) | Inject Time (Second) | Inject Method | Performance Criterion | Result |
|------------|----------|-----------------|----------------------|---------------|--|--------|
| L | ± | 1 | 60 | Direct | <input checked="" type="checkbox"/> A <input type="checkbox"/> B | PASS |
| N | ± | 1 | 60 | Direct | <input checked="" type="checkbox"/> A <input type="checkbox"/> B | PASS |
| L+N | ± | 1 | 60 | Direct | <input checked="" type="checkbox"/> A <input type="checkbox"/> B | PASS |
| LAN Port | ± | 0.5 | 60 | Direct | <input checked="" type="checkbox"/> A <input type="checkbox"/> B | PASS |

Note:

The testing performed is from lowest level up to the highest level as required by standard, but only highest level is shown on the report.

Criterion A : Operate as intended during and after the test

Criterion B : Operate as intended after the test

Criterion C : Loss/Error of function

Additional Information

EUT stopped operation and could be reset by itself at _____ kV of Line.

No false alarms or other malfunctions were observed during or after the test.

| | | | |
|--------------|---------------------------------|-----------|------|
| Product | Network Camera | | |
| Test Item | Electrical Fast Transient/Burst | | |
| Test Mode | Mode 2 | | |
| Date of Test | 07/26/2011 | Test Site | TE08 |

| Test Point | Polarity | Test Level (kV) | Inject Time (Second) | Inject Method | Performance Criterion | Result |
|------------|----------|-----------------|----------------------|---------------|--|--------|
| LAN Port | ± | 0.5 | 60 | Direct | <input checked="" type="checkbox"/> A <input type="checkbox"/> B | PASS |

Note:

The testing performed is from lowest level up to the highest level as required by standard, but only highest level is shown on the report.

Criterion A : Operate as intended during and after the test

Criterion B : Operate as intended after the test

Criterion C : Loss/Error of function

Additional Information

EUT stopped operation and could be reset by itself at _____ kV of Line.

No false alarms or other malfunctions were observed during or after the test.

5.3.6. Test Photograph

Test Mode : Mode 1

Description : Front View of EFT Test – AC Mains, LAN Port



Test Mode : Mode 2

Description : Front View of EFT Test –LAN Port



5.4. Surge

5.4.1. Test Specification

| IEC61000-4-5 | | | | |
|--|-------------------------|----------------------|-----------------------------|-----------------------|
| Item | Environmental Phenomena | Units | Test Specification | Performance Criterion |
| Signal Ports and Telecommunication Ports(See 1) and 2)) | | | | |
| Surges Line to Ground | | Tr/Th us kV | 1.2/50 (8/20) ± 1 | B |
| Input DC Power Ports | | | | |
| Surges Line to Ground | | Tr/Th us kV | 1.2/50 (8/20) ± 0.5 | B |
| Input AC Power Ports | | | | |
| Surges Line to Line Line to Ground | | Tr/Th us kV kV | 1.2/50 (8/20) ± 1 ± 2 | B |

5.4.2. Test Instrument

| Equipment | Manufacturer | Model Number | Serial Number | Cal. Date | Remark |
|---------------------|----------------|-------------------|---------------|------------|--------|
| EMC Immunity Tester | EMC-PARTNER AG | TRANSIENT 2000IN6 | 952 | 02/08/2011 | (1) |
| Test Site | ATL | TE08 | TE08 | N.C.R. | ----- |

Remark: (1) Calibration period 1 year. (2) Calibration period 2 years.

NOTE: N.C.R. = No Calibration Request.

5.4.3. Setup

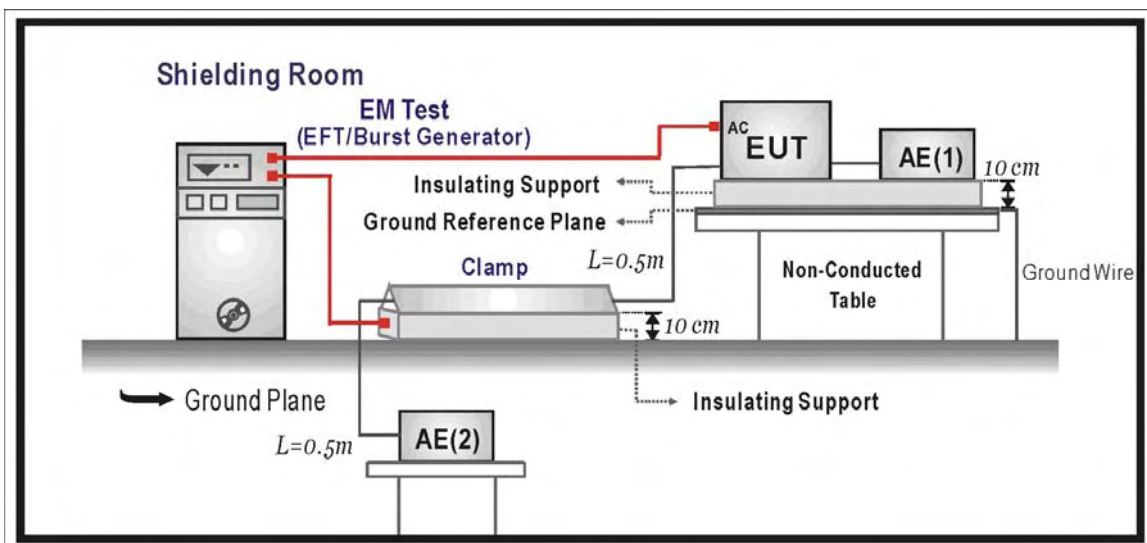

5.4.4. Test Procedure

- a) For EUT power supply:

The surge is applied to the EUT power supply terminals via the capacitive coupling network. Decoupling networks are required in order to avoid possible adverse effects on equipment not under test that may be powered by the same lines, and to provide sufficient decoupling impedance to the surge wave. The power cord between the EUT and the coupling/decoupling networks was shorter than 2 meters in length.

- b) For test applied to unshielded un-symmetrically operated interconnection lines of EUT:

The surge was applied to the lines via the capacitive coupling. The coupling / decoupling networks didn't influence the specified functional conditions of the EUT. The interconnection line between the EUT and the coupling/decoupling networks was shorter than 2 meters in length.

- c) For test applied to unshielded symmetrically operated interconnection / telecommunication lines of EUT:

The surge was applied to the lines via gas arrestors coupling. Test levels below the ignition point of the coupling arrestor were not specified. The interconnection line between the EUT and the coupling/decoupling networks was shorter than 2 meters in length.

5.4.5. Test Result

| | | | |
|--------------|----------------|-----------|------|
| Product | Network Camera | | |
| Test Item | Surge | | |
| Test Mode | Mode 1 | | |
| Date of Test | 07/27/2011 | Test Site | TE08 |

| Inject Line | Polarity | Angle | Voltage kV | Time Interval (Second) | Inject Method | Performance Criterion | Result |
|-------------|----------|-------|------------|------------------------|---------------|--|--------|
| L+N | ± | 0 | 1kV | 60 | Direct | <input checked="" type="checkbox"/> A <input type="checkbox"/> B | Pass |
| L+N | ± | 90 | 1kV | 60 | Direct | <input checked="" type="checkbox"/> A <input type="checkbox"/> B | Pass |
| L+N | ± | 180 | 1kV | 60 | Direct | <input checked="" type="checkbox"/> A <input type="checkbox"/> B | Pass |
| L+N | ± | 270 | 1kV | 60 | Direct | <input checked="" type="checkbox"/> A <input type="checkbox"/> B | Pass |
| L+PE | ± | 0 | 2kV | 60 | Direct | <input checked="" type="checkbox"/> A <input type="checkbox"/> B | Pass |
| L+PE | ± | 90 | 2kV | 60 | Direct | <input checked="" type="checkbox"/> A <input type="checkbox"/> B | Pass |
| L+PE | ± | 180 | 2kV | 60 | Direct | <input checked="" type="checkbox"/> A <input type="checkbox"/> B | Pass |
| L+PE | ± | 270 | 2kV | 60 | Direct | <input checked="" type="checkbox"/> A <input type="checkbox"/> B | Pass |
| N+PE | ± | 0 | 2kV | 60 | Direct | <input checked="" type="checkbox"/> A <input type="checkbox"/> B | Pass |
| N+PE | ± | 90 | 2kV | 60 | Direct | <input checked="" type="checkbox"/> A <input type="checkbox"/> B | Pass |
| N+PE | ± | 180 | 2kV | 60 | Direct | <input checked="" type="checkbox"/> A <input type="checkbox"/> B | Pass |
| N+PE | ± | 270 | 2kV | 60 | Direct | <input checked="" type="checkbox"/> A <input type="checkbox"/> B | Pass |
| L+N+PE | ± | 0 | 2kV | 60 | Direct | <input checked="" type="checkbox"/> A <input type="checkbox"/> B | Pass |
| L+N+PE | ± | 90 | 2kV | 60 | Direct | <input checked="" type="checkbox"/> A <input type="checkbox"/> B | Pass |
| L+N+PE | ± | 180 | 2kV | 60 | Direct | <input checked="" type="checkbox"/> A <input type="checkbox"/> B | Pass |
| L+N+PE | ± | 270 | 2kV | 60 | Direct | <input checked="" type="checkbox"/> A <input type="checkbox"/> B | Pass |

Note:

The testing performed is from lowest level up to the highest level as required by standard, but only highest level is shown on the report.

Criterion A : Operate as intended during and after the test

Criterion B : Operate as intended after the test

Criterion C : Loss/Error of function

Additional Information

EUT stopped operation and could / could not be reset by operator at _____kV of Line _____.

No false alarms or other malfunctions were observed during or after the test.

5.4.6. Test Photograph

Test Mode : Mode 1

Description : Front View of Surge Test – AC Mains



5.5. Conducted Susceptibility (CS)

5.5.1. Test Specification

| IEC 61000-4-6 | | | |
|--|-----------------------|--------------------|-----------------------|
| Environmental Phenomena | Units | Test Specification | Performance Criterion |
| Signal Ports and Telecommunication Ports | | | |
| Radio-Frequency Continuous Conducted | MHz | 0.15-80 | A |
| | V (rms, Un-modulated) | 3 | |
| | % AM (1kHz) | 80 | |
| Input DC Power Ports | | | |
| Radio-Frequency Continuous Conducted | MHz | 0.15-80 | A |
| | V (rms, Un-modulated) | 3 | |
| | % AM (1kHz) | 80 | |
| Input AC Power Ports | | | |
| Radio-Frequency Continuous Conducted | MHz | 0.15-80 | A |
| | V (rms, Un-modulated) | 3 | |
| | % AM (1kHz) | 80 | |

EUT tested in accordance with the specifications given by the standard of IEC 61000-4-6.

Step : 1%

Step time : 3 Second

5.5.2. Test Instrument

| Equipment | Manufacturer | Model Number | Serial Number | Cal. Date | Remark |
|--|--------------|---------------------------|---------------|------------|--------|
| Signal Line Coupling Decoupling Network | FCC | FCC-801--T2-RJ11 | 8017 | 07/07/2011 | (1) |
| Signal Line Coupling Decoupling Network | FCC | FCC-801--T4-RJ45 | 8018 | 07/07/2011 | (1) |
| Signal Line Coupling Decoupling Network | FCC | FCC-801-M2/M3-1 6A8030 | 8030 | 07/07/2011 | (1) |
| EM Injection Clamp | FCC | F-203I-23MM | 8576 | 07/07/2011 | (1) |
| Amplifiers | ar | 75A250A | 328729 | 07/07/2011 | (1) |
| NRP-Z91 POWER SENSOR | R&S | NRP-Z91 | 100613 | 07/07/2011 | (1) |
| De-coupling Network | FCC | F-203I-23MM- DCN | 8234 | N.C.R. | ---- |
| Test Site | ATL | TE08 | TE08 | N.C.R. | ---- |

Remark: ⁽¹⁾ Calibration period 1 year. ⁽²⁾ Calibration period 2 years.

NOTE: N.C.R. = No Calibration Request.

5.5.3. Setup

CDN Method

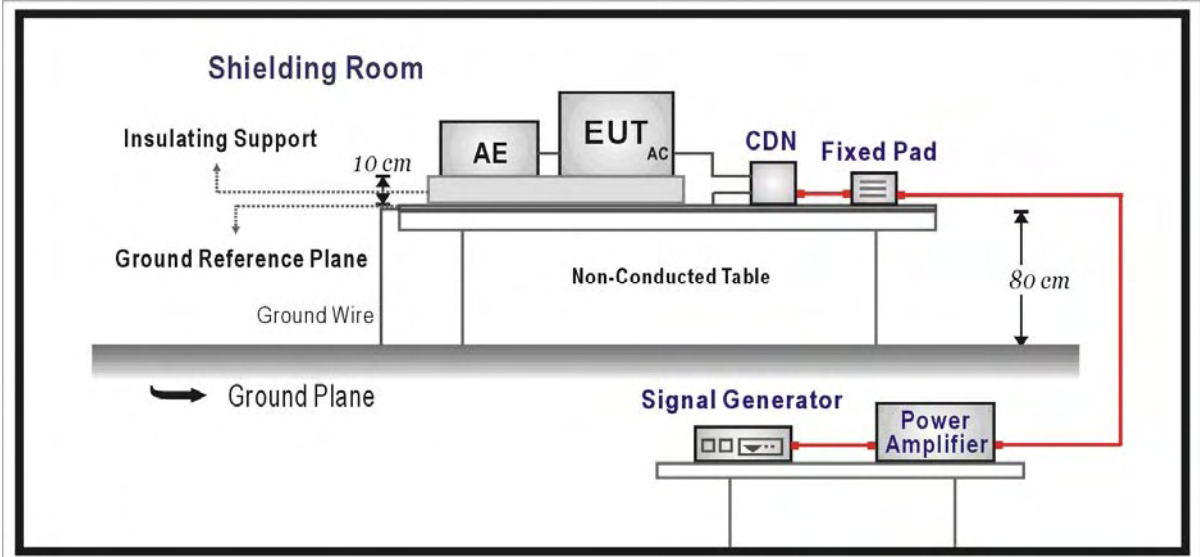

EM Clamp Method

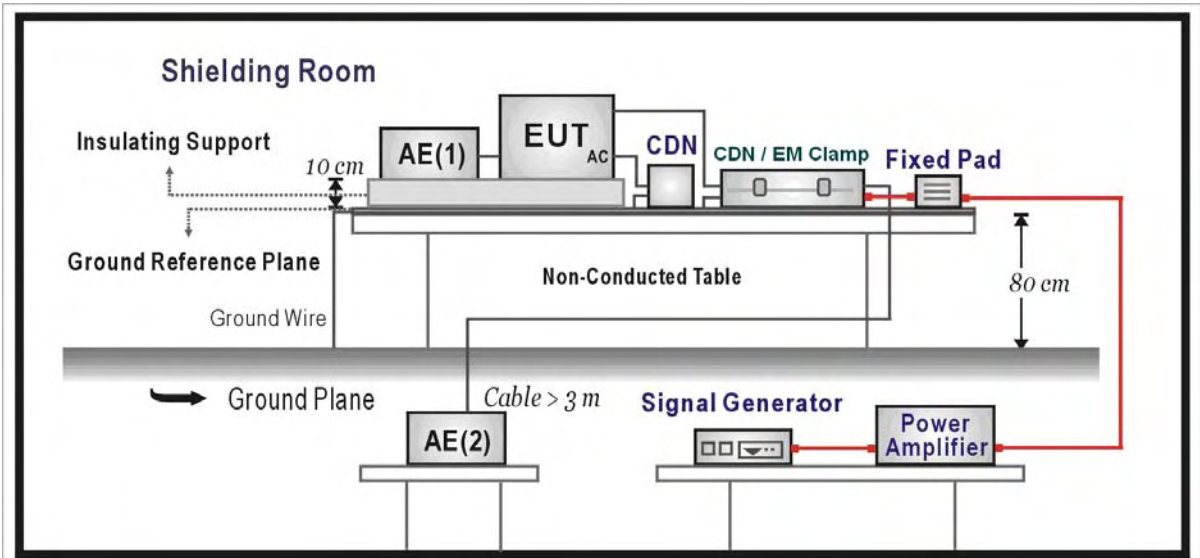

5.5.4. Test Procedure

The EUT shall be tested within its intended operating and climatic conditions.

The test shall be performed with the test generator connected to each of the coupling and decoupling devices in turn, while the other non-excited RF input ports of the coupling devices are terminated by a 50-ohm load resistor.

The frequency range was swept from 150 kHz to 80 MHz, using the signal level established during the setting process and with a disturbance signal of 80 % amplitude. The signal was modulated with a 1 kHz sine wave, pausing to adjust the RF signal level or the switch coupling devices as necessary. The sweep rate was 1.5×10^{-3} decades/s. Where the frequency range is swept incrementally, the step size was 1 % of preceding frequency value from 150 kHz to 80 MHz.

The dwell time at each frequency was less than the time necessary for the EUT to be exercised, and able to respond. Sensitive frequencies such as clock frequency and harmonics or frequencies of dominant interest, was analyzed separately.

Attempts were made to fully exercise the EUT during testing, and to fully interrogate all exercise modes selected for susceptibility.

5.5.5. Test Result

| | | | |
|--------------|--------------------------|-----------|------|
| Product | Network Camera | | |
| Test Item | Conducted Susceptibility | | |
| Test Mode | Mode 1 | | |
| Date of Test | 07/26/2011 | Test Site | TE08 |

| Frequency Band (MHz) | Field Strength (Vrms) | Inject Port | Inject Method | Performance Criterion | Result |
|----------------------|-----------------------|-------------|---------------|--|--------|
| 0.15 ~ 80 | 3 | AC Mains | CDN-M2 | <input checked="" type="checkbox"/> A <input type="checkbox"/> B | PASS |
| 0.15 ~ 80 | 3 | LAN Port | Clamp | <input checked="" type="checkbox"/> A <input type="checkbox"/> B | PASS |

Note:

The testing performed is from lowest level up to the highest level as required by standard, but only highest level is shown on the report.

Criterion A : Operate as intended during and after the test

Criterion B : Operate as intended after the test

Criterion C : Loss/Error of function

Additional Information

EUT stopped operation and could / could not be reset by operator at ____ dBuV (V) at frequency ____ MHz.

No false alarms or other malfunctions were observed during or after the test.

The acceptance criteria were met, and the EUT passed the test.

| | | | |
|--------------|--------------------------|-----------|------|
| Product | Network Camera | | |
| Test Item | Conducted Susceptibility | | |
| Test Mode | Mode 2 | | |
| Date of Test | 07/26/2011 | Test Site | TE08 |

| Frequency Band (MHz) | Field Strength (Vrms) | Inject Port | Inject Method | Performance Criterion | Result |
|----------------------|-----------------------|-------------|---------------|--|--------|
| 0.15 ~ 80 | 3 | LAN Port | Clamp | <input checked="" type="checkbox"/> A <input type="checkbox"/> B | PASS |

Note:

The testing performed is from lowest level up to the highest level as required by standard, but only highest level is shown on the report.

Criterion A : Operate as intended during and after the test

Criterion B : Operate as intended after the test

Criterion C : Loss/Error of function

Additional Information

EUT stopped operation and could / could not be reset by operator at _____ dBuV (V) at frequency _____MHz.

No false alarms or other malfunctions were observed during or after the test.

The acceptance criteria were met, and the EUT passed the test.

5.5.6. Test Photograph

Test Mode : Mode 1

Description : Front View of CS Test – AC Mains, LAN Port



Test Mode : Mode 2

Description : Front View of CS Test – LAN Port

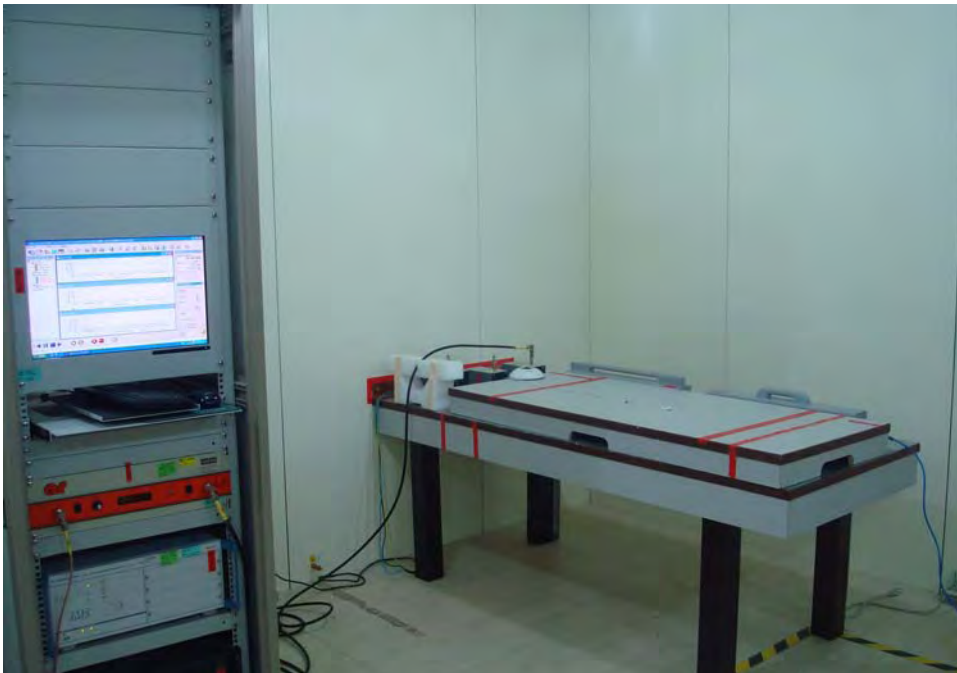

5.6. Power Frequency Magnetic Field (PMF)

5.6.1. Test Specification

| IEC 61000-4-8 | | | | |
|----------------|--------------------------------|--------------------|--------------------|-----------------------|
| Item | Environmental Phenomena | Units | Test Specification | Performance Criterion |
| Enclosure Port | | | | |
| | Power-Frequency Magnetic Field | Hz A/m (r.m.s.) | 50 1 | A |

EUT tested in accordance with the specifications given by the standard of IEC 61000-4-8.

Orientation : X, Y, Z

Test time : 180 Second

5.6.2. Test Instrument

| Equipment | Manufacturer | Model Number | Serial Number | Cal. Date | Remark |
|---------------------|----------------|-------------------|---------------|------------|--------|
| EMC Immunity Tester | EMC-PARTNER AG | TRANSIENT 2000IN6 | 952 | 02/08/2011 | (1) |
| Test Site | ATL | TE08 | TE08 | N.C.R. | ----- |

Remark: ⁽¹⁾ Calibration period 1 year. ⁽²⁾ Calibration period 2 years.

NOTE: N.C.R. = No Calibration Request.

5.6.3. Setup

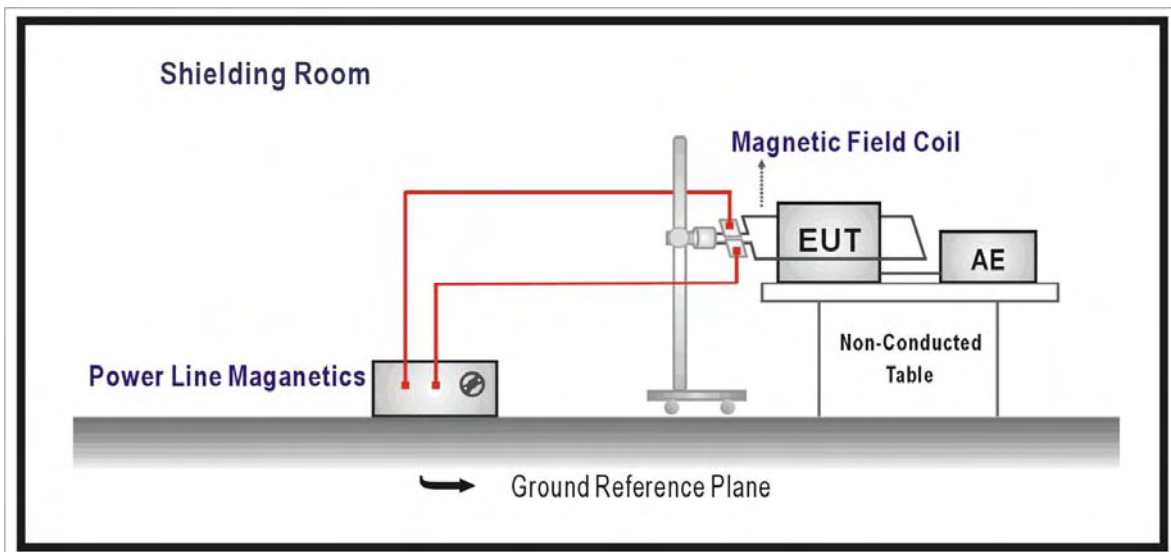

5.6.4. Test Procedure

- a). The equipment was configured and connected to satisfy its functional requirements. It shall be placed on the GRP with the interposition of a 0.1m-thick insulating support.
- b). The equipment cabinets shall be connected to the safety earth directly on the GRP via the earth terminal of the EUT.
- c). The power supply, input and output circuits shall be connected to the sources of power supply, control and signal.
- d). The cables supplied or recommended by the equipment manufacturer shall be used. 1 meter of all cables used shall be exposed to the magnetic field.

5.6.5. Test Result

| | | | |
|--------------|--------------------------------|-----------|------|
| Product | Network Camera | | |
| Test Item | Power Frequency Magnetic Field | | |
| Test Mode | Mode 1 | | |
| Date of Test | 07/26/2011 | Test Site | TE08 |

| Polarization | Frequency (Hz) | Magnetic Strength (A/m) | Performance Criterion | Result |
|---------------|----------------|-------------------------|--|--------|
| X Orientation | 50 | 1 | <input checked="" type="checkbox"/> A <input type="checkbox"/> B | PASS |
| Y Orientation | 50 | 1 | <input checked="" type="checkbox"/> A <input type="checkbox"/> B | PASS |
| Z Orientation | 50 | 1 | <input checked="" type="checkbox"/> A <input type="checkbox"/> B | PASS |

Note:

Criterion A : Operate as intended during and after the test

Criterion B : Operate as intended after the test

Criterion C : Loss/Error of function

Additional Information

EUT stopped operation and could / could not be reset by operator at _____ dBuV (V) at frequency _____ MHz.

No false alarms or other malfunctions were observed during or after the test.

The acceptance criteria were met, and the EUT passed the test.

| | | | |
|--------------|--------------------------------|-----------|------|
| Product | Network Camera | | |
| Test Item | Power Frequency Magnetic Field | | |
| Test Mode | Mode 2 | | |
| Date of Test | 07/26/2011 | Test Site | TE08 |

| Polarization | Frequency (Hz) | Magnetic Strength (A/m) | Performance Criterion | Result |
|---------------|----------------|-------------------------|--|--------|
| X Orientation | 50 | 1 | <input checked="" type="checkbox"/> A <input type="checkbox"/> B | PASS |
| Y Orientation | 50 | 1 | <input checked="" type="checkbox"/> A <input type="checkbox"/> B | PASS |
| Z Orientation | 50 | 1 | <input checked="" type="checkbox"/> A <input type="checkbox"/> B | PASS |

Note:

Criterion A : Operate as intended during and after the test

Criterion B : Operate as intended after the test

Criterion C : Loss/Error of function

Additional Information

EUT stopped operation and could / could not be reset by operator at _____ dBuV (V) at frequency _____ MHz.

No false alarms or other malfunctions were observed during or after the test.

The acceptance criteria were met, and the EUT passed the test.

5.6.6. Test Photograph

Test Mode : Mode 1

Description : Front View of PMF Test



Test Mode : Mode 2

Description : Front View of PMF Test



5.7. Voltage Dips and Interruption

5.7.1. Test Specification

| IEC 61000-4-11 | | | |
|-------------------------|-------|--------------------|-----------------------|
| Environmental Phenomena | Units | Test Specification | Performance Criterion |
| Input AC Power Ports | | | |
| Voltage Dips | 0 | % Reduction | B |
| | 0.5 | Period | |
| | 70 | % Reduction | C |
| | 25 | Period | |
| Voltage Interruptions | 0 | % Reduction | C |
| | 250 | Period | |

5.7.2. Test Instrument

| Equipment | Manufacturer | Model Number | Serial Number | Cal. Date | Remark |
|---------------------|----------------|-------------------|---------------|------------|--------|
| EMC Immunity Tester | EMC-PARTNER AG | TRANSIENT 2000IN6 | 952 | 02/08/2011 | (1) |
| Test Site | ATL | TE08 | TE08 | N.C.R. | ----- |

Remark: ⁽¹⁾ Calibration period 1 year. ⁽²⁾ Calibration period 2 years.

NOTE: N.C.R. = No Calibration Request.

5.7.3. Setup

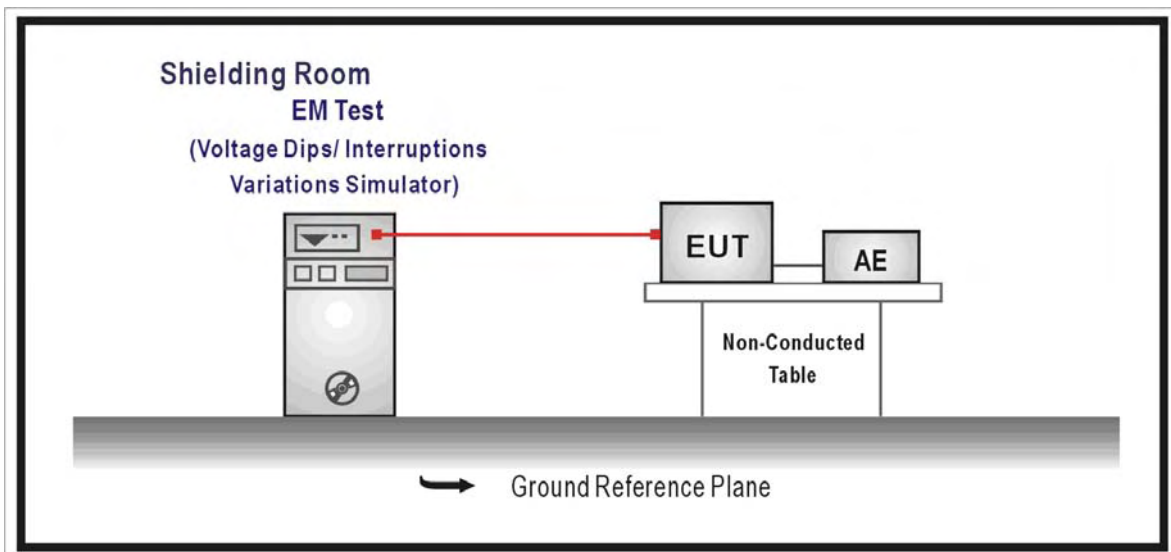

5.7.4. Test Procedure

The EUT and its load are placed on a table which is 0.8 meter above a metal ground plane measured 1m*1m min. And 0.65mm thick min. And projected beyond the EUT by at least 0.1m on all sides. The power cord shall be used the shortest power cord as specified by the manufacturer.

For Voltage Dips/ Interruptions test:

The selection of test voltage is based on the rated power range. If the operation range is large than 20% of lower power range, both end of specified voltage shall be tested. Otherwise, the typical voltage specification is selected as test voltage.

The EUT is connected to the power mains through a coupling device that directly couples to the Voltage Dips and Interruption Generator.

The EUT shall be tested for 30% voltage dip of supplied voltage and duration 25 Periods, for 95% voltage dip of supplied voltage and duration 0.5 Periods with a sequence of three voltage dips with intervals of 10 seconds, and for 95% voltage interruption of supplied voltage and duration 250 Periods with a sequence of three voltage interruptions with intervals of 10 seconds.

Voltage phase shifting are shall occur at 0° , 45° , 90° , 135° , 180° , 225° , 270° , 315° of the voltage.

5.7.5. Test Result

| | | | |
|--------------|---|-----------|------|
| Product | Network Camera | | |
| Test Item | Voltage Dips and Interruption Measurement | | |
| Test Mode | Mode 1 | | |
| Date of Test | 07/27/2011 | Test Site | TE08 |

| Voltage Reduction (%) | Angle | Test Duration (ms) | Performance Criterion | Test Result | Observation |
|-----------------------|-------|--------------------|---|-------------|-------------|
| >95(0V) | 0 | 10 | <input checked="" type="checkbox"/> A <input type="checkbox"/> B <input type="checkbox"/> C | Pass | Note 1 |
| >95(0V) | 45 | 10 | <input checked="" type="checkbox"/> A <input type="checkbox"/> B <input type="checkbox"/> C | Pass | Note 1 |
| >95(0V) | 90 | 10 | <input checked="" type="checkbox"/> A <input type="checkbox"/> B <input type="checkbox"/> C | Pass | Note 1 |
| >95(0V) | 135 | 10 | <input checked="" type="checkbox"/> A <input type="checkbox"/> B <input type="checkbox"/> C | Pass | Note 1 |
| >95(0V) | 180 | 10 | <input checked="" type="checkbox"/> A <input type="checkbox"/> B <input type="checkbox"/> C | Pass | Note 1 |
| >95(0V) | 225 | 10 | <input checked="" type="checkbox"/> A <input type="checkbox"/> B <input type="checkbox"/> C | Pass | Note 1 |
| >95(0V) | 270 | 10 | <input checked="" type="checkbox"/> A <input type="checkbox"/> B <input type="checkbox"/> C | Pass | Note 1 |
| >95(0V) | 315 | 10 | <input checked="" type="checkbox"/> A <input type="checkbox"/> B <input type="checkbox"/> C | Pass | Note 1 |
| 30(161V) | 0 | 500 | <input checked="" type="checkbox"/> A <input type="checkbox"/> B <input type="checkbox"/> C | Pass | Note 1 |
| 30(161V) | 45 | 500 | <input checked="" type="checkbox"/> A <input type="checkbox"/> B <input type="checkbox"/> C | Pass | Note 1 |
| 30(161V) | 90 | 500 | <input checked="" type="checkbox"/> A <input type="checkbox"/> B <input type="checkbox"/> C | Pass | Note 1 |
| 30(161V) | 135 | 500 | <input checked="" type="checkbox"/> A <input type="checkbox"/> B <input type="checkbox"/> C | Pass | Note 1 |
| 30(161V) | 180 | 500 | <input checked="" type="checkbox"/> A <input type="checkbox"/> B <input type="checkbox"/> C | Pass | Note 1 |
| 30(161V) | 225 | 500 | <input checked="" type="checkbox"/> A <input type="checkbox"/> B <input type="checkbox"/> C | Pass | Note 1 |
| 30(161V) | 270 | 500 | <input checked="" type="checkbox"/> A <input type="checkbox"/> B <input type="checkbox"/> C | Pass | Note 1 |
| 30(161V) | 315 | 500 | <input checked="" type="checkbox"/> A <input type="checkbox"/> B <input type="checkbox"/> C | Pass | Note 1 |
| >95(0V) | 0 | 5000 | <input type="checkbox"/> A <input type="checkbox"/> B <input checked="" type="checkbox"/> C | Pass | Note 2 |
| >95(0V) | 45 | 5000 | <input type="checkbox"/> A <input type="checkbox"/> B <input checked="" type="checkbox"/> C | Pass | Note 2 |
| >95(0V) | 90 | 5000 | <input type="checkbox"/> A <input type="checkbox"/> B <input checked="" type="checkbox"/> C | Pass | Note 2 |
| >95(0V) | 135 | 5000 | <input type="checkbox"/> A <input type="checkbox"/> B <input checked="" type="checkbox"/> C | Pass | Note 2 |
| >95(0V) | 180 | 5000 | <input type="checkbox"/> A <input type="checkbox"/> B <input checked="" type="checkbox"/> C | Pass | Note 2 |
| >95(0V) | 225 | 5000 | <input type="checkbox"/> A <input type="checkbox"/> B <input checked="" type="checkbox"/> C | Pass | Note 2 |
| >95(0V) | 270 | 5000 | <input type="checkbox"/> A <input type="checkbox"/> B <input checked="" type="checkbox"/> C | Pass | Note 2 |
| >95(0V) | 315 | 5000 | <input type="checkbox"/> A <input type="checkbox"/> B <input checked="" type="checkbox"/> C | Pass | Note 2 |

Note: 1.

The acceptance criteria were met, and the EUT passed the test.

Criterion A : Operate as intended during and after the test

Criterion B : Operate as intended after the test

Criterion C : Loss/Error of function

 Additional Information

 EUT stopped operation and could / could be reset by operator at _____dBuV(V) at frequency _____MHz.

 No false alarms or other malfunctions were observed during or after the test.

2. The power is temporary off and can be reset by the operator.

5.7.6. Test Photograph

Test Mode : Mode 1

Description : Front View of Dips Test



6 EUT Photograph

(1) EUT Photo



(2) EUT Photo



(3) EUT Photo



(4) EUT Photo



(5) EUT Photo

