

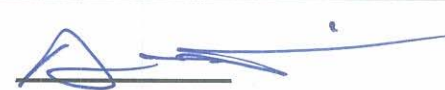



TEST REPORT	
EN 60950-1	
Information Technology Equipment – Safety – Part 1: General Requirements	
Test Report No.:	L110601-01-A0
Client	
Name :	VIVOTEK INC
Address :	6TH FL, 192 LIEN CHENG RD CHUNG HO DISTRICT, NEW TAIPEI CITY, 235 TAIWAN
Test Item :	Network Camera
Identification :	IP8352
Testing laboratory	
Name :	Prodigy Technology Consultant Co., Ltd.
Address :	No.181, Sec. 2, Wunhua 1st Rd., Linkou District, New Taipei City 244, Taiwan CHINESE TAIPEI
Test specification	
Standard :	EN 60950-1:2006+A11:2009+A1:2010
Test Result :	The test item passed.
Prepared By :	
	 Signature <u>Frank Chang</u> Senior Engineer
	<u>2011-08-30</u> Date
Approved By:	
	 Signature <u>Angus Hsu</u> General Manager
	<u>2011-08-30</u> Date
Other Aspects:	
The completed test report includes the following documents: <ul style="list-style-type: none"> ■ EN 60950-1 report (38 pages) ■ National Differences (13 pages) ■ Enclosures (12 pages) 	
	 
The test report shall not be reproduced except in full, without written approval of the laboratory. This test report does not entitle to carry any safety mark on this or similar products.	



TEST REPORT	
EN 60950-1	
Information Technology Equipment – Safety – Part 1: General Requirements	
Report Reference No.	L110601-01-A0
Tested by (+ signature)	See cover sheet
Approved by (+ signature).....	See cover sheet
Date of issue.....	2011-08-30
Testing laboratory	
Name	Prodigy Technology Consultant Co., Ltd.
Address	No.181, Sec. 2, Wunhua 1st Rd., Linkou District, New Taipei City 244, Taiwan CHINESE TAIPEI
Testing location	Prodigy Technology Consultant Co., Ltd.
Address	No.181, Sec. 2, Wunhua 1st Rd., Linkou District, New Taipei City 244, Taiwan CHINESE TAIPEI
Applicant	
Name	VIVOTEK INC
Address	6TH FL, 192 LIEN CHENG RD CHUNG HO DISTRICT, NEW TAIPEI CITY, 235 TAIWAN
Test specification	
Standard	EN 60950-1:2006+A11:2009+A1:2010
Test procedure	CE Marking serial in LVD
Procedure deviation	N/A
Non-standard test method.....	N/A
Test Report Form/blank test report	
Test Report Form No.	IEC60950_1B
TRF originator.	SGS Fimko Ltd
Master TRF	Dated 2010-04
Test equipment	
Description.....	Network Camera
Trademark	
Manufacturer	Same as applicant.
Model and/or type reference	IP8352
Rating(s).....	Optional, (1) 12Vdc, 1A, (2). 48Vdc, 350mA,(For PoE), (3). 24Vac(50/60Hz),900mA



Summary of Testing:

Unless otherwise indicated, all tests were conducted at Prodigy Technology Consultant Co., Ltd. No.181, Sec. 2, Wunhua 1st Rd., Linkou District, New Taipei City 244, Taiwan CHINESE TAIPEI.

Tests performed (name of test and test clause)	Testing location / Comments
END PRODUCT REFERENCE PAGE	
GENERAL GUIDELINES	
1.6.2 - INPUT TEST: SINGLE-PHASE	
2.2.2, 2.2.3, 2.2.4, PART 22 6.1 - SELV RELIABILITY TEST	
2.5 - LIMITED POWER SOURCE MEASUREMENTS	
2.10.2, PART 22 6.1 - DETERMINATION OF WORKING VOLTAGE - HAZARDOUS VOLTAGE (CIRCUIT) MEASUREMENT TEST	
4.2.1 - 4.2.4 – STEADY FORCE TESTS	
4.2.5, 4.2.1, PART 22 10.2 - IMPACT TEST	
4.2.10 - LOADING TESTS – WALL AND CEILING MOUNTED EQUIPMENT	
4.5.1, 1.4.12, 1.4.13 - HEATING TEST	

Copy of Marking Plate - Refer to Enclosure titled Marking Plate for copy.

The artwork below may be only a draft. The use of certification marks on a product must be authorized by the respective NCBs that own these marks. (Additional requirements for markings. See 1.7 NOTE)



<p>Particulars: test item vs. test requirements</p> <p>Equipment mobility : movable</p> <p>Operating condition : Continuous</p> <p>Mains supply tolerance (%) No direct connection</p> <p>Tested for IT power systems : No</p> <p>IT testing, phase-phase voltage (V) : N/A</p> <p>Class of equipment..... : Class III</p> <p>Mass of equipment (kg)..... : 1.1</p> <p>Protection against ingress of water : IP67</p>
<p>Test case verdicts</p> <p>Test case does not apply to the test object..... : N/A</p> <p>Test item does meet the requirement : Pass</p> <p>Test item does not meet the requirement : Fail</p>
<p>Testing</p> <p>Date of receipt of test item.: 2011-05-25</p> <p>Date(s) of performance of test.....: 2011-06-21 to 2011-07-08</p>
<p>General remarks</p> <p>This test report shall not be reproduced except in full without the written approval of the testing laboratory. The test results presented in this report relate only to the item tested.</p> <p>"(see remark #)" refers to a remark appended to the report.</p> <p>"(see appended table)" refers to a table appended to the report.</p> <p>Throughout this report a point is used as the decimal separator.</p> <p>Brief description of the test equipment</p> <ul style="list-style-type: none"> - The equipment is a Class III Network Camera, The EUT is equipped with a progressive scan CCD sensor and provides a general I/O terminal block which is used to connect external input/output devices. - The EUT installs to the ceiling or wall. The power source can choose to use PoE or external DC(AC) power adapter. - The maximum ambient temperature specified by manufacturer IP8352 is 50°C, <p>Model Differences</p> <p>N/A</p> <p>Additional Information</p> <p>N/A</p> <p>Factory Location(s):</p> <p>VIVOTEK INC. 5F, No.168, Lien-Cheng Rd., Chung-Ho District, New Taipei City, Taiwan, R.O.C.</p> <p>Test condition</p> <p>Temperature: 25°C Relative humidity: 60% Air pressure: 950 mbar</p> <p>The test samples are pre-production without serial numbers.</p>



EN 60950-1			
Clause	Requirement + Test	Result - Remark	Verdict
1	GENERAL		Pass
1.5	Components		Pass
1.5.1	General	See below.	Pass
	Comply with IEC 60950 or relevant component standard	(see appended table 1.5.1 for details.)	Pass
1.5.2	Evaluation and testing of components	<p>- Components certified to IEC harmonized standard and checked for correct application.</p> <p>- Components, for which no relevant IEC-Standard exist, have been tested under the conditions occurring in the equipment, using applicable parts of IEC 60950-1.</p> <p>- Components not certified are used in accordance with their ratings and they comply with applicable parts of IEC 60950-1 and the relevant component Standard.</p>	Pass
1.5.3	Thermal controls		N/A
1.5.4	Transformers		N/A
1.5.5	Interconnecting cables	Interconnecting cables comply with the relevant requirements of this standard.	Pass
1.5.6	Capacitors bridging insulation		N/A
1.5.7	Resistors bridging insulation		N/A
1.5.7.1	Resistors bridging functional, basic or supplementary insulation		N/A
1.5.7.2	Resistors bridging double or reinforced insulation between a.c. mains and other circuits		N/A
1.5.7.3	Resistors bridging double or reinforced insulation between a.c. mains and antenna or coaxial cable		N/A
1.5.8	Components in equipment for IT power systems		N/A
1.5.9	Surge suppressors		N/A
1.5.9.1	General		N/A
1.5.9.2	Protection of VDRs		N/A
1.5.9.3	Bridging of functional insulation by a VDR		N/A
1.5.9.4	Bridging of basic insulation by a VDR		N/A



EN 60950-1			
Clause	Requirement + Test	Result - Remark	Verdict

1.5.9.5	Bridging of supplementary, double or reinforced insulation by a VDR		N/A
---------	---	--	-----

1.6	Power interface		Pass
1.6.1	AC power distribution systems	The unit is supplied by SELV.	N/A
1.6.2	Input current	The steady state input current of the equipment did not exceed the RATED CURRENT by more than 10% under normal load See appended table 1.6.2 for details	Pass
1.6.3	Voltage limit of hand-held equipment	This is not a hand-held equipment.	N/A
1.6.4	Neutral conductor		N/A

1.7	Marking and instructions		Pass
1.7.1	Power rating and identification markings	Rating marking readily visible to operator. (Optional)	Pass
1.7.1.1	Power rating marking		Pass
	Multiple mains supply connections.....:		N/A
	Rated voltage(s) or voltage range(s) (V)	Optional, (1) 12Vdc (2). 48Vdc (For POE) (3). 24Vac	Pass
	Symbol for nature of supply, for d.c. only	⎓ (60417-2-IEC-5031) for 12Vdc and 48Vdc	Pass
	Rated frequency or frequency range (Hz)	50/60Hz for 24Vac	Pass
	Rated current (mA or A)	(1) 1A, (2) 350mA,(For PoE) (3).900mA	Pass
1.7.1.2	Identification markings		
	Manufacturer's name or trade-mark or identification mark	Manufacturer: VIVOTEK INC or Trademark: 	Pass
	Model identification or type reference	IP8352	Pass
	Symbol for Class II equipment only		N/A
	Other markings and symbols	Additional markings are used and are defined in the installation instructions.	Pass



EN 60950-1			
Clause	Requirement + Test	Result - Remark	Verdict
1.7.2	Safety instructions and marking	Safety instructions in English. Other languages will be provided when submitted for national approval.	Pass
1.7.2.1	General		Pass
1.7.2.2	Disconnect devices		N/A
1.7.2.3	Overcurrent protective device		N/A
1.7.2.4	IT power distribution systems		N/A
1.7.2.5	Operator access with a tool		N/A
1.7.2.6	Ozone		N/A
1.7.3	Short duty cycles	Equipment is designed for continuous operation.	N/A
1.7.4	Supply voltage adjustment	No adjustment can be made	N/A
	Methods and means of adjustment; reference to installation instructions		N/A
1.7.5	Power outlets on the equipment	No power outlets	N/A
1.7.6	Fuse identification (marking, special fusing characteristics, cross-reference)		N/A
1.7.7	Wiring terminals		N/A
1.7.7.1	Protective earthing and bonding terminals	Evaluated as part of power supply	N/A
1.7.7.2	Terminal for a.c. mains supply conductors		N/A
1.7.7.3	Terminals for d.c. mains supply conductors	No permanently connected equipment.	N/A
1.7.8	Controls and indicators		N/A
1.7.8.1	Identification, location and marking		N/A
1.7.8.2	Colours		N/A
1.7.8.3	Symbols according to IEC 60417		N/A
1.7.8.4	Markings using figures		N/A
1.7.9	Isolation of multiple power sources		N/A
1.7.10	Thermostats and other regulating devices		N/A
1.7.11	Durability	Comply with the durability test	Pass
1.7.12	Removable parts	No marking is located on a removable parts.	Pass
1.7.13	Replaceable batteries	No batteries provided.	N/A
	Language(s)		--
1.7.14	Equipment for restricted access locations		N/A



EN 60950-1			
Clause	Requirement + Test	Result - Remark	Verdict

2	PROTECTION FROM HAZARDS		Pass
---	--------------------------------	--	------

2.1	Protection from electric shock and energy hazards		Pass
2.1.1	Protection in operator access areas	See below	Pass
2.1.1.1	Access to energized parts	See below	Pass
	Test by inspection	All accessible circuits are SELV circuits	Pass
	Test with test finger (Figure 2A)		Pass
	Test with test pin (Figure 2B)		Pass
	Test with test probe (Figure 2C)	No TNV present	N/A
2.1.1.2	Battery compartments		N/A
2.1.1.3	Access to ELV wiring	No ELV wiring in operator accessible area.	N/A
	Working voltage (V_{peak} or V_{rms}); minimum distance through insulation (mm)		—
2.1.1.4	Access to hazardous voltage circuit wiring		N/A
2.1.1.5	Energy hazards	No hazardous energy in operator access area	Pass
2.1.1.6	Manual controls		N/A
2.1.1.7	Discharge of capacitors in equipment		N/A
	Measured voltage (V); time-constant (s)		—
2.1.1.8	Energy hazards – d.c. mains supply		N/A
	a) Capacitor connected to the d.c. mains supply		N/A
	b) Internal battery connected to the d.c. mains supply		N/A
2.1.1.9	Audio amplifiers		N/A
2.1.2	Protection in service access areas		N/A
2.1.3	Protection in restricted access locations		N/A

2.2	SELV circuits		Pass
2.2.1	General requirements	The unit intended to be supplied by SELV.	Pass
2.2.2	Voltages under normal conditions (V)	All accessible voltage are less than 42.4Vp or 60Vdc and are classified as SELV.	Pass



EN 60950-1			
Clause	Requirement + Test	Result - Remark	Verdict

2.2.3	Voltages under fault conditions (V)..... :	Under fault conditions voltages never exceed 71 Vpeak and 120 Vdc and do not exceed 42.4 V peak or 60 V dc for more than 0.2 sec.	Pass
2.2.4	Connection of SELV circuits to other circuits..... :	SELV circuits are only connected to other SELV circuit.	Pass

2.3	TNV circuits		N/A
2.3.1	Limits	No TNV circuit.	N/A
	Type of TNV circuits		—
2.3.2	Separation from other circuits and from accessible parts		N/A
2.3.2.1	General requirements		N/A
2.3.2.2	Protection by basic insulation		N/A
2.3.2.3	Protection by earthing		N/A
2.3.2.4	Protection by other constructions		N/A
2.3.3	Separation from hazardous voltages		N/A
	Insulation employed		—
2.3.4	Connection of TNV circuits to other circuits		N/A
	Insulation employed		—
2.3.5	Test for operating voltages generated externally		N/A

2.4	Limited current circuits		N/A
2.4.1	General requirements		N/A
2.4.2	Limit values		N/A
	Frequency (Hz)		—
	Measured current (mA)..... :		—
	Measured voltage (V)		—
	Measured capacitance (nF or μ F)		—
2.4.3	Connection of limited current circuits to other circuits		N/A

2.5	Limited power sources		Pass
	a) Inherently limited output	See table 2.5 for details	Pass



EN 60950-1			
Clause	Requirement + Test	Result - Remark	Verdict

	b) Impedance limited output		N/A
	c) Regulating network limited output under normal operating and single fault condition	See table 2.5 for details	Pass
	d) Overcurrent protective device limited output		N/A
	Max. output voltage (V), max. output current (A), max. apparent power (VA).....	See table 2.5 for details	—
	Current rating of overcurrent protective device (A)		—
	Use of integrated circuit (IC) current limiters		—

2.6	Provisions for earthing and bonding		N/A
2.6.1	Protective earthing	Class III equipment.	N/A
2.6.2	Functional earthing		N/A
2.6.3	Protective earthing and protective bonding conductors		N/A
2.6.3.1	General		N/A
2.6.3.2	Size of protective earthing conductors		N/A
	Rated current (A), cross-sectional area (mm ²), AWG.....		—
2.6.3.3	Size of protective bonding conductors		N/A
	Rated current (A), cross-sectional area (mm ²), AWG.....		—
	Protective current rating (A), cross-sectional area (mm ²), AWG.....		—
2.6.3.4	Resistance of earthing conductors and their terminations; resistance (Ω), voltage drop (V), test current (A), duration (min).....		N/A
2.6.3.5	Colour of insulation.....		N/A
2.6.4	Terminals		N/A
2.6.4.1	General		N/A
2.6.4.2	Protective earthing and bonding terminals		N/A
	Rated current (A), type and nominal thread diameter (mm).....		—
2.6.4.3	Separation of the protective earthing conductor from protective bonding conductors		N/A
2.6.5	Integrity of protective earthing		—
2.6.5.1	Interconnection of equipment		N/A



EN 60950-1			
Clause	Requirement + Test	Result - Remark	Verdict

2.6.5.2	Components in protective earthing conductors and protective bonding conductors		N/A
2.6.5.3	Disconnection of protective earth		N/A
2.6.5.4	Parts that can be removed by an operator		N/A
2.6.5.5	Parts removed during servicing		N/A
2.6.5.6	Corrosion resistance		N/A
2.6.5.7	Screws for protective bonding		N/A
2.6.5.8	Reliance on telecommunication network or cable distribution system		N/A

2.7	Overcurrent and earth fault protection in primary circuits		N/A
2.7.1	Basic requirements	Class III equipment.	N/A
	Instructions when protection relies on building installation		N/A
2.7.2	Faults not simulated in 5.3.7		N/A
2.7.3	Short-circuit backup protection		N/A
2.7.4	Number and location of protective devices		N/A
2.7.5	Protection by several devices		N/A
2.7.6	Warning to service personnel		N/A

2.8	Safety interlocks		N/A
2.8.1	General principles	No safety interlocks provided.	N/A
2.8.2	Protection requirements		N/A
2.8.3	Inadvertent reactivation		N/A
2.8.4	Fail-safe operation		N/A
	Protection against extreme hazard		N/A
2.8.5	Moving parts		N/A
2.8.6	Overriding		N/A
2.8.7	Switches and relays		N/A
2.8.7.1	Contact gaps (mm)		N/A
2.8.7.2	Overload test		N/A
2.8.7.3	Endurance test		N/A
2.8.7.4	Electric strength test (V)		N/A
2.8.8	Mechanical actuators		N/A



EN 60950-1			
Clause	Requirement + Test	Result - Remark	Verdict

2.9	Electrical insulation		N/A
2.9.1	Properties of insulating materials		N/A
2.9.2	Humidity conditioning		N/A
	Relative humidity (%), temperature (°C)		—
2.9.3	Grade of insulation		N/A
2.9.4	Separation from hazardous voltages		N/A
	Method(s) used		—

2.10	Clearances, creepage distances and distances through insulation		Pass
2.10.1	General	Pollution Degree 2 applicable.	Pass
2.10.1.1	Frequency		N/A
2.10.1.2	Pollution degrees	Pollution degree 2 applicable	Pass
2.10.1.3	Reduced values for functional insulation	Functional insulation	Pass
2.10.1.4	Intervening unconnected conductive parts		N/A
2.10.1.5	Insulation with varying dimensions		N/A
2.10.1.6	Special separation requirements		N/A
2.10.1.7	Insulation in circuits generating starting pulses		N/A
2.10.2	Determination of working voltage	See appended table 2.10.2 for details	Pass
2.10.2.1	General		Pass
2.10.2.2	RMS working voltage		Pass
2.10.2.3	Peak working voltage		Pass
2.10.3	Clearances	Functional insulation	Pass
2.10.3.1	General		Pass
2.10.3.2	Mains transient voltages		N/A
	a) AC mains supply		N/A
	b) Earthed d.c. mains supplies		N/A
	c) Unearthed d.c. mains supplies		N/A
	d) Battery operation		N/A
2.10.3.3	Clearances in primary circuits		N/A
2.10.3.4	Clearances in secondary circuits	Functional insulation.	Pass
2.10.3.5	Clearances in circuits having starting pulses		N/A
2.10.3.6	Transients from a.c. mains supply		N/A



EN 60950-1			
Clause	Requirement + Test	Result - Remark	Verdict
2.10.3.7	Transients from d.c. mains supply		N/A
2.10.3.8	Transients from telecommunication networks and cable distribution systems		N/A
2.10.3.9	Measurement of transient voltage levels		N/A
	a) Transients from a mains supply		N/A
	For an a.c. mains supply		N/A
	For a d.c. mains supply		N/A
	b) Transients from a telecommunication network .		N/A
2.10.4	Creepage distances	Functional insulation	Pass
2.10.4.1	General		Pass
2.10.4.2	Material group and comparative tracking index		N/A
	CTI tests.....		—
2.10.4.3	Minimum creepage distances		N/A
2.10.5	Solid insulation		N/A
2.10.5.1	General		N/A
2.10.5.2	Distances through insulation		N/A
2.10.5.3	Insulating compound as solid insulation		N/A
2.10.5.4	Semiconductor devices		N/A
2.10.5.5.	Cemented joints		N/A
2.10.5.6	Thin sheet material – General		N/A
2.10.5.7	Separable thin sheet material		N/A
	Number of layers (pcs)		—
2.10.5.8	Non-separable thin sheet material		N/A
2.10.5.9	Thin sheet material – standard test procedure		N/A
	Electric strength test		—
2.10.5.10	Thin sheet material – alternative test procedure		N/A
	Electric strength test		—
2.10.5.11	Insulation in wound components		N/A
2.10.5.12	Wire in wound components		N/A
	Working voltage		N/A
	a) Basic insulation not under stress		N/A
	b) Basic, supplementary, reinforced insulation		N/A
	c) Compliance with Annex U		N/A



EN 60950-1			
Clause	Requirement + Test	Result - Remark	Verdict

	Two wires in contact inside wound component; angle between 45° and 90°		N/A
2.10.5.13	Wire with solvent-based enamel in wound components		N/A
	Electric strength test		—
	Routine test		N/A
2.10.5.14	Additional insulation in wound components		N/A
	Working voltage		N/A
	- Basic insulation not under stress		N/A
	- Supplementary, reinforced insulation		N/A
2.10.6	Construction of printed boards		N/A
2.10.6.1	Uncoated printed boards		N/A
2.10.6.2	Coated printed boards		N/A
2.10.6.3	Insulation between conductors on the same inner surface of a printed board		N/A
2.10.6.4	Insulation between conductors on different layers of a printed board		N/A
	Distance through insulation		N/A
	Number of insulation layers (pcs)		N/A
2.10.7	Component external terminations		N/A
2.10.8	Tests on coated printed boards and coated components		N/A
2.10.8.1	Sample preparation and preliminary inspection		N/A
2.10.8.2	Thermal conditioning		N/A
2.10.8.3	Electric strength test		N/A
2.10.8.4	Abrasion resistance test		N/A
2.10.9	Thermal cycling		N/A
2.10.10	Test for Pollution Degree 1 environment and insulating compound		N/A
2.10.11	Tests for semiconductor devices and cemented joints		N/A
2.10.12	Enclosed and sealed parts		N/A

3	WIRING, CONNECTIONS AND SUPPLY		Pass
---	---------------------------------------	--	------



EN 60950-1			
Clause	Requirement + Test	Result - Remark	Verdict

3.1	General		Pass
3.1.1	Current rating and overcurrent protection	All wires/conductors possess adequate cross-sectional areas for their intended application and internal wiring are adequately insulated.	Pass
3.1.2	Protection against mechanical damage	The wires are well routed away from sharp edges , etc. and are adequately fixed to prevent excessive strain on wire and terminals	Pass
3.1.3	Securing of internal wiring	The wires are positioned in such a manner that prevents excessive strain, loosening of terminal connections and damage of conductor.	Pass
3.1.4	Insulation of conductors		N/A
3.1.5	Beads and ceramic insulators		N/A
3.1.6	Screws for electrical contact pressure		N/A
3.1.7	Insulating materials in electrical connections	No contact pressure through insulating material.	Pass
3.1.8	Self-tapping and spaced thread screws		N/A
3.1.9	Termination of conductors		N/A
	10 N pull test		N/A
3.1.10	Sleeving on wiring		N/A

3.2	Connection to a mains supply		N/A
3.2.1	Means of connection	Class III equipment.	N/A
3.2.1.1	Connection to an a.c. mains supply		N/A
3.2.1.2	Connection to a d.c. mains supply		N/A
3.2.2	Multiple supply connections		N/A
3.2.3	Permanently connected equipment		N/A
	Number of conductors, diameter of cable and conduits (mm)		—
3.2.4	Appliance inlets		N/A
3.2.5	Power supply cords		N/A
3.2.5.1	AC Power supply cords		N/A
	Type		—



EN 60950-1			
Clause	Requirement + Test	Result - Remark	Verdict

	Rated current (A), cross-sectional area (mm ²), AWG	—
3.2.5.2	DC power supply cords		N/A
3.2.6	Cord anchorages and strain relief		N/A
	Mass of equipment (kg), pull (N)		—
	Longitudinal displacement (mm)		—
3.2.7	Protection against mechanical damage		N/A
3.2.8	Cord guards		N/A
	D (mm); test mass (g)		—
	Radius of curvature of cord (mm).....		—
3.2.9	Supply wiring space		N/A

3.3	Wiring terminals for connection of external conductors		N/A
3.3.1	Wiring terminals	Class III equipment.	N/A
3.3.2	Connection of non-detachable power supply cords		N/A
3.3.3	Screw terminals		N/A
3.3.4	Conductor sizes to be connected		N/A
	Rated current (A), cord/cable type, cross-sectional area (mm ²).....		—
3.3.5	Wiring terminals sizes		N/A
	Rated current (A), type, nominal thread diameter (mm).....		—
3.3.6	Wiring terminals design		N/A
3.3.7	Grouping of wiring terminals		N/A
3.3.8	Standard wire		N/A

3.4	Disconnection from the mains supply		N/A
3.4.1	General requirement	Class III equipment.	N/A
3.4.2	Disconnect devices		N/A
3.4.3	Permanently connected equipment		N/A
3.4.4	Parts which remain energised		N/A
3.4.5	Switches in flexible cords		N/A
3.4.6	Number of poles - single-phase and d.c. equipment		N/A



EN 60950-1			
Clause	Requirement + Test	Result - Remark	Verdict

3.4.7	Number of poles - three-phase equipment		N/A
3.4.8	Switches as disconnect devices		N/A
3.4.9	Plugs as disconnect devices		N/A
3.4.10	Interconnected equipment		N/A
3.4.11	Multiple power sources		N/A

3.5	Interconnection of equipment		Pass
3.5.1	General requirements		Pass
3.5.2	Types of interconnection circuits	Interconnection circuits are SELV	Pass
3.5.3	ELV circuits as interconnection circuits	No ELV interconnections.	N/A
3.5.4	Data ports for additional equipment	Complied with LPS, See table 2.5 for details.	Pass

4	PHYSICAL REQUIREMENTS		Pass
---	------------------------------	--	------

4.1	Stability		N/A
	Angle of 10°	The equipment less than 7 kg	N/A
	Test: force (N)	Not floor standing equipment.	N/A

4.2	Mechanical strength		Pass
4.2.1	General		Pass
4.2.2	Steady force test, 10 N		N/A
4.2.3	Steady force test, 30 N		N/A
4.2.4	Steady force test, 250 N		Pass
4.2.5	Impact test		Pass
	Fall test		Pass
	Swing test		Pass
4.2.6	Drop test; height (mm)		N/A
4.2.7	Stress relief	Metal enclosure	N/A
4.2.8	Cathode ray tubes	No CRT provided.	N/A
	Picture tube separately certified		N/A
4.2.9	High pressure lamps	No high pressure lamp provided.	N/A



EN 60950-1			
Clause	Requirement + Test	Result - Remark	Verdict

4.2.10	Wall or ceiling mounted equipment; force (N) ...:	Mounting means withstands four times unit weight or 50N minimum. Force applied: 50N.	Pass
4.2.11	Rotating solid media		N/A
	Test to cover on the door.....:		N/A

4.3	Design and construction		Pass
4.3.1	Edges and corners	All edges and corners are judged to be sufficiently well rounded so as not to constitute a hazard.	Pass
4.3.2	Handles and manual controls; force (N).....:		N/A
4.3.3	Adjustable controls		N/A
4.3.4	Securing of parts		N/A
4.3.5	Connection by plugs and sockets		N/A
4.3.6	Direct plug-in equipment	Not direct plug-in equipment.	N/A
	Torque		—
	Compliance with the relevant mains plug standard		N/A
4.3.7	Heating elements in earthed equipment	No heating element.	N/A
4.3.8	Batteries	No battery.	N/A
	- Overcharging of a rechargeable battery		N/A
	- Unintentional charging of a non-rechargeable battery		N/A
	- Reverse charging of a rechargeable battery		N/A
	- Excessive discharging rate for any battery		N/A
4.3.9	Oil and grease	No oil or grease.	N/A
4.3.10	Dust, powders, liquids and gases		N/A
4.3.11	Containers for liquids or gases	No liquids or gases.	N/A
4.3.12	Flammable liquids.....:	No flammable liquids.	N/A
	Quantity of liquid (l).....:		N/A
	Flash point (°C).....:		N/A
4.3.13	Radiation		N/A
4.3.13.1	General		N/A



EN 60950-1			
Clause	Requirement + Test	Result - Remark	Verdict

4.3.13.2	Ionizing radiation		N/A
	Measured radiation (pA/kg)		—
	Measured high-voltage (kV)		—
	Measured focus voltage (kV)		—
	CRT markings		—
4.3.13.3	Effect of ultraviolet (UV) radiation on materials		N/A
	Part, property, retention after test, flammability classification		N/A
4.3.13.4	Human exposure to ultraviolet (UV) radiation ...:		N/A
4.3.13.5	Laser (including LEDs)		N/A
	Laser class	1	—
4.3.13.6	Other types		N/A

4.4	Protection against hazardous moving parts		N/A
4.4.1	General		N/A
4.4.2	Protection in operator access areas		N/A
4.4.3	Protection in restricted access locations		N/A
4.4.4	Protection in service access areas		N/A
4.4.5	Protection against moving fan blades		N/A
4.4.5.1	General		N/A
	Not considered to cause pain or injury. a).....:		N/A
	Is considered to cause pain, not injury. b)		N/A
	Considered to cause injury. c)		N/A
4.4.5.2	Protection for users		N/A
	Use of symbol or warning		N/A
4.4.5.3	Protection for service persons		N/A
	Use of symbol or warning		N/A

4.5	Thermal requirements		Pass
4.5.1	General	See appended table 4.5.1 for details	Pass
4.5.2	Temperature tests		Pass



EN 60950-1			
Clause	Requirement + Test	Result - Remark	Verdict

	Normal load condition per Annex L	See appended table 4.5.1 for details	--
4.5.3	Temperature limits for materials		Pass
4.5.4	Touch temperature limits		Pass
4.5.5	Resistance to abnormal heat		N/A

4.6	Openings in enclosures		Pass
4.6.1	Top and side openings	No opening	Pass
	Dimensions (mm)		—
4.6.2	Bottoms of fire enclosures	No opening	Pass
	Construction of the bottom, dimensions (mm)		—
4.6.3	Doors or covers in fire enclosures		N/A
4.6.4	Openings in transportable equipment		N/A
4.6.4.1	Constructional design measures		N/A
	Dimensions (mm)		—
4.6.4.2	Evaluation measures for larger openings		N/A
4.6.4.3	Use of metallized parts		N/A
4.6.5	Adhesives for constructional purposes		N/A
	Conditioning temperature (°C), time (weeks).....		—

4.7	Resistance to fire		Pass
4.7.1	Reducing the risk of ignition and spread of flame	Method 1: Selection and application of components and materials which minimize the possibility of ignition and spread of flame.	Pass
	Method 1, selection and application of components wiring and materials	See appended table 1.5.1	Pass
	Method 2, application of all of simulated fault condition tests		N/A
4.7.2	Conditions for a fire enclosure		N/A
4.7.2.1	Parts requiring a fire enclosure	Powered by LPS	N/A
4.7.2.2	Parts not requiring a fire enclosure		Pass
4.7.3	Materials	HB Min.	Pass
4.7.3.1	General	See below.	Pass
4.7.3.2	Materials for fire enclosures		N/A



EN 60950-1			
Clause	Requirement + Test	Result - Remark	Verdict

4.7.3.3	Materials for components and other parts outside fire enclosures	HB Min.	Pass
4.7.3.4	Materials for components and other parts inside fire enclosures	All internal materials are rated V-2 or better or are mounted on a PWB rated V-1 or better. Internal wiring is UL Recognized, rated VW-1 or FT-1. (See appended table 1.5.1)	Pass
4.7.3.5	Materials for air filter assemblies		N/A
4.7.3.6	Materials used in high-voltage components		N/A

5	ELECTRICAL REQUIREMENTS AND SIMULATED ABNORMAL CONDITIONS		Pass
---	--	--	------

5.1	Touch current and protective conductor current		N/A
5.1.1	General	Class III equipment	N/A
5.1.2	Configuration of equipment under test (EUT)		N/A
5.1.2.1	Single connection to an a.c. mains supply		N/A
5.1.2.2	Redundant multiple connections to an a.c. mains supply		N/A
5.1.2.3	Simultaneous multiple connections to an a.c. mains supply		N/A
5.1.3	Test circuit		N/A
5.1.4	Application of measuring instrument		N/A
5.1.5	Test procedure		N/A
5.1.6	Test measurements		N/A
	Supply voltage (V)		—
	Measured touch current (mA)		—
	Max. allowed touch current (mA)		—
	Measured protective conductor current (mA)		—
	Max. allowed protective conductor current (mA) :		—
5.1.7	Equipment with touch current exceeding 3,5 mA		N/A
5.1.7.1	General		N/A
5.1.7.2	Simultaneous multiple connections to the supply		N/A



EN 60950-1			
Clause	Requirement + Test	Result - Remark	Verdict

5.1.8	Touch currents to and from telecommunication networks and cable distribution systems and from telecommunication networks		N/A
5.1.8.1	Limitation of the touch current to a telecommunication network or to a cable distribution system		N/A
	Supply voltage (V)		—
	Measured touch current (mA)		—
	Max. allowed touch current (mA)		—
5.1.8.2	Summation of touch currents from telecommunication networks		N/A
	a) EUT with earthed telecommunication ports		N/A
	b) EUT whose telecommunication ports have no reference to protective earth		N/A

5.2	Electric strength		N/A
5.2.1	General	Class III equipment	N/A
5.2.2	Test procedure		N/A

5.3	Abnormal operating and fault conditions		Pass
5.3.1	Protection against overload and abnormal operation		N/A
5.3.2	Motors		N/A
5.3.3	Transformers		N/A
5.3.4	Functional insulation	Functional insulation complies with the requirements. (Method C)	Pass
5.3.5	Electromechanical components		N/A
5.3.6	Audio amplifiers in ITE		N/A
5.3.7	Simulation of faults		N/A
5.3.8	Unattended equipment		N/A
5.3.9	Compliance criteria for abnormal operating and fault conditions		N/A
5.3.9.1	During the tests		N/A
5.3.9.2	After the tests		N/A



EN 60950-1			
Clause	Requirement + Test	Result - Remark	Verdict

6	CONNECTION TO TELECOMMUNICATION NETWORKS		N/A
---	---	--	-----

6.1	Protection of telecommunication network service personnel, and users of other equipment connected to the network, from hazards in the equipment		N/A
6.1.1	Protection from hazardous voltages		N/A
6.1.2	Separation of the telecommunication network from earth		N/A
6.1.2.1	Requirements		N/A
	Supply voltage (V)		—
	Current in the test circuit (mA)		—
6.1.2.2	Exclusions.....		N/A

6.2	Protection of equipment users from overvoltages on telecommunication networks		N/A
6.2.1	Separation requirements		N/A
6.2.2	Electric strength test procedure		N/A
6.2.2.1	Impulse test		N/A
6.2.2.2	Steady-state test		N/A
6.2.2.3	Compliance criteria		N/A

6.3	Protection of telecommunication wiring system from overheating		N/A
	Max. output current (A)		—
	Current limiting method		—

7	CONNECTION TO CABLE DISTRIBUTION SYSTEMS		N/A
---	---	--	-----

7.1	General		N/A
7.2	Protection of cable distribution system service persons, and users of other equipment connected to the system, from hazardous voltages in the equipment		N/A
7.3	Protection of equipment users from overvoltages on the cable distribution system		N/A
7.4	Insulation between primary circuits and cable distribution systems		N/A
7.4.1	General		N/A



EN 60950-1			
Clause	Requirement + Test	Result - Remark	Verdict
7.4.2	Voltage surge test		N/A
7.4.3	Impulse test		N/A



EN 60950-1			
Clause	Requirement + Test	Result - Remark	Verdict

A	ANNEX A, TESTS FOR RESISTANCE TO HEAT AND FIRE		N/A
A.1	Flammability test for fire enclosures of movable equipment having a total mass exceeding 18 kg, and of stationary equipment (see 4.7.3.2)		N/A
A.1.1	Samples		N/A
	Wall thickness (mm).....:		—
A.1.2	Conditioning of samples; temperature (°C)		N/A
A.1.3	Mounting of samples.....:		N/A
A.1.4	Test flame (see IEC 60695-11-3)		N/A
	Flame A, B, C or D		—
A.1.5	Test procedure		N/A
A.1.6	Compliance criteria		N/A
	Sample 1 burning time (s).....:		—
	Sample 2 burning time (s).....:		—
	Sample 3 burning time (s).....:		—
A.2	Flammability test for fire enclosures of movable equipment having a total mass not exceeding 18 kg, and for material and components located inside fire enclosures (see 4.7.3.2 and 4.7.3.4)		N/A
A.2.1	Samples		N/A
	Wall thickness (mm).....:		—
A.2.2	Conditioning of samples; temperature (°C)		N/A
A.2.3	Mounting of samples.....:		N/A
A.2.4	Test flame (see IEC 60695-11-4)		N/A
	Flame A, B or C		—
A.2.5	Test procedure		N/A
A.2.6	Compliance criteria		N/A
	Sample 1 burning time (s).....:		—
	Sample 2 burning time (s).....:		—
	Sample 3 burning time (s).....:		—
A.2.7	Alternative test acc. to IEC 60695-11-5, cl. 5 and 9		N/A
	Sample 1 burning time (s).....:		—
	Sample 2 burning time (s).....:		—
	Sample 3 burning time (s).....:		—
A.3	Hot flaming oil test (see 4.6.2)		N/A



EN 60950-1			
Clause	Requirement + Test	Result - Remark	Verdict

A.3.1	Mounting of samples		N/A
A.3.2	Test procedure		N/A
A.3.3	Compliance criterion		N/A

B	ANNEX B, MOTOR TESTS UNDER ABNORMAL CONDITIONS (see 4.7.2.2 and 5.3.2)		N/A
B.1	General requirements		N/A
	Position		—
	Manufacturer		—
	Type		—
	Rated values		—
B.2	Test conditions		N/A
B.3	Maximum temperatures		N/A
B.4	Running overload test		N/A
B.5	Locked-rotor overload test		N/A
	Test duration (days)		—
	Electric strength test: test voltage (V)		—
B.6	Running overload test for DC motors in secondary circuits		N/A
B.6.1	General		N/A
B.6.2	Test procedure		N/A
B.6.3	Alternative test procedure		N/A
B.6.4	Electric strength test; test voltage (V)		N/A
B.7	Locked-rotor overload test for DC motors in secondary circuits		N/A
B.7.1	General		N/A
B.7.2	Test procedure		N/A
B.7.3	Alternative test procedure		N/A
B.7.4	Electric strength test; test voltage (V)		N/A
B.8	Test for motors with capacitors		N/A
B.9	Test for three-phase motors		N/A
B.10	Test for series motors		N/A
	Operating voltage (V)		—



EN 60950-1			
Clause	Requirement + Test	Result - Remark	Verdict

C	ANNEX C, TRANSFORMERS (see 1.5.4 and 5.3.3)		N/A
	Position		—
	Manufacturer		—
	Type		—
	Rated values		—
	Method of protection		—
C.1	Overload test		N/A
C.2	Insulation		N/A
	Protection from displacement of windings		—

D	ANNEX D, MEASURING INSTRUMENTS FOR TOUCH-CURRENT TESTS (see 5.1.4)		N/A
D.1	Measuring instrument		N/A
D.2	Alternative measuring instrument		N/A

E	ANNEX E, TEMPERATURE RISE OF A WINDING (see 1.4.13)		N/A
---	--	--	-----

F	ANNEX F, MEASUREMENT OF CLEARANCES AND CREEPAGE DISTANCES (see 2.10 and Annex G)		Pass
---	---	--	------

G	ANNEX G, ALTERNATIVE METHOD FOR DETERMINING MINIMUM CLEARANCES		N/A
G.1	Clearances		N/A
G.1.1	General		N/A
G.1.2	Summary of the procedure for determining minimum clearances		N/A
G.2	Determination of mains transient voltage (V)		N/A
G.2.1	AC mains supply		N/A
G.2.2	Earthed d.c. mains supplies		N/A
G.2.3	Unearthed d.c. mains supplies		N/A



EN 60950-1			
Clause	Requirement + Test	Result - Remark	Verdict

G.2.4	Battery operation		N/A
G.3	Determination of telecommunication network transient voltage (V)		N/A
G.4	Determination of required withstand voltage (V)		N/A
G.4.1	Mains transients and internal repetitive peaks		N/A
G.4.2	Transients from telecommunication networks		N/A
G.4.3	Combination of transients		N/A
G.4.4	Transients from cable distribution systems		N/A
G.5	Measurement of transient voltages (V)		N/A
	a) Transients from a mains supply		N/A
	For an a.c. mains supply		N/A
	For a d.c. mains supply		N/A
	b) Transients from a telecommunication network		N/A
G.6	Determination of minimum clearances		N/A

H	ANNEX H, IONIZING RADIATION (see 4.3.13)		N/A
---	---	--	-----

J	ANNEX J, TABLE OF ELECTROCHEMICAL POTENTIALS (see 2.6.5.6)		N/A
	Metal(s) used		—

K	ANNEX K, THERMAL CONTROLS (see 1.5.3 and 5.3.8)		N/A
K.1	Making and breaking capacity	No thermal control.	N/A
K.2	Thermostat reliability; operating voltage (V)		N/A
K.3	Thermostat endurance test; operating voltage(V):		N/A
K.4	Temperature limiter endurance; operating voltage (V)		N/A
K.5	Thermal cut-out reliability		N/A
K.6	Stability of operation		N/A

L	ANNEX L, NORMAL LOAD CONDITIONS FOR SOME TYPES OF ELECTRICAL BUSINESS EQUIPMENT (see 1.2.2.1 and 4.5.2)		Pass
L.1	Typewriters		N/A
L.2	Adding machines and cash registers		N/A



EN 60950-1			
Clause	Requirement + Test	Result - Remark	Verdict

L.3	Erasers		N/A
L.4	Pencil sharpeners		N/A
L.5	Duplicators and copy machines		N/A
L.6	Motor-operated files		N/A
L.7	Other business equipment		Pass

M	ANNEX M, CRITERIA FOR TELEPHONE RINGING SIGNALS (see 2.3.1)		N/A
M.1	Introduction		N/A
M.2	Method A		N/A
M.3	Method B		N/A
M.3.1	Ringling signal		N/A
M.3.1.1	Frequency (Hz)		N/A
M.3.1.2	Voltage (V)		N/A
M.3.1.3	Cadence; time (s), voltage (V)		N/A
M.3.1.4	Single fault current (mA)		N/A
M.3.2	Tripping device and monitoring voltage		N/A
M.3.2.1	Conditions for use of a tripping device or a monitoring voltage		N/A
M.3.2.2	Tripping device		N/A
M.3.2.3	Monitoring voltage (V)		N/A

N	ANNEX N, IMPULSE TEST GENERATORS (see 1.5.7.2, 1.5.7.3, 2.10.3.9, 6.2.2.1, 7.3.2, 7.4.3 and Clause G.5)		N/A
N.1	ITU-T impulse test generators		N/A
N.2	IEC 60065 impulse test generator		N/A

P	ANNEX P, NORMATIVE REFERENCES		Pass
---	--------------------------------------	--	------

Q	ANNEX Q, Voltage dependent resistors (VDRs) (see 1.5.9.1)		N/A
	a) Preferred climatic categories		N/A
	b) Maximum continuous voltage		N/A
	c) Pulse current		N/A



EN 60950-1			
Clause	Requirement + Test	Result - Remark	Verdict

R	ANNEX R, EXAMPLES OF REQUIREMENTS FOR QUALITY CONTROL PROGRAMMES		N/A
R.1	Minimum separation distances for unpopulated coated printed boards (see 2.10.6.2)		N/A
R.2	Reduced clearances (see 2.10.3)		N/A

S	ANNEX S, PROCEDURE FOR IMPULSE TESTING (see 6.2.2.3)		N/A
S.1	Test equipment		N/A
S.2	Test procedure		N/A
S.3	Examples of waveforms during impulse testing		N/A

T	ANNEX T, GUIDANCE ON PROTECTION AGAINST INGRESS OF WATER (see 1.1.2)		N/A
	Separate test report		—

U	ANNEX U, INSULATED WINDING WIRES FOR USE WITHOUT INTERLEAVED INSULATION (see 2.10.5.4)		N/A
	Separate test report		N/A

V	ANNEX V, AC POWER DISTRIBUTION SYSTEMS (see 1.6.1)		N/A
V.1	Introduction		N/A
V.2	TN power systems		N/A

W	ANNEX W, SUMMATION OF TOUCH CURRENTS		N/A
W.1	Touch current from electronic circuits		N/A
W.1.1	Floating circuits		N/A
W.1.2	Earthed circuits		N/A
W.2	Interconnection of several equipments		N/A
W.2.1	Isolation		N/A



EN 60950-1			
Clause	Requirement + Test	Result - Remark	Verdict

W.2.2	Common return, isolated from earth		N/A
W.2.3	Common return, connected to protective earth		N/A
X	ANNEX X, MAXIMUM HEATING EFFECT IN TRANSFORMER TESTS (see clause C.1)		N/A
X.1	Determination of maximum input current		N/A
X.2	Overload test procedure		N/A

Y	ANNEX Y, ULTRAVIOLET LIGHT CONDITIONING TEST (see 4.3.13.3)		N/A
Y.1	Test apparatus		N/A
Y.2	Mounting of test samples		N/A
Y.3	Carbon-arc light-exposure apparatus		N/A
Y.4	Xenon-arc light exposure apparatus		N/A

Z	ANNEX Z, OVERVOLTAGE CATEGORIES (see 2.10.3.2 and Clause G.2)		N/A
---	--	--	-----

AA	ANNEX AA, MANDREL TEST (see 2.10.5.8)		N/A
----	--	--	-----

BB	ANNEX BB, CHANGES IN THE SECOND EDITION		N/A
----	--	--	-----

CC	ANNEX CC, Evaluation of integrated circuit (IC) current limiters		N/A
CC.1	General		N/A
CC.2	Test program 1.....		N/A
CC.3	Test program 2.....		N/A

DD	ANNEX DD, Requirements for the mounting means of rack-mounted equipment		N/A
DD.1	General		N/A
DD.2	Mechanical strength test, variable N.....		N/A
DD.3	Mechanical strength test, 250N, including end stops.....		N/A
DD.4	Compliance.....		N/A

EE	ANNEX EE, Household and home/office document/media shredders		N/A
EE.1	General		N/A
EE.2	Markings and instructions		N/A
	Use of markings or symbols.....		N/A



EN 60950-1			
Clause	Requirement + Test	Result - Remark	Verdict

	Information of user instructions, maintenance and/or servicing instructions.....:		N/A
EE.3	Inadvertent reactivation test.....:		N/A
EE.4	Disconnection of power to hazardous moving parts:		N/A
	Use of markings or symbols.....:		N/A
EE.5	Protection against hazardous moving parts		N/A
	Test with test finger (Figure 2A)		N/A
	Test with wedge probe (Figure EE1 and EE2)		N/A



IEC 60950-1			
Clause	Requirement - Test	Result - Remark	Verdict

1.5.1	TABLE: List of critical components					Pass
object/part No.	manufacturer/ trademark	type/model	technical data	standard	mark(s) of conformity ¹⁾	
Power Adapter (optional)	Various	Various	O/P: 12Vdc, 1.0A Minimum. Marked with "LPS" or "Limited Power Source" or complied with "Limited Power Source" checked by inspection	IEC 60950-1 EN 60950-1	TUV, CE	
Power from AC source (optional)	Various	Various	O/P: 24Vac, 50- 60Hz, 0.9A Minimum, Marked with "LPS" or "Limited Power Source" or complied with "Limited Power Source" checked by inspection	IEC 60950-1 EN 60950-1	TUV, CE	
Metal Enclosure	--	--	Al, 3.0 mm thickness minimum, overall see Diagrams for detail.	--	--	
Lens cover	Various	Various	Glass	--	--	
PWB	--	--	V-1 or better, 105 °C	UL 796	UL	
Transformer of PoE Board (T1)	Coilcraft, Inc.	POE13F-12L	105 °C. See Enclosure 4-01	--	--	
Alternate of transformer of PoE Board (T1)	Acroparts Technology Co., Ltd.	POE13F-12L (13W12V)	105 °C. See Enclosure 4-01	--	--	
O-ring (for front and rear cover)	MING YEE INDUSTRIAL CO., LTD.	610024400G	EPDM rubber, overall see Diagrams for detail.	--	--	
Liquid-tight rubber washer (for power in)	AVC Industrial Corp.	P-WS-M12-A- SW	HB min., 80 degree C	--	--	



IEC60950_1B - ATTACHMENT			
Clause	Requirement + Test	Result - Remark	Verdict

1.5.1	TABLE: List of critical components					Pass
object/part No.	manufacturer/ trademark	type/model	technical data	standard	mark(s) of conformity ¹⁾	
Liquid-tight rubber washer (for General I/O Terminal)	AVC Industrial Corp.	P-WS-M16-A- SW	HB min., 80 degree C	--	--	
Liquid-tight flexible cord connectors (for General I/O Terminal)(optio nal)	AVC Industrial Corp.	MG16A- 2H2.8C- 6H2.0B-ST- SPM-XA	HB min., 80 degree C	--	--	
Liquid-tight plug (for General I/O Terminal)(optio nal)	AVC Industrial Corp.	SPG-M16-G	HB min., 80 degree C	--	--	
Supplementary information:						

1.5.1	TABLE: Opto Electronic Devices		N/A
Manufacturer			
Type.....			
Separately tested.....			
Bridging insulation			
External creepage distance.....			
Internal creepage distance			
Distance through insulation			
Tested under the following conditions			
Input.....			
Output.....			
supplementary information			



IEC60950_1B - ATTACHMENT

Clause	Requirement + Test	Result - Remark	Verdict
--------	--------------------	-----------------	---------

1.6.2	TABLE: Electrical data (in normal conditions)						Pass
U(V)/f(Hz)	I (A)	Irated (A)	P (W)	Fuse #	Ifuse (A)	Condition/status	
For Model: IP8352							
12 Vdc	0.88	1	10.56	--	--	Maximum normal load	
48 Vdc	0.29	0.35	16.80	--	--	Maximum normal load	
24 Vac 50HZ	0.82	0.90	15.69	--	--	Maximum normal load	
24 Vac 60HZ	0.83	0.90	15.71	--	--	Maximum normal load	
Note: Unit transmit video signal from RJ-45 connected to the computer, general I/O terminal output 12Vdc, loaded 0.4A.and working continuously.							

2.10.2	Table Hazardous Voltage (Circuit) Measurement			Pass
Clearance (cl) and creepage distance (cr) at/of/between:	Up (V)	U r.m.s. (V)	Limiting component	
D4 pin3-GND	--	12.8	--	
C2 pin1-GND	--	49.6	--	
C3 pin1-GND	--	49.6	--	
D3 pin2-GND	--	100	--	
T1 pin1,2-GND	--	48.8	--	
T1 pin7,8-GND	17.6	--	--	
T1 pin11,12-GND	104	--	--	
T1 pin3-GND	--	1.5	--	
T1 pin10-GND	22.0	--	--	
U2 pin3-1	--	8.0	--	
U2 pin3-2	--	7.2	--	
U2 pin4-1	--	8.8	--	
U2 pin4-2	--	7.2	--	
C1 pin2-GND	--	27.2	--	
D1 pin2-GND	--	11.0	--	
Q1 pin1,2-GND	12.8	--	--	
Q1 pin4-GND	--	1.4	--	
C17 Pin1-Pin2	--	1.2	--	
Note(s): T1 Pin5,6 was connected to earth.				

2.2.3	TABLE: SELV Reliability Test						Pass
No. Accessible Part From - To	Component No. (Voltage Limiting)	Fault	Test Voltage	Test time (Duration)	Fuse No.	Fuse Current (A)	Result Specify Maximum Vpk or V dc
Output connect	C4	short	48Vdc	30min	--	--	2.6Vdc
Output connect	Q1 pin1-	short	48Vdc	30min	--	--	1.2Vdc



IEC60950_1B - ATTACHMENT

Clause	Requirement + Test	Result - Remark	Verdict
--------	--------------------	-----------------	---------

Output connect	pin4 Q1 pin1- pin5	short	48Vdc	30min	--	--	1.2Vdc
Output connect	T1 Pin11,12- GND	short	48Vdc	30min	--	--	2.6Vdc

Note(s):--

2.5 **TABLE: limited power source measurements** Pass

output tested	measured		single fault condition	measured value (maximum)		
	from	to		Uoc	Isc	VA
Inherently limited						
For 48Vdc	--	--	--	--	--	--
DC Terminal Pin 3	V+	V-	--	6.35	0.01	0.01
DC Terminal Pin 8	V+	V-	--	2.53	0.01	0.01
DC Terminal Pin 2,5-7,9,10			0	--	--	0
For 12Vdc	--	--	--	--	--	--
RJ-45 All pins	V+	V-	--	0	--	--

Note :

1. $0.723V \times 0.01A = 0.01VA$
2. $0.517V \times 0.01A = 0.01VA$

4.5 **TABLE: Temperature rise measurements** Pass

	test voltage (V)	See below				---
	t _{amb1} (°C)	--				---
	t _{amb2} (°C)	--				---
maximum temperature T of part/at::		T (°C)				allowed T _{max} (°C)
--		Maximum Normal Load at 12Vdc, 60 Hz	Maximum Normal Load at 12Vdc, 60 Hz (Shift to Tma 50 degree C)	Maximum Normal POE Load at 48Vdc, 60 Hz	Maximum Normal POE Load at 48 Vdc, 60 Hz (Shift to Tma 50 degree C)	--
1. Ambient		26.4	50.0	27.4	50.0	--
2. T1 core		40.0	63.6	52.1	74.7	105
3. T1 coil		40.2	63.8	52.3	74.9	105
4. L17 coil		43.4	67.0	52.8	75.4	105
5. C57 body		41.6	65.2	51.0	73.6	105



IEC60950_1B - ATTACHMENT					
Clause	Requirement + Test		Result - Remark		Verdict
6. PWB near U7	43.2	66.8	67.9	90.5	105
7. BT1 body (for Reference only)	40.5	64.1	53.1	75.7	--
8.DC Terminal	39.0	62.6	47.3	69.9	95
9. T1 coil (POE Module)	41.4	65.0	84.8	107.4	130
10. T1core (POE Module)	41.2	64.8	82.2	104.8	130
11. C8 body (POE Module)	41.6	65.2	69.2	91.8	105
12. U2 body (POE Module)	42.0	65.6	67.8	90.4	100
13. C17 body (POE Module)	43.6	67.2	77.3	99.9	105
14. PWB near U14	45.3	68.9	52.6	75.2	105
15. PWB near U1	48.4	72.0	55.5	78.1	105
16. L22 coil	48.4	72.0	55.5	78.1	105
17. L18 coil	40.4	64.0	47.7	70.3	105
18. PWB near U10	40.6	64.2	46.3	68.9	105
19. L1 coil	36.7	60.3	41.4	64.0	105
20. Metal Enclosure Near Top	35.6	59.2	40.2	62.8	70
Test duration :	2.9hrs	2.9hrs	2.7hrs	2.7hrs	--
--	Maximum Normal Ceiling - mount Load at 24Vac, 60 Hz	Maximum Normal Ceiling - mount Load at 24 Vac, 60 Hz (Shift to Tma 50 degree C)	Maximum Normal Wall mount Load at 24Vac, 60 Hz	Maximum Normal Wall mount Load at 24 Vac, 60 Hz (Shift to Tma 50 degree C)	--
1. Ambient	28.7	50.0	28.7	50.0	--
2. T1 core	56.5	77.8	61.0	82.3	105
3. T1 coil	57.0	78.3	62.0	83.3	105
4. L17 coil	63.1	84.4	68.4	89.7	105
5. C57 body	58.8	80.1	63.3	84.6	105
6. PWB near U7	68.3	89.6	74.6	95.9	105
7. BT1 body (for Reference only)	54.1	75.4	57.4	78.7	--
8. DC Terminal	53.5	74.8	58.4	79.7	95
9. T1 coil (POE Module)	85.4	106.7	84.6	105.9	130
10. T1core (POE Module)	83.1	104.4	81.5	102.8	130
11. C8 body (POE Module)	72.6	93.9	75.6	96.9	105
12. U2 body (POE Module)	69.6	90.9	73.6	94.9	100
13. C17 body (POE Module)	79.3	100.6	83.0	104.3	105
14. PWB near U14	54.0	75.3	57.5	78.8	105



IEC60950_1B - ATTACHMENT

Clause	Requirement + Test	Result - Remark				Verdict
--------	--------------------	-----------------	--	--	--	---------

15. PWB near U1	57.1	78.4	60.9	82.2	105
16. L22 coil	57.1	78.4	61.1	82.4	105
17. L18 coil	48.6	69.9	50.2	71.5	105
18. PWB near U10	46.9	68.2	49.1	70.4	105
19. L1 coil	41.9	63.2	44.7	66.0	105
20. Metal Enclosure Near Top	40.9	62.2	43.9	65.2	70
Test duration :	2.7hrs	2.7hrs	3.5hrs	3.5hrs	--

Supplementary information:

- The temperatures were measured under worst case normal mode defined in 1.2.2.1 and as described in sub-clause 1.6.2 and at voltages as described above.
- With a maximum ambient temperature of 50 °C
- All values for T (°C) are re-calculated from actual ambient which the actual ambient lower than manufacturer's specification ambient temperature.
- All values for T (°C) are without re-calculated from actual ambient which the actual ambient higher than manufacturer's specification ambient temperature.

Other component:

- Max. temp. of 105°C (Capacitor)
- Max. temp. of 105°C (PCB)

- when no class of insulation is given, min. insulation 105 °C assumed.

User accessible area:

- material is Metal: 70°C

4.6	TABLE: enclosure opening		N/A
Location	Size (mm)	Comments	
Note(s):			

5.1	TABLE: Touch current measurement			N/A
Measured between:	Measured (mA)	Limit (mA)	Comments/conditions	
supplementary information:				



IEC60950_1B - ATTACHMENT

Clause	Requirement + Test	Result - Remark	Verdict
--------	--------------------	-----------------	---------

5.2	TABLE: electric strength tests, impulse tests and voltage surge tests			N/A
Test voltage applied between:	Voltage shape (AC, DC, impulse, surge)	Test voltage (V)	Breakdown Yes / No	
Basic/supplementary:				
--	--	--	--	
Reinforced:				
--	--	--	--	
--	--	--	--	

5.3	TABLE: Fault condition tests						N/A
	ambient temperature (°C)				See below		---
	model/type of power supply				--		---
	manufacturer of power supply				--		---
	rated markings of power supply				--		---
component No.	fault	test voltage (V)	test time	fuse No.	fuse current (A)	result	
--	--	--	--	--	--	--	
supplementary information:							
(COMPONENT FAILURE TEST; ABNORMAL OPERATION TEST; TRANSFORMER ABNORMAL OPERATION TEST) Result Abbreviations: IP - Internal protection operated (list component). CD - Components damaged (list damaged components). NT - Tissue paper remained intact. CT - Constant Temperature Obtained.							



National Differences

EUROPEAN

* No National Differences Declared

** Only Group Difference



IEC60950_1B - ATTACHMENT			
Clause	Requirement - Test	Result - Remark	Verdict

ATTACHMENT TO TEST REPORT IEC 60950-1 EUROPEAN GROUP DIFFERENCES AND NATIONAL DIFFERENCES Information technology equipment – Safety – Part 1: General requirements			
Differences according to..... : EN 60950-1:2006/A11:2009/A1:2010			
Attachment Form No..... : EU_GD_IEC60950_1B			
Attachment Originator : SGS Fimko Ltd			
Master Attachment..... : Date (2010-04)			
Copyright © 2010 IEC System for Conformity Testing and Certification of Electrical Equipment (IECEE), Geneva, Switzerland. All rights reserved.			

EN 60950-1:2006/A11:2009/A1:2010 – CENELEC COMMON MODIFICATIONS
--

IEC 60950-1, GROUP DIFFERENCES (CENELEC common modifications EN)			
Clause	Requirement + Test	Result - Remark	Verdict
Contents	Add the following annexes: Annex ZA (normative) Normative references to international publications with their corresponding European publications Annex ZB (normative) Special national conditions		Pass
General	Delete all the “country” notes in the reference document (IEC 60950-1:2005) according to the following list: 1.4.8 Note 2 1.5.1 Note 2 & 3 1.5.7.1 Note 1.5.8 Note 2 1.5.9.4 Note 1.7.2.1 Note 4, 5 & 6 2.2.3 Note 2.2.4 Note 2.3.2 Note 2.3.2.1 Note 2 2.3.4 Note 2 2.6.3.3 Note 2 & 3 2.7.1 Note 2.10.3.2 Note 2 2.10.5.13 Note 3 3.2.1.1 Note 3.2.4 Note 3. 2.5.1 Note 2 4.3.6 Note 1 & 2 4.7 Note 4 4.7.2.2 Note 4.7.3.1 Note 2 5.1.7.1 Note 3 & 4 5.3.7 Note 1 6 Note 2 & 5 6.1.2.1 Note 2 6.1.2.2 Note 6.2.2 Note 6.2.2.1 Note 2 6.2.2.2 Note 7.1 Note 3 7.2 Note 7.3 Note 1 & 2 G.2.1 Note 2 Annex H Note 2		Pass
General (A1:2010)	Delete all the “country” notes in the reference document (IEC 60950-1:2005/A1:2010) according to the following list: 1.5.7.1 Note 6.1.2.1 Note 2 6.2.2.1 Note 2 EE.3 Note		N/A



IEC60950_1B - ATTACHMENT			
Clause	Requirement - Test	Result - Remark	Verdict

IEC 60950-1, GROUP DIFFERENCES (CENELEC common modifications EN)			
Clause	Requirement + Test	Result - Remark	Verdict
1.3.Z1	<p>Add the following subclause:</p> <p>1.3.Z1 Exposure to excessive sound pressure</p> <p>The apparatus shall be so designed and constructed as to present no danger when used for its intended purpose, either in normal operating conditions or under fault conditions, particularly providing protection against exposure to excessive sound pressures from headphones or earphones.</p> <p>NOTE Z1 A new method of measurement is described in EN 50332-1, Sound system equipment:</p> <p>Headphones and earphones associated with portable audio equipment - Maximum sound pressure level measurement methodology and limit considerations - Part 1: General method for "one package equipment", and in EN 50332-2, Sound system equipment: Headphones and earphones associated with portable audio equipment - Maximum sound pressure level measurement methodology and limit considerations - Part 2: Guidelines to associate sets with headphones coming from different manufacturers.</p>		N/A
1.5.1	<p>Add the following NOTE:</p> <p>NOTE Z1 The use of certain substances in electrical and electronic equipment is restricted within the EU: see Directive 2002/95/EC</p>		N/A
1.7.2.1 (A1:2010)	<p>In addition, for a PORTABLE SOUND SYSTEM, the instructions shall include a warning that excessive sound pressure from earphones and headphones can cause hearing loss.</p>		N/A
2.7.1	<p>Replace the subclause as follows:</p> <p>Basic requirements</p> <p>To protect against excessive current, short-circuits and earth faults in PRIMARY CIRCUITS, protective devices shall be included either as integral parts of the equipment or as parts of the building installation, subject to the following, a), b) and c):</p> <p>except as detailed in b) and c), protective devices necessary to comply with the requirements of 5.3 shall be included as parts of the equipment;</p> <p>b) for components in series with the mains input to the equipment such as the supply cord, appliance coupler, r.f.i. filter and switch, short-circuit and earth fault protection may be provided by protective devices in the building installation;</p>		Pass



IEC60950_1B - ATTACHMENT			
Clause	Requirement - Test	Result - Remark	Verdict

IEC 60950-1, GROUP DIFFERENCES (CENELEC common modifications EN)									
Clause	Requirement + Test	Result - Remark	Verdict						
	<p>c) it is permitted for PLUGGABLE EQUIPMENT TYPE B or PERMANENTLY CONNECTED EQUIPMENT, to rely on dedicated overcurrent and short-circuit protection in the building installation, provided that the means of protection, e.g. fuses or circuit breakers, is fully specified in the installation instructions.</p> <p>If reliance is placed on protection in the building installation, the installation instructions shall so state, except that for PLUGGABLE EQUIPMENT TYPE A the building installation shall be regarded as providing protection in accordance with the rating of the wall socket outlet.</p>								
2.7.2	This subclause has been declared 'void'.		N/A						
3.2.3	Delete the NOTE in Table 3A, and delete also in this table the conduit sizes in parentheses.		N/A						
3.2.5.1	<p>Replace "60245 IEC 53" by "H05 RR-F"; "60227 IEC 52" by "H03 VV-F or H03 VVH2-F"; "60227 IEC 53" by "H05 VV-F or H05 VVH2-F2".</p> <p>In Table 3B, replace the first four lines by the following:</p> <table border="0"> <tr> <td>Up to and including 6 </td> <td>0,75^{a)} </td> </tr> <tr> <td>Over 6 up to and including 10 </td> <td>(0,75)^{b)} 1,0 </td> </tr> <tr> <td>Over 10 up to and including 16 </td> <td>(1,0)^{c)} 1,5 </td> </tr> </table> <p>In the conditions applicable to Table 3B delete the words "in some countries" in condition^{a)}.</p> <p>In NOTE 1, applicable to Table 3B, delete the second sentence.</p>	Up to and including 6	0,75 ^{a)}	Over 6 up to and including 10	(0,75) ^{b)} 1,0	Over 10 up to and including 16	(1,0) ^{c)} 1,5		N/A
Up to and including 6	0,75 ^{a)}								
Over 6 up to and including 10	(0,75) ^{b)} 1,0								
Over 10 up to and including 16	(1,0) ^{c)} 1,5								
3.3.4	<p>In Table 3D, delete the fourth line: conductor sizes for 10 to 13 A, and replace with the following:</p> <table border="0"> <tr> <td>Over 10 up to and including 16 </td> <td>1,5 to 2,5 </td> <td>1,5 to 4 </td> </tr> </table> <p>Delete the fifth line: conductor sizes for 13 to 16 A</p>	Over 10 up to and including 16	1,5 to 2,5	1,5 to 4		N/A			
Over 10 up to and including 16	1,5 to 2,5	1,5 to 4							



IEC60950_1B - ATTACHMENT			
Clause	Requirement - Test	Result - Remark	Verdict

IEC 60950-1, GROUP DIFFERENCES (CENELEC common modifications EN)			
Clause	Requirement + Test	Result - Remark	Verdict
4.3.13.6 (A1:2010)	<p>Replace the existing NOTE by the following: NOTE Z1 Attention is drawn to:</p> <p>1999/519/EC: Council Recommendation on the limitation of exposure of the general public to electromagnetic fields 0 Hz to 300 GHz, and 2006/25/EC: Directive on the minimum health and safety requirements regarding the exposure of workers to risks arising from physical agents (artificial optical radiation).</p> <p>Standards taking into account mentioned Recommendation and Directive which demonstrate compliance with the applicable EU Directive are indicated in the OJEC.</p>		N/A
Annex H	<p>Replace the last paragraph of this annex by:</p> <p>At any point 10 cm from the surface of the OPERATOR ACCESS AREA, the dose rate shall not exceed 1 µSv/h (0,1 mR/h) (see NOTE). Account is taken of the background level.</p> <p>Replace the notes as follows: NOTE These values appear in Directive 96/29/Euratom. Delete NOTE 2.</p>		N/A
Bibliography	Additional EN standards.		—

ZA	NORMATIVE REFERENCES TO INTERNATIONAL PUBLICATIONS WITH THEIR CORRESPONDING EUROPEAN PUBLICATIONS		—
----	--	--	---

ZB ANNEX (normative) SPECIAL NATIONAL CONDITIONS (EN)			
Clause	Requirement + Test	Result - Remark	Verdict
1.2.4.1	In Denmark, certain types of Class I appliances (see 3.2.1.1) may be provided with a plug not establishing earthing conditions when inserted into Danish socket-outlets.		N/A
1.2.13.14	In Norway and Sweden, for requirements see 1.7.2.1 and 7.3 of this annex.		N/A
1.5.7.1	In Finland, Norway and Sweden, resistors bridging BASIC INSULATION in CLASS I PLUGGABLE EQUIPMENT TYPE A must comply with the requirements in 1.5.7.1. In addition when a single resistor is used, the resistor must withstand the resistor test in 1.5.7.2.		N/A



IEC60950_1B - ATTACHMENT			
Clause	Requirement - Test	Result - Remark	Verdict

ZB ANNEX (normative) SPECIAL NATIONAL CONDITIONS (EN)			
Clause	Requirement + Test	Result - Remark	Verdict
1.5.8	In Norway, due to the IT power system used (see annex V, Figure V.7), capacitors are required to be rated for the applicable line-to-line voltage (230 V).		N/A
1.5.9.4	In Finland, Norway and Sweden, the third dashed sentence is applicable only to equipment as defined in 6.1.2.2 of this annex.		N/A
1.7.2.1	<p>In Finland, Norway and Sweden, CLASS I PLUGGABLE EQUIPMENT TYPE A intended for connection to other equipment or a network shall, if safety relies on connection to protective earth or if surge suppressors are connected between the network terminals and accessible parts, have a marking stating that the equipment must be connected to an earthed mains socket-outlet.</p> <p>The marking text in the applicable countries shall be as follows:</p> <p>In Finland: "Laite on liitettävä suojakoskettimilla varustettuun pistorasiaan"</p> <p>In Norway: "Apparatet må tilkoples jordet stikkontakt"</p> <p>In Sweden: "Apparaten skall anslutas till jordat uttag"</p> <p>In Norway and Sweden, the screen of the cable distribution system is normally not earthed at the entrance of the building and there is normally no equipotential bonding system within the building. Therefore the protective earthing of the building installation need to be isolated from the screen of a cable distribution system.</p> <p>It is however accepted to provide the insulation external to the equipment by an adapter or an interconnection cable with galvanic isolator, which may be provided by e.g. a retailer.</p>		N/A



IEC60950_1B - ATTACHMENT			
Clause	Requirement - Test	Result - Remark	Verdict

ZB ANNEX (normative) SPECIAL NATIONAL CONDITIONS (EN)			
Clause	Requirement + Test	Result - Remark	Verdict
	<p>The user manual shall then have the following or similar information in Norwegian and Swedish language respectively, depending on in what country the equipment is intended to be used in:</p> <p>“Equipment connected to the protective earthing of the building installation through the mains connection or through other equipment with a connection to protective earthing – and to a cable distribution system using coaxial cable, may in some circumstances create a fire hazard. Connection to a cable distribution system has therefore to be provided through a device providing electrical isolation below a certain frequency range (galvanic isolator, see EN 60728-11).”</p> <p>NOTE In Norway, due to regulation for installations of cable distribution systems, and in Sweden, a galvanic isolator shall provide electrical insulation below 5 MHz. The insulation shall withstand a dielectric strength of 1,5 kV r.m.s., 50 Hz or 60 Hz, for 1 min.</p> <p>Translation to Norwegian (the Swedish text will also be accepted in Norway):</p> <p>“Utstyr som er koplet til beskyttelsesjord via nettplugg og/eller via annet jordtilkoplet utstyr – og er tilkoplet et kabel-TV nett, kan forårsake brannfare. For å unngå dette skal det ved tilkopling av utstyret til kabel-TV nettet installeres en galvanisk isolator mellom utstyret og kabel- TV nettet.”</p> <p>Translation to Swedish:</p> <p>”Utrustning som är kopplad till skyddsjord via jordat vägguttag och/eller via annan utrustning och samtidigt är kopplad till kabel-TV nät kan i vissa fall medföra risk för brand. För att undvika detta skall vid anslutning av utrustningen till kabel-TV nät galvanisk isolator finnas mellan utrustningen och kabel-TV nätet.”</p>		N/A



IEC60950_1B - ATTACHMENT			
Clause	Requirement - Test	Result - Remark	Verdict

ZB ANNEX (normative) SPECIAL NATIONAL CONDITIONS (EN)			
Clause	Requirement + Test	Result - Remark	Verdict
	SEV 6533-2.1991 Plug Type 11 L+N 250 V, 10 A SEV 6534-2.1991 Plug Type 12 L+N+PE 250 V, 10 A In general, EN 60309 applies for plugs for currents exceeding 10 A. However, a 16 A plug and socket-outlet system is being introduced in Switzerland, the plugs of which are according to the following dimension sheets, published in February 1998: SEV 5932-2.1998: Plug Type 25 , 3L+N+PE 230/400 V, 16 A SEV 5933-2.1998: Plug Type 21, L+N, 250 V, 16A SEV 5934-2.1998: Plug Type 23, L+N+PE 250 V,		N/A
3.2.1.1	In Denmark, supply cords of single-phase equipment having a rated current not exceeding 13 A shall be provided with a plug according to the Heavy Current Regulations, Section 107-2-D1. CLASS I EQUIPMENT provided with socket-outlets with earth contacts or which are intended to be used in locations where protection against indirect contact is required according to the wiring rules shall be provided with a plug in accordance with standard sheet DK 2-1a or DK 2-5a. If poly-phase equipment and single-phase equipment having a RATED CURRENT exceeding 13 A is provided with a supply cord with a plug, this plug shall be in accordance with the Heavy Current Regulations, Section 107-2-D1 or EN 60309-2.		N/A



IEC60950_1B - ATTACHMENT			
Clause	Requirement - Test	Result - Remark	Verdict

ZB ANNEX (normative) SPECIAL NATIONAL CONDITIONS (EN)			
Clause	Requirement + Test	Result - Remark	Verdict
3.2.1.1	<p>In Spain, supply cords of single-phase equipment having a rated current not exceeding 10 A shall be provided with a plug according to UNE 20315:1994.</p> <p>Supply cords of single-phase equipment having a rated current not exceeding 2,5 A shall be provided with a plug according to UNE-EN 50075:1993.</p> <p>CLASS I EQUIPMENT provided with socket-outlets with earth contacts or which are intended to be used in locations where protection against indirect contact is required according to the wiring rules, shall be provided with a plug in accordance with standard UNE 20315:1994.</p> <p>If poly-phase equipment is provided with a supply cord with a plug, this plug shall be in accordance with UNE-EN 60309-2.</p>		N/A
3.2.1.1	<p>In the United Kingdom, apparatus which is fitted with a flexible cable or cord and is designed to be connected to a mains socket conforming to BS 1363 by means of that flexible cable or cord and plug, shall be fitted with a 'standard plug' in accordance with Statutory Instrument 1768:1994 - The Plugs and Sockets etc. (Safety) Regulations 1994, unless exempted by those regulations.</p> <p>NOTE 'Standard plug' is defined in SI 1768:1994 and essentially means an approved plug conforming to BS 1363 or an approved conversion plug.</p>		N/A
3.2.1.1	<p>In Ireland, apparatus which is fitted with a flexible cable or cord and is designed to be connected to a mains socket conforming to I.S. 411 by means of that flexible cable or cord and plug, shall be fitted with a 13 A plug in accordance with Statutory Instrument 525:1997 - National Standards Authority of Ireland (section 28) (13 A Plugs and Conversion Adaptors for Domestic Use) Regulations 1997.</p>		N/A
3.2.4	<p>In Switzerland, for requirements see 3.2.1.1 of this annex.</p>		N/A
3.2.5.1	<p>In the United Kingdom, a power supply cord with conductor of 1,25 mm² is allowed for equipment with a rated current over 10 A and up to and including 13 A.</p>		N/A



IEC60950_1B - ATTACHMENT			
Clause	Requirement - Test	Result - Remark	Verdict

ZB ANNEX (normative) SPECIAL NATIONAL CONDITIONS (EN)			
Clause	Requirement + Test	Result - Remark	Verdict
3.3.4	<p>In the United Kingdom, the range of conductor sizes of flexible cords to be accepted by terminals for equipment with a RATED CURRENT of over 10 A up to and including 13 A is:</p> <ul style="list-style-type: none"> • 1,25 mm² to 1,5 mm² nominal cross-sectional area. 		N/A
4.3.6	<p>In the United Kingdom, the torque test is performed using a socket outlet complying with BS 1363 part 1:1995, including Amendment 1:1997 and Amendment 2:2003 and the plug part of DIRECT PLUG-IN EQUIPMENT shall be assessed to BS 1363: Part 1, 12.1, 12.2, 12.3, 12.9, 12.11, 12.12, 12.13, 12.16 and 12.17, except that the test of 12.17 is performed at not less than 125 °C. Where the metal earth pin is replaced by an Insulated Shutter Opening Device (ISOD), the requirements of clauses 22.2 and 23 also apply.</p>		N/A
4.3.6	<p>In Ireland, DIRECT PLUG-IN EQUIPMENT is known as plug similar devices. Such devices shall comply with Statutory Instrument 526:1997 - National Standards Authority of Ireland (Section 28) (Electrical plugs, plug similar devices and sockets for domestic use) Regulations, 1997.</p>		N/A
5.1.7.1	<p>In Finland, Norway and Sweden TOUCH CURRENT measurement results exceeding 3,5 mA r.m.s. are permitted only for the following equipment:</p> <ul style="list-style-type: none"> • STATIONARY PLUGGABLE EQUIPMENT TYPE A that <ul style="list-style-type: none"> is intended to be used in a RESTRICTED ACCESS LOCATION where equipotential bonding has been applied, for example, in a telecommunication centre; and has provision for a permanently connected PROTECTIVE EARTHING CONDUCTOR; and is provided with instructions for the installation of that conductor by a SERVICE PERSON; • STATIONARY PLUGGABLE EQUIPMENT TYPE B; • STATIONARY PERMANENTLY CONNECTED EQUIPMENT. 		N/A



IEC60950_1B - ATTACHMENT			
Clause	Requirement - Test	Result - Remark	Verdict

ZB ANNEX (normative) SPECIAL NATIONAL CONDITIONS (EN)			
Clause	Requirement + Test	Result - Remark	Verdict
6.1.2.1 (A1:2010)	<p>In Finland, Norway and Sweden, add the following text between the first and second paragraph of the compliance clause:</p> <p>If this insulation is solid, including insulation forming part of a component, it shall at least consist of either</p> <ul style="list-style-type: none"> - two layers of thin sheet material, each of which shall pass the electric strength test below, or - one layer having a distance through insulation of at least 0,4 mm, which shall pass the electric strength test below. <p>Alternatively for components, there is no distance through insulation requirements for the insulation consisting of an insulating compound completely filling the casing, so that CLEARANCES and CREEPAGE DISTANCES do not exist, if the component passes the electric strength test in accordance with the compliance clause below and in addition</p> <ul style="list-style-type: none"> - passes the tests and inspection criteria of 2.10.11 with an electric strength test of 1,5 kV multiplied by 1,6 (the electric strength test of 2.10.10 shall be performed using 1,5 kV), and - is subject to ROUTINE TESTING for electric strength during manufacturing, using a test voltage of 1,5 kV. <p>It is permitted to bridge this insulation with an optocoupler complying with 2.10.5.4 b).</p> <p>It is permitted to bridge this insulation with a capacitor complying with EN 60384-14:2005, subclass Y2.</p>		N/A



IEC60950_1B - ATTACHMENT			
Clause	Requirement - Test	Result - Remark	Verdict

ZB ANNEX (normative) SPECIAL NATIONAL CONDITIONS (EN)			
Clause	Requirement + Test	Result - Remark	Verdict
	<p>A capacitor classified Y3 according to EN 60384-14:2005, may bridge this insulation under the following conditions:</p> <ul style="list-style-type: none"> - the insulation requirements are satisfied by having a capacitor classified Y3 as defined by EN 60384-14, which in addition to the Y3 testing, is tested with an impulse test of 2,5 kV defined in EN 60950-1:2006, 6.2.2.1; - the additional testing shall be performed on all the test specimens as described in EN 60384-14; - the impulse test of 2,5 kV is to be performed before the endurance test in EN 60384-14, in the sequence of tests as described in EN 60384-14. 		N/A
6.1.2.2	<p>In Finland, Norway and Sweden, the exclusions are applicable for PERMANENTLY CONNECTED EQUIPMENT, PLUGGABLE EQUIPMENT TYPE B and equipment intended to be used in a RESTRICTED ACCESS LOCATION where equipotential bonding has been applied, e.g. in a telecommunication centre, and which has provision for a permanently connected PROTECTIVE EARTHING CONDUCTOR and is provided with instructions for the installation of that conductor by a SERVICE PERSON.</p>		N/A
7.2	<p>In Finland, Norway and Sweden, for requirements see 6.1.2.1 and 6.1.2.2 of this annex.</p> <p>The term TELECOMMUNICATION NETWORK in 6.1.2 being replaced by the term CABLE DISTRIBUTION SYSTEM.</p>		N/A
7.3	<p>In Norway and Sweden, for requirements see 1.2.13.14 and 1.7.2.1 of this annex.</p>		N/A
7.3	<p>In Norway, for installation conditions see EN 60728-11:2005.</p>		N/A



Enclosures

<u>Type</u>	<u>Supplement Id</u>	<u>Description</u>
Marking Plate	13-01	Labels
Photographs	3-01	Overall view1
Photographs	3-02	Overall View 2
Photographs	3-03	Overall view with stand
Photographs	3-04	Internal view
Photographs	3-05	Len module top side view
Photographs	3-06	Len module bottom side view
Photographs	3-07	mainboard top side view
Photographs	3-08	mainboard bottom side view
Photographs	3-09	IO board top side view
Photographs	3-10	IO board bottom side view
Diagrams	4-01	Enclosure Drawing
Schematics + PWB		
Manuals		
Miscellaneous	7-01	LETTER REPORT FOR IP67 EVALUATION ON NETWORK CAMERA



Marking Plate ID 13-01





Photographs ID 3-01 Overall view1



Photographs ID 3-02 Overall view2

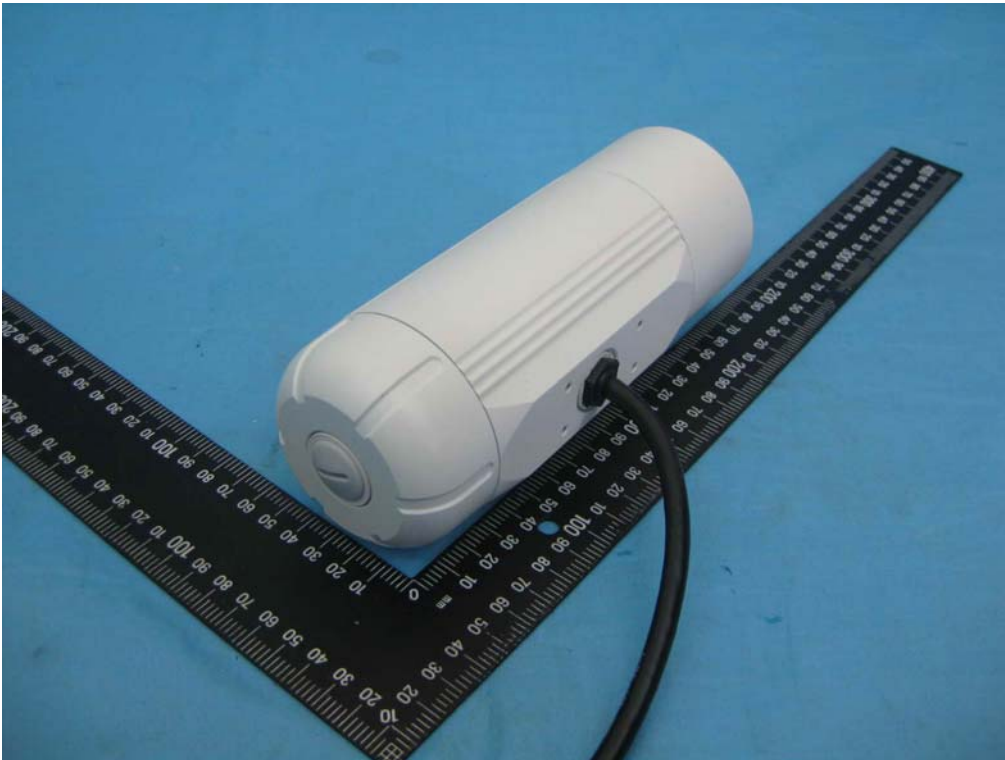



Photographs ID 3-03 Overall view with stand



Photographs ID 3-04 Internal view

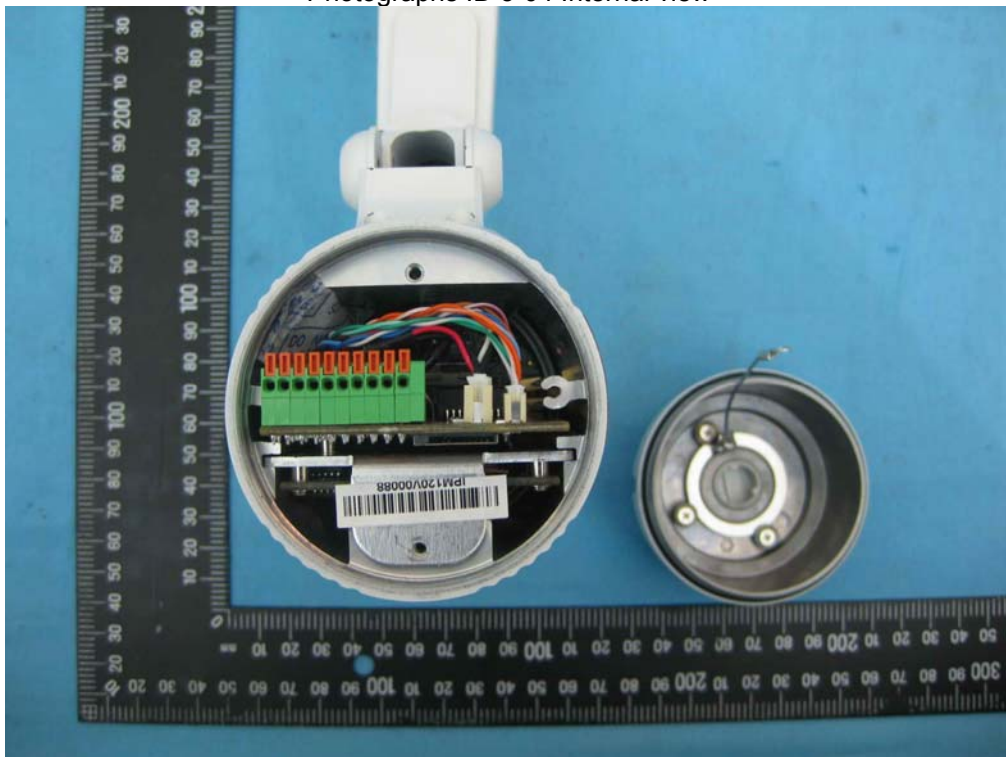



Photographs ID 3-05 Len module top side view

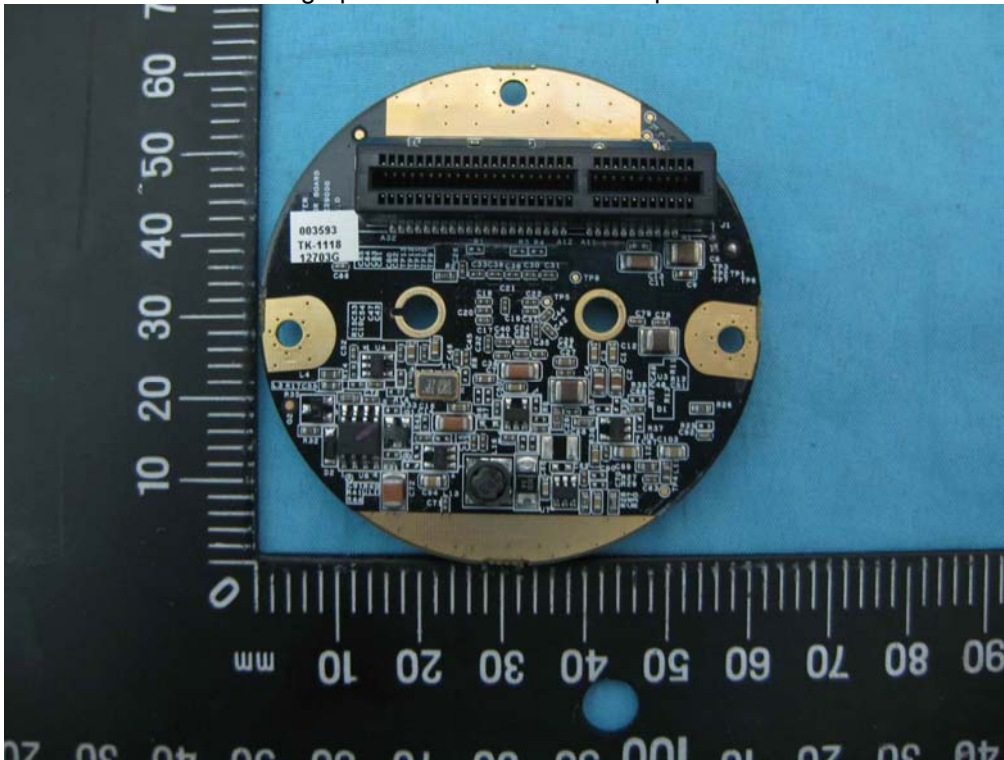

Photographs ID 3-06 Len module bottom side view

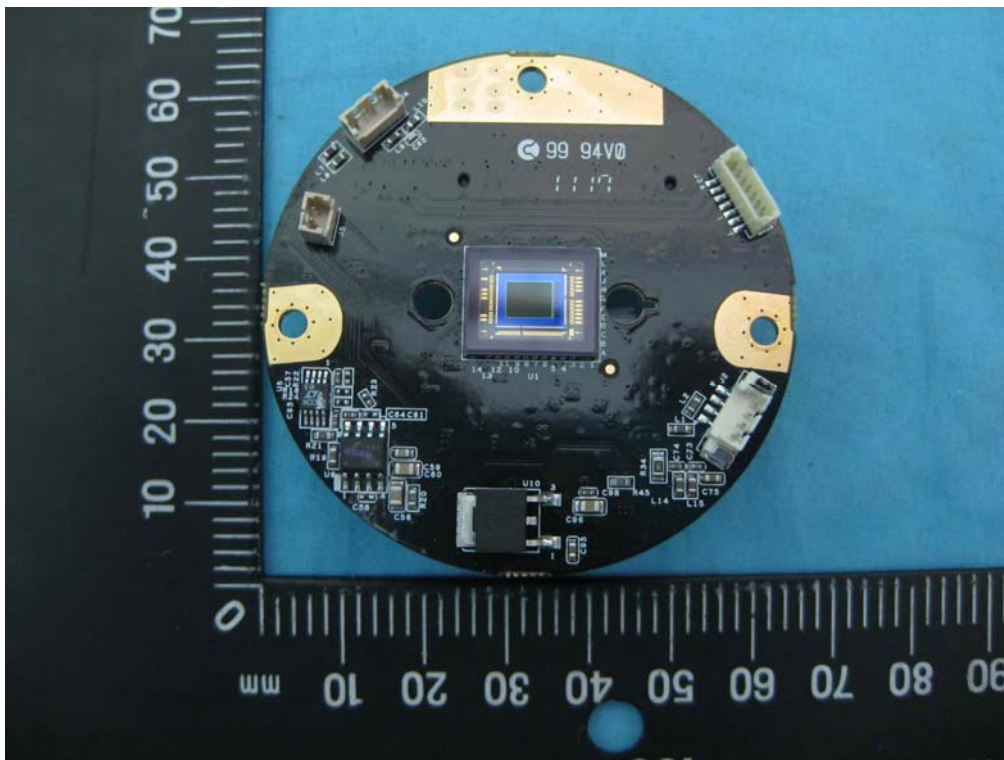



Photographs ID 3-07 mainboard top side view

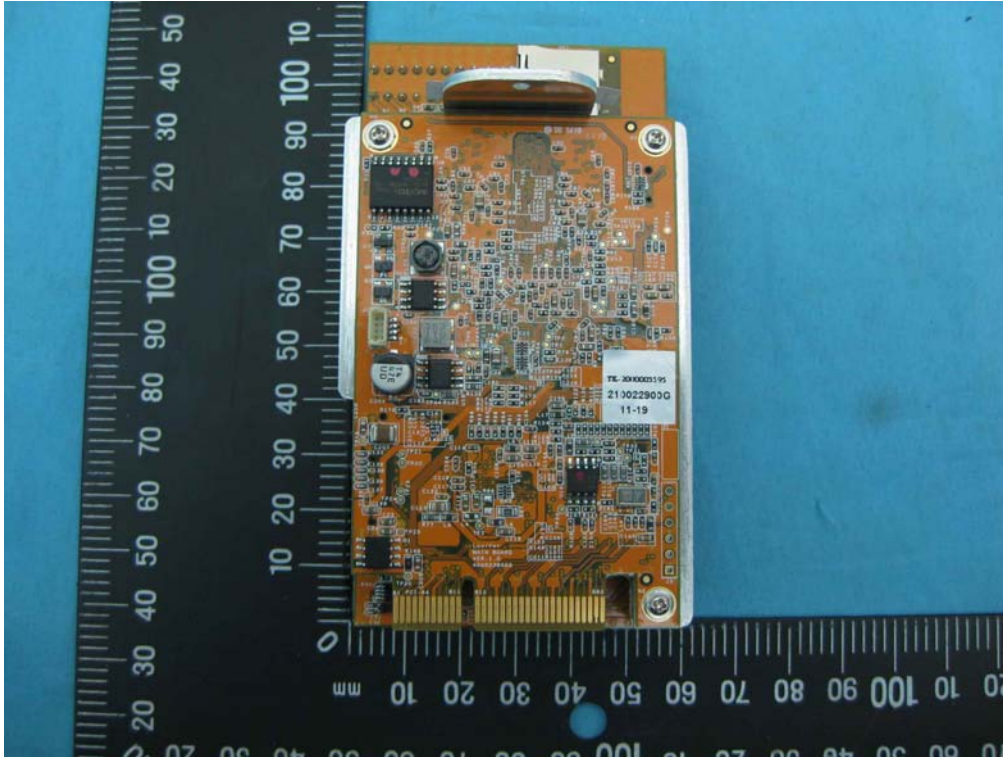

Photographs ID 3-08 mainboard bottom side view

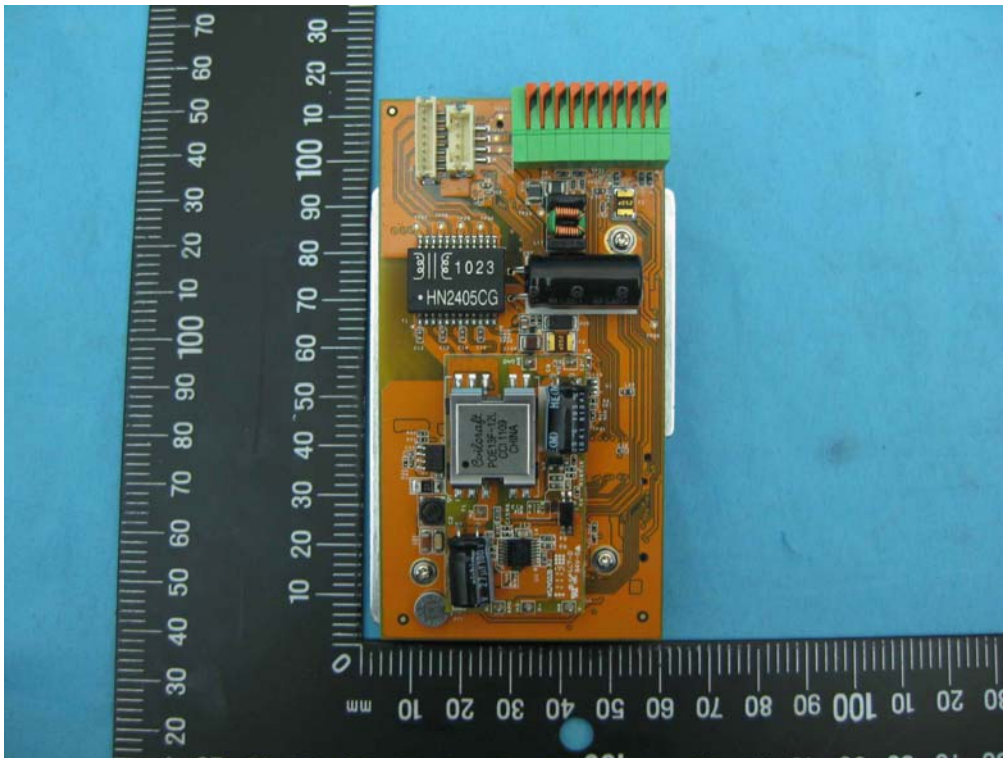



Photographs ID 3-09 IO board top side view

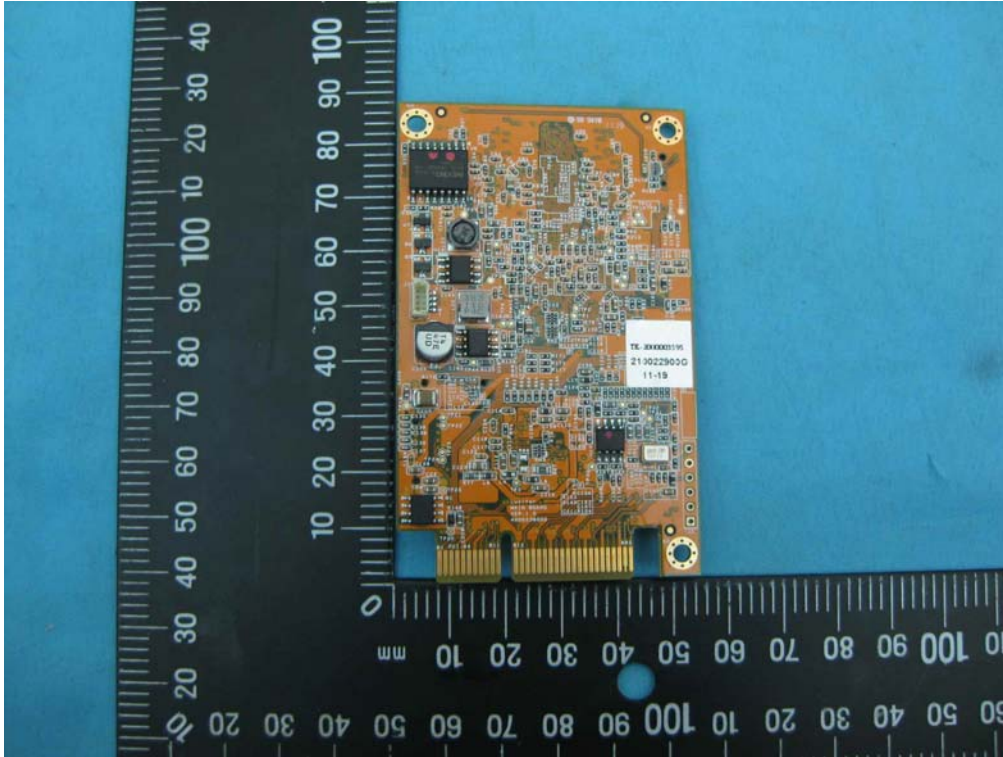

Photographs ID 3-10 IO board bottom side view

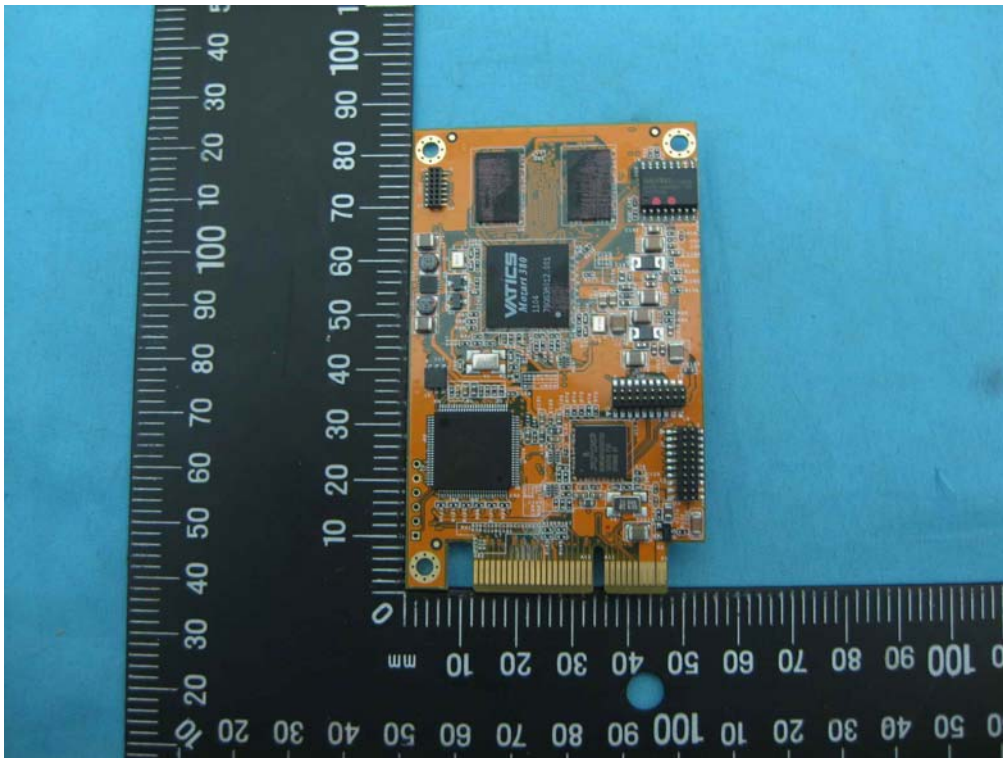



Diagrams ID 4-01

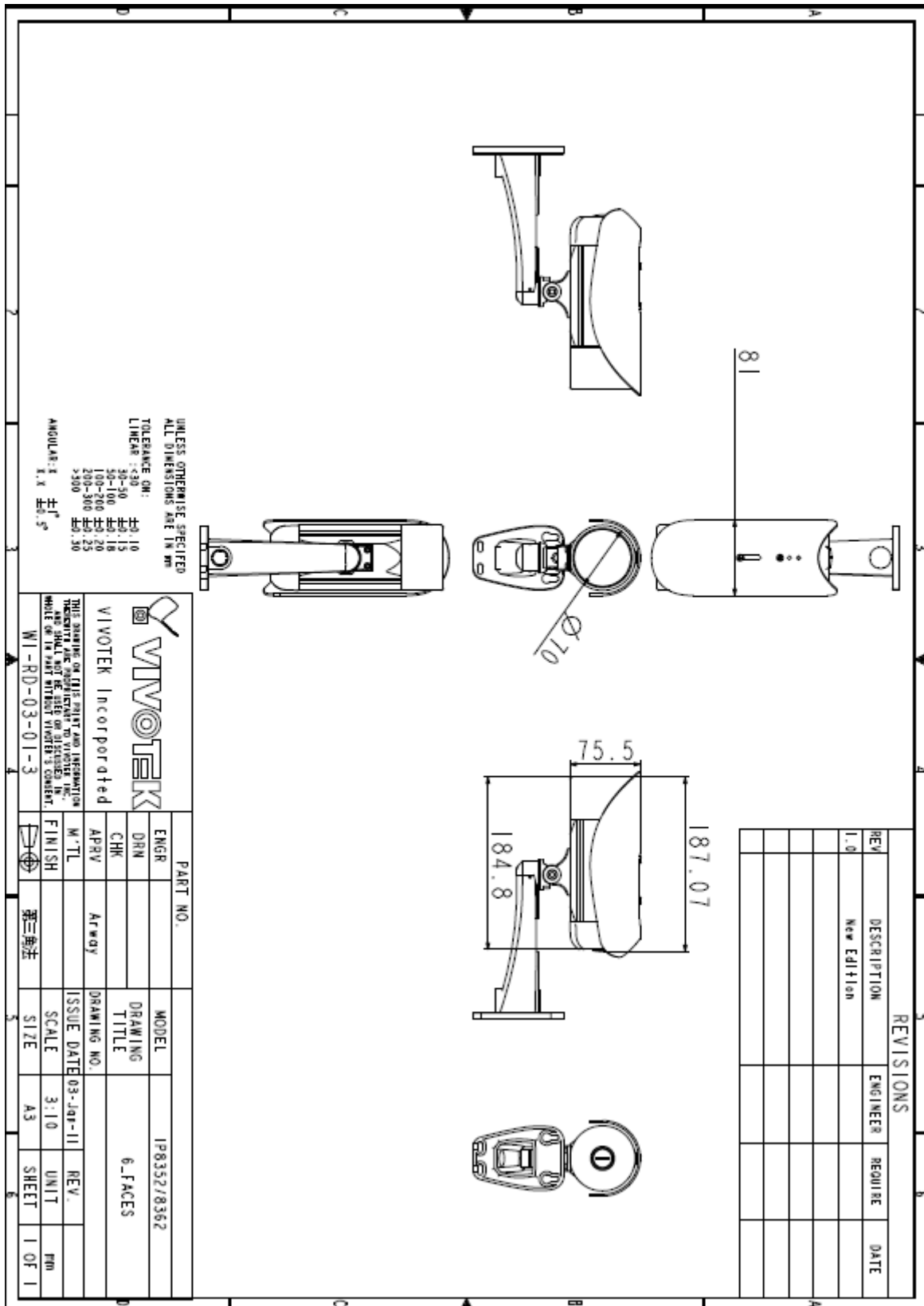



Diagrams ID 4-01

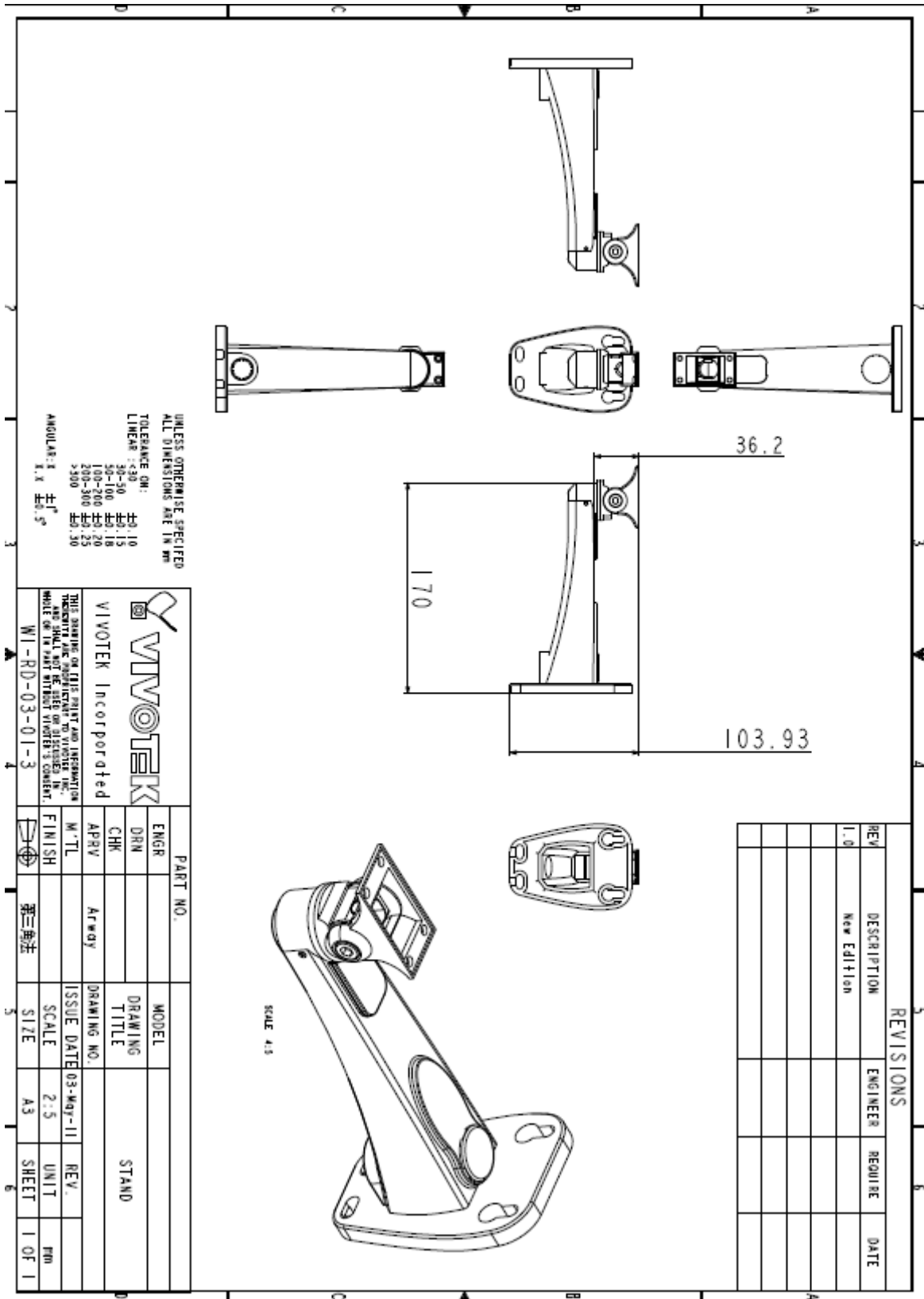



the standard in safety

Underwriters
Laboratories

August 03, 2011

E324690
11CA32314

1 of 2

To Customer

Reference: File E324690 Project 11CA32314
Subject: LETTER REPORT FOR IP67 EVALUATION ON NETWORK CAMERA, MODELS IP8352,
IP8362

Dear Customer,

We have completed our investigation, and this letter will serve as our report. For the file record, our evaluation only covers the applicable tests needed for IP67 in accordance with the requirements of IEC 60529, Degrees of Protection provided by enclosures, 2.1 Ed, Revision Date October 2009.

Samples of Model IP8352 were tested. The enclosure of Model IP8362 is identical to Model IP8352. The following table details the models tested, the test, the standard clauses, and the results.

Models	Test	Standard Clause	Results
NETWORK CAMERA, MODEL IP8352	IP 6X	IEC 60529, Edition 2.1, Revision Date October 2009, CLAUSE 12	Since this device doesn't have any openings on the enclosure, this test was not considered necessary.
	IP 6X	IEC 60529, Edition 2.1, Revision Date October 2009, CLAUSE 13	Compliance
	IP X7	IEC 60529, Edition 2.1, Revision Date October 2009, CLAUSE 14	Compliance



the standard in safety

Underwriters
Laboratories

August 03, 2011

E324690
11CA32314

2 of 2

Should you have any questions or comments concerning the above, please feel free to contact me.

Sincerely,

Cloud Chen
Associate Project Engineer
Conformity Assessment Services, 3012CTAI

Reviewed by:

William Bartunek
Senior Staff Engineer
Conformity Assessment Services

Paul Chen
Project Engineer
Conformity Assessment Services, 3012CTAI