



## Test Report

Product Name : Outdoor Bullet Network Camera

Model No. : IP8362

Applicant : VIVOTEK INC.

Address : 6F, No.192, Lien-Cheng Rd., Chung-Ho,  
New Taipei City, 235, Taiwan, R.O.C.

Date of Receipt : 2011/03/01

Issued Date : 2011/04/19

Report No. : 113017R-ITCEP11V03

Report Version : V1.0

The test results relate only to the samples tested.

The test results shown in the test report are traceable to the national/international standard through the calibration of the equipment and evaluated measurement uncertainty herein.

This report must not be used to claim product endorsement by TAF, NVLAP or any agency of the Government.

The test report shall not be reproduced except in full without the written approval of QuieTek Corporation.



# Declaration of Conformity

We herewith confirm the following designated products to comply with the requirements set out in the Council Directive on the approximation of the laws of the Member States relating to Electromagnetic Compatibility Directive (2004/108/EC) with applicable standards listed below.

Product : Outdoor Bullet Network Camera  
Trade name : VIVOTEK  
Model Number : IP8362  
Applicable Harmonized : EN 55022: 2006+A1: 2007, Class A  
Standards under Directive EN 55024: 1998+A1: 2001+A2: 2003  
2004/108/EC EN 61000-3-2:2006+A2: 2009  
EN 61000-3-3:2008

Company Name : \_\_\_\_\_  
Company Address : \_\_\_\_\_  
Telephone : \_\_\_\_\_ Facsimile : \_\_\_\_\_

Person in responsible for marking this declaration:

_____ Name (Full Name)	_____ Title/ Department
_____ Date	_____ Legal Signature



## Statement of Conformity

This statement is to certify that the designated product below.

Product : Outdoor Bullet Network Camera  
Trade name : VIVOTEK  
Model Number : IP8362  
Company Name : VIVOTEK INC.  
Applicable Standards : EN 55022: 2006+A1: 2007, Class A  
EN 55024: 1998+A1: 2001+A2: 2003  
EN 61000-3-2:2006+A2: 2009  
EN 61000-3-3:2008

One sample of the designated product has been tested and evaluated in our laboratory to find in compliance with the applicable standards above. The issued test report(s) show(s) it in detail.

Report Number : 113017R-ITCEP11V03



The verification is based on a single evaluation of one sample of above-mentioned products. It does not imply an assessment of the whole production and does not permit the use of the test lab. Logo.

# Test Report Certification

Issued Date : 2011/04/19  
Report No. : 113017R-ITCEP11V03



Product Name : Outdoor Bullet Network Camera

Applicant : VIVOTEK INC.

Address : 6F, No.192, Lien-Cheng Rd., Chung-Ho, New Taipei City, 235,  
Taiwan, R.O.C.

Manufacturer : VIVOTEK INC.

Model No. : IP8362

EUT Rated Voltage : AC 100-240V, 50-60Hz

EUT Test Voltage : AC 230V / 50Hz

Trade Name : VIVOTEK

Applicable Standard : EN 55022: 2006+A1: 2007, Class A  
EN 55024: 1998+A1: 2001+A2: 2003  
EN 61000-3-2:2006+A2: 2009  
EN 61000-3-3:2008  
AS/NZS CISPR 22: 2009

Test Result : Complied

Performed Location : Quietek Corporation (Linkou Laboratory)  
No. 5-22, Rueishu Keng, Linkou Dist., New Taipei City 24451,  
Taiwan. R.O.C.  
TEL:+866-2-8601-3788 / FAX:+886-2-8601-3789

Documented By :   
( Adm. Specialist / Joanne Lin )

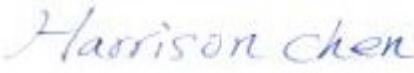
Reviewed By :   
( Engineer / Harrison Chen )

Approved By :   
( Manager / Vincent Lin )

## Laboratory Information

We, **Quietek Corporation**, are an independent EMC and safety consultancy that was established the whole facility in our laboratories. The test facility has been accredited/accepted (audited or listed) by the following related bodies in compliance with ISO 17025, EN 45001 and specified testing scopes:

<b>Taiwan R.O.C.</b>	<b>:</b>	<b>BSMI, NCC, TAF</b>
<b>Germany</b>	<b>:</b>	<b>TUV Rheinland</b>
<b>Norway</b>	<b>:</b>	<b>Nemko, DNV</b>
<b>USA</b>	<b>:</b>	<b>FCC, NVLAP</b>
<b>Japan</b>	<b>:</b>	<b>VCCI</b>

The related certificate for our laboratories about the test site and management system can be downloaded from Quietek Corporation's Web Site : <http://www.quietek.com/tw/ctg/cts/accreditations.htm>  
 The address and introduction of Quietek Corporation's laboratories can be founded in our Web site : <http://www.quietek.com/>

If you have any comments, Please don't hesitate to contact us. Our contact information is as below:

### HsinChu Testing Laboratory :

No.75-2, 3rd Lin, Wangye Keng, Yonghxing Tsuen, Qionglin Shiang, Hsinchu County 307, Taiwan, R.O.C.

TEL:+886-3-592-8858 / FAX:+886-3-592-8859 E-Mail : [service@quietek.com](mailto:service@quietek.com)



### LinKou Testing Laboratory :

No. 5-22, Rueishu Keng, Linkou Dist., New Taipei City 24451, Taiwan. R.O.C

TEL : 886-2-8601-3788 / FAX : 886-2-8601-3789 E-Mail : [service@quietek.com](mailto:service@quietek.com)



### Suzhou (China) Testing Laboratory :

No. 99 Hongye Rd., Suzhou Industrial Park Loufeng Hi-Tech Development Zone., Suzhou,China.

TEL : +86-512-6251-5088 / FAX : +86-512-6251-5098 E-Mail : [service@quietek.com](mailto:service@quietek.com)



**TABLE OF CONTENTS**

Description	Page
1. General Information .....	7
1.1. EUT Description.....	7
1.2. Mode of Operation .....	8
1.3. Tested System Details .....	9
1.4. Configuration of Tested System .....	10
1.5. EUT Exercise Software.....	12
2. Technical Test .....	13
2.1. Summary of Test Result.....	13
2.2. List of Test Equipment .....	14
2.3. Measurement Uncertainty.....	17
2.4. Test Environment.....	19
3. Conducted Emission (Main Terminals).....	20
3.1. Test Specification .....	20
3.2. Test Setup.....	20
3.3. Limit .....	20
3.4. Test Procedure .....	21
3.5. Deviation from Test Standard.....	21
3.6. Test Result .....	22
3.7. Test Photograph .....	34
4. Conducted Emissions (Telecommunication Ports).....	36
4.1. Test Specification .....	36
4.2. Test Setup.....	36
4.3. Limit .....	36
4.4. Test Procedure .....	37
4.5. Deviation from Test Standard.....	37
4.6. Test Result .....	38
4.7. Test Photograph .....	56
5. Radiated Emission .....	59
5.1. Test Specification .....	59
5.2. Test Setup.....	59
5.3. Limit .....	60
5.4. Test Procedure .....	61
5.5. Deviation from Test Standard.....	61
5.6. Test Result.....	62
5.7. Test Photograph .....	73
6. Harmonic Current Emission .....	79

6.1.	Test Specification .....	79
6.2.	Test Setup.....	79
6.3.	Limit.....	79
6.4.	Test Procedure .....	81
6.5.	Deviation from Test Standard.....	81
6.6.	Test Result.....	82
6.7.	Test Photograph .....	86
7.	Voltage Fluctuation and Flicker.....	87
7.1.	Test Specification.....	87
7.2.	Test Setup.....	87
7.3.	Limit.....	87
7.4.	Test Procedure .....	88
7.5.	Deviation from Test Standard.....	88
7.6.	Test Result.....	89
7.7.	Test Photograph .....	91
8.	Electrostatic Discharge .....	92
8.1.	Test Specification.....	92
8.2.	Test Setup.....	92
8.3.	Limit.....	92
8.4.	Test Procedure .....	93
8.5.	Deviation from Test Standard.....	93
8.6.	Test Result.....	94
8.7.	Test Photograph .....	97
9.	Radiated Susceptibility .....	99
9.1.	Test Specification.....	99
9.2.	Test Setup.....	99
9.3.	Limit.....	99
9.4.	Test Procedure .....	100
9.5.	Deviation from Test Standard.....	100
9.6.	Test Result.....	101
9.7.	Test Photograph .....	103
10.	Electrical Fast Transient/Burst .....	106
10.1.	Test Specification.....	106
10.2.	Test Setup.....	106
10.3.	Limit.....	106
10.4.	Test Procedure .....	107
10.5.	Deviation from Test Standard.....	107
10.6.	Test Result.....	108

10.7.	Test Photograph .....	111
11.	Surge .....	114
11.1.	Test Specification .....	114
11.2.	Test Setup.....	114
11.3.	Limit.....	114
11.4.	Test Procedure .....	115
11.5.	Deviation from Test Standard.....	115
11.6.	Test Result.....	116
11.7.	Test Photograph .....	118
12.	Conducted Susceptibility.....	119
12.1.	Test Specification .....	119
12.2.	Test Setup.....	119
12.3.	Limit.....	120
12.4.	Test Procedure .....	120
12.5.	Deviation from Test Standard.....	120
12.6.	Test Result.....	121
12.7.	Test Photograph .....	124
13.	Power Frequency Magnetic Field .....	127
13.1.	Test Specification .....	127
13.2.	Test Setup.....	127
13.3.	Limit.....	127
13.4.	Test Procedure .....	127
13.5.	Deviation from Test Standard.....	127
13.6.	Test Result.....	128
13.7.	Test Photograph .....	131
14.	Voltage Dips and Interruption.....	133
14.1.	Test Specification .....	133
14.2.	Test Setup.....	133
14.3.	Limit.....	133
14.4.	Test Procedure .....	134
14.5.	Deviation from Test Standard.....	134
14.6.	Test Result.....	135
14.7.	Test Photograph .....	137
15.	Attachment.....	138
	EUT Photograph.....	138



**1. General Information****1.1. EUT Description**

Product Name	Outdoor Bullet Network Camera
Trade Name	VIVOTEK
Model No.	IP8362

Component	
Power Adapter	MFR: ENG, M/N: 3A-183WP12 Input: AC 100-240V, 50-60Hz, 0.6A Output: DC 12V, 1.5A Cable Out: Non-shielded, 1.5m

**1.2. Mode of Operation**

QuieTek has verified the construction and function in typical operation. All the test modes were carried out with the EUT in normal operation, which was shown in this test report and defined as:

Pre-Test Mode	
Mode 1: Normal Operation (DC 12V)	
Mode 2: Normal Operation (AC 24V)	
Mode 3: Normal Operation (PoE)	
Final Test Mode	
Conducted Emission	Mode 1: Normal Operation (DC 12V) Mode 2: Normal Operation (AC 24V)
Impedance Stabilization Network	Mode 1: Normal Operation (DC 12V) Mode 2: Normal Operation (AC 24V) Mode 3: Normal Operation (PoE)
Radiated Emission	Mode 1: Normal Operation (DC 12V) Mode 2: Normal Operation (AC 24V) Mode 3: Normal Operation (PoE)
Immunity	Mode 1: Normal Operation (DC 12V) Mode 2: Normal Operation (AC 24V) Mode 3: Normal Operation (PoE)

**1.3. Tested System Details**

The types for all equipments, plus descriptions of all cables used in the tested system (including inserted cards) are:

Test Mode		Mode 1, Mode 2			
Product		Manufacturer	Model No.	Serial No.	Power Cord
1	Notebook PC	DELL	PP04X	C8YYM1S	Non-Shielded, 1.8m

Test Mode		Mode 3			
Product		Manufacturer	Model No.	Serial No.	Power Cord
1	Notebook PC	DELL	PP04X	C8YYM1S	Non-Shielded, 1.8m
2	Ethernet Adapter	LINKSYS	WAPPOE12	N/A	Non-Shielded, 1.8m

1.4. Configuration of Tested System

Test Mode	Mode 1, Mode 2		
Connection Diagram			
<pre> graph TD     PC[Notebook PC (I)] --- A --- EUT[EUT]     subgraph Box [ ]         EUT     end             </pre>			
Signal Cable Type		Signal cable Description	
A	LAN Cable	Non-Shielded, 7m	

Test Mode		Mode 3	
Connection Diagram			
<pre> graph TD     EUT[EUT] --- A --- EA[Ethernet Adapter (2)]     EA --- B --- NBP[Notebook PC (1)]     subgraph DashedBox [ ]         EUT     end         </pre>			
Signal Cable Type		Signal cable Description	
A	LAN Cable	Non-Shielded, 0.4m	
B	LAN Cable	Non-Shielded, 7m	

**1.5. EUT Exercise Software**

1	Setup the EUT and simulators as shown on 1.4.
2	Turn on the power of all equipment.
3	The EUT will start to operate and display the video figure from the signal source.
4	The EUT will display “video figure” on monitor.
5	Repeat the above procedure (3) to (4).

## 2. Technical Test

### 2.1. Summary of Test Result

- No deviations from the test standards  
 Deviations from the test standards as below description:

Emission			
Performed Item	Normative References	Test Performed	Deviation
Conducted Emission	EN 55022: 2006+A1: 2007 AS/NZS CISPR 22: 2009	Yes	No
Impedance Stabilization Network	EN 55022: 2006+A1: 2007 AS/NZS CISPR 22: 2009	Yes	No
Radiated Emission	EN 55022: 2006+A1: 2007 AS/NZS CISPR 22: 2009	Yes	No
Power Harmonics	EN 61000-3-2:2006+A2: 2009	Yes	No
Voltage Fluctuation and Flicker	EN 61000-3-3:2008	Yes	No

Immunity			
Performed Item	Normative References	Test Performed	Deviation
Electrostatic Discharge	IEC 61000-4-2: 2008	Yes	No
Radiated susceptibility	IEC 61000-4-3: 2010	Yes	No
Electrical fast transient/burst	IEC 61000-4-4: 2011	Yes	No
Surge	IEC 61000-4-5: 2005	Yes	No
Conducted susceptibility	IEC 61000-4-6: 2008	Yes	No
Power frequency magnetic field	IEC 61000-4-8: 2009	Yes	No
Voltage dips and interruption	IEC 61000-4-11: 2004	Yes	No

**2.2. List of Test Equipment**

Conducted Emission / SR1

Instrument	Manufacturer	Type No.	Serial No	Cal. Date
EMI Test Receiver	R&S	ESCS 30	100366	2010/11/10
LISN	R&S	ENV4200	833209/007	2010/09/06
LISN	R&S	ENV216	100085	2011/02/10
Pulse Limiter	R&S	ESH3-Z2	357.88.10.52	2010/09/02

Impedance Stabilization Network / SR1

Instrument	Manufacturer	Type No.	Serial No	Cal. Date
Capacitive Voltage Probe	Schaffner	CVP2200A	18331	2010/11/15
EMI Test Receiver	R&S	ESCS 30	100366	2010/11/10
LISN	R&S	ENV216	100085	2011/02/10
LISN	R&S	ENV4200	833209/007	2010/09/06
Pulse Limiter	R&S	ESH3-Z2	357.88.10.52	2010/09/02
RF Current Probe	FCC	F-65 10KHz~1GHz	198	2010/11/08
BALANCED TELECOM ISN	FCC	FCC-TLISN-T2-02	20316	2010/06/26
BALANCED TELECOM ISN	FCC	FCC-TLISN-T4-02	20317	2010/06/26
BALANCED TELECOM ISN	FCC	FCC-TLISN-T8-02	20319	2010/06/26

Radiated Emission / Site4

Instrument	Manufacturer	Type No.	Serial No	Cal. Date
Bilog Antenna	Schaffner Chase	CBL6112B	2793	2010/08/01
Broadband Horn Antenna	Schwarzbeck	BBHA9170	209	2010/10/27
EMI Test Receiver	R&S	ESCS 30	100369	2010/09/03
Horn Antenna	Schwarzbeck	BBHA9120D	305	2010/08/26
Pre-Amplifier	QTK	N/A	N/A	2010/08/01
Spectrum Analyzer	Advantest	R3162	100803480	2010/04/09

Radiated Emission / 9x6x6 Chamber

Instrument	Manufacturer	Type No.	Serial No	Cal. Date
Spectrum Analyzer (9K-26.5GHz)	Agilent	E4408B	MY45102743	2010/08/12
Horn Antenna	Schwarzbeck	9120D	576	2010/10/21
Pre-Amplifier	Quietek	AP-180C	CHM/071920	2010/08/04

Power Harmonics / SR3

Instrument	Manufacturer	Type No.	Serial No	Cal. Date
AC Power Source(Harmonic)	Schaffner	NSG 1007	HK54148	2010/08/11
IEC1000-4-X Analyzer(Flicker)	Schaffner	CCN 1000-1	X7 1887	2010/08/11

Voltage Fluctuation and Flicker / SR3

Instrument	Manufacturer	Type No.	Serial No	Cal. Date
AC Power Source(Harmonic)	Schaffner	NSG 1007	HK54148	2010/08/11
IEC1000-4-X Analyzer(Flicker)	Schaffner	CCN 1000-1	X7 1887	2010/08/11



## Electrostatic Discharge / SR6

Instrument	Manufacturer	Type No.	Serial No	Cal. Date
ESD Simulator System	Noiseken	TC-815R	ESS0929097	2010/08/30
Horizontal Coupling Plane(HCP)	Quietek	HCP AL50	N/A	N/A
Vertical Coupling Plane(VCP)	Quietek	VCP AL50	N/A	N/A

## Radiated susceptibility / CB5

Instrument	Manufacturer	Type No.	Serial No	Cal. Date
AF-BOX	R&S	AF-BOX ACCUST	100007	N/A
Audio Analyzer	R&S	UPL 16	100137	2010/04/22
Biconilog Antenna	EMCO	3149	00071675	N/A
Directional Coupler	A&R	DC 6180	22735	N/A
Dual Microphone Supply	B&K	5935	2426784	2010/04/22
Mouth Simulator	B&K	4227	2439692	2010/04/22
Power Amplifier	A&R	30S1G3	309453	N/A
Power Amplifier	A&R	100W10000M7	A285000010	N/A
Power Amplifier	SCHAFFNER	CBA9413B	4020	N/A
Power Amplifier	AR	75A250A	0325371	N/A
Power Meter	R&S	NRVD(P.M)	100219	2010/04/22
Pre-Amplifier	A&R	150A220	23067	N/A
Probe Microphone	B&K	4182	2278070	2010/04/22
Signal Generator	R&S	SML03	103330	2010/04/21

## Electrical fast transient/burst / SR3

Instrument	Manufacturer	Type No.	Serial No	Cal. Date
TRANSIENT TEST SYSTEM	EMC PARTNER	TRA2000IN6	1138	2010/12/09

## Surge / SR3

Instrument	Manufacturer	Type No.	Serial No	Cal. Date
TRANSIENT TEST SYSTEM	EMC PARTNER	TRA2000IN6	1138	2010/12/09

## Conducted susceptibility / SR6

Instrument	Manufacturer	Type No.	Serial No	Cal. Date
Schaffner NSG 2070 RF-Generator	Schaffner	N/A	N/A	2011/04/07

## Power frequency magnetic field / SR3

Instrument	Manufacturer	Type No.	Serial No	Cal. Date
Induction Coil Interface	Schaffner	INA 2141	6002	N/A
Magnetic Loop Coil	Schaffner	INA 702	160	N/A

## Voltage dips and interruption / SR3

Instrument	Manufacturer	Type No.	Serial No	Cal. Date
TRANSIENT TEST SYSTEM	EMC PARTNER	TRA2000IN6	1138	2010/12/09

Schaffner NSG 2070 RF-Generator				
Instrument	Manufacturer	Type No.	Serial No	Cal. Date
CDN	Schaffner	CAL U100A	20405	N/A
CDN	Schaffner	TRA U150	20454	N/A
CDN M016S	Schaffner	CAL U100A	20410	N/A
CDN M016S	Schaffner	TRA U150	21167	N/A
CDN T002	Schaffner	CAL U100	20491	N/A
CDN T002	Schaffner	TRA U150	21169	N/A
CDN T400	Schaffner	CAL U100	17735	N/A
CDN T400	Schaffner	TRA U150	21166	N/A
Coupling Decoupling Network	Schaffner	CDN M016S	20823	2011/04/08
Coupling Decoupling Network	Schaffner	CDN T002	19018	2011/04/08
Coupling Decoupling Network	Schaffner	CDN T400	21226	2011/04/08
EM-CLAMP	Schaffner	KEMZ 801	21024	2011/04/08

## 2.3. Measurement Uncertainty

### Conducted Emission

The measurement uncertainty is evaluated as  $\pm 2.26$  dB.

### Impedance Stabilization Network

The measurement uncertainty is evaluated as  $\pm 2.26$  dB.

### Radiated Emission

The measurement uncertainty is evaluated as  $\pm 3.19$  dB.

### Electrostatic Discharge

As what is concluded in the document from Note2 of clause 5.4.6.2 of ISO/IEC 17025: 1999[2], the requirements for measurement uncertainty in ESD testing are deemed to have been satisfied, and the testing is reported in accordance with the relevant ESD standards. The immunity test signal from the ESD system meet the required specifications in IEC 61000-4-2 through the calibration report with the calibrated uncertainty for the waveform of voltage and timing as being 1.0 % and 0.1%.

### Radiated susceptibility

As what is concluded in the document from Note2 of clause 5.4.6.2 of ISO/IEC 17025: 1999[2], the requirements for measurement uncertainty in RS testing are deemed to have been satisfied, and the testing is reported in accordance with the relevant RS standards. The immunity test signal from the RS system meet the required specifications in IEC 61000-4-3 through the calibration for the uniform field strength and monitoring for the test level with the uncertainty evaluation report for the electrical field strength as being 3.57 dB.

### Electrical fast transient/burst

As what is concluded in the document from Note2 of clause 5.4.6.2 of ISO/IEC 17025: 1999[2], the requirements for measurement uncertainty in EFT/Burst testing are deemed to have been satisfied, and the testing is reported in accordance with the relevant EFT/Burst standards. The immunity test signal from the EFT/Burst system meet the required specifications in IEC 61000-4-4 through the calibration report with the calibrated uncertainty for the waveform of voltage, frequency and timing as being 4 %, and 2.5%.

### Surge

As what is concluded in the document from Note2 of clause 5.4.6.2 of ISO/IEC 17025: 1999[2], the requirements for measurement uncertainty in Surge testing are deemed to have been satisfied, and the testing is reported in accordance with the relevant Surge standards. The immunity test signal from the Surge system meet the required specifications in IEC 61000-4-5 through the calibration report with the calibrated uncertainty for the waveform of voltage and timing as being 3.5 % and 0.1%.

#### Conducted susceptibility

As what is concluded in the document from Note2 of clause 5.4.6.2 of ISO/IEC 17025: 1999[2], the requirements for measurement uncertainty in CS testing are deemed to have been satisfied, and the testing is reported in accordance with the relevant CS standards. The immunity test signal from the CS system meet the required specifications in IEC 61000-4-6 through the calibration for unmodulated signal and monitoring for the test level with the uncertainty evaluation report for the injected modulated signal level through CDN and EM Clamp/Direct Injection as being 2.0 dB and 2.61 dB.

#### Power frequency magnetic field

As what is concluded in the document from Note2 of clause 5.4.6.2 of ISO/IEC 17025: 1999[2], the requirements for measurement uncertainty in PFM testing are deemed to have been satisfied, and the testing is reported in accordance with the relevant PFM standards. The immunity test signal from the PFM system meet the required specifications in IEC 61000-4-8 through the calibration report with the calibrated uncertainty for the Gauss Meter to verify the output level of magnetic field strength as being 2.0 %.

#### Voltage dips and interruption

As what is concluded in the document from Note2 of clause 5.4.6.2 of ISO/IEC 17025: 1999[2], the requirements for measurement uncertainty in DIP testing are deemed to have been satisfied, and the testing is reported in accordance with the relevant DIP standards. The immunity test signal from the DIP system meet the required specifications in IEC 61000-4-11 through the calibration report with the calibrated uncertainty for the waveform of voltage and timing as being 3.5 % and 0.1%.

## 2.4. Test Environment

Performed Item	Items	Required	Actual
Conducted Emission	Temperature (°C)	15-35	25
	Humidity (%RH)	25-75	50
	Barometric pressure (mbar)	860-1060	950-1000
Impedance Stabilization Network	Temperature (°C)	15-35	25
	Humidity (%RH)	25-75	50
	Barometric pressure (mbar)	860-1060	950-1000
Radiated Emission	Temperature (°C)	15-35	25
	Humidity (%RH)	25-75	50
	Barometric pressure (mbar)	860-1060	950-1000
Electrostatic Discharge	Temperature (°C)	15-35	21
	Humidity (%RH)	30-60	53
	Barometric pressure (mbar)	860-1060	950-1000
Radiated susceptibility	Temperature (°C)	15-35	22
	Humidity (%RH)	25-75	55
	Barometric pressure (mbar)	860-1060	950-1000
Electrical fast transient/burst	Temperature (°C)	15-35	22
	Humidity (%RH)	25-75	57
	Barometric pressure (mbar)	860-1060	950-1000
Surge	Temperature (°C)	15-35	22
	Humidity (%RH)	10-75	57
	Barometric pressure (mbar)	860-1060	950-1000
Conducted susceptibility	Temperature (°C)	15-35	21
	Humidity (%RH)	25-75	53
	Barometric pressure (mbar)	860-1060	950-1000
Power frequency magnetic field	Temperature (°C)	15-35	21
	Humidity (%RH)	25-75	50
	Barometric pressure (mbar)	860-1060	950-1000
Voltage dips and interruption	Temperature (°C)	15-35	22
	Humidity (%RH)	25-75	57
	Barometric pressure (mbar)	860-1060	950-1000

### 3. Conducted Emission (Main Terminals)

#### 3.1. Test Specification

According to EMC Standard : EN 55022 and AS/NZS CISPR 22

#### 3.2. Test Setup

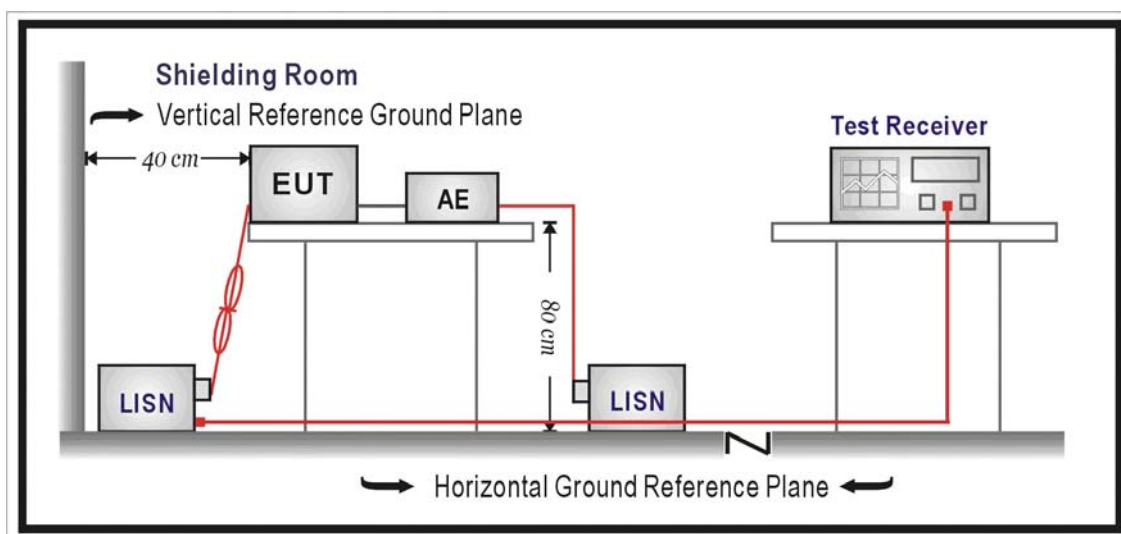

#### 3.3. Limit

Limits		
Frequency (MHz)	QP (dBuV)	AV (dBuV)
0.15 - 0.50	79	66
0.50-5.0	73	60
5.0 - 30	73	60

Remarks: In the above table, the tighter limit applies at the band edges.

### 3.4. Test Procedure

The EUT and simulators are connected to the main power through a line impedance stabilization network (L.I.S.N.). This provides a 50 ohm /50uH coupling impedance for the measuring equipment. The peripheral devices are also connected to the main power through a LISN that provides a 50ohm/50uH coupling impedance with 50ohm termination.

(Please refers to the block diagram of the test setup and photographs.)

Both sides of A.C. line are checked for maximum conducted interference. In order to find the maximum emission, the relative positions of equipment and all of the interface cables must be changed on conducted measurement.

Conducted emissions were invested over the frequency range from 0.15MHz to 30MHz using a receiver bandwidth of 9kHz.

### 3.5. Deviation from Test Standard

No deviation.

**3.6. Test Result**

Site : SR_1	Time : 2011/04/09 - 13:15
Limit : CISPR_A_00M_QP	Margin : 13
EUT : Outdoor Bullet Network Camera	Probe : ENV_216_L1 - Line1
Power : AC 230V/50Hz	Note : Mode 1





Site : SR_1	Time : 2011/04/09 - 13:28
Limit : CISPR_A_00M_QP	Margin : 0
EUT : Outdoor Bullet Network Camera	Probe : ENV_216_L1 - Line1
Power : AC 230V/50Hz	Note : Mode 1

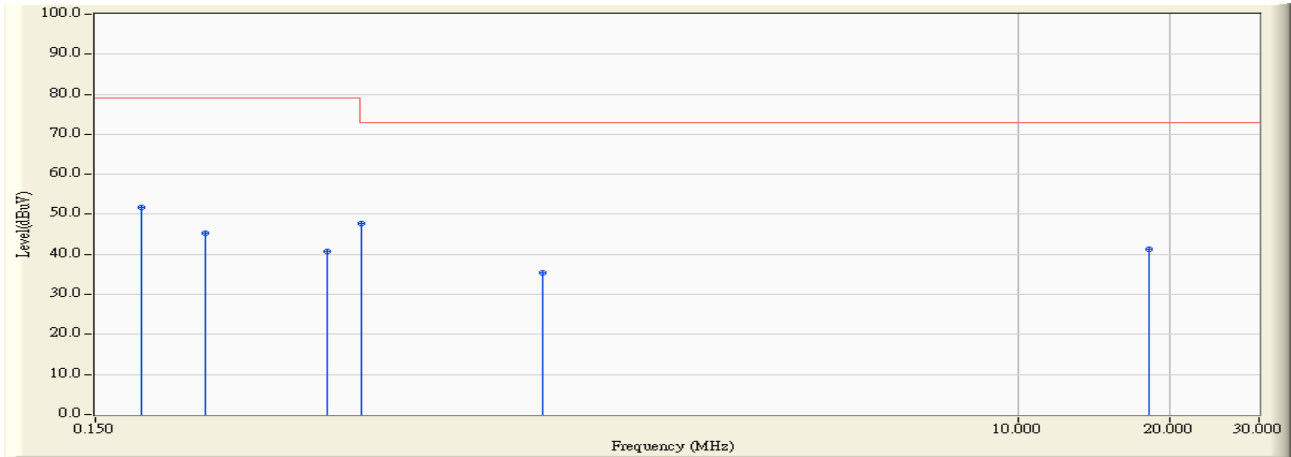

		Frequency (MHz)	Correct Factor (dB)	Reading Level (dBuV)	Measure Level (dBuV)	Margin (dB)	Limit (dBuV)	Detector Type
1		0.185	9.790	42.020	51.810	-27.190	79.000	QUASIPeAK
2		0.248	9.790	35.500	45.290	-33.710	79.000	QUASIPeAK
3		0.431	9.790	31.090	40.880	-38.120	79.000	QUASIPeAK
4	*	0.502	9.790	38.020	47.810	-25.190	73.000	QUASIPeAK
5		1.146	9.800	25.680	35.480	-37.520	73.000	QUASIPeAK
6		18.244	10.110	31.060	41.170	-31.830	73.000	QUASIPeAK

**Note:**

1. All Reading Levels are Quasi-Peak and average value.
2. " \* ", means this data is the worst emission level.
3. Measurement Level = Reading Level + Correct Factor

Site : SR_1	Time : 2011/04/09 - 13:28
Limit : CISPR_A_00M_AV	Margin : 0
EUT : Outdoor Bullet Network Camera	Probe : ENV_216_L1 - Line1
Power : AC 230V/50Hz	Note : Mode 1

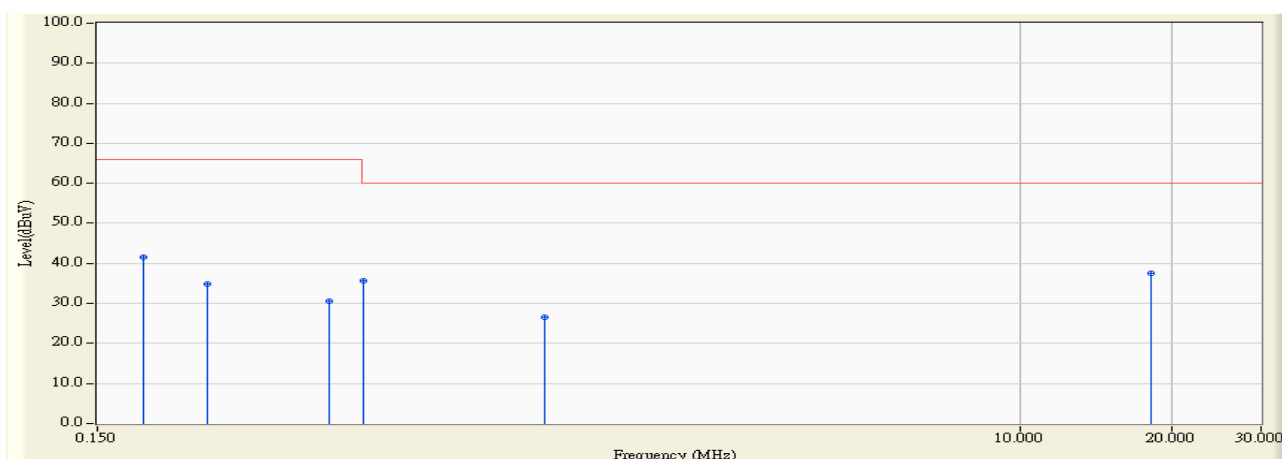

		Frequency (MHz)	Correct Factor (dB)	Reading Level (dBuV)	Measure Level (dBuV)	Margin (dB)	Limit (dBuV)	Detector Type
1		0.185	9.790	31.830	41.620	-24.380	66.000	AVERAGE
2		0.248	9.790	24.950	34.740	-31.260	66.000	AVERAGE
3		0.431	9.790	20.790	30.580	-35.420	66.000	AVERAGE
4		0.502	9.790	25.810	35.600	-24.400	60.000	AVERAGE
5		1.146	9.800	16.620	26.420	-33.580	60.000	AVERAGE
6	*	18.244	10.110	27.420	37.530	-22.470	60.000	AVERAGE

**Note:**

1. All Reading Levels are Quasi-Peak and average value.
2. " \* ", means this data is the worst emission level.
3. Measurement Level = Reading Level + Correct Factor

Site : SR_1	Time : 2011/04/09 - 13:28
Limit : CISPR_A_00M_QP	Margin : 13
EUT : Outdoor Bullet Network Camera	Probe : ENV_216_N - Line2
Power : AC 230V/50Hz	Note : Mode 1



Site : SR_1	Time : 2011/04/09 - 13:29
Limit : CISPR_A_00M_QP	Margin : 0
EUT : Outdoor Bullet Network Camera	Probe : ENV_216_N - Line2
Power : AC 230V/50Hz	Note : Mode 1

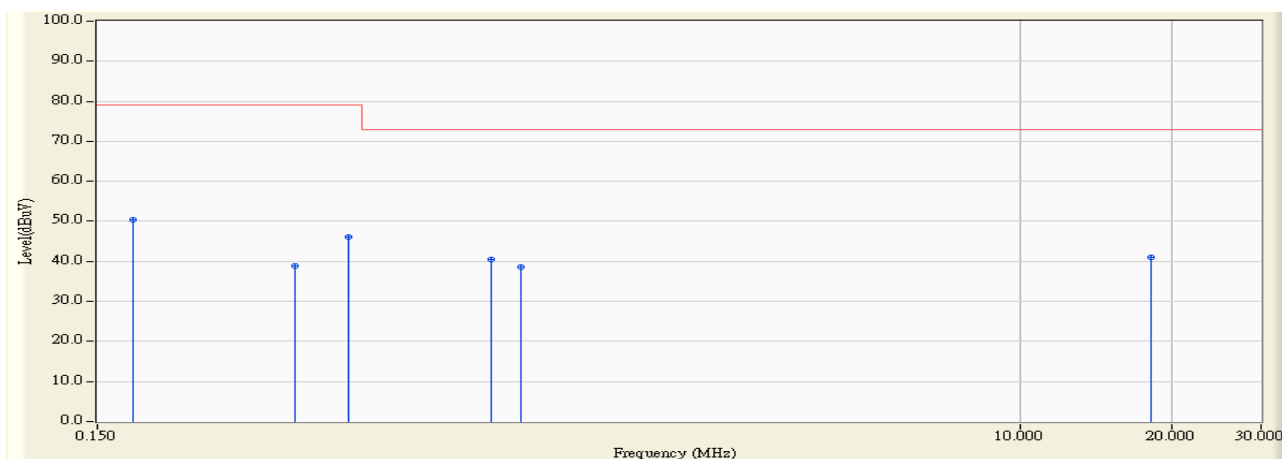

		Frequency (MHz)	Correct Factor (dB)	Reading Level (dBuV)	Measure Level (dBuV)	Margin (dB)	Limit (dBuV)	Detector Type
1	*	0.177	9.780	40.510	50.290	-28.710	79.000	QUASPEAK
2		0.369	9.790	28.950	38.740	-40.260	79.000	QUASPEAK
3		0.470	9.790	36.220	46.010	-32.990	79.000	QUASPEAK
4		0.904	9.790	30.610	40.400	-32.600	73.000	QUASPEAK
5		1.033	9.790	28.810	38.600	-34.400	73.000	QUASPEAK
6		18.244	10.210	30.790	41.000	-32.000	73.000	QUASPEAK

**Note:**

1. All Reading Levels are Quasi-Peak and average value.
2. " \* ", means this data is the worst emission level.
3. Measurement Level = Reading Level + Correct Factor

Site : SR_1	Time : 2011/04/09 - 13:29
Limit : CISPR_A_00M_AV	Margin : 0
EUT : Outdoor Bullet Network Camera	Probe : ENV_216_N - Line2
Power : AC 230V/50Hz	Note : Mode 1

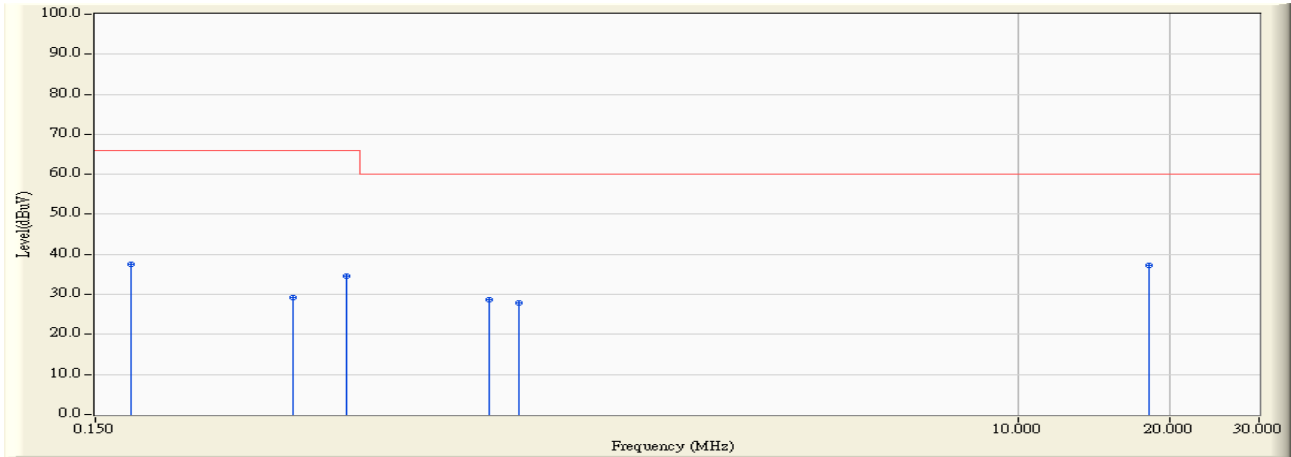

		Frequency (MHz)	Correct Factor (dB)	Reading Level (dBuV)	Measure Level (dBuV)	Margin (dB)	Limit (dBuV)	Detector Type
1		0.177	9.780	27.720	37.500	-28.500	66.000	AVERAGE
2		0.369	9.790	19.500	29.290	-36.710	66.000	AVERAGE
3		0.470	9.790	24.710	34.500	-31.500	66.000	AVERAGE
4		0.904	9.790	18.880	28.670	-31.330	60.000	AVERAGE
5		1.033	9.790	18.020	27.810	-32.190	60.000	AVERAGE
6	*	18.244	10.210	27.110	37.320	-22.680	60.000	AVERAGE

**Note:**

1. All Reading Levels are Quasi-Peak and average value.
2. " \* ", means this data is the worst emission level.
3. Measurement Level = Reading Level + Correct Factor

Site : SR_1	Time : 2011/04/09 - 14:18
Limit : CISPR_A_00M_QP	Margin : 13
EUT : Outdoor Bullet Network Camera	Probe : ENV_216_L1 - Line1
Power : AC 230V/50Hz	Note : Mode 2

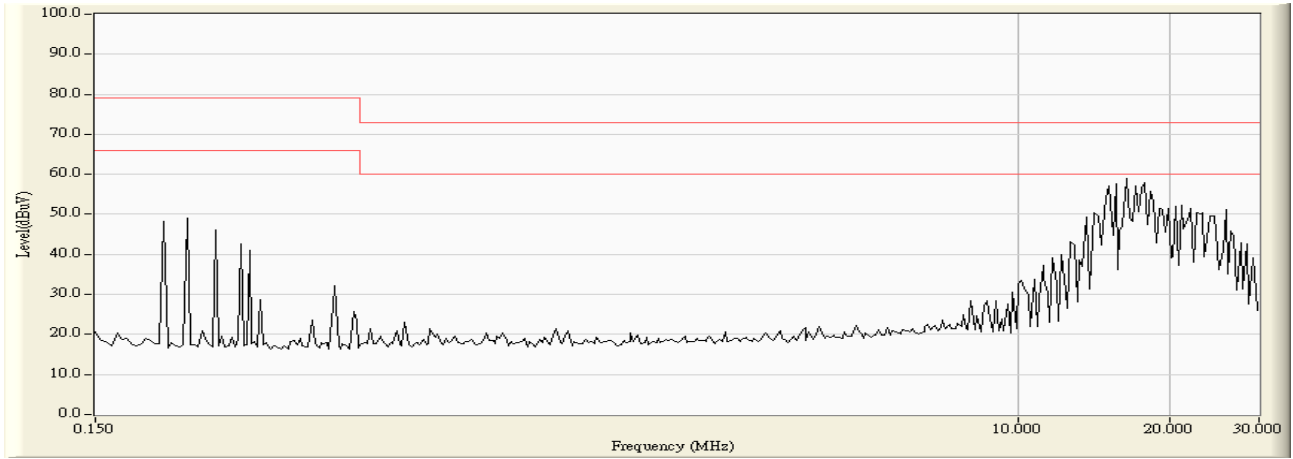

Site : SR_1	Time : 2011/04/09 - 14:19
Limit : CISPR_A_00M_QP	Margin : 0
EUT : Outdoor Bullet Network Camera	Probe : ENV_216_L1 - Line1
Power : AC 230V/50Hz	Note : Mode 2

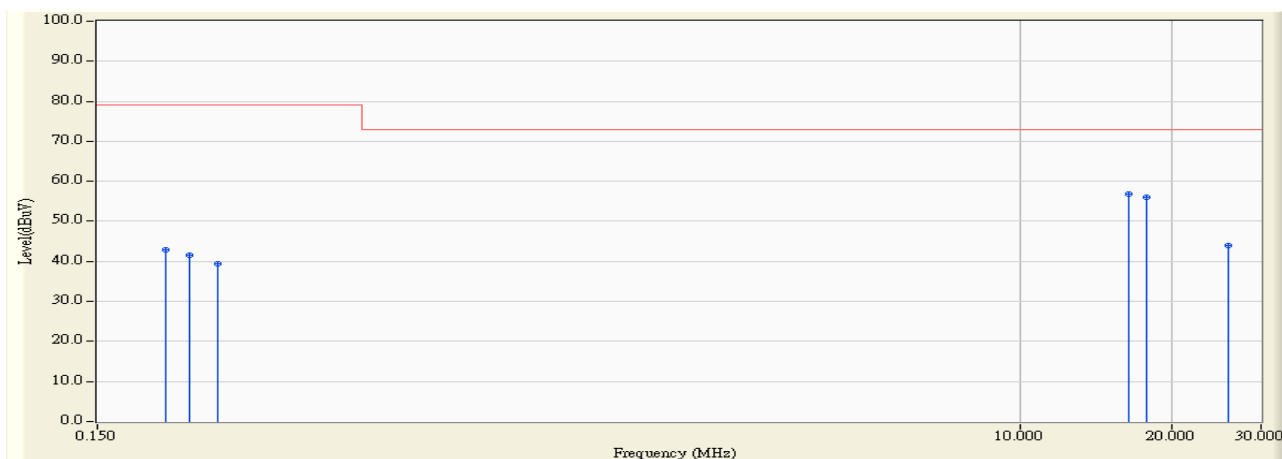

		Frequency (MHz)	Correct Factor (dB)	Reading Level (dBuV)	Measure Level (dBuV)	Margin (dB)	Limit (dBuV)	Detector Type
1		0.205	9.790	33.200	42.990	-36.010	79.000	QUASPEAK
2		0.228	9.790	31.840	41.630	-37.370	79.000	QUASPEAK
3		0.259	9.790	29.700	39.490	-39.510	79.000	QUASPEAK
4	*	16.389	10.110	46.760	56.870	-16.130	73.000	QUASPEAK
5		17.861	10.110	46.030	56.140	-16.860	73.000	QUASPEAK
6		25.927	10.140	33.920	44.060	-28.940	73.000	QUASPEAK

**Note:**

1. All Reading Levels are Quasi-Peak and average value.
2. " \* ", means this data is the worst emission level.
3. Measurement Level = Reading Level + Correct Factor

Site : SR_1	Time : 2011/04/09 - 14:19
Limit : CISPR_A_00M_AV	Margin : 0
EUT : Outdoor Bullet Network Camera	Probe : ENV_216_L1 - Line1
Power : AC 230V/50Hz	Note : Mode 2

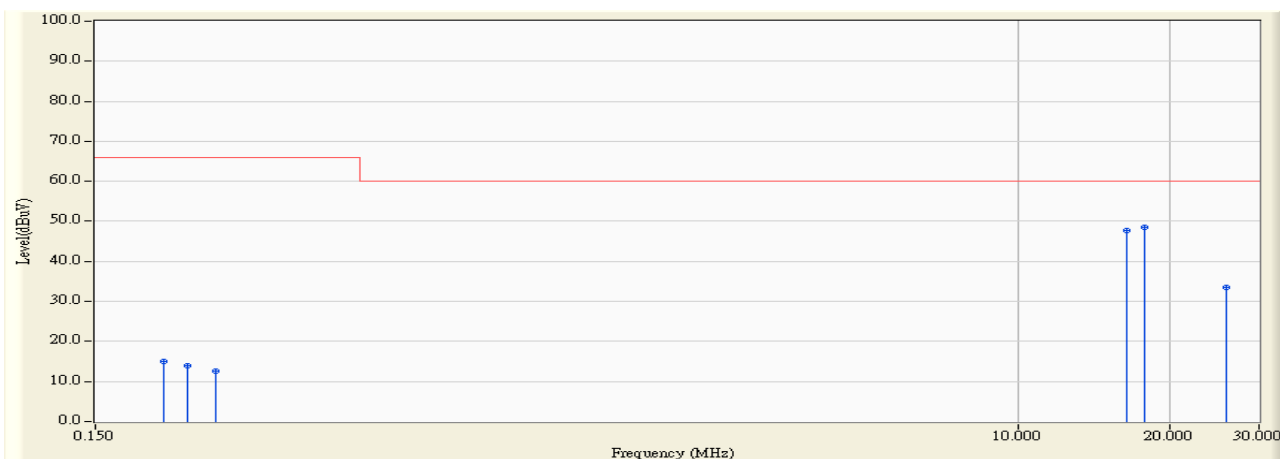

		Frequency (MHz)	Correct Factor (dB)	Reading Level (dBuV)	Measure Level (dBuV)	Margin (dB)	Limit (dBuV)	Detector Type
1		0.205	9.790	5.110	14.900	-51.100	66.000	AVERAGE
2		0.228	9.790	4.260	14.050	-51.950	66.000	AVERAGE
3		0.259	9.790	2.910	12.700	-53.300	66.000	AVERAGE
4		16.389	10.110	37.610	47.720	-12.280	60.000	AVERAGE
5	*	17.861	10.110	38.410	48.520	-11.480	60.000	AVERAGE
6		25.927	10.140	23.250	33.390	-26.610	60.000	AVERAGE

**Note:**

1. All Reading Levels are Quasi-Peak and average value.
2. " \* ", means this data is the worst emission level.
3. Measurement Level = Reading Level + Correct Factor



Site : SR_1	Time : 2011/04/09 - 14:20
Limit : CISPR_A_00M_QP	Margin : 13
EUT : Outdoor Bullet Network Camera	Probe : ENV_216_N - Line2
Power : AC 230V/50Hz	Note : Mode 2

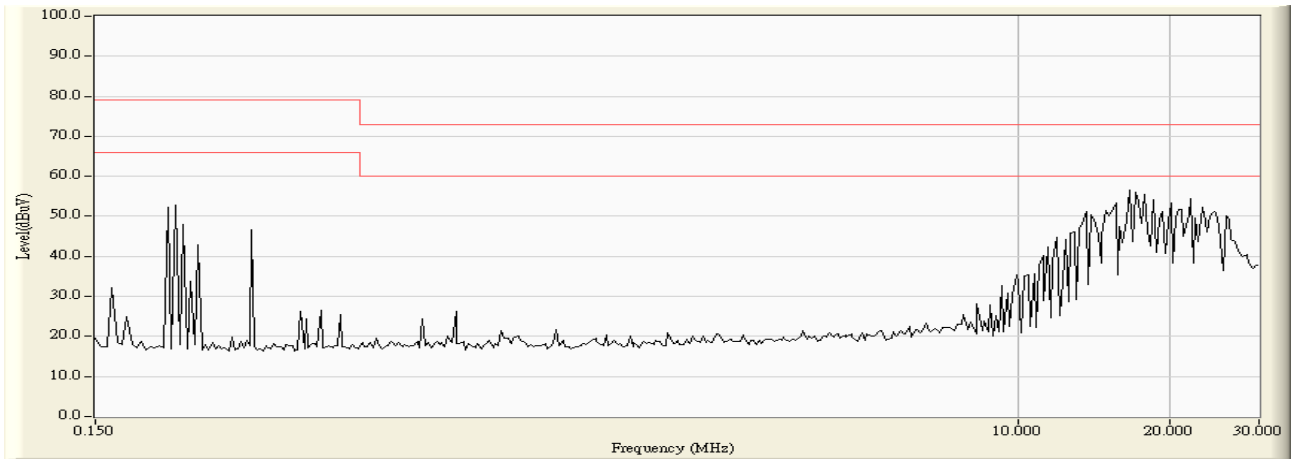

Site : SR_1	Time : 2011/04/09 - 14:21
Limit : CISPR_A_00M_QP	Margin : 0
EUT : Outdoor Bullet Network Camera	Probe : ENV_216_N - Line2
Power : AC 230V/50Hz	Note : Mode 2

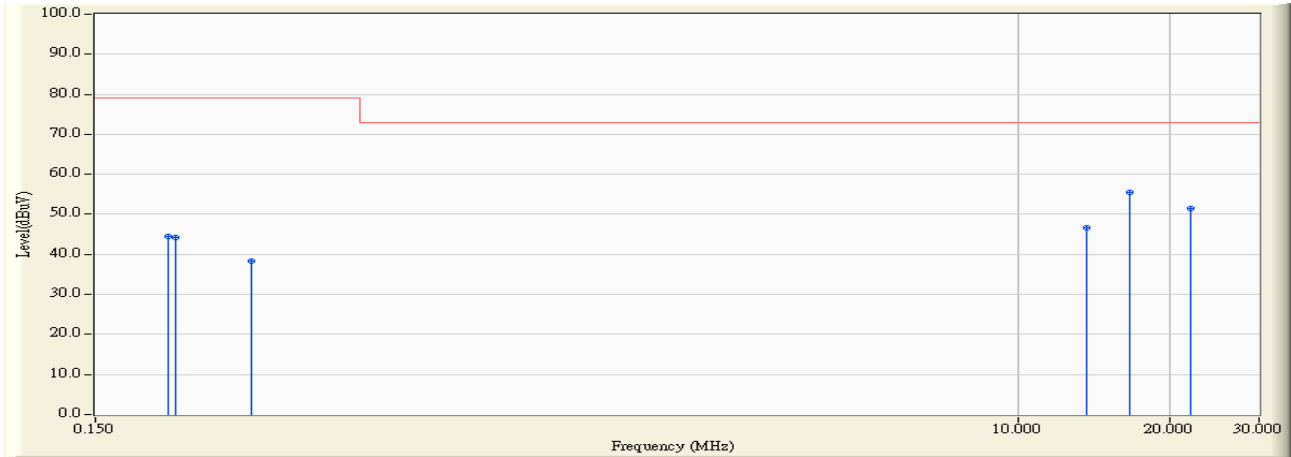

		Frequency (MHz)	Correct Factor (dB)	Reading Level (dBuV)	Measure Level (dBuV)	Margin (dB)	Limit (dBuV)	Detector Type
1		0.209	9.780	34.710	44.490	-34.510	79.000	QUASPEAK
2		0.216	9.780	34.530	44.310	-34.690	79.000	QUASPEAK
3		0.306	9.789	28.440	38.229	-40.771	79.000	QUASPEAK
4		13.697	10.150	36.520	46.670	-26.330	73.000	QUASPEAK
5	*	16.634	10.190	45.400	55.590	-17.410	73.000	QUASPEAK
6		22.017	10.250	41.120	51.370	-21.630	73.000	QUASPEAK

**Note:**

1. All Reading Levels are Quasi-Peak and average value.
2. " \* ", means this data is the worst emission level.
3. Measurement Level = Reading Level + Correct Factor

Site : SR_1	Time : 2011/04/09 - 14:21
Limit : CISPR_A_00M_AV	Margin : 0
EUT : Outdoor Bullet Network Camera	Probe : ENV_216_N - Line2
Power : AC 230V/50Hz	Note : Mode 2

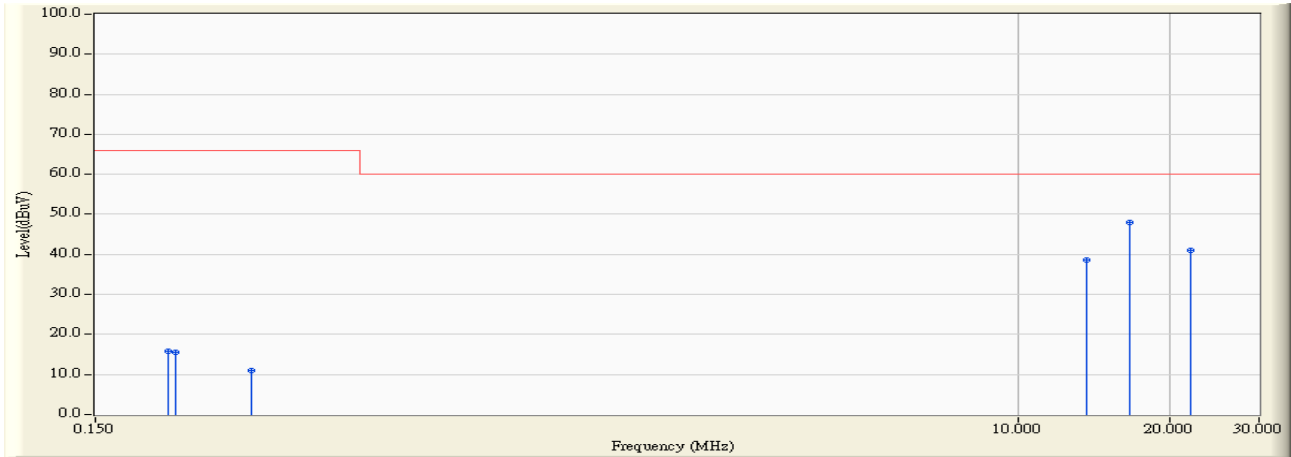

		Frequency (MHz)	Correct Factor (dB)	Reading Level (dBuV)	Measure Level (dBuV)	Margin (dB)	Limit (dBuV)	Detector Type
1		0.209	9.780	5.920	15.700	-50.300	66.000	AVERAGE
2		0.216	9.780	5.730	15.510	-50.490	66.000	AVERAGE
3		0.306	9.789	1.220	11.009	-54.991	66.000	AVERAGE
4		13.697	10.150	28.530	38.680	-21.320	60.000	AVERAGE
5	*	16.634	10.190	37.820	48.010	-11.990	60.000	AVERAGE
6		22.017	10.250	30.740	40.990	-19.010	60.000	AVERAGE

**Note:**

1. All Reading Levels are Quasi-Peak and average value.
2. " \* ", means this data is the worst emission level.
3. Measurement Level = Reading Level + Correct Factor

### 3.7. Test Photograph

Test Mode : Mode 1: Normal Operation (DC 12V)

Description : Front View of Conducted Test



Test Mode : Mode 1: Normal Operation (DC 12V)

Description : Back View of Conducted Test



Test Mode : Mode 2: Normal Operation (AC 24V)

Description : Front View of Conducted Test



Test Mode : Mode 2: Normal Operation (AC 24V)

Description : Back View of Conducted Test



#### 4. Conducted Emissions (Telecommunication Ports)

##### 4.1. Test Specification

According to EMC Standard : EN 55022 and AS/NZS CISPR 22

##### 4.2. Test Setup

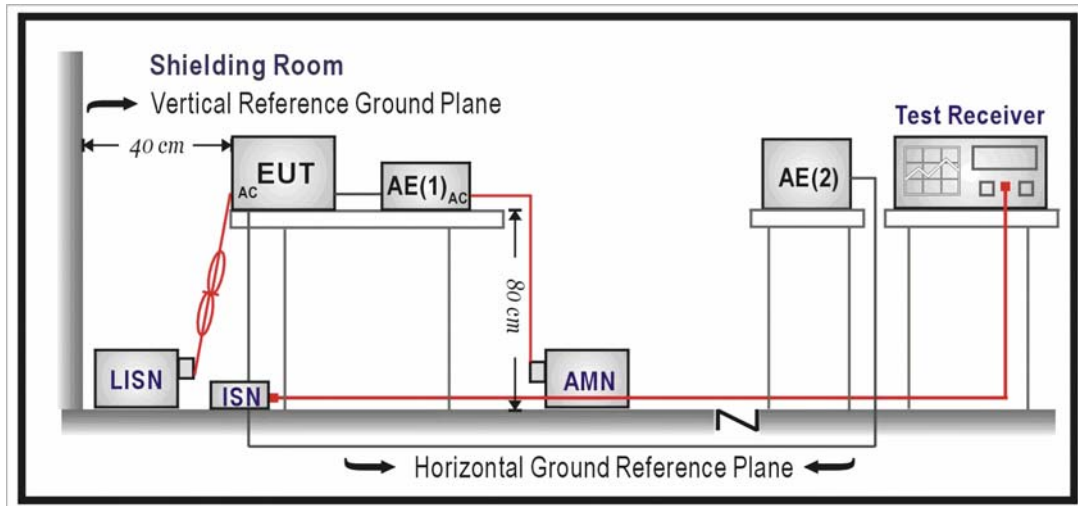

##### 4.3. Limit

Limits		
Frequency (MHz)	QP (dBuV)	AV (dBuV)
0.15 - 0.50	97 – 87	84 – 74
0.50 - 30	87	74

Remarks:

The limit decreases linearly with the logarithm of the frequency in the range 0.15 MHz~0.50 MHz.

#### **4.4. Test Procedure**

##### **Telecommunication Port:**

The mains voltage shall be supplied to the EUT via the LISN when the measurement of telecommunication port is performed. The common mode disturbances at the telecommunication port shall be connected to the ISN, which is 150 ohm impedance.

Both alternative cables are tested related to the LCL requested. The measurement range is from 150kHz to 30MHz. The bandwidth of measurement is set to 9kHz.

The 75dB LCL ISN is used for cat. 6 cable, the 65dB LCL ISN is used for cat. 5 cable, 55dB LCL ISN is used for cat. 3.

#### **4.5. Deviation from Test Standard**

No deviation.

## 4.6. Test Result

Site : SR_1	Time : 2011/04/09 - 13:55
Limit : ISN_Voltage_A_00M_QP	Margin : 13
EUT : Outdoor Bullet Network Camera	Probe : ISN_T4 - Line1
Power : AC 230V/50Hz	Note : Mode 1, ISN 10Mbps

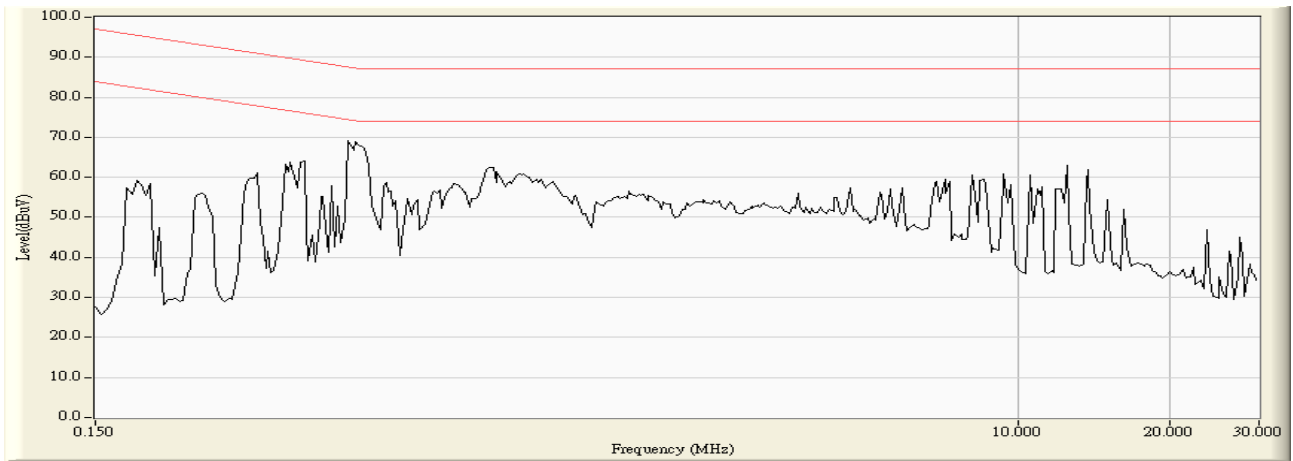



Site : SR_1	Time : 2011/04/09 - 13:55
Limit : ISN_Voltage_A_00M_QP	Margin : 0
EUT : Outdoor Bullet Network Camera	Probe : ISN_T4 - Line1
Power : AC 230V/50Hz	Note : Mode 1, ISN 10Mbps

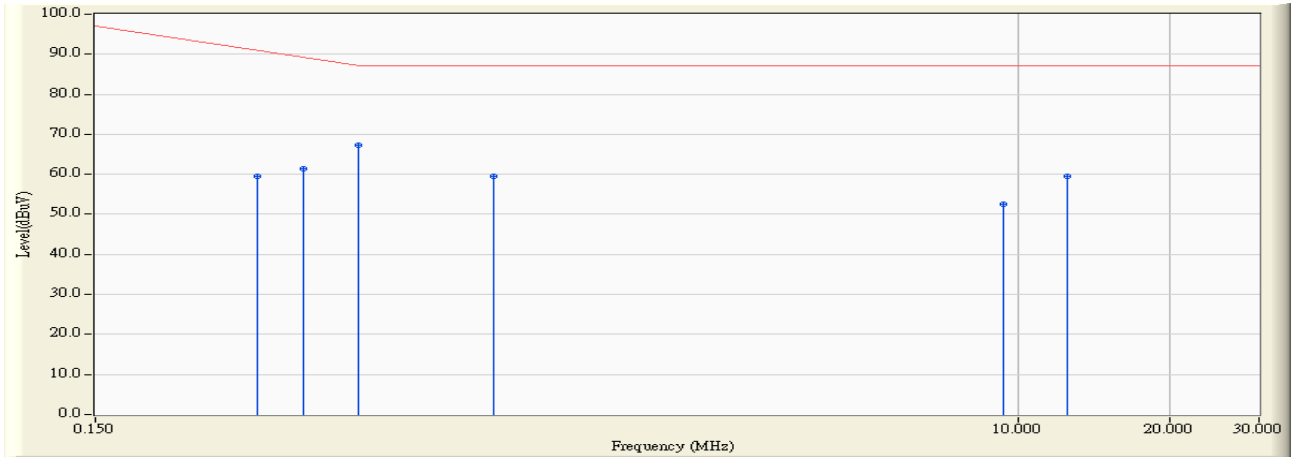

		Frequency (MHz)	Correct Factor (dB)	Reading Level (dBuV)	Measure Level (dBuV)	Margin (dB)	Limit (dBuV)	Detector Type
1		0.314	10.015	49.540	59.555	-32.759	92.314	QUASIPeAK
2		0.388	10.000	51.410	61.410	-28.790	90.200	QUASIPeAK
3	*	0.496	9.990	57.240	67.230	-19.884	87.114	QUASIPeAK
4		0.920	9.980	49.440	59.420	-27.580	87.000	QUASIPeAK
5		9.400	9.960	42.650	52.610	-34.390	87.000	QUASIPeAK
6		12.502	10.073	49.530	59.603	-27.397	87.000	QUASIPeAK

**Note:**

1. All Reading Levels are Quasi-Peak and average value.
2. " \* ", means this data is the worst emission level.
3. Measurement Level = Reading Level + Correct Factor

Site : SR_1	Time : 2011/04/09 - 13:55
Limit : ISN_Voltage_A_00M_AV	Margin : 0
EUT : Outdoor Bullet Network Camera	Probe : ISN_T4 - Line1
Power : AC 230V/50Hz	Note : Mode 1, ISN 10Mbps

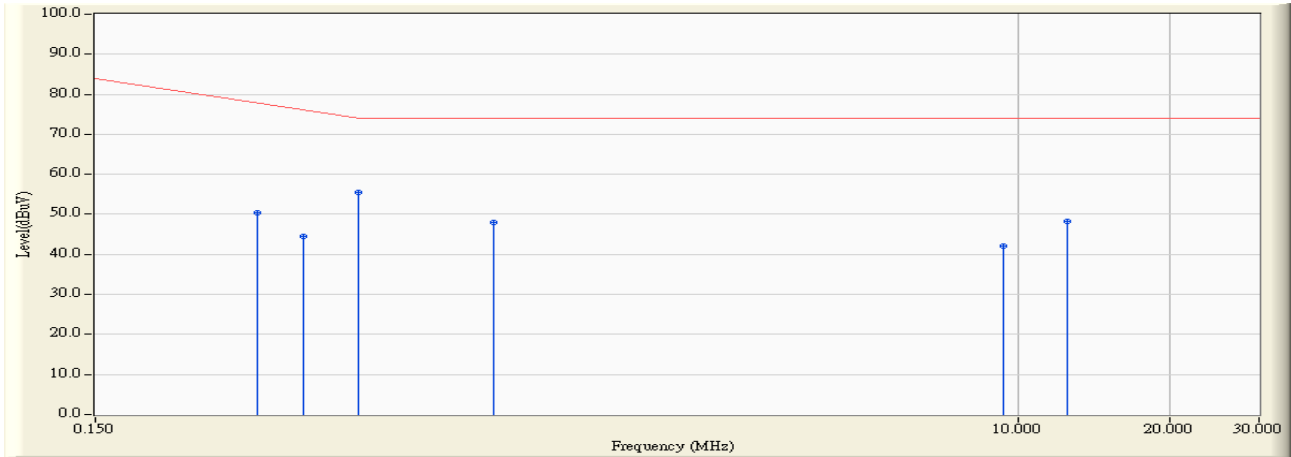

		Frequency (MHz)	Correct Factor (dB)	Reading Level (dBuV)	Measure Level (dBuV)	Margin (dB)	Limit (dBuV)	Detector Type
1		0.314	10.015	40.320	50.335	-28.979	79.314	AVERAGE
2		0.388	10.000	34.390	44.390	-32.810	77.200	AVERAGE
3	*	0.496	9.990	45.550	55.540	-18.574	74.114	AVERAGE
4		0.920	9.980	37.890	47.870	-26.130	74.000	AVERAGE
5		9.400	9.960	32.240	42.200	-31.800	74.000	AVERAGE
6		12.502	10.073	38.190	48.263	-25.737	74.000	AVERAGE

**Note:**

1. All Reading Levels are Quasi-Peak and average value.
2. " \* ", means this data is the worst emission level.
3. Measurement Level = Reading Level + Correct Factor

Site : SR_1	Time : 2011/04/09 - 13:56
Limit : ISN_Voltage_A_00M_QP	Margin : 13
EUT : Outdoor Bullet Network Camera	Probe : ISN_T4 - Line1
Power : AC 230V/50Hz	Note : Mode 1, ISN 100Mbps

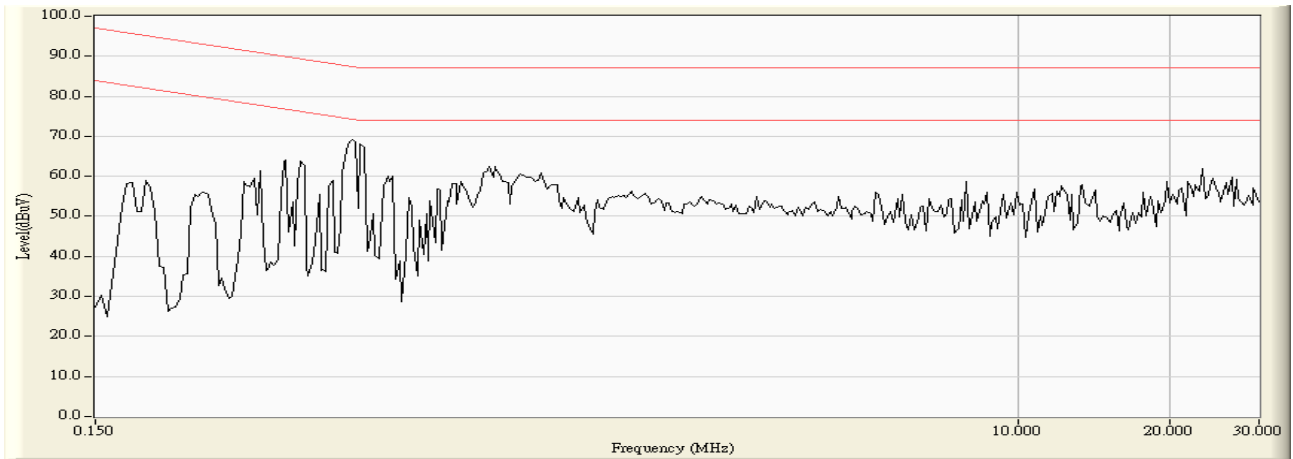

Site : SR_1	Time : 2011/04/09 - 13:56
Limit : ISN_Voltage_A_00M_QP	Margin : 0
EUT : Outdoor Bullet Network Camera	Probe : ISN_T4 - Line1
Power : AC 230V/50Hz	Note : Mode 1, ISN 100Mbps

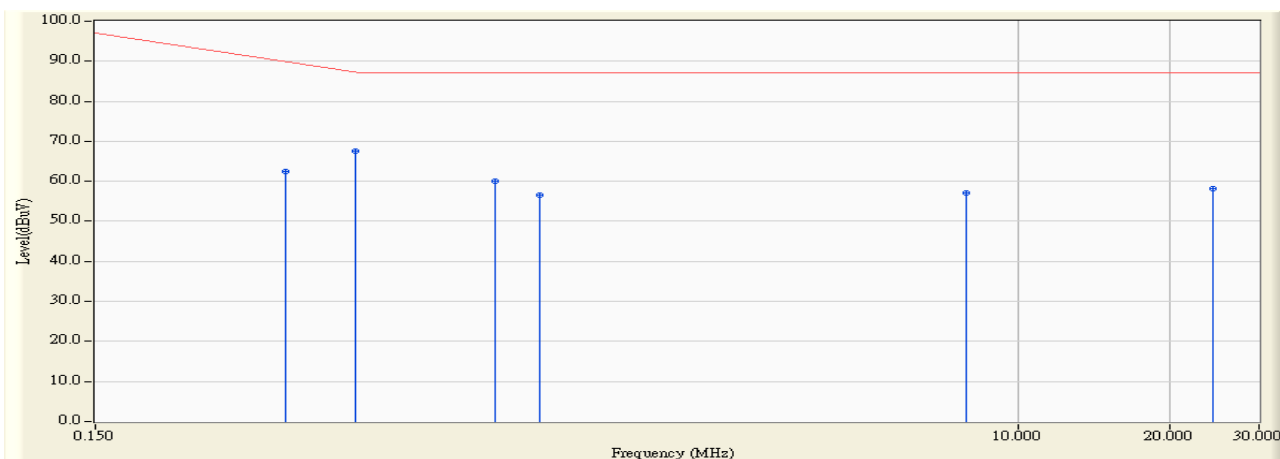

		Frequency (MHz)	Correct Factor (dB)	Reading Level (dBuV)	Measure Level (dBuV)	Margin (dB)	Limit (dBuV)	Detector Type
1		0.357	10.010	52.380	62.390	-28.696	91.086	QUASIPeAK
2	*	0.490	9.990	57.580	67.570	-19.716	87.286	QUASIPeAK
3		0.927	9.980	50.190	60.170	-26.830	87.000	QUASIPeAK
4		1.138	9.980	46.680	56.660	-30.340	87.000	QUASIPeAK
5		7.923	9.970	47.170	57.140	-29.860	87.000	QUASIPeAK
6		24.349	10.100	48.160	58.260	-28.740	87.000	QUASIPeAK

**Note:**

1. All Reading Levels are Quasi-Peak and average value.
2. " \* ", means this data is the worst emission level.
3. Measurement Level = Reading Level + Correct Factor

Site : SR_1	Time : 2011/04/09 - 13:56
Limit : ISN_Voltage_A_00M_AV	Margin : 0
EUT : Outdoor Bullet Network Camera	Probe : ISN_T4 - Line1
Power : AC 230V/50Hz	Note : Mode 1, ISN 100Mbps

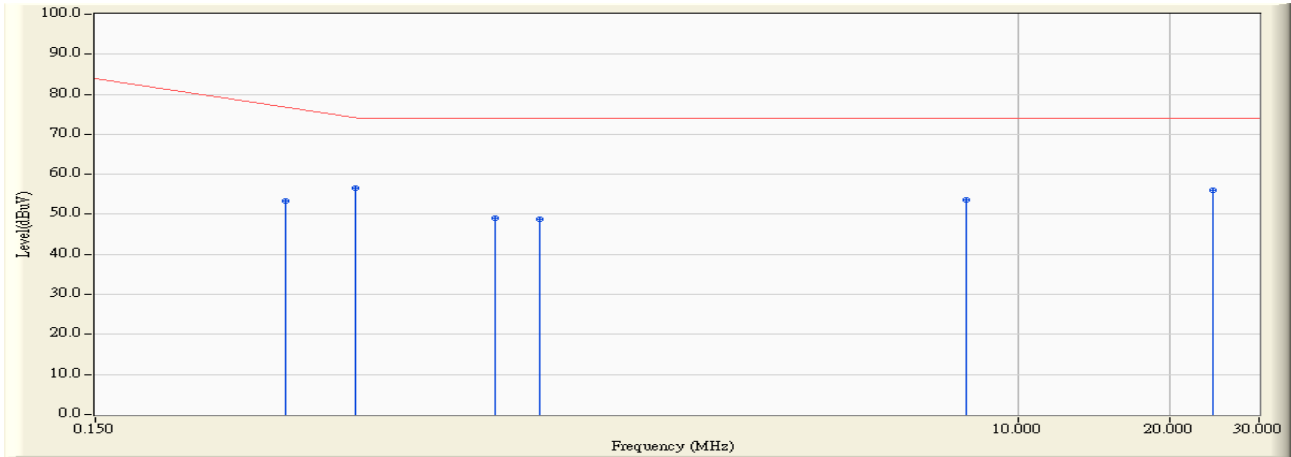

		Frequency (MHz)	Correct Factor (dB)	Reading Level (dBuV)	Measure Level (dBuV)	Margin (dB)	Limit (dBuV)	Detector Type
1		0.357	10.010	43.240	53.250	-24.836	78.086	AVERAGE
2	*	0.490	9.990	46.630	56.620	-17.666	74.286	AVERAGE
3		0.927	9.980	39.050	49.030	-24.970	74.000	AVERAGE
4		1.138	9.980	38.740	48.720	-25.280	74.000	AVERAGE
5		7.923	9.970	43.780	53.750	-20.250	74.000	AVERAGE
6		24.349	10.100	46.060	56.160	-17.840	74.000	AVERAGE

**Note:**

1. All Reading Levels are Quasi-Peak and average value.
2. " \* ", means this data is the worst emission level.
3. Measurement Level = Reading Level + Correct Factor

Site : SR_1	Time : 2011/04/09 - 14:13
Limit : ISN_Voltage_A_00M_QP	Margin : 13
EUT : Outdoor Bullet Network Camera	Probe : ISN_T4 - Line1
Power : AC 230V/50Hz to AC 24V	Note : Mode 2, ISN 10Mbps

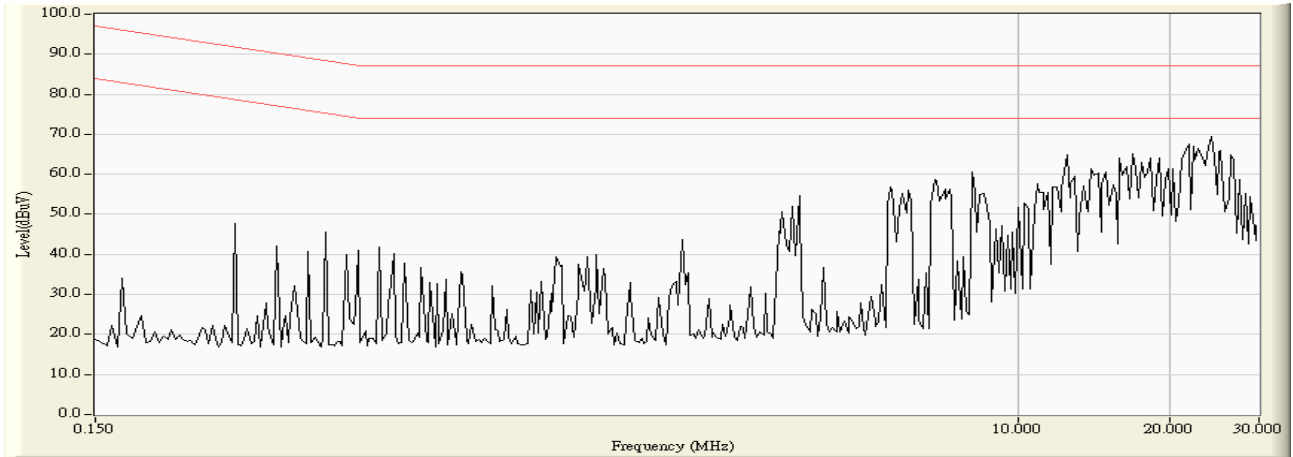

Site : SR_1	Time : 2011/04/09 - 14:15
Limit : ISN_Voltage_A_00M_QP	Margin : 0
EUT : Outdoor Bullet Network Camera	Probe : ISN_T4 - Line1
Power : AC 230V/50Hz to AC 24V	Note : Mode 2, ISN 10Mbps

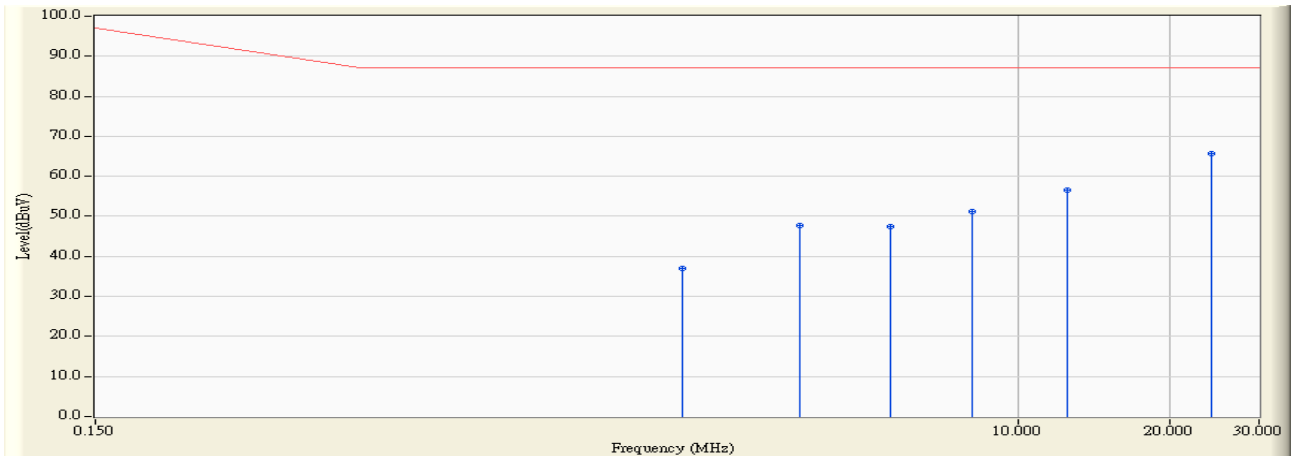

		Frequency (MHz)	Correct Factor (dB)	Reading Level (dBuV)	Measure Level (dBuV)	Margin (dB)	Limit (dBuV)	Detector Type
1		2.173	10.000	26.980	36.980	-50.020	87.000	QUASIPeAK
2		3.697	9.990	37.770	47.760	-39.240	87.000	QUASIPeAK
3		5.599	9.980	37.530	47.510	-39.490	87.000	QUASIPeAK
4		8.154	9.970	41.110	51.080	-35.920	87.000	QUASIPeAK
5		12.498	10.073	46.580	56.653	-30.347	87.000	QUASIPeAK
6	*	24.220	10.100	55.520	65.620	-21.380	87.000	QUASIPeAK

**Note:**

1. All Reading Levels are Quasi-Peak and average value.
2. " \* ", means this data is the worst emission level.
3. Measurement Level = Reading Level + Correct Factor

Site : SR_1	Time : 2011/04/09 - 14:15
Limit : ISN_Voltage_A_00M_AV	Margin : 0
EUT : Outdoor Bullet Network Camera	Probe : ISN_T4 - Line1
Power : AC 230V/50Hz to AC 24V	Note : Mode 2, ISN 10Mbps

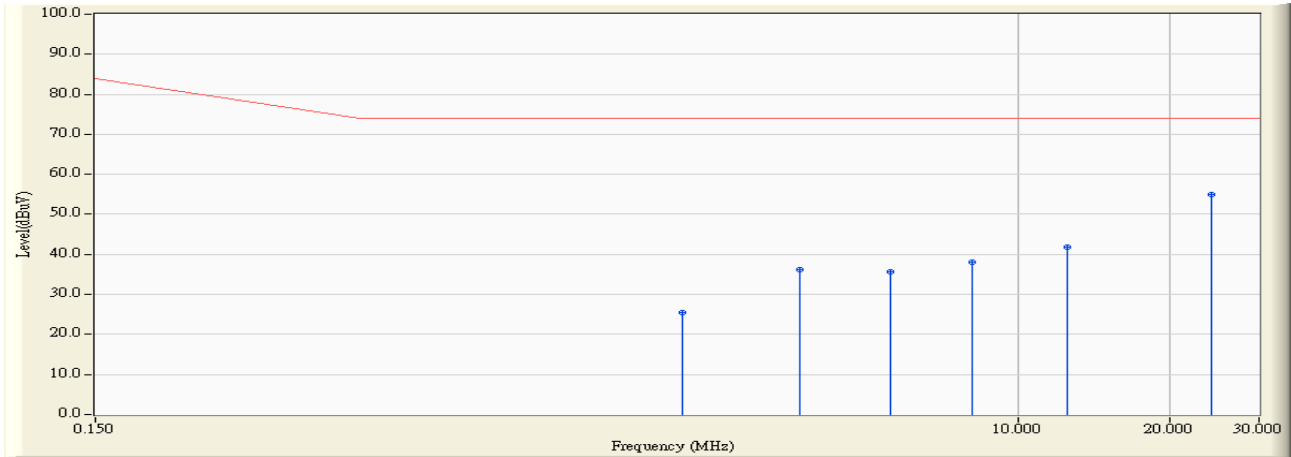

		Frequency (MHz)	Correct Factor (dB)	Reading Level (dBuV)	Measure Level (dBuV)	Margin (dB)	Limit (dBuV)	Detector Type
1		2.173	10.000	15.590	25.590	-48.410	74.000	AVERAGE
2		3.697	9.990	26.070	36.060	-37.940	74.000	AVERAGE
3		5.599	9.980	25.800	35.780	-38.220	74.000	AVERAGE
4		8.154	9.970	28.150	38.120	-35.880	74.000	AVERAGE
5		12.498	10.073	31.830	41.903	-32.097	74.000	AVERAGE
6	*	24.220	10.100	44.930	55.030	-18.970	74.000	AVERAGE

**Note:**

1. All Reading Levels are Quasi-Peak and average value.
2. " \* ", means this data is the worst emission level.
3. Measurement Level = Reading Level + Correct Factor



Site : SR_1	Time : 2011/04/09 - 14:10
Limit : ISN_Voltage_A_00M_QP	Margin : 13
EUT : Outdoor Bullet Network Camera	Probe : ISN_T4 - Line1
Power : AC 230V/50Hz to AC 24V	Note : Mode 2, ISN 100Mbps

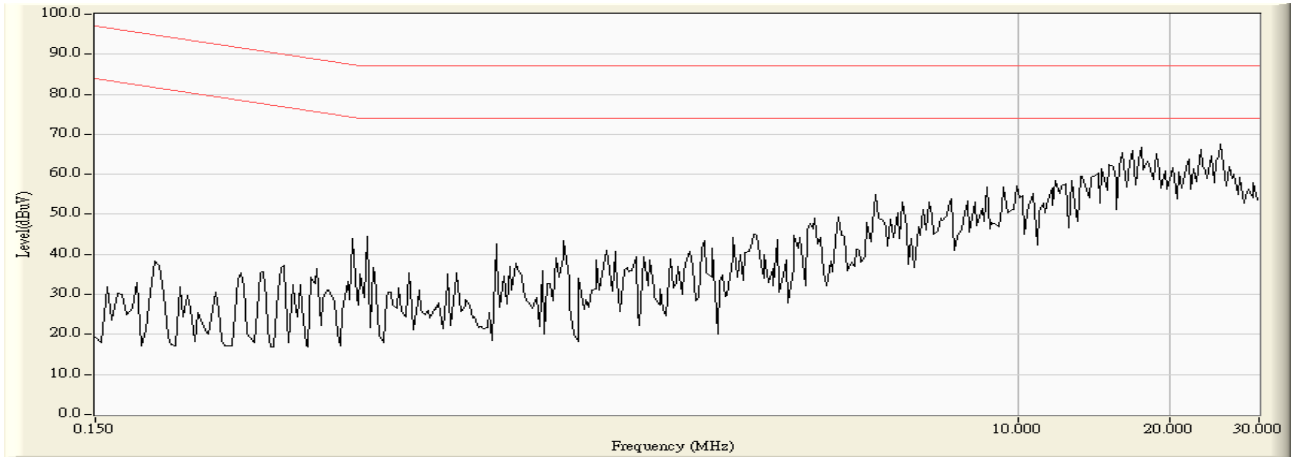

Site : SR_1	Time : 2011/04/09 - 14:12
Limit : ISN_Voltage_A_00M_QP	Margin : 0
EUT : Outdoor Bullet Network Camera	Probe : ISN_T4 - Line1
Power : AC 230V/50Hz to AC 24V	Note : Mode 2, ISN 100Mbps

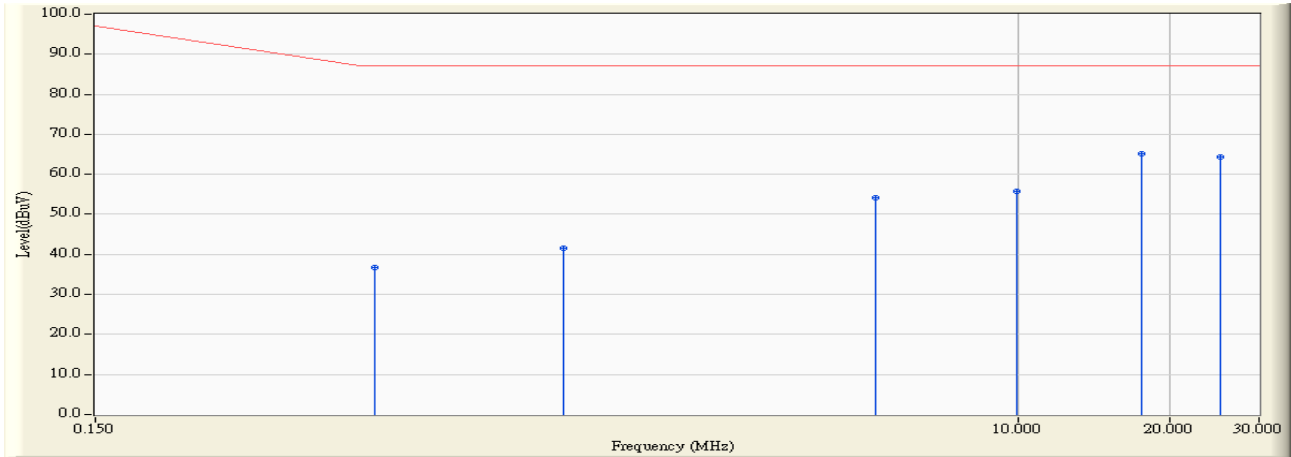

		Frequency (MHz)	Correct Factor (dB)	Reading Level (dBuV)	Measure Level (dBuV)	Margin (dB)	Limit (dBuV)	Detector Type
1		0.534	9.990	26.610	36.600	-50.400	87.000	QUASIPeAK
2		1.267	9.990	31.600	41.590	-45.410	87.000	QUASIPeAK
3		5.236	9.980	44.280	54.260	-32.740	87.000	QUASIPeAK
4		9.939	9.960	45.880	55.840	-31.160	87.000	QUASIPeAK
5	*	17.615	10.120	54.980	65.100	-21.900	87.000	QUASIPeAK
6		25.197	10.100	54.290	64.390	-22.610	87.000	QUASIPeAK

**Note:**

1. All Reading Levels are Quasi-Peak and average value.
2. " \* ", means this data is the worst emission level.
3. Measurement Level = Reading Level + Correct Factor

Site : SR_1	Time : 2011/04/09 - 14:12
Limit : ISN_Voltage_A_00M_AV	Margin : 0
EUT : Outdoor Bullet Network Camera	Probe : ISN_T4 - Line1
Power : AC 230V/50Hz to AC 24V	Note : Mode 2, ISN 100Mbps

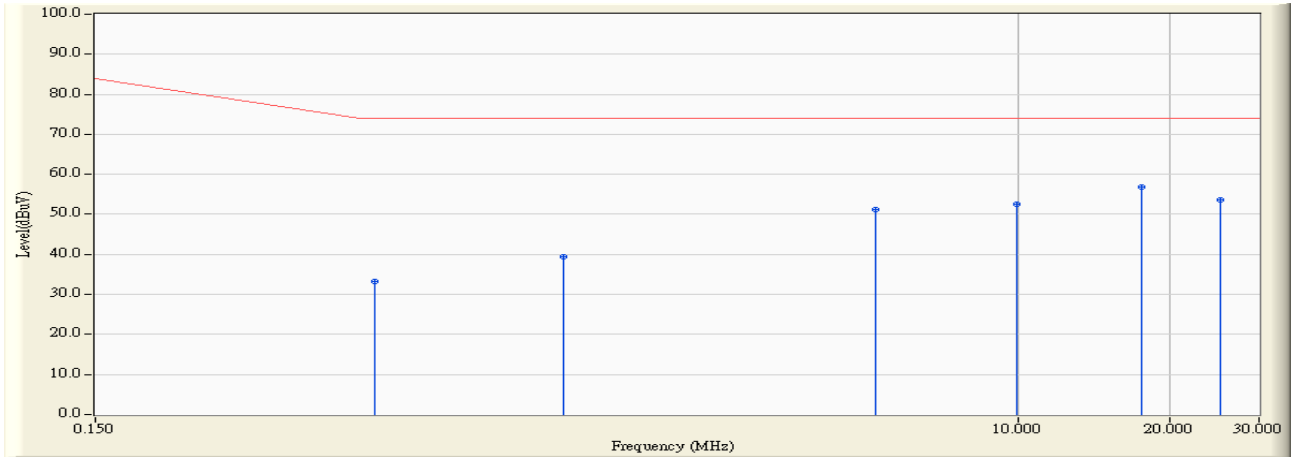

		Frequency (MHz)	Correct Factor (dB)	Reading Level (dBuV)	Measure Level (dBuV)	Margin (dB)	Limit (dBuV)	Detector Type
1		0.534	9.990	23.260	33.250	-40.750	74.000	AVERAGE
2		1.267	9.990	29.380	39.370	-34.630	74.000	AVERAGE
3		5.236	9.980	41.140	51.120	-22.880	74.000	AVERAGE
4		9.939	9.960	42.710	52.670	-21.330	74.000	AVERAGE
5	*	17.615	10.120	46.740	56.860	-17.140	74.000	AVERAGE
6		25.197	10.100	43.510	53.610	-20.390	74.000	AVERAGE

**Note:**

1. All Reading Levels are Quasi-Peak and average value.
2. " \* ", means this data is the worst emission level.
3. Measurement Level = Reading Level + Correct Factor

Site : SR-1	Time : 2011/04/12 - 20:51
Limit : ISN_Voltage_A_00M_QP	Margin : 10
Probe : TESEQ_T8 - Line1	Power : AC 230V/50Hz
EUT : Outdoor Bullet Network Camera	Note : Mode 3, ISN 10Mbps

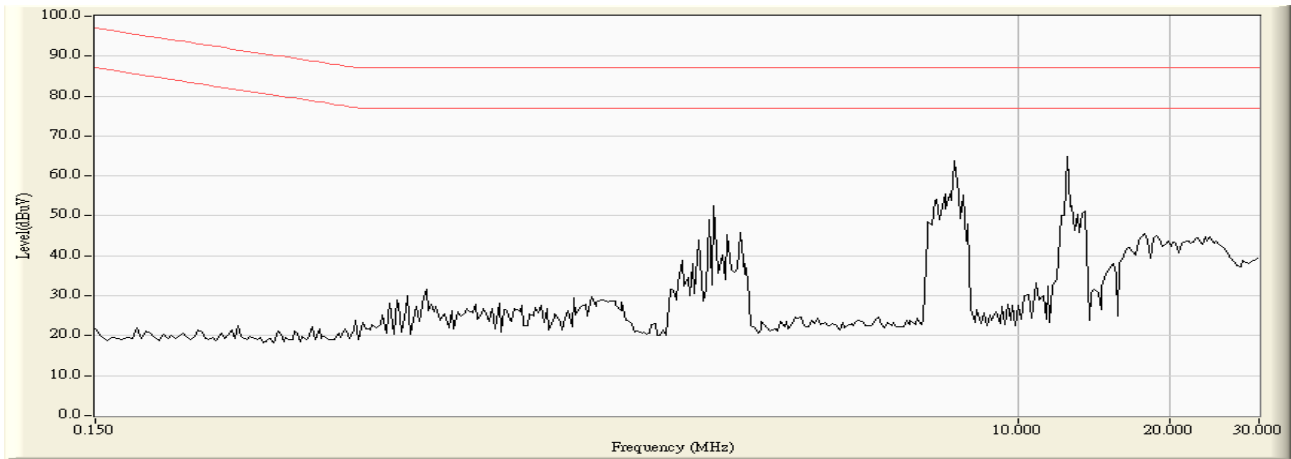

Site : SR-1	Time : 2011/04/12 - 20:55
Limit : ISN_Voltage_A_00M_QP	Margin : 0
Probe : TESEQ_T8 - Line1	Power : AC 230V/50Hz
EUT : Outdoor Bullet Network Camera	Note : Mode 3, ISN 10Mbps

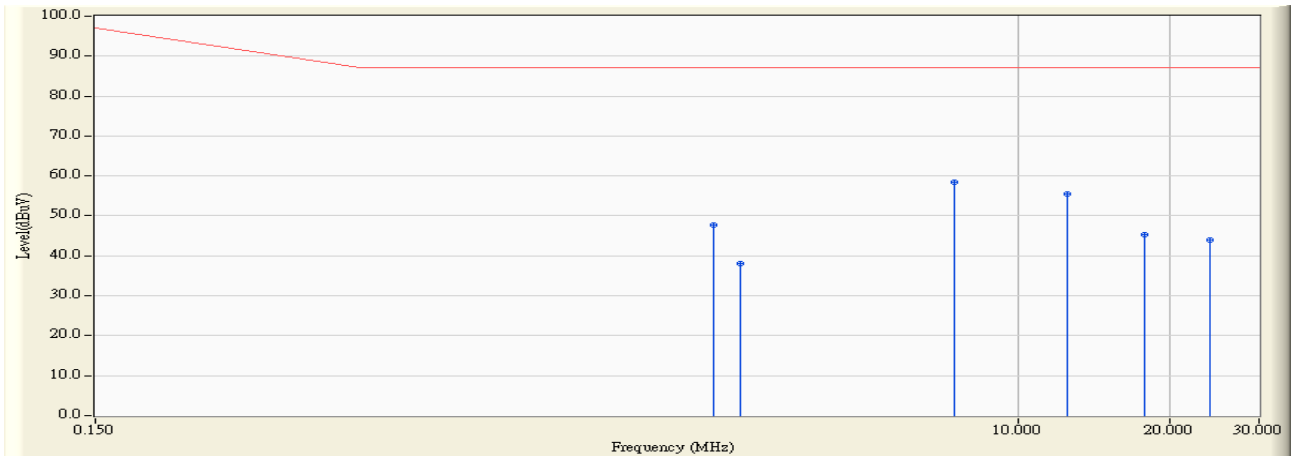

		Frequency (MHz)	Correct Factor (dB)	Reading Level (dBμV)	Measure Level (dBμV)	Margin (dB)	Limit (dBμV)	Detector Type
1		2.502	10.040	37.570	47.610	-39.390	87.000	QUASPEAK
2		2.826	10.040	28.010	38.050	-48.950	87.000	QUASPEAK
3	*	7.502	10.063	48.250	58.313	-28.687	87.000	QUASPEAK
4		12.502	10.128	45.320	55.448	-31.552	87.000	QUASPEAK
5		17.857	10.180	35.020	45.200	-41.800	87.000	QUASPEAK
6		23.974	10.240	33.760	44.000	-43.000	87.000	QUASPEAK

**Note:**

1. All Reading Levels are Quasi-Peak and average value.
2. " \* ", means this data is the worst emission level.
3. Measurement Level = Reading Level + Correct Factor.

Site : SR-1	Time : 2011/04/12 - 20:55
Limit : ISN_Voltage_A_00M_AV	Margin : 0
Probe : TESEQ_T8 - Line1	Power : AC 230V/50Hz
EUT : Outdoor Bullet Network Camera	Note : Mode 3, ISN 10Mbps

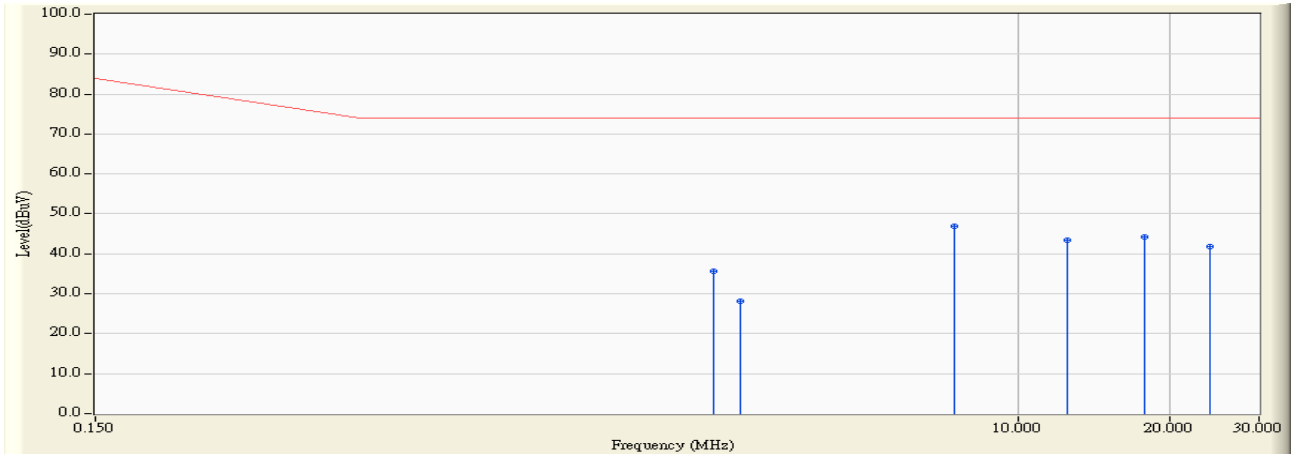

		Frequency (MHz)	Correct Factor (dB)	Reading Level (dBμV)	Measure Level (dBμV)	Margin (dB)	Limit (dBμV)	Detector Type
1		2.502	10.040	25.580	35.620	-38.380	74.000	AVERAGE
2		2.826	10.040	18.130	28.170	-45.830	74.000	AVERAGE
3	*	7.502	10.063	36.910	46.973	-27.027	74.000	AVERAGE
4		12.502	10.128	33.270	43.398	-30.602	74.000	AVERAGE
5		17.857	10.180	33.960	44.140	-29.860	74.000	AVERAGE
6		23.974	10.240	31.550	41.790	-32.210	74.000	AVERAGE

**Note:**

1. All Reading Levels are Quasi-Peak and average value.
2. " \* ", means this data is the worst emission level.
3. Measurement Level = Reading Level + Correct Factor.

Site : SR-1	Time : 2011/04/12 - 20:46
Limit : ISN_Voltage_A_00M_QP	Margin : 10
Probe : TESEQ_T8 - Line1	Power : AC 230V/50Hz
EUT : Outdoor Bullet Network Camera	Note : Mode 3, ISN 100Mbps

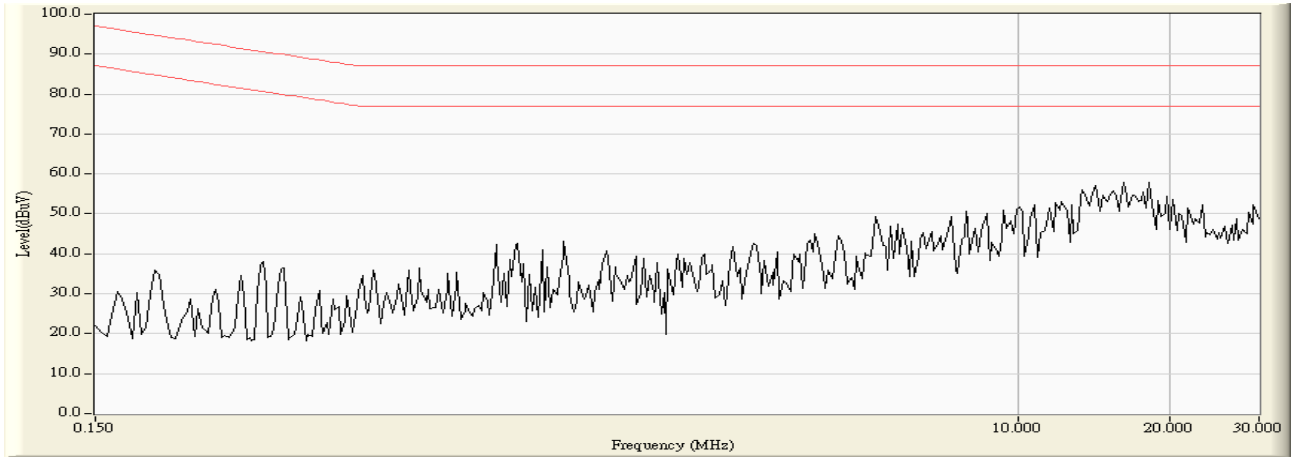

Site : SR-1	Time : 2011/04/12 - 20:48
Limit : ISN_Voltage_A_00M_QP	Margin : 0
Probe : TESEQ_T8 - Line1	Power : AC 230V/50Hz
EUT : Outdoor Bullet Network Camera	Note : Mode 3, ISN 100Mbps

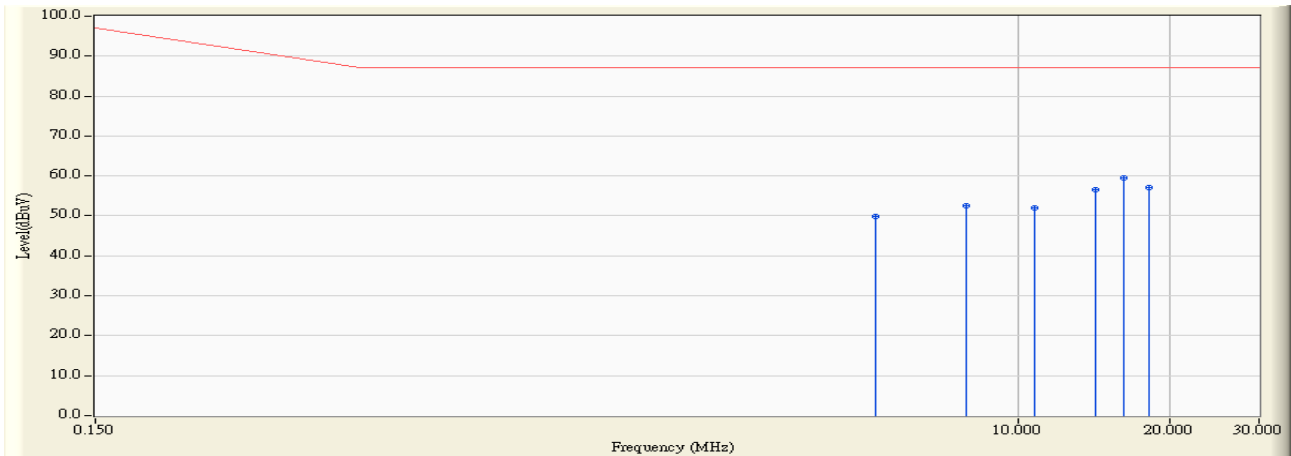

		Frequency (MHz)	Correct Factor (dB)	Reading Level (dBμV)	Measure Level (dBμV)	Margin (dB)	Limit (dBμV)	Detector Type
1		5.236	10.030	39.890	49.920	-37.080	87.000	QUASPEAK
2		7.923	10.070	42.570	52.640	-34.360	87.000	QUASPEAK
3		10.795	10.110	41.900	52.010	-34.990	87.000	QUASPEAK
4		14.213	10.140	46.430	56.570	-30.430	87.000	QUASPEAK
5	*	16.228	10.160	49.230	59.390	-27.610	87.000	QUASPEAK
6		18.244	10.180	47.050	57.230	-29.770	87.000	QUASPEAK

**Note:**

1. All Reading Levels are Quasi-Peak and average value.
2. " \* ", means this data is the worst emission level.
3. Measurement Level = Reading Level + Correct Factor.



Site : SR-1	Time : 2011/04/12 - 20:48
Limit : ISN_Voltage_A_00M_AV	Margin : 0
Probe : TESEQ_T8 - Line1	Power : AC 230V/50Hz
EUT : Outdoor Bullet Network Camera	Note : Mode 3, ISN 100Mbps

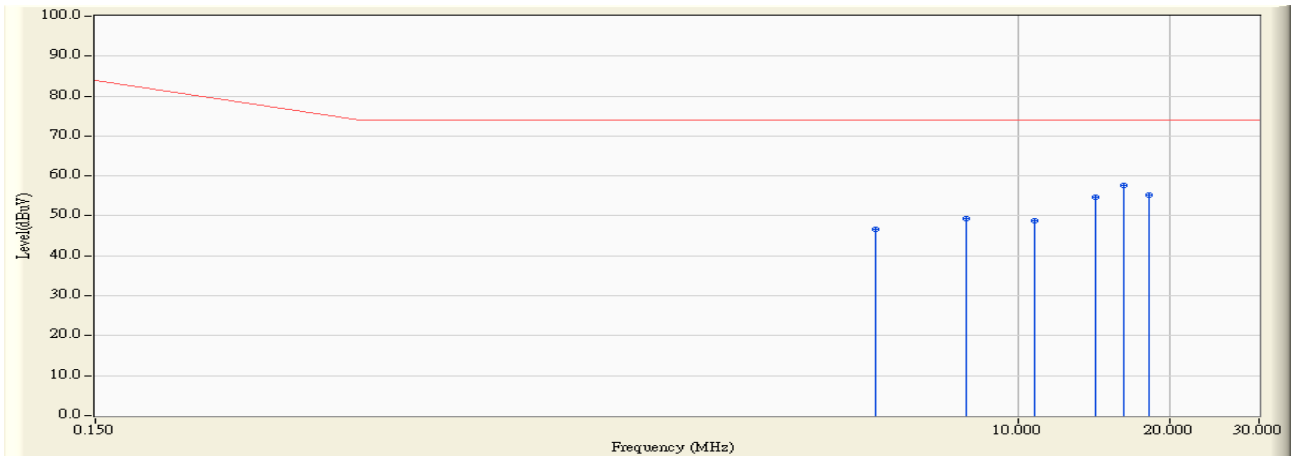

		Frequency (MHz)	Correct Factor (dB)	Reading Level (dBμV)	Measure Level (dBμV)	Margin (dB)	Limit (dBμV)	Detector Type
1		5.236	10.030	36.710	46.740	-27.260	74.000	AVERAGE
2		7.923	10.070	39.380	49.450	-24.550	74.000	AVERAGE
3		10.795	10.110	38.790	48.900	-25.100	74.000	AVERAGE
4		14.213	10.140	44.420	54.560	-19.440	74.000	AVERAGE
5	*	16.228	10.160	47.370	57.530	-16.470	74.000	AVERAGE
6		18.244	10.180	45.020	55.200	-18.800	74.000	AVERAGE

**Note:**

1. All Reading Levels are Quasi-Peak and average value.
2. " \* ", means this data is the worst emission level.
3. Measurement Level = Reading Level + Correct Factor.

## 4.7. Test Photograph

Test Mode : Mode 1: Normal Operation (DC 12V)

Description : Front View of ISN Test



Test Mode : Mode 1: Normal Operation (DC 12V)

Description : Back View of ISN Test



Test Mode : Mode 2: Normal Operation (AC 24V)

Description : Front View of ISN Test



Test Mode : Mode 2: Normal Operation (AC 24V)

Description : Back View of ISN Test



Test Mode : Mode 3: Normal Operation (PoE)

Description : Front View of ISN Test



Test Mode : Mode 3: Normal Operation (PoE)

Description : Back View of ISN Test



## 5. Radiated Emission

### 5.1. Test Specification

According to EMC Standard : EN 55022 and AS/NZS CISPR 22

### 5.2. Test Setup

Under 1GHz Test Setup:

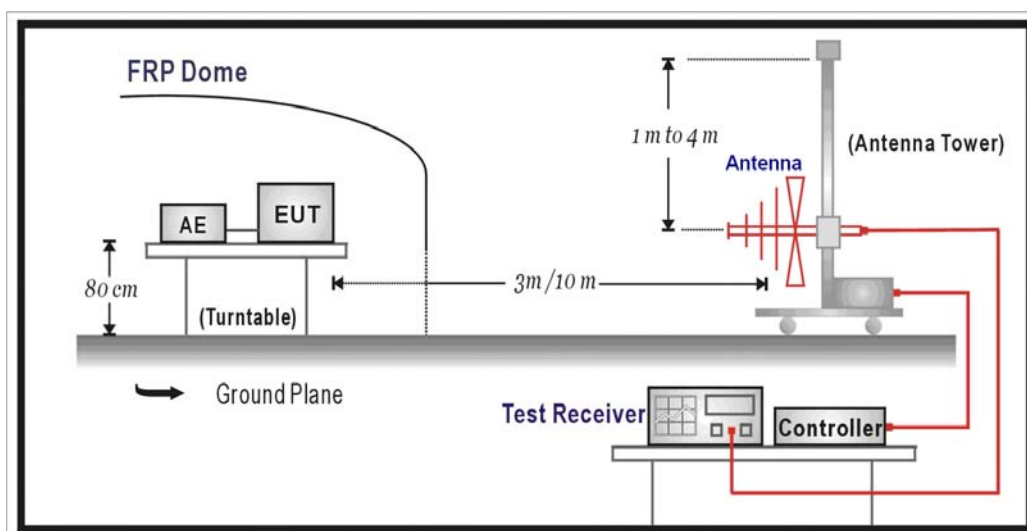

Above 1GHz Test Setup:

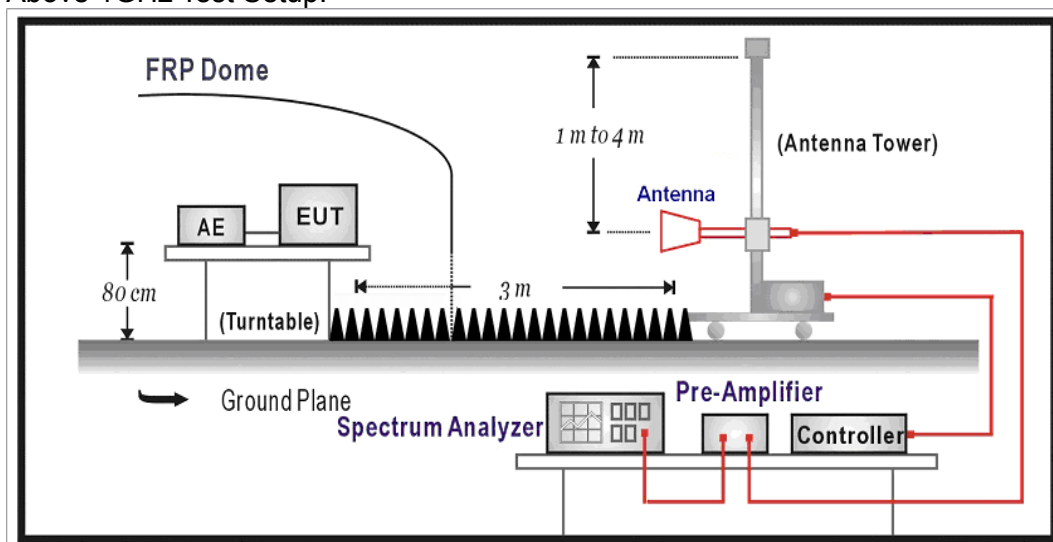

**5.3. Limit**

Limits		
Frequency MHz	Distance (m)	dBuV/m
30 – 230	10	40
230 – 1000	10	47

Limits			
Frequency (GHz)	Distance (m)	Peak (dBuV/m)	Average (dBuV/m)
1 – 3	3	76	56
3 – 6	3	80	60

Remark:

1. The tighter limit shall apply at the edge between two frequency bands.
2. Distance refers to the distance in meters between the measuring instrument antenna and the closed point of any part of the device or system.

Highest frequency generated or used in the device or on which the device operates or tunes (MHz)	Upper frequency of measurement range (MHz)
Below 108	1000
108 – 500	2000
500 – 1000	5000
Above 1000	5 <sup>th</sup> harmonic of the highest frequency or 6 GHz, whichever is lower

#### **5.4. Test Procedure**

The EUT and its simulators are placed on a turn table which is 0.8 meter above ground. The turn table can rotate 360 degrees to determine the position of the maximum emission level. The EUT was positioned such that the distance from antenna to the EUT was 3/10 meters. The antenna can move up and down between 1 meter and 4 meters to find out the maximum emission level.

Both horizontal and vertical polarization of the antenna are set on measurement. In order to find the maximum emission, all of the interface cables must be manipulated on radiated measurement.

Radiated emissions were investigated over the frequency range from 30MHz to 1GHz using a receiver bandwidth of 120kHz and above 1GHz using a receiver bandwidth of 1MHz.

30MHz to 1GHz Radiated was performed at an antenna to EUT distance of 10 meters.

Above 1GHz Radiated was performed at an antenna to EUT distance of 3 meters.

It is placed with absorb on the ground between EUT and Antenna.

#### **5.5. Deviation from Test Standard**

No deviation.

5.6. Test Result

Site : OATS 4	Time : 2011/04/01 - 13:14
Limit : CISPR_A_10M_QP	Margin : 6
EUT : Outdoor Bullet Network Camera	Probe : Site4_CBL6112_10M_0811 - HORIZONTAL
Power : AC 230V/50Hz	Note : Mode 1

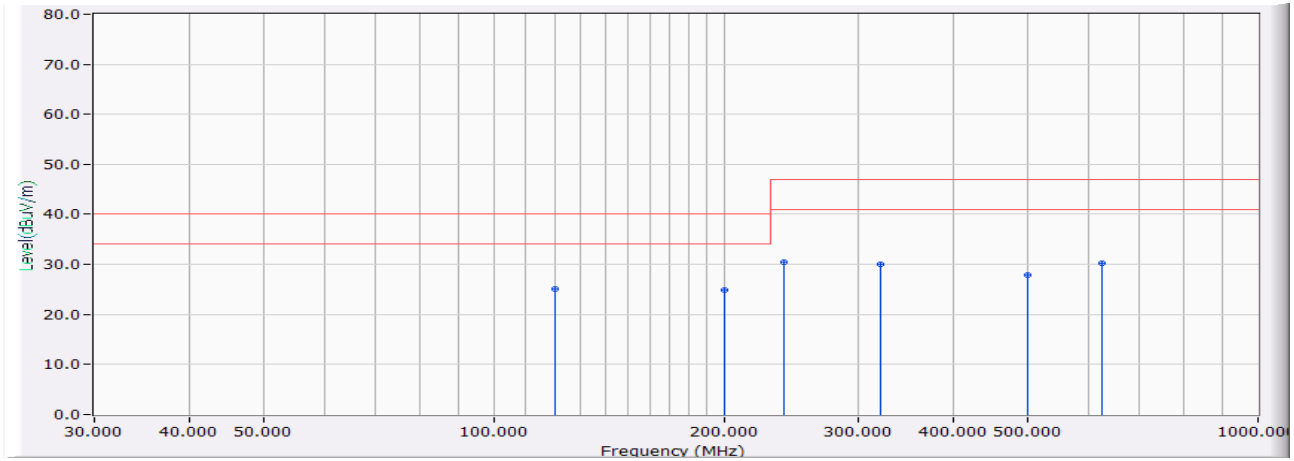

		Frequency (MHz)	Correct Factor (dB)	Reading Level (dBuV)	Measure Level (dBuV/m)	Margin (dB)	Limit (dBuV/m)	Detector Type
1	*	120.000	15.111	10.000	25.111	-14.889	40.000	QUASIPeAK
2		200.000	12.543	12.400	24.943	-15.057	40.000	QUASIPeAK
3		240.000	15.385	15.000	30.385	-16.615	47.000	QUASIPeAK
4		320.000	18.019	12.100	30.119	-16.881	47.000	QUASIPeAK
5		500.015	22.081	5.900	27.981	-19.019	47.000	QUASIPeAK
6		625.022	24.244	6.000	30.244	-16.756	47.000	QUASIPeAK

Note:

1. All Readings below 1GHz are Quasi-Peak, above are performed with peak and/or average measurements as necessary.
2. " \* ", means this data is the worst emission level.
3. Measurement Level = Reading Level + Correct Factor



Site : OATS 4	Time : 2011/04/01 - 12:59
Limit : CISPR_A_10M_QP	Margin : 6
EUT : Outdoor Bullet Network Camera	Probe : Site4_CBL6112_10M_0811 - VERTICAL
Power : AC 230V/50Hz	Note : Mode 1

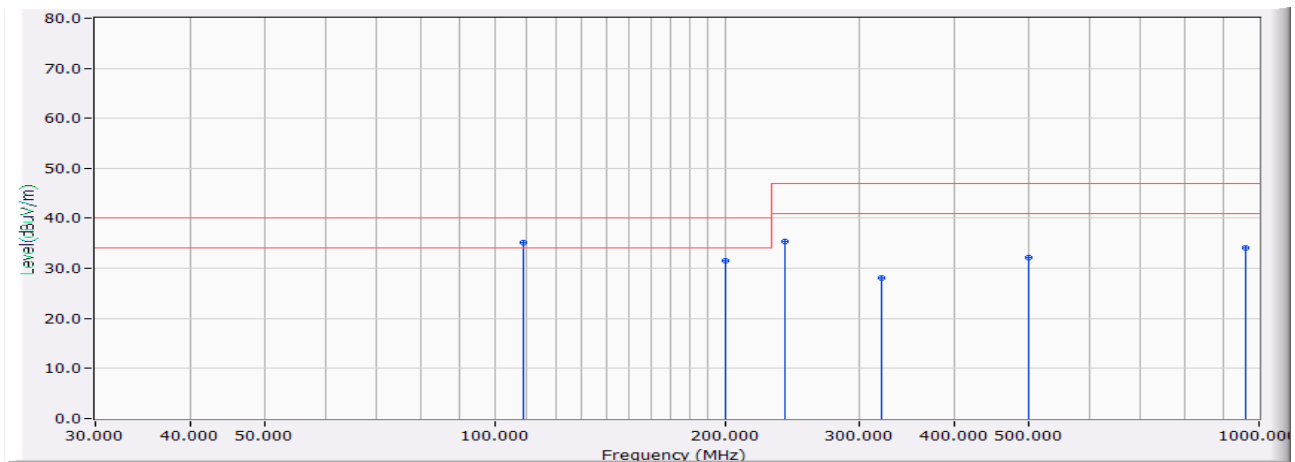

		Frequency (MHz)	Correct Factor (dB)	Reading Level (dBuV)	Measure Level (dBuV/m)	Margin (dB)	Limit (dBuV/m)	Detector Type
1	*	108.800	13.593	21.600	35.193	-4.807	40.000	QUASIPeAK
2		200.000	12.543	19.000	31.543	-8.457	40.000	QUASIPeAK
3		240.000	15.385	20.000	35.385	-11.615	47.000	QUASIPeAK
4		320.000	18.019	10.000	28.019	-18.981	47.000	QUASIPeAK
5		500.015	22.081	10.000	32.081	-14.919	47.000	QUASIPeAK
6		960.000	29.043	5.000	34.043	-12.957	47.000	QUASIPeAK

**Note:**

1. All Readings below 1GHz are Quasi-Peak, above are performed with peak and/or average measurements as necessary.
2. " \* ", means this data is the worst emission level.
3. Measurement Level = Reading Level + Correct Factor

Site : OATS 4	Time : 2011/04/06 - 19:20
Limit : CISPR_A_10M_QP	Margin : 6
EUT : Outdoor Bullet Network Camera	Probe : Site4_CBL6112_10M_0811 - HORIZONTAL
Power : AC 230V/50Hz	Note : Mode 2

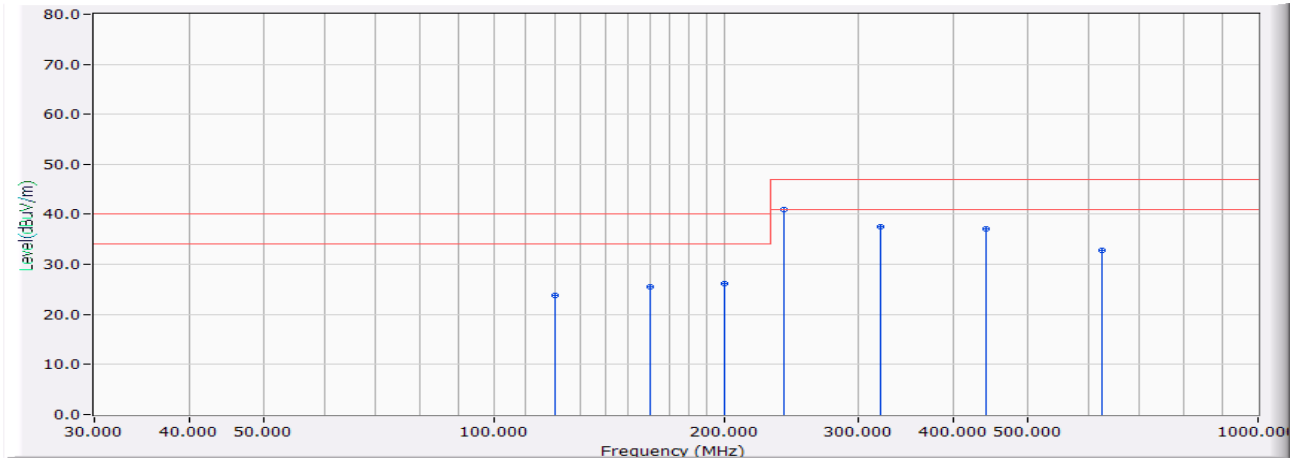

	Frequency (MHz)	Correct Factor (dB)	Reading Level (dBuV)	Measure Level (dBuV/m)	Margin (dB)	Limit (dBuV/m)	Detector Type
1	120.000	15.111	8.800	23.911	-16.089	40.000	QUASIPeAK
2	160.000	13.209	12.400	25.609	-14.391	40.000	QUASIPeAK
3	200.000	12.543	13.600	26.143	-13.857	40.000	QUASIPeAK
4	* 240.000	15.385	25.500	40.885	-6.115	47.000	QUASIPeAK
5	320.000	18.019	19.600	37.619	-9.381	47.000	QUASIPeAK
6	440.000	20.981	16.100	37.080	-9.920	47.000	QUASIPeAK
7	625.000	24.244	8.600	32.844	-14.156	47.000	QUASIPeAK

**Note:**

1. All Readings below 1GHz are Quasi-Peak, above are performed with peak and/or average measurements as necessary.
2. " \* ", means this data is the worst emission level.
3. Measurement Level = Reading Level + Correct Factor

Site : OATS 4	Time : 2011/04/06 - 19:00
Limit : CISPR_A_10M_QP	Margin : 6
EUT : Outdoor Bullet Network Camera	Probe : Site4_CBL6112_10M_0811 - VERTICAL
Power : AC 230V/50Hz	Note : Mode 2

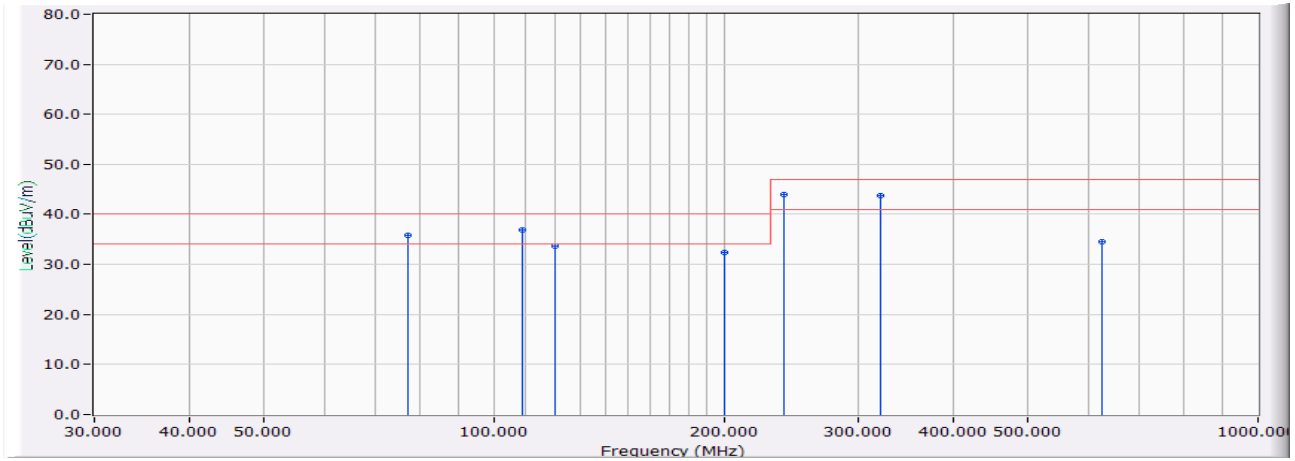

		Frequency (MHz)	Correct Factor (dB)	Reading Level (dBuV)	Measure Level (dBuV/m)	Margin (dB)	Limit (dBuV/m)	Detector Type
1		77.256	10.119	25.700	35.819	-4.181	40.000	QUASIPeAK
2		108.803	13.593	23.200	36.793	-3.207	40.000	QUASIPeAK
3		120.007	15.111	18.600	33.711	-6.289	40.000	QUASIPeAK
4		200.000	12.543	19.800	32.343	-7.657	40.000	QUASIPeAK
5	*	240.000	15.385	28.500	43.885	-3.115	47.000	QUASIPeAK
6		320.000	18.019	25.800	43.819	-3.181	47.000	QUASIPeAK
7		625.000	24.244	10.200	34.444	-12.556	47.000	QUASIPeAK

**Note:**

1. All Readings below 1GHz are Quasi-Peak, above are performed with peak and/or average measurements as necessary.
2. " \* ", means this data is the worst emission level.
3. Measurement Level = Reading Level + Correct Factor

Site : OATS 4	Time : 2011/04/01 - 13:32
Limit : CISPR_A_10M_QP	Margin : 6
EUT : Outdoor Bullet Network Camera	Probe : Site4_CBL6112_10M_0811 - HORIZONTAL
Power : AC 230V/50Hz	Note : Mode 3

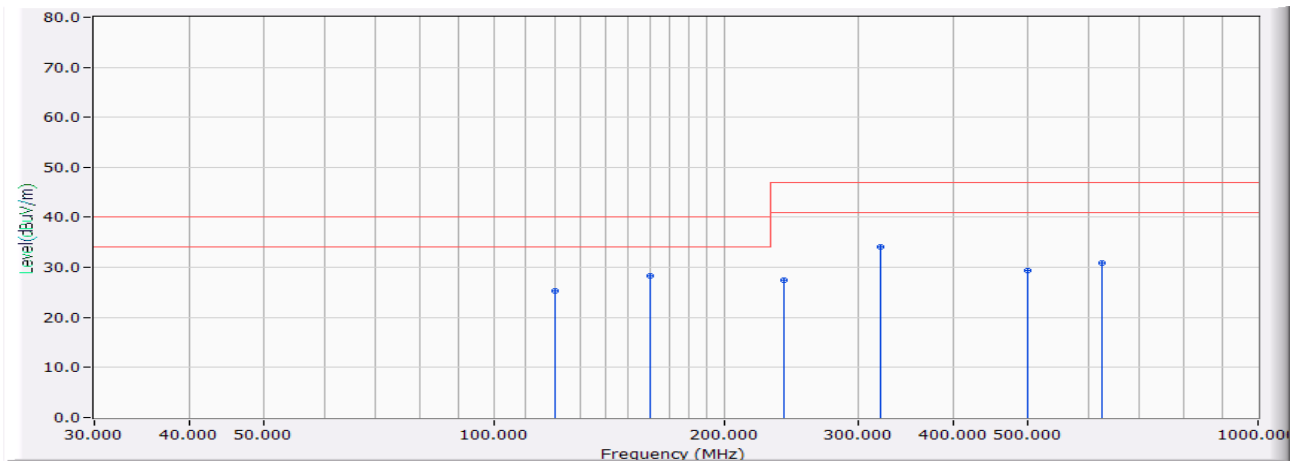

		Frequency (MHz)	Correct Factor (dB)	Reading Level (dBuV)	Measure Level (dBuV/m)	Margin (dB)	Limit (dBuV/m)	Detector Type
1		120.000	15.111	10.200	25.311	-14.689	40.000	QUASIPeAK
2	*	160.000	13.209	15.200	28.409	-11.591	40.000	QUASIPeAK
3		240.000	15.385	12.000	27.385	-19.615	47.000	QUASIPeAK
4		320.000	18.019	16.000	34.019	-12.981	47.000	QUASIPeAK
5		500.000	22.081	7.400	29.481	-17.519	47.000	QUASIPeAK
6		625.020	24.244	6.700	30.944	-16.056	47.000	QUASIPeAK

**Note:**

1. All Readings below 1GHz are Quasi-Peak, above are performed with peak and/or average measurements as necessary.
2. " \* ", means this data is the worst emission level.
3. Measurement Level = Reading Level + Correct Factor

Site : OATS 4	Time : 2011/04/01 - 13:45
Limit : CISPR_A_10M_QP	Margin : 6
EUT : Outdoor Bullet Network Camera	Probe : Site4_CBL6112_10M_0811 - VERTICAL
Power : AC 230V/50Hz	Note : Mode 3

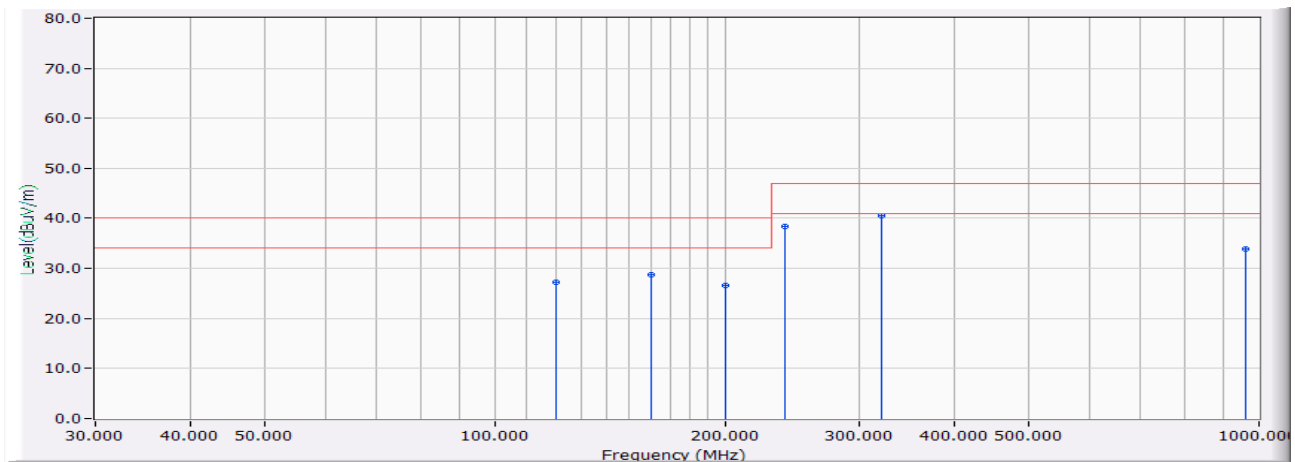

	Frequency (MHz)	Correct Factor (dB)	Reading Level (dBuV)	Measure Level (dBuV/m)	Margin (dB)	Limit (dBuV/m)	Detector Type
1	120.000	15.111	12.200	27.311	-12.689	40.000	QUASIPeAK
2	160.000	13.209	15.600	28.809	-11.191	40.000	QUASIPeAK
3	200.000	12.543	14.000	26.543	-13.457	40.000	QUASIPeAK
4	240.000	15.385	22.900	38.285	-8.715	47.000	QUASIPeAK
5	* 320.000	18.019	22.500	40.519	-6.481	47.000	QUASIPeAK
6	960.000	29.043	4.900	33.943	-13.057	47.000	QUASIPeAK

**Note:**

1. All Readings below 1GHz are Quasi-Peak, above are performed with peak and/or average measurements as necessary.
2. " \* ", means this data is the worst emission level.
3. Measurement Level = Reading Level + Correct Factor

Site: 9x6x6_Chamber	Time: 2011/04/09 - 11:05
Limit: EN55022_A_(Above_1G)	Margin: 0
Probe: 9120D_1-18G_Horn	Polarity: Horizontal
EUT: Outdoor Bullet Network Camera	Power: AC 230V/50Hz
Note: Mode 1	

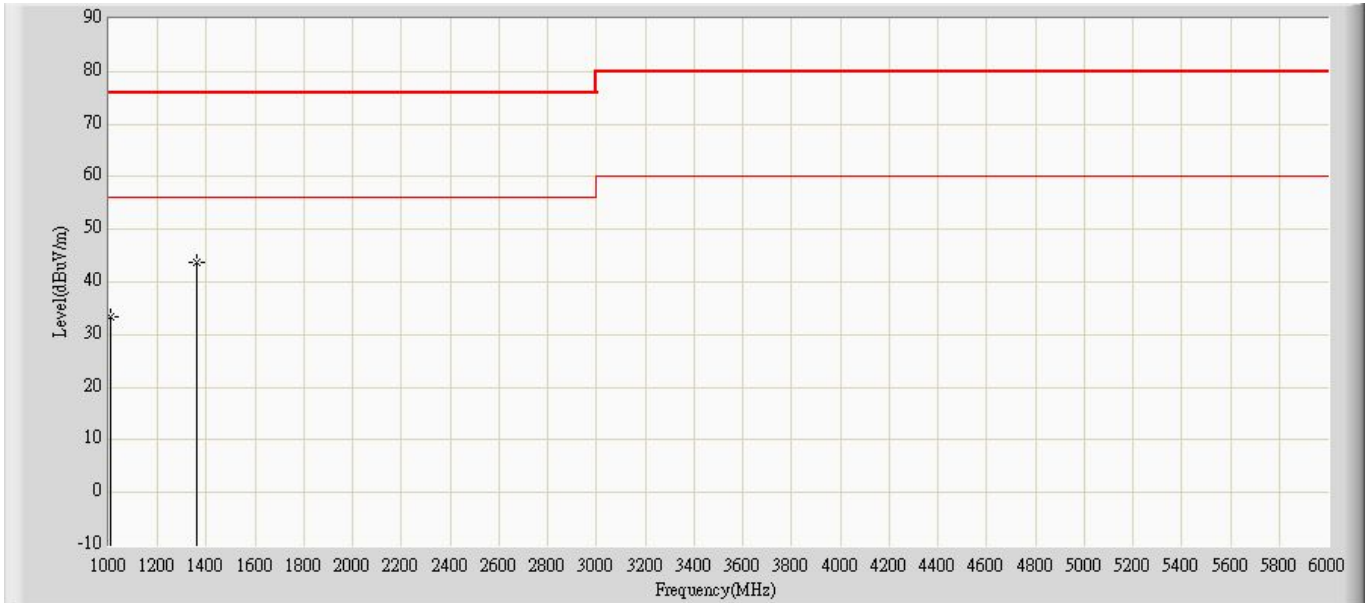

		Frequency (MHz)	Measure Level (dBuV/m)	Reading Level (dBuV)	Over Limit (dB)	Limit (dBuV/m)	Factor	Type
1		1009.000	33.383	41.630	-42.617	76.000	-8.247	PK
2	*	1359.000	43.832	51.030	-32.168	76.000	-7.197	PK

**Note:**

1. All Readings below 1GHz are Quasi-Peak, above are performed with peak and/or average measurements as necessary.
2. " \* ", means this data is the worst emission level.
3. Measurement Level = Reading Level + Factor(Probe+Cable-Amp).

Site: 9x6x6_Chamber	Time: 2011/04/09 - 11:06
Limit: EN55022_A_(Above_1G)	Margin: 0
Probe: 9120D_1-18G_Horn	Polarity: Vertical
EUT: Outdoor Bullet Network Camera	Power: AC 230V/50Hz
Note: Mode 1	

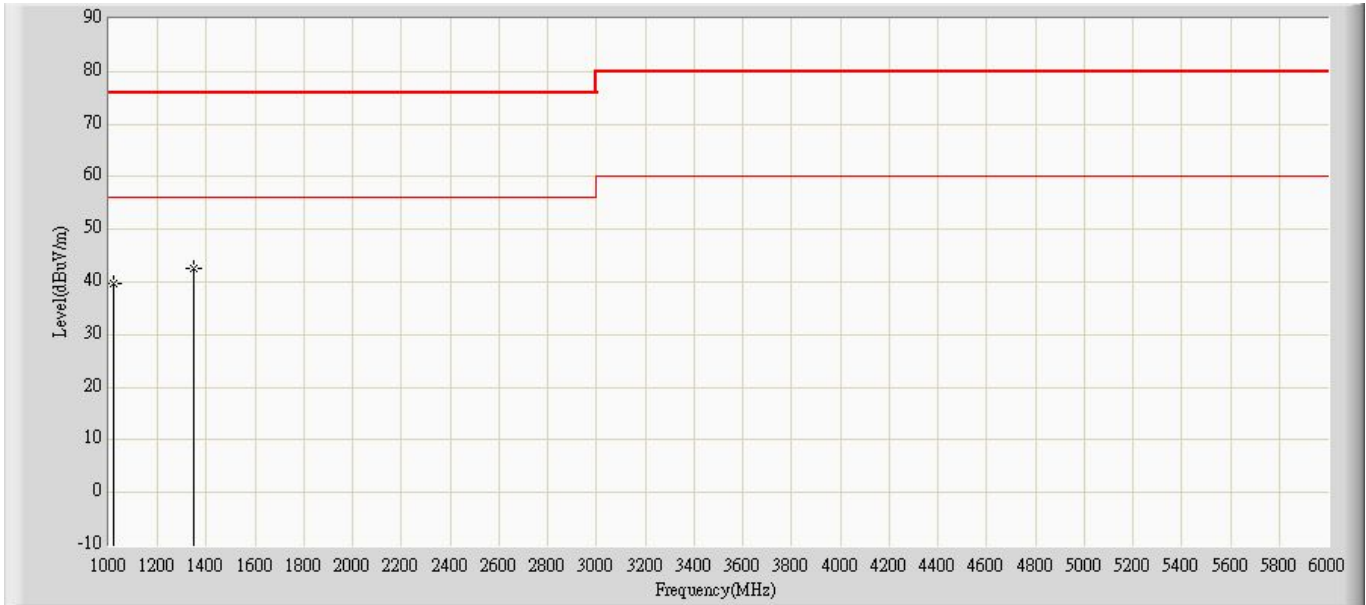

		Frequency (MHz)	Measure Level (dBuV/m)	Reading Level (dBuV)	Over Limit (dB)	Limit (dBuV/m)	Factor	Type
1		1019.000	39.766	48.010	-36.234	76.000	-8.244	PK
2	*	1349.000	42.576	49.870	-33.424	76.000	-7.294	PK

**Note:**

1. All Readings below 1GHz are Quasi-Peak, above are performed with peak and/or average measurements as necessary.
2. " \* ", means this data is the worst emission level.
3. Measurement Level = Reading Level + Factor(Probe+Cable-Amp).

Site: 9x6x6_Chamber	Time: 2011/04/09 - 11:25
Limit: EN55022_A_(Above_1G)	Margin: 0
Probe: 9120D_1-18G_Horn	Polarity: Horizontal
EUT: Outdoor Bullet Network Camera	Power: AC 230V/50Hz
Note: Mode 2	

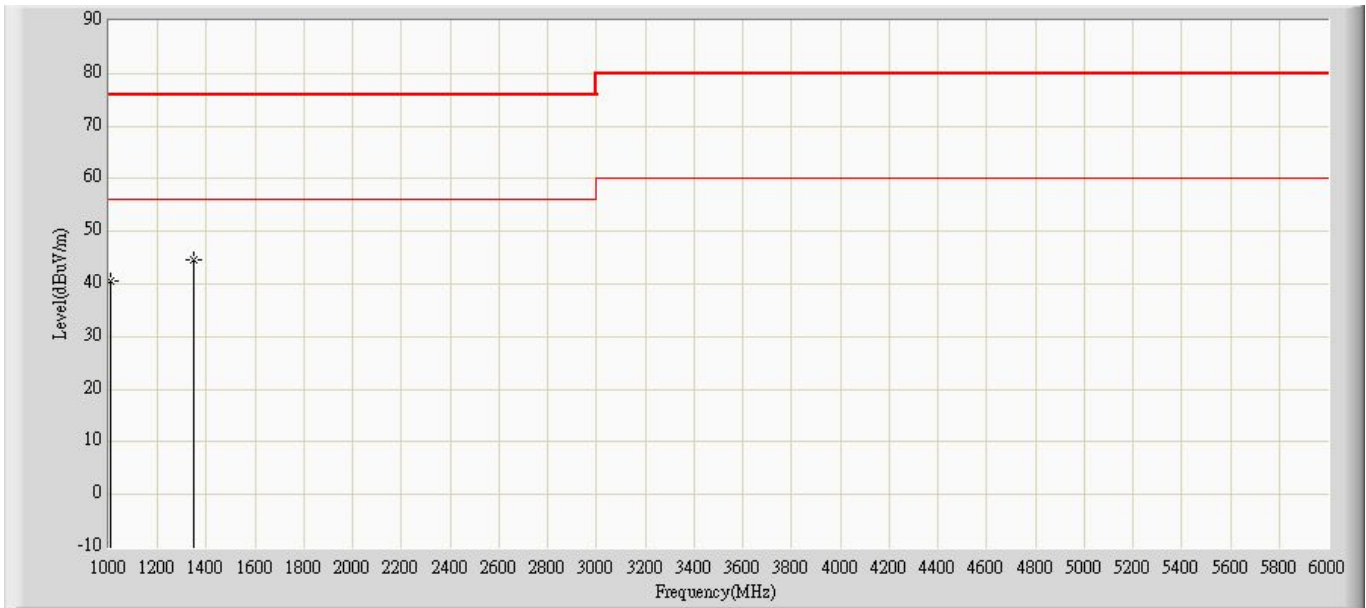

		Frequency (MHz)	Measure Level (dBuV/m)	Reading Level (dBuV)	Over Limit (dB)	Limit (dBuV/m)	Factor	Type
1		1009.000	40.703	48.950	-35.297	76.000	-8.247	PK
2	*	1349.000	44.556	51.850	-31.444	76.000	-7.294	PK

**Note:**

1. All Readings below 1GHz are Quasi-Peak, above are performed with peak and/or average measurements as necessary.
2. " \* ", means this data is the worst emission level.
3. Measurement Level = Reading Level + Factor(Probe+Cable-Amp).



Site: 9x6x6_Chamber	Time: 2011/04/09 - 11:26
Limit: EN55022_A_(Above_1G)	Margin: 0
Probe: 9120D_1-18G_Horn	Polarity: Vertical
EUT: Outdoor Bullet Network Camera	Power: AC 230V/50Hz
Note: Mode 2	

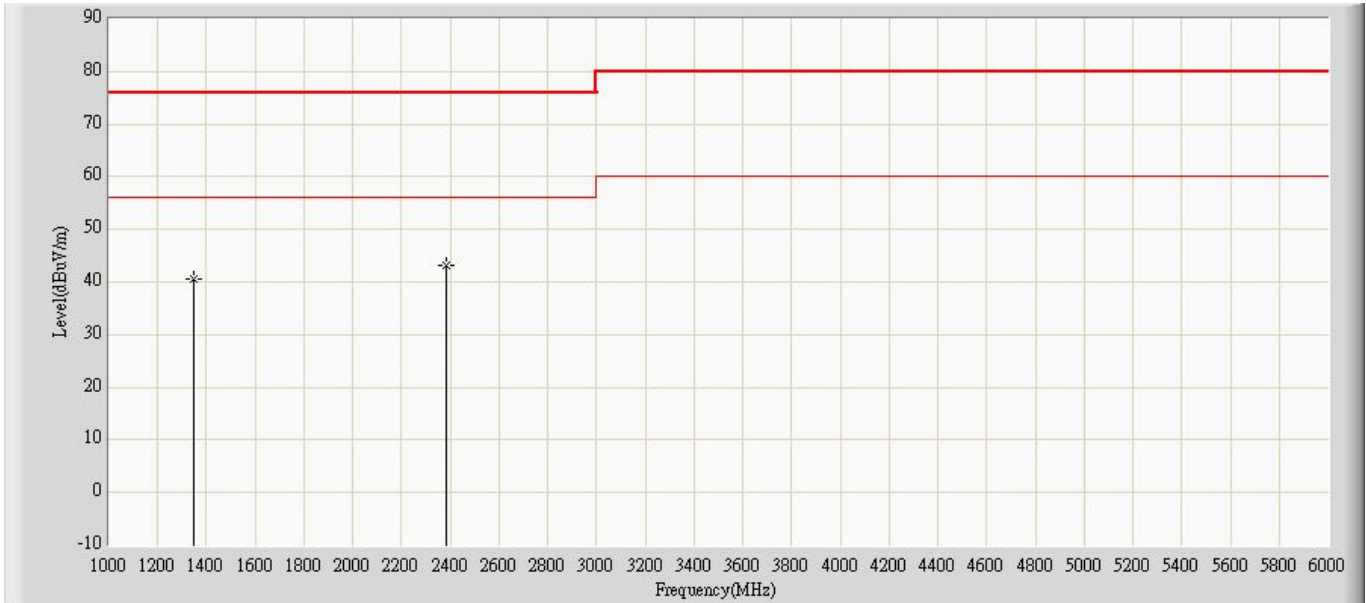

	Frequency (MHz)	Measure Level (dBuV/m)	Reading Level (dBuV)	Over Limit (dB)	Limit (dBuV/m)	Factor	Type
1	1349.000	40.596	47.890	-35.404	76.000	-7.294	PK
2	* 2381.000	43.112	47.890	-32.888	76.000	-4.777	PK

**Note:**

1. All Readings below 1GHz are Quasi-Peak, above are performed with peak and/or average measurements as necessary.
2. " \* ", means this data is the worst emission level.
3. Measurement Level = Reading Level + Factor(Probe+Cable-Amp).

Site: 9x6x6_Chamber	Time: 2011/04/09 - 11:50
Limit: EN55022_A_(Above_1G)	Margin: 0
Probe: 9120D_1-18G_Horn	Polarity: Horizontal
EUT: Outdoor Bullet Network Camera	Power: AC 230V/50Hz
Note: Mode 3	

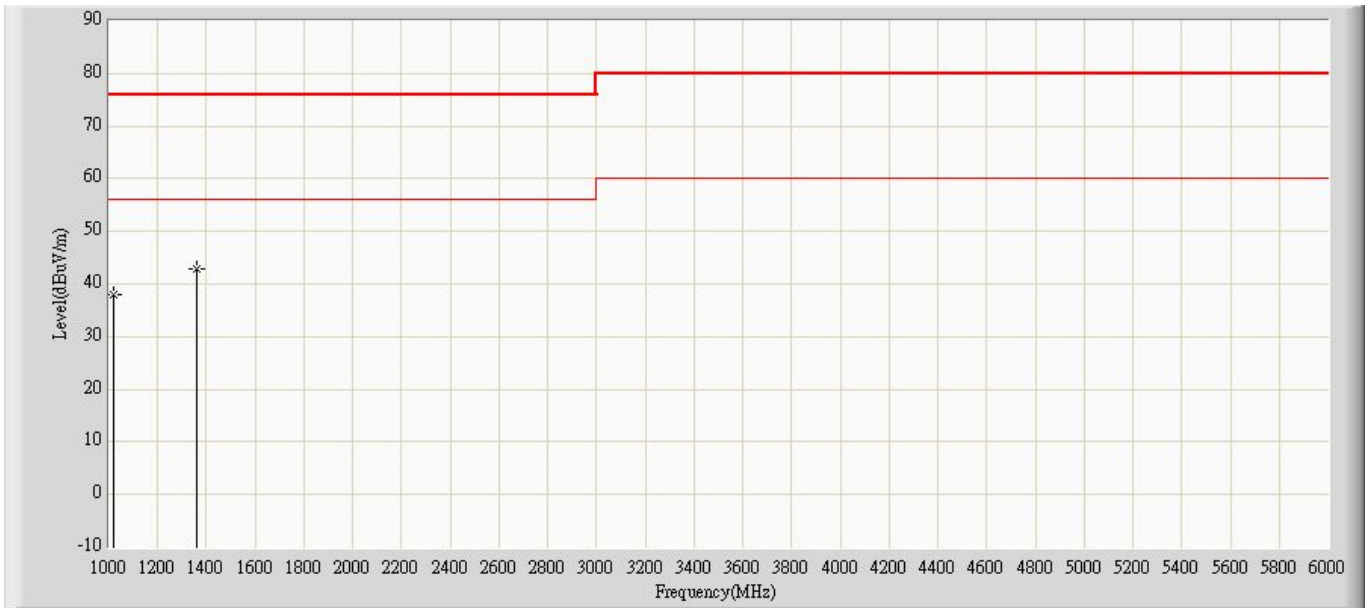

	Frequency (MHz)	Measure Level (dBuV/m)	Reading Level (dBuV)	Over Limit (dB)	Limit (dBuV/m)	Factor	Type
1	1021.000	37.982	46.210	-38.018	76.000	-8.228	PK
2	* 1361.000	42.846	50.020	-33.154	76.000	-7.174	PK

**Note:**

1. All Readings below 1GHz are Quasi-Peak, above are performed with peak and/or average measurements as necessary.
2. " \* ", means this data is the worst emission level.
3. Measurement Level = Reading Level + Factor(Probe+Cable-Amp).

Site: 9x6x6_Chamber	Time: 2011/04/09 - 11:50
Limit: EN55022_A_(Above_1G)	Margin: 0
Probe: 9120D_1-18G_Horn	Polarity: Vertical
EUT: Outdoor Bullet Network Camera	Power: AC 230V/50Hz
Note: Mode 3	

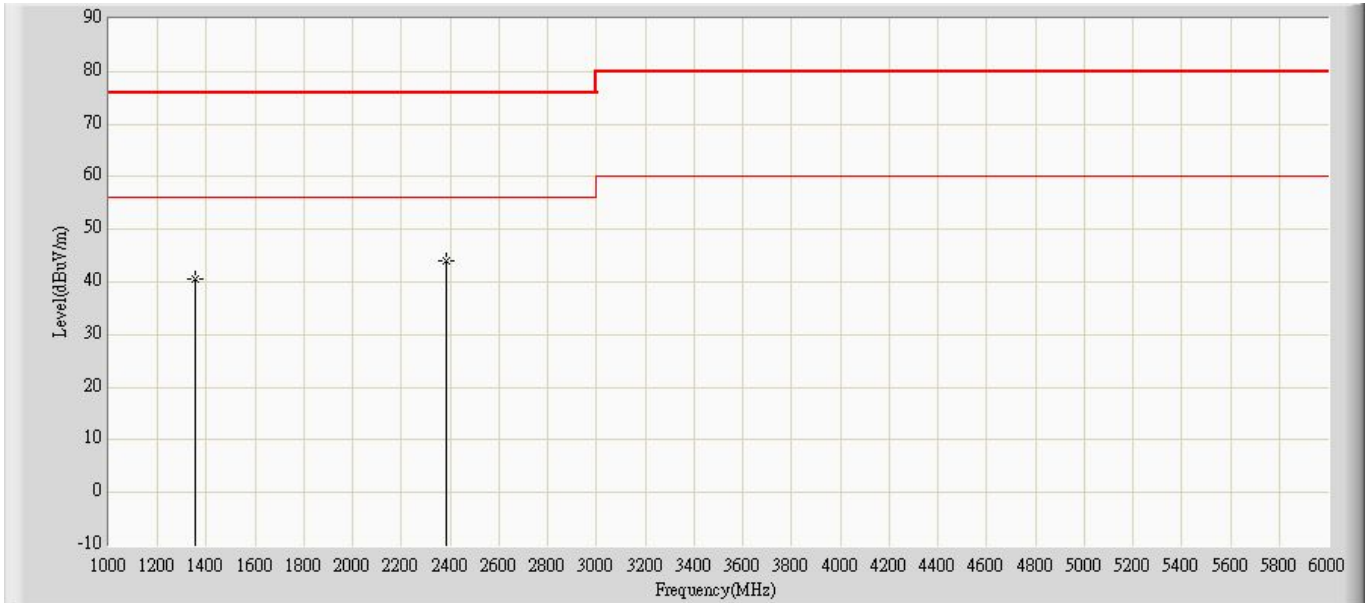

		Frequency (MHz)	Measure Level (dBuV/m)	Reading Level (dBuV)	Over Limit (dB)	Limit (dBuV/m)	Factor	Type
1		1351.000	40.574	47.850	-35.426	76.000	-7.277	PK
2	*	2381.000	44.162	48.940	-31.838	76.000	-4.777	PK

**Note:**

1. All Readings below 1GHz are Quasi-Peak, above are performed with peak and/or average measurements as necessary.
2. " \* ", means this data is the worst emission level.
3. Measurement Level = Reading Level + Factor(Probe+Cable-Amp).

## 5.7. Test Photograph

Test Mode : Mode 1: Normal Operation (DC 12V)

Description : Front View of Radiated Test



Test Mode : Mode 1: Normal Operation (DC 12V)

Description : Back View of Radiated Test



Test Mode : Mode 1: Normal Operation (DC 12V)

Description : Front View of High Frequency Radiated Test



Test Mode : Mode 2: Normal Operation (AC 24V)

Description : Front View of Radiated Test



Test Mode : Mode 2: Normal Operation (AC 24V)

Description : Back View of Radiated Test



Test Mode : Mode 2: Normal Operation (AC 24V)

Description : Front View of High Frequency Radiated Test



Test Mode : Mode 3: Normal Operation (PoE)

Description : Front View of Radiated Test



Test Mode : Mode 3: Normal Operation (PoE)

Description : Back View of Radiated Test



Test Mode : Mode 3: Normal Operation (PoE)

Description : Front View of High Frequency Radiated Test





## 6. Harmonic Current Emission

### 6.1. Test Specification

According to EMC Standard : EN 61000-3-2

### 6.2. Test Setup

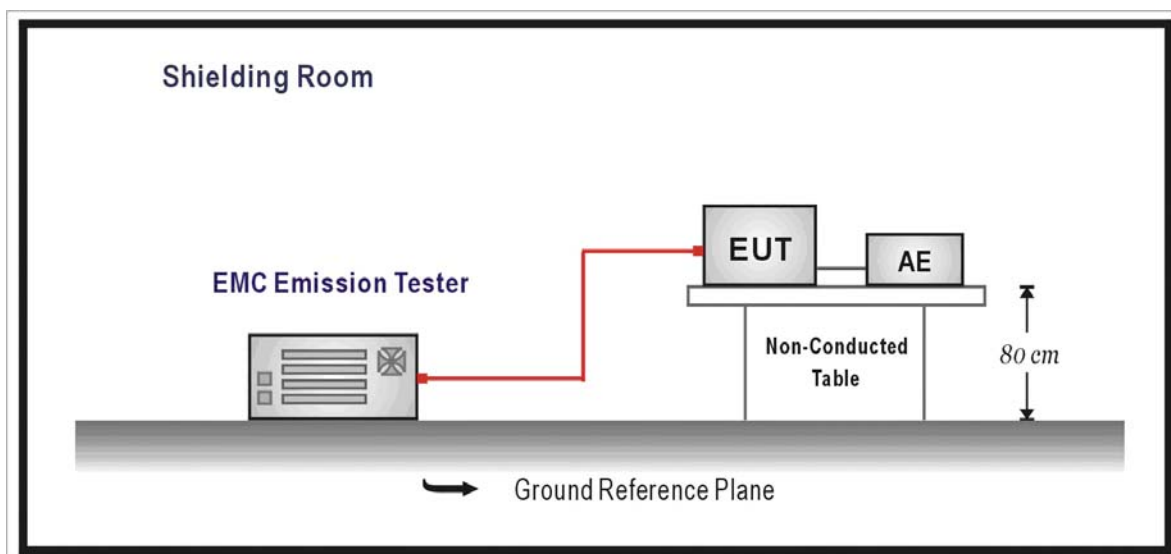

### 6.3. Limit

(a) Limits of Class A Harmonics Currents

Harmonics Order n	Maximum Permissible harmonic current A	Harmonics Order n	Maximum Permissible harmonic current A
Odd harmonics		Even harmonics	
3	2.30	2	1.08
5	1.14	4	0.43
7	0.77	6	0.30
9	0.40	8 ≤ n ≤ 40	0.23 * 8/n
11	0.33		
13	0.21		
15 ≤ n ≤ 39	0.15 * 15/n		

(b) Limits of Class B Harmonics Currents

For Class B equipment, the harmonic of the input current shall not exceed the maximum permissible values given in table that is the limit of Class A multiplied by a factor of 1.5.

(c) Limits of Class C Harmonics Currents

Harmonics Order n	Maximum Permissible harmonic current Expressed as a percentage of the input current at the fundamental frequency %
2	2
3	$30 \cdot \lambda^*$
5	10
7	7
9	5
$11 \leq n \leq 39$ (odd harmonics only)	3

\*  $\lambda$  is the circuit power factor

(d) Limits of Class D Harmonics Currents

Harmonics Order n	Maximum Permissible harmonic current per watt mA/W	Maximum Permissible harmonic current A
3	3.4	2.30
5	1.9	1.14
7	1.0	0.77
9	0.5	0.40
11	0.35	0.33
$11 \leq n \leq 39$ (odd harmonics only)	$3.85/n$	See limit of Class A

**6.4. Test Procedure**

The EUT is supplied in series with power analyzer from a power source having the same normal voltage and frequency as the rated supply voltage and the equipment under test. And the rated voltage at the supply voltage of EUT of 0.94 times and 1.06 times shall be performed.

**6.5. Deviation from Test Standard**

No deviation.

6.6. Test Result

Product	Outdoor Bullet Network Camera		
Test Item	Power Harmonics		
Test Mode	Mode 1: Normal Operation (DC 12V)		
Date of Test	2011/04/17	Test Site	No.3 Shielded Room

Test Result: Pass                      Source qualification: Normal

Current & voltage waveforms

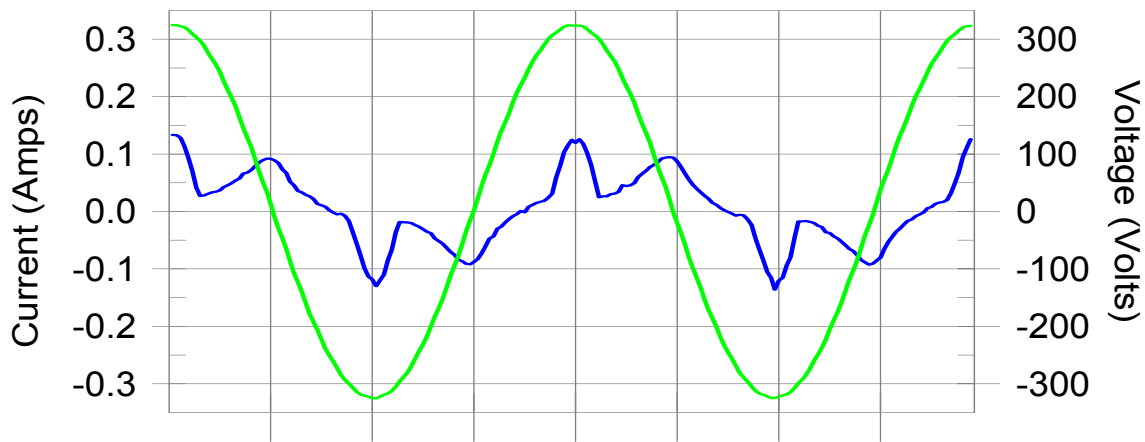

Harmonics and Class A limit line

European Limits

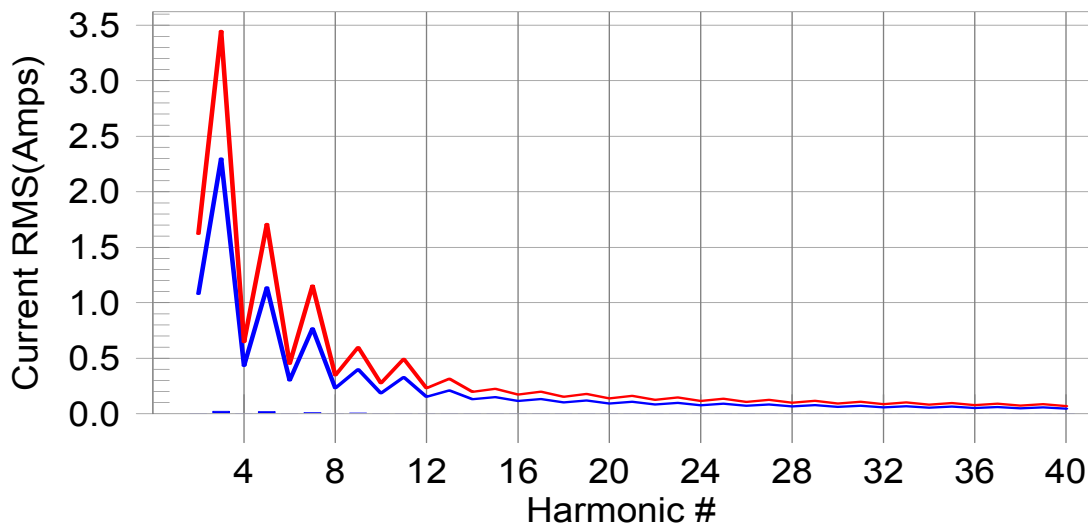

Test result: Pass                      Worst harmonic was #5 with 1.70% of the limit.

Test Result: Pass Source qualification: Normal

THC(A): 0.03 I-THD(%): 59.60 POHC(A): 0.001 POHC Limit(A): 0.251

Highest parameter values during test:

V_RMS (Volts):	229.62	Frequency(Hz):	50.00
I_Peak (Amps):	0.167	I_RMS (Amps):	0.064
I_Fund (Amps):	0.055	Crest Factor:	2.616
Power (Watts):	9.0	Power Factor:	0.615

Harm#	Harms(avg)	100%Limit	%of Limit	Harms(max)	150%Limit	%of Limit	Status
2	0.001	1.080	0.1	0.001	1.620	0.08	Pass
3	0.023	2.300	1.0	0.023	3.450	0.67	Pass
4	0.001	0.430	0.1	0.001	0.645	0.09	Pass
5	0.019	1.140	1.7	0.020	1.710	1.14	Pass
6	0.000	0.300	0.1	0.001	0.450	0.13	Pass
7	0.010	0.770	1.3	0.010	1.155	0.86	Pass
8	0.000	0.230	0.1	0.000	0.345	0.09	Pass
9	0.007	0.400	1.6	0.007	0.600	1.10	Pass
10	0.000	0.184	0.1	0.000	0.276	0.06	Pass
11	0.001	0.330	0.4	0.001	0.495	0.30	Pass
12	0.000	0.153	0.1	0.000	0.230	0.10	Pass
13	0.001	0.210	0.6	0.001	0.315	0.39	Pass
14	0.000	0.131	0.1	0.000	0.197	0.08	Pass
15	0.001	0.150	0.9	0.001	0.225	0.59	Pass
16	0.000	0.115	0.1	0.000	0.173	0.08	Pass
17	0.001	0.132	0.9	0.001	0.199	0.61	Pass
18	0.000	0.102	0.1	0.000	0.153	0.10	Pass
19	0.001	0.118	0.4	0.001	0.178	0.31	Pass
20	0.000	0.092	0.1	0.000	0.138	0.10	Pass
21	0.000	0.107	0.4	0.001	0.161	0.31	Pass
22	0.000	0.084	0.1	0.000	0.125	0.11	Pass
23	0.001	0.098	0.6	0.001	0.147	0.43	Pass
24	0.000	0.077	0.1	0.000	0.115	0.11	Pass
25	0.000	0.090	0.5	0.000	0.135	0.33	Pass
26	0.000	0.071	0.1	0.000	0.106	0.12	Pass
27	0.000	0.083	0.3	0.000	0.125	0.23	Pass
28	0.000	0.066	0.1	0.000	0.099	0.13	Pass
29	0.000	0.078	0.4	0.000	0.116	0.30	Pass
30	0.000	0.061	0.1	0.000	0.092	0.14	Pass
31	0.000	0.073	0.4	0.000	0.109	0.30	Pass
32	0.000	0.058	0.1	0.000	0.086	0.13	Pass
33	0.000	0.068	0.4	0.000	0.102	0.27	Pass
34	0.000	0.054	0.1	0.000	0.081	0.14	Pass
35	0.000	0.064	0.3	0.000	0.096	0.22	Pass
36	0.000	0.051	0.1	0.000	0.077	0.15	Pass
37	0.000	0.061	0.3	0.000	0.091	0.23	Pass
38	0.000	0.048	0.1	0.000	0.073	0.17	Pass
39	0.000	0.058	0.4	0.000	0.087	0.28	Pass
40	0.000	0.046	0.2	0.000	0.069	0.17	Pass

1.Dynamic limits were applied for this test. The highest harmonics values in the above table may not occur at the same window as the maximum harmonics/limit ratio.

2:According to EN61000-3-2 paragraph 7 the note 1 and 2 are valid for all applications having an active input power >75W. Others the result should be pass.

Product	Outdoor Bullet Network Camera		
Test Item	Power Harmonics		
Test Mode	Mode 2: Normal Operation (AC 24V)		
Date of Test	2011/04/17	Test Site	No.3 Shielded Room

Test Result: Pass      Source qualification: Normal

Current & voltage waveforms

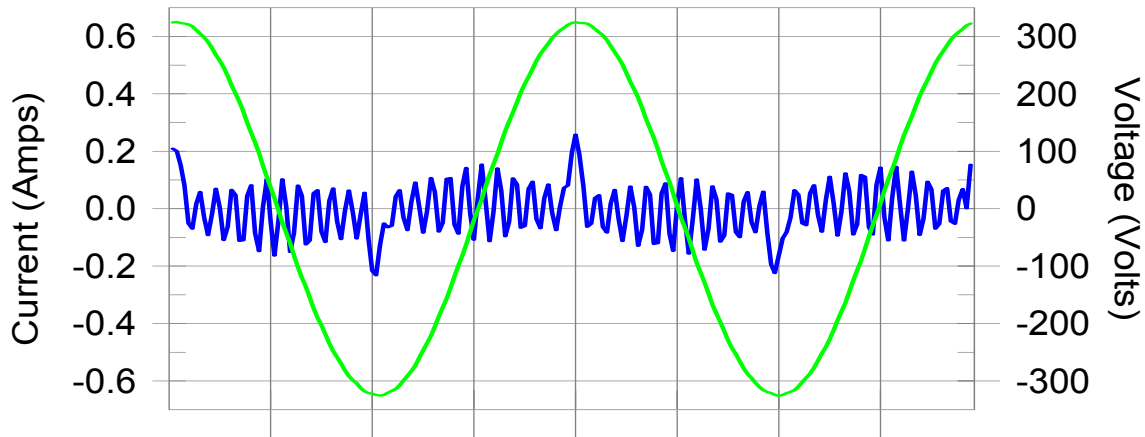

Harmonics and Class A limit line

European Limits

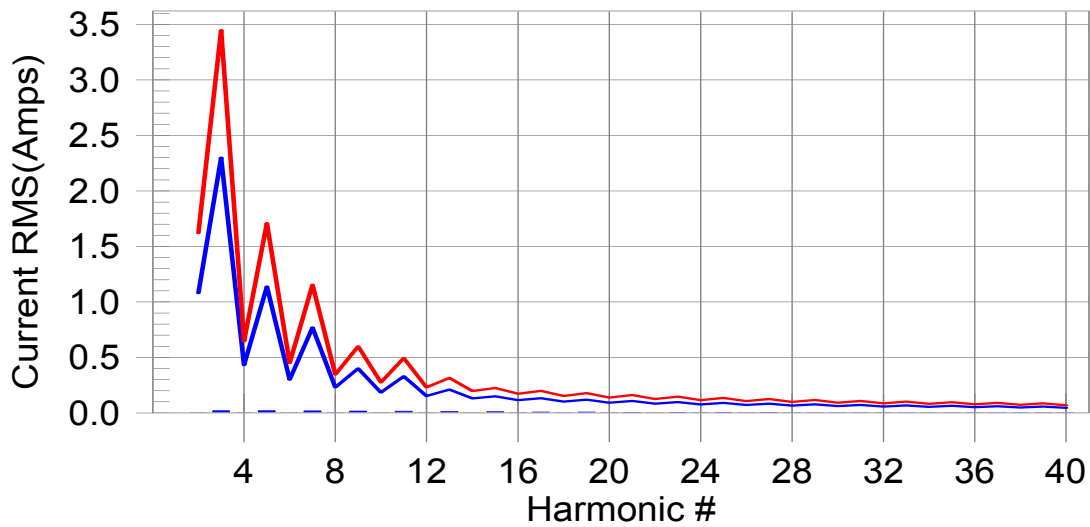

Test result: Pass      Worst harmonic was #15 with 7.40% of the limit.

Test Result: Pass Source qualification: Normal

THC(A): 0.05 I-THD(%): 172.50 POHC(A): 0.008 POHC Limit(A): 0.251

Highest parameter values during test:

V_RMS (Volts):	229.63	Frequency(Hz):	50.00
I_Peak (Amps):	0.317	I_RMS (Amps):	0.091
I_Fund (Amps):	0.027	Crest Factor:	3.520
Power (Watts):	5.0	Power Factor:	0.239

Harm#	Harms(avg)	100%Limit	%of Limit	Harms(max)	150%Limit	%of Limit	Status
2	0.001	1.080	0.1	0.001	1.620	0.05	Pass
3	0.020	2.300	0.9	0.021	3.450	0.60	Pass
4	0.001	0.430	0.2	0.001	0.645	0.12	Pass
5	0.019	1.140	1.7	0.020	1.710	1.16	Pass
6	0.001	0.300	0.2	0.001	0.450	0.21	Pass
7	0.018	0.770	2.4	0.019	1.155	1.60	Pass
8	0.001	0.230	0.3	0.001	0.345	0.23	Pass
9	0.017	0.400	4.2	0.017	0.600	2.82	Pass
10	0.001	0.184	0.4	0.001	0.276	0.28	Pass
11	0.015	0.330	4.5	0.015	0.495	3.07	Pass
12	0.001	0.153	0.4	0.001	0.230	0.36	Pass
13	0.013	0.210	6.2	0.013	0.315	4.21	Pass
14	0.001	0.131	0.5	0.001	0.197	0.37	Pass
15	0.011	0.150	7.4	0.011	0.225	5.01	Pass
16	0.001	0.115	0.5	0.001	0.173	0.40	Pass
17	0.009	0.132	6.9	0.009	0.199	4.68	Pass
18	0.001	0.102	0.6	0.001	0.153	0.44	Pass
19	0.007	0.118	6.2	0.007	0.178	4.21	Pass
20	0.000	0.092	0.5	0.001	0.138	0.42	Pass
21	0.006	0.107	5.3	0.006	0.161	3.59	Pass
22	0.000	0.084	0.5	0.001	0.125	0.45	Pass
23	0.004	0.098	4.3	0.004	0.147	2.96	Pass
24	0.000	0.077	0.5	0.000	0.115	0.41	Pass
25	0.003	0.090	3.4	0.003	0.135	2.32	Pass
26	0.000	0.071	0.5	0.000	0.106	0.40	Pass
27	0.002	0.083	2.6	0.002	0.125	1.80	Pass
28	0.000	0.066	0.4	0.000	0.099	0.36	Pass
29	0.002	0.078	2.0	0.002	0.116	1.42	Pass
30	0.000	0.061	0.5	0.000	0.092	0.42	Pass
31	0.001	0.073	1.7	0.001	0.109	1.18	Pass
32	0.000	0.058	0.4	0.000	0.086	0.31	Pass
33	0.001	0.068	1.5	0.001	0.102	1.07	Pass
34	0.000	0.054	0.3	0.000	0.081	0.32	Pass
35	0.001	0.064	1.5	0.001	0.096	1.05	Pass
36	0.000	0.051	0.3	0.000	0.077	0.29	Pass
37	0.001	0.061	1.4	0.001	0.091	0.97	Pass
38	0.000	0.048	0.3	0.000	0.073	0.30	Pass
39	0.001	0.058	1.2	0.001	0.087	0.84	Pass
40	0.000	0.046	0.3	0.000	0.069	0.32	Pass

1.Dynamic limits were applied for this test. The highest harmonics values in the above table may not occur at the same window as the maximum harmonics/limit ratio.

2:According to EN61000-3-2 paragraph 7 the note 1 and 2 are valid for all applications having an active input power >75W. Others the result should be pass.

## 6.7. Test Photograph

Test Mode : Mode 1: Normal Operation (DC 12V)

Description : Power Harmonics Test Setup



Test Mode : Mode 2: Normal Operation (AC 24V)

Description : Power Harmonics Test Setup





## 7. Voltage Fluctuation and Flicker

### 7.1. Test Specification

According to EMC Standard : EN 61000-3-3

### 7.2. Test Setup

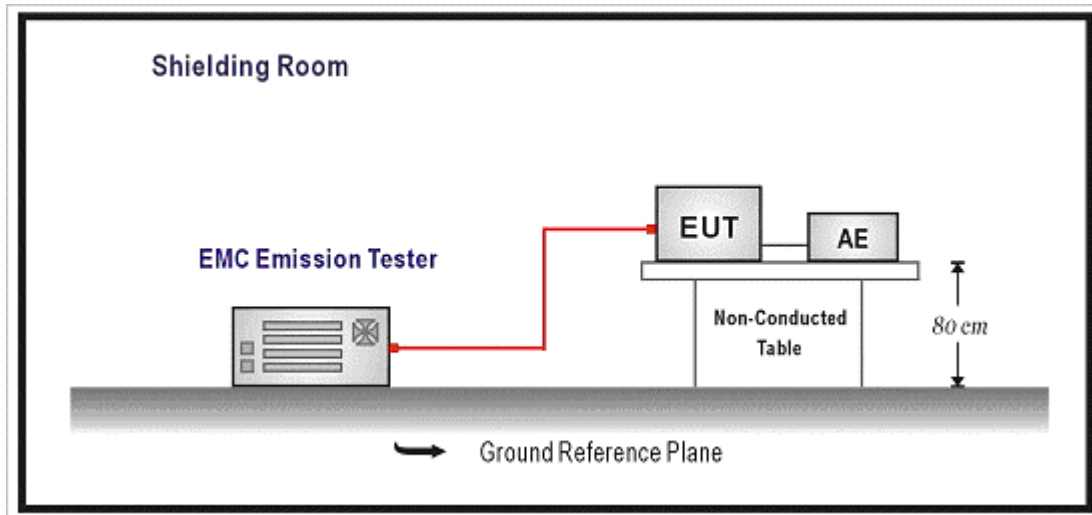

### 7.3. Limit

The following limits apply:

- the value of  $P_{st}$  shall not be greater than 1.0;
- the value of  $P_{1t}$  shall not be greater than 0.65;
- the value of  $d(t)$  during a voltage change shall not exceed 3.3 % for more than 500 ms;
- the relative steady-state voltage change,  $d_c$ , shall not exceed 3.3 %;
- the maximum relative voltage change,  $d_{max}$ , shall not exceed;
  - a) 4 % without additional conditions;
  - b) 6 % for equipment which is:
    - switched manually, or
    - switched automatically more frequently than twice per day, and also has either a delayed restart (the delay being not less than a few tens of seconds), or manual restart, after a power supply interruption.

NOTE The cycling frequency will be further limited by the  $P_{st}$  and  $P_{1t}$  limit.

For example: a  $d_{max}$  of 6% producing a rectangular voltage change characteristic twice per hour will give a  $P_{1t}$  of about 0.65.

- c) 7 % for equipment which is:
- attended whilst in use (for example: hair dryers, vacuum cleaners, kitchen equipment such as mixers, garden equipment such as lawn mowers, portable tools such as electric drills), or
  - switched on automatically, or is intended to be switched on manually, no more than twice per day, and also has either a delayed restart (the delay being not less than a few tens of seconds) or manual restart, after a power supply interruption.

$P_{st}$  and  $P_{1t}$  requirements shall not be applied to voltage changes caused by manual switching.

#### **7.4. Test Procedure**

The EUT is supplied in series with power analyzer from a power source having the same normal voltage and frequency as the rated supply voltage and the equipment under test. And the rated voltage at the supply voltage of EUT of 0.94 times and 1.06 times shall be performed.

#### **7.5. Deviation from Test Standard**

No deviation.

## 7.6. Test Result

Product	Outdoor Bullet Network Camera		
Test Item	Voltage Fluctuation and Flicker		
Test Mode	Mode 1: Normal Operation (DC 12V)		
Date of Test	2011/04/17	Test Site	No.3 Shielded Room

Test Result: Pass

Status: Test Completed

Pst<sub>i</sub> and limit line

European Limits

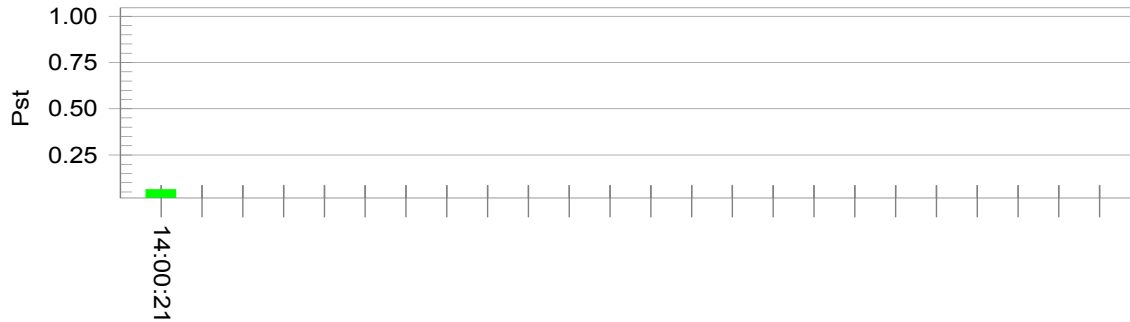

Plt and limit line

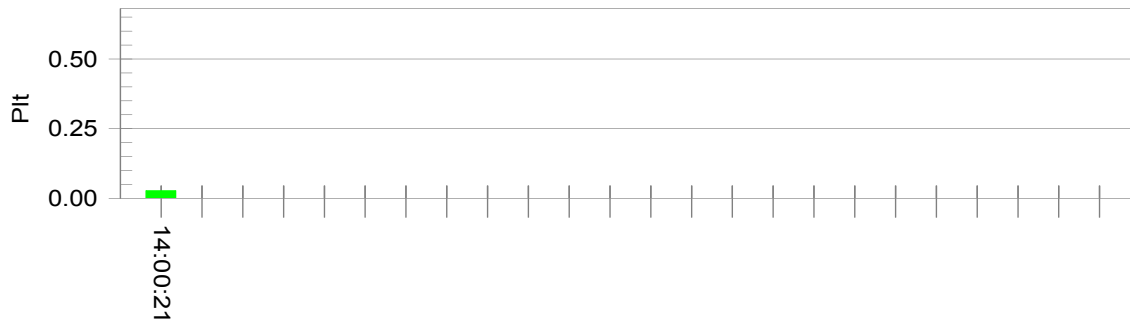

Parameter values recorded during the test:

Vrms at the end of test (Volt):	229.57			
Highest dt (%):	0.00	Test limit (%):	3.30	Pass
Time(mS) > dt:	0.0	Test limit (mS):	500.0	Pass
Highest dc (%):	0.00	Test limit (%):	3.30	Pass
Highest dmax (%):	0.00	Test limit (%):	4.00	Pass
Highest Pst (10 min. period):	0.064	Test limit:	1.000	Pass
Highest Plt (2 hr. period):	0.028	Test limit:	0.650	Pass

Product	Outdoor Bullet Network Camera		
Test Item	Voltage Fluctuation and Flicker		
Test Mode	Mode 2: Normal Operation (AC 24V)		
Date of Test	2011/04/17	Test Site	No.3 Shielded Room

Test Result: Pass

Status: Test Completed

Pstj and limit line

European Limits



Plt and limit line

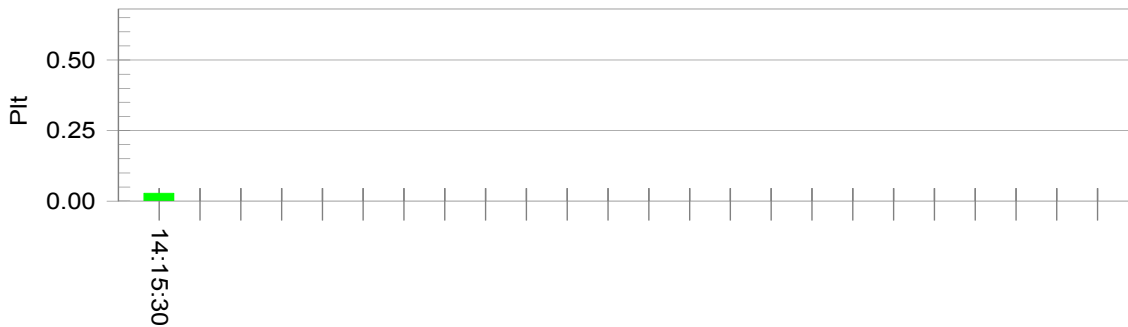

Parameter values recorded during the test:

Vrms at the end of test (Volt):	229.56		
Highest dt (%):	0.00	Test limit (%):	3.30 Pass
Time(mS) > dt:	0.0	Test limit (mS):	500.0 Pass
Highest dc (%):	0.00	Test limit (%):	3.30 Pass
Highest dmax (%):	0.00	Test limit (%):	4.00 Pass
Highest Pst (10 min. period):	0.064	Test limit:	1.000 Pass
Highest Plt (2 hr. period):	0.028	Test limit:	0.650 Pass

## 7.7. Test Photograph

Test Mode : Mode 1: Normal Operation (DC 12V)

Description : Flicker Test Setup



Test Mode : Mode 2: Normal Operation (AC 24V)

Description : Flicker Test Setup

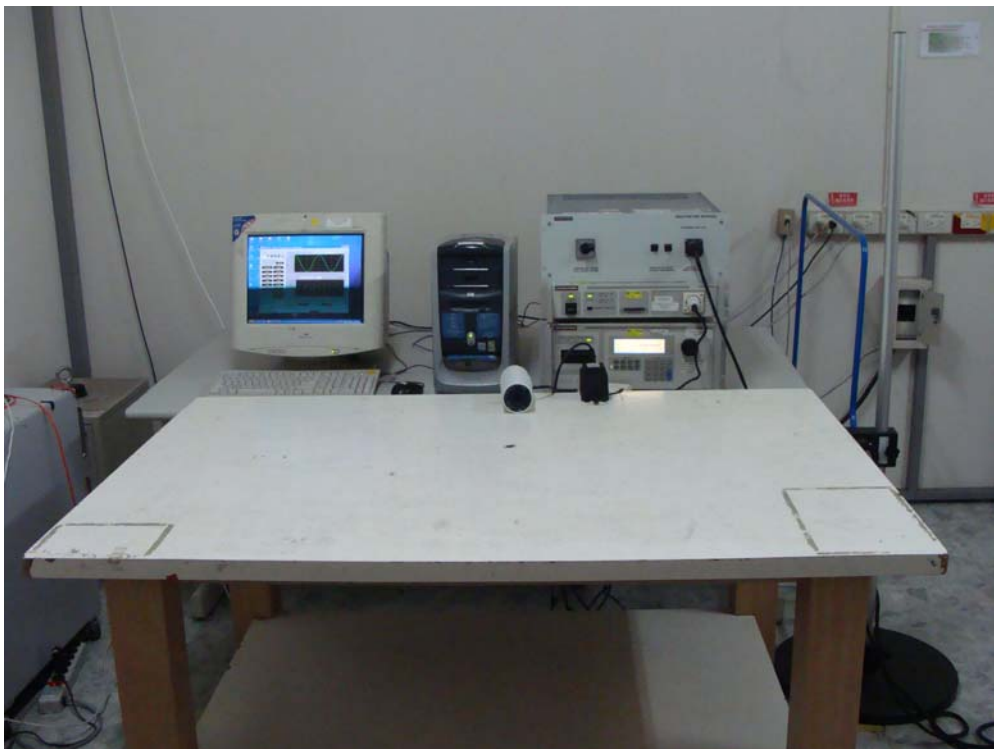

## 8. Electrostatic Discharge

### 8.1. Test Specification

According to Standard : IEC 61000-4-2

### 8.2. Test Setup

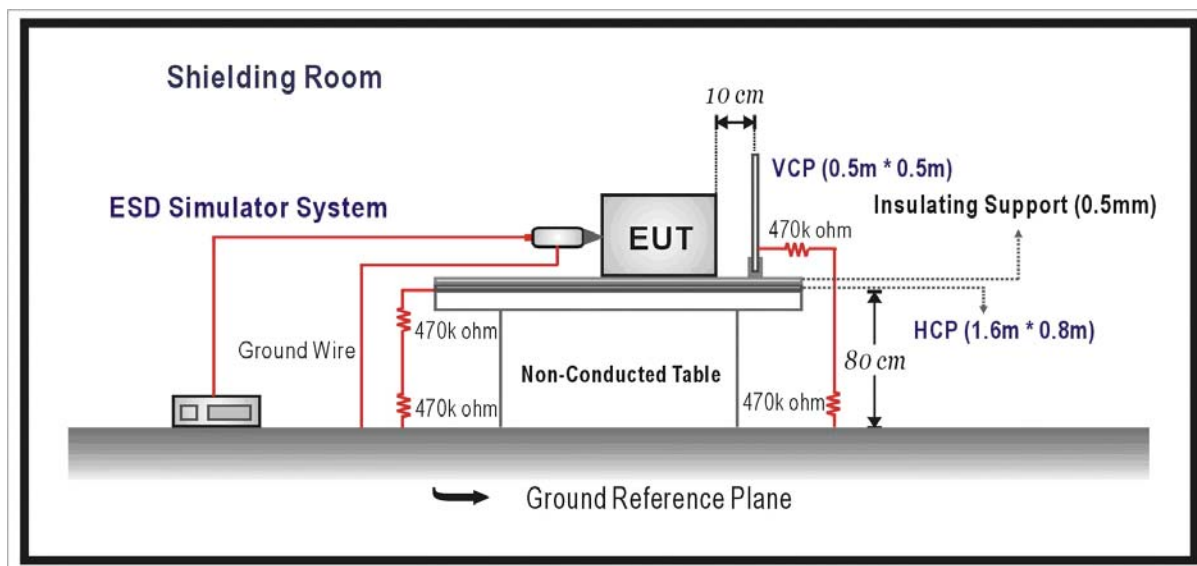

### 8.3. Limit

Item	Environmental Phenomena	Units	Test Specification	Performance Criteria
Enclosure Port				
	Electrostatic Discharge	kV(Charge Voltage)	±8 Air Discharge ±4 Contact Discharge	B

## 8.4. Test Procedure

Direct application of discharges to the EUT:

Contact discharge was applied only to conductive surfaces of the EUT.

Air discharges were applied only to non-conductive surfaces of the EUT.

During the test, it was performed with single discharges. For the single discharge time between successive single discharges will be keep longer 1 second. It was at least ten single discharges with positive and negative at the same selected point.

The selected point, which was performed with electrostatic discharge, was marked on the red label of the EUT.

Indirect application of discharges to the EUT:

Vertical Coupling Plane (VCP):

The coupling plane, of dimensions 0.5m x 0.5m, is placed parallel to, and positioned at a distance 0.1m from, the EUT, with the Discharge Electrode touching the coupling plane.

The four faces of the EUT will be performed with electrostatic discharge. It was at least ten single discharges with positive and negative at the same selected point.

Horizontal Coupling Plane (HCP):

The coupling plane is placed under to the EUT. The generator shall be positioned vertically at a distance of 0.1m from the EUT, with the Discharge Electrode touching the coupling plane.

The four faces of the EUT will be performed with electrostatic discharge. It was at least ten single discharges with positive and negative at the same selected point.

## 8.5. Deviation from Test Standard

No deviation.

**8.6. Test Result**

Product	Outdoor Bullet Network Camera		
Test Item	Electrostatic Discharge		
Test Mode	Mode 1: Normal Operation (DC 12V)		
Date of Test	2011/04/17	Test Site	No.6 Shielded Room

Item	Amount of Discharge	Voltage	Required Criteria	Complied To Criteria (A,B,C)	Results
Air Discharge	10	+8kV	B	A	Pass
	10	-8kV	B	A	Pass
Contact Discharge	25	+4kV	B	A	Pass
	25	-4kV	B	A	Pass
Indirect Discharge (HCP)	25	+4kV	B	A	Pass
	25	-4kV	B	A	Pass
Indirect Discharge (VCP Front)	25	+4kV	B	A	Pass
	25	-4kV	B	A	Pass
Indirect Discharge (VCP Left)	25	+4kV	B	A	Pass
	25	-4kV	B	A	Pass
Indirect Discharge (VCP Back)	25	+4kV	B	A	Pass
	25	-4kV	B	A	Pass
Indirect Discharge (VCP Right)	25	+4kV	B	A	Pass
	25	-4kV	B	A	Pass

Note:

The testing performed is from lowest level up to the highest level as required by standard, but only highest level is shown on the report.

NR: No Requirement

- Meet criteria A: Operate as intended during and after the test
- Meet criteria B: Operate as intended after the test
- Meet criteria C: Loss/Error of function
- Additional Information
  - EUT stopped operation and could / could not be reset by operator at \_\_\_\_ kV.
  - No false alarms or other malfunctions were observed during or after the test.

Remark:

The Contact discharges were applied at least total 200 discharges at a minimum of four test points.



Product	Outdoor Bullet Network Camera		
Test Item	Electrostatic Discharge		
Test Mode	Mode 2: Normal Operation (AC 24V)		
Date of Test	2011/04/17	Test Site	No.6 Shielded Room

Item	Amount of Discharge	Voltage	Required Criteria	Complied To Criteria (A,B,C)	Results
Air Discharge	10	+8kV	B	A	Pass
	10	-8kV	B	A	Pass
Contact Discharge	25	+4kV	B	A	Pass
	25	-4kV	B	A	Pass
Indirect Discharge (HCP)	25	+4kV	B	A	Pass
	25	-4kV	B	A	Pass
Indirect Discharge (VCP Front)	25	+4kV	B	A	Pass
	25	-4kV	B	A	Pass
Indirect Discharge (VCP Left)	25	+4kV	B	A	Pass
	25	-4kV	B	A	Pass
Indirect Discharge (VCP Back)	25	+4kV	B	A	Pass
	25	-4kV	B	A	Pass
Indirect Discharge (VCP Right)	25	+4kV	B	A	Pass
	25	-4kV	B	A	Pass

**Note:**

The testing performed is from lowest level up to the highest level as required by standard, but only highest level is shown on the report.

NR: No Requirement

- Meet criteria A: Operate as intended during and after the test
- Meet criteria B: Operate as intended after the test
- Meet criteria C: Loss/Error of function
- Additional Information
  - EUT stopped operation and could / could not be reset by operator at \_\_\_\_ kV.
  - No false alarms or other malfunctions were observed during or after the test.

**Remark:**

The Contact discharges were applied at least total 200 discharges at a minimum of four test points.

Product	Outdoor Bullet Network Camera		
Test Item	Electrostatic Discharge		
Test Mode	Mode 3: Normal Operation (PoE)		
Date of Test	2011/04/17	Test Site	No.6 Shielded Room

Item	Amount of Discharge	Voltage	Required Criteria	Complied To Criteria (A,B,C)	Results
Air Discharge	10	+8kV	B	A	Pass
	10	-8kV	B	A	Pass
Contact Discharge	25	+4kV	B	A	Pass
	25	-4kV	B	A	Pass
Indirect Discharge (HCP)	25	+4kV	B	A	Pass
	25	-4kV	B	A	Pass
Indirect Discharge (VCP Front)	25	+4kV	B	A	Pass
	25	-4kV	B	A	Pass
Indirect Discharge (VCP Left)	25	+4kV	B	A	Pass
	25	-4kV	B	A	Pass
Indirect Discharge (VCP Back)	25	+4kV	B	A	Pass
	25	-4kV	B	A	Pass
Indirect Discharge (VCP Right)	25	+4kV	B	A	Pass
	25	-4kV	B	A	Pass

**Note:**

The testing performed is from lowest level up to the highest level as required by standard, but only highest level is shown on the report.

NR: No Requirement

- Meet criteria A: Operate as intended during and after the test
- Meet criteria B: Operate as intended after the test
- Meet criteria C: Loss/Error of function
- Additional Information
  - EUT stopped operation and could / could not be reset by operator at \_\_\_\_ kV.
  - No false alarms or other malfunctions were observed during or after the test.

**Remark:**

The Contact discharges were applied at least total 200 discharges at a minimum of four test points.

## 8.7. Test Photograph

Test Mode : Mode 1: Normal Operation (DC 12V)

Description : ESD Test Setup



Test Mode : Mode 2: Normal Operation (AC 24V)

Description : ESD Test Setup

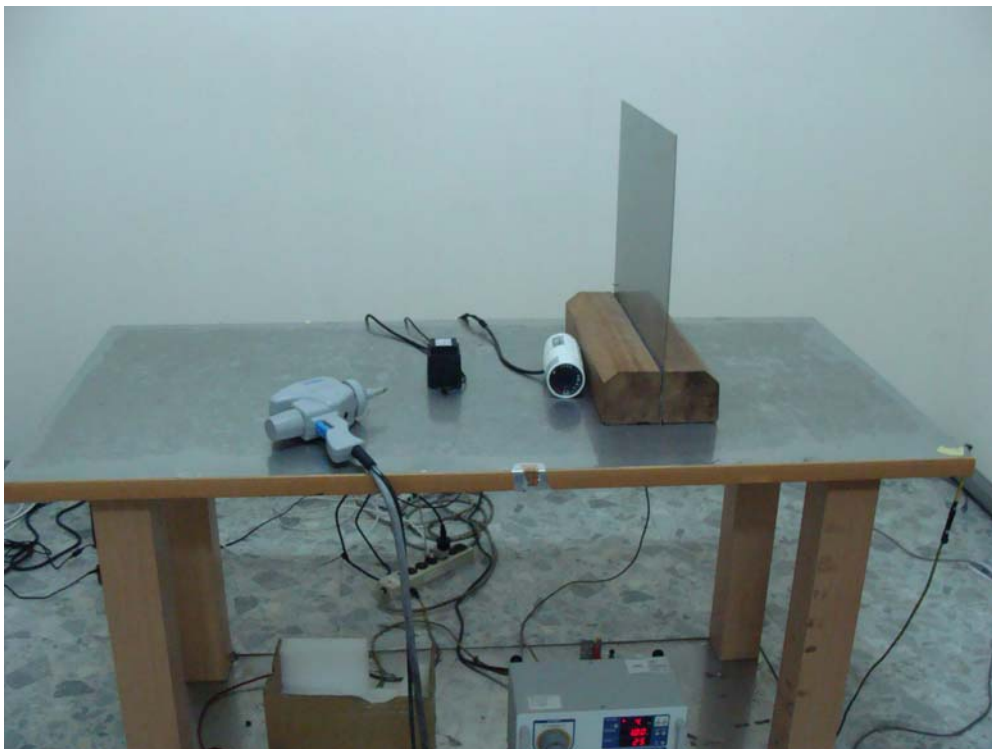

Test Mode : Mode 3: Normal Operation (PoE)

Description : ESD Test Setup



## 9. Radiated Susceptibility

### 9.1. Test Specification

According to Standard : IEC 61000-4-3

### 9.2. Test Setup

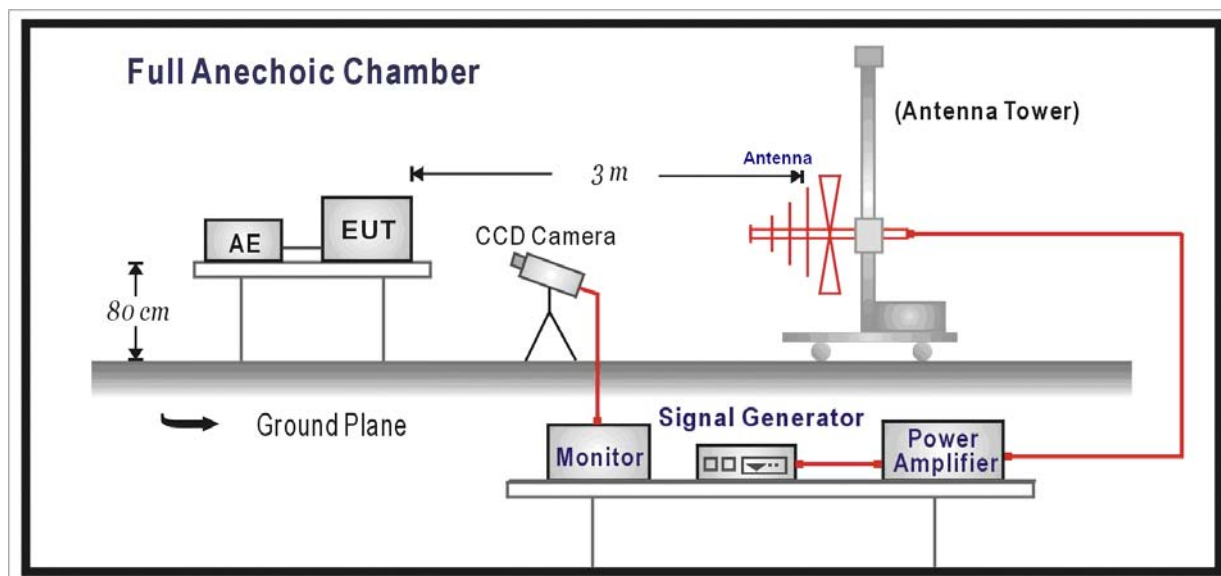

### 9.3. Limit

Item	Environmental Phenomena	Units	Test Specification	Performance Criteria
Enclosure Port				
	Radio-Frequency	MHz	80-1000	A
	Electromagnetic Field	V/m(Un-modulated, rms)	3	
	Amplitude Modulated	% AM (1kHz)	80	

**9.4. Test Procedure**

The EUT and load, which are placed on a table that is 0.8 meter above ground, are placed with one coincident with the calibration plane such that the distance from antenna to the EUT was 3 meters.

Both horizontal and vertical polarization of the antenna and four sides of the EUT are set on measurement.

In order to judge the EUT performance, a CCD camera is used to monitor EUT screen.

All the scanning conditions are as follows:

Condition of Test	Remarks
1. Field Strength	3 V/m Level 2
2. Radiated Signal	AM 80% Modulated with 1kHz
3. Scanning Frequency	80MHz - 1000MHz
4. Dwell Time	3 Seconds
5. Frequency step size $\Delta f$ :	1%
6. The rate of Swept of Frequency	$1.5 \times 10^{-3}$ decades/s

**9.5. Deviation from Test Standard**

No deviation.

**9.6. Test Result**

Product	Outdoor Bullet Network Camera		
Test Item	Radiated susceptibility		
Test Mode	Mode 1: Normal Operation (DC 12V)		
Date of Test	2011/04/17	Test Site	Chamber5

Frequency (MHz)	Position (Angle)	Polarity (H or V)	Field Strength (V/m)	Required Criteria	Complied To Criteria (A, B, C)	Results
80-1000	FRONT	H	3	A	A	PASS
80-1000	FRONT	V	3	A	A	PASS
80-1000	BACK	H	3	A	A	PASS
80-1000	BACK	V	3	A	A	PASS
80-1000	RIGHT	H	3	A	A	PASS
80-1000	RIGHT	V	3	A	A	PASS
80-1000	LEFT	H	3	A	A	PASS
80-1000	LEFT	V	3	A	A	PASS
80-1000	UP	H	3	A	A	PASS
80-1000	UP	V	3	A	A	PASS
80-1000	DOWN	H	3	A	A	PASS
80-1000	DOWN	V	3	A	A	PASS

**Note:**

The testing performed is from lowest level up to the highest level as required by standard, but only highest level is shown on the report.

- Meet criteria A: Operate as intended during and after the test
- Meet criteria B: Operate as intended after the test
- Meet criteria C: Loss/Error of function
- Additional Information
  - There was no observable degradation in performance.
  - EUT stopped operation and could / could not be reset by operator at \_\_\_\_\_ V/m at frequency \_\_\_\_\_ MHz.
- No false alarms or other malfunctions were observed during or after the test.

Product	Outdoor Bullet Network Camera		
Test Item	Radiated susceptibility		
Test Mode	Mode 2: Normal Operation (AC 24V)		
Date of Test	2011/04/17	Test Site	Chamber5

Frequency (MHz)	Position (Angle)	Polarity (H or V)	Field Strength (V/m)	Required Criteria	Complied To Criteria (A, B, C)	Results
80-1000	FRONT	H	3	A	A	PASS
80-1000	FRONT	V	3	A	A	PASS
80-1000	BACK	H	3	A	A	PASS
80-1000	BACK	V	3	A	A	PASS
80-1000	RIGHT	H	3	A	A	PASS
80-1000	RIGHT	V	3	A	A	PASS
80-1000	LEFT	H	3	A	A	PASS
80-1000	LEFT	V	3	A	A	PASS
80-1000	UP	H	3	A	A	PASS
80-1000	UP	V	3	A	A	PASS
80-1000	DOWN	H	3	A	A	PASS
80-1000	DOWN	V	3	A	A	PASS

**Note:**

The testing performed is from lowest level up to the highest level as required by standard, but only highest level is shown on the report.

- Meet criteria A: Operate as intended during and after the test
- Meet criteria B: Operate as intended after the test
- Meet criteria C: Loss/Error of function
- Additional Information
  - There was no observable degradation in performance.
  - EUT stopped operation and could / could not be reset by operator at \_\_\_\_\_ V/m at frequency \_\_\_\_\_ MHz.
- No false alarms or other malfunctions were observed during or after the test.



Product	Outdoor Bullet Network Camera		
Test Item	Radiated susceptibility		
Test Mode	Mode 3: Normal Operation (PoE)		
Date of Test	2011/04/17	Test Site	Chamber5

Frequency (MHz)	Position (Angle)	Polarity (H or V)	Field Strength (V/m)	Required Criteria	Complied To Criteria (A, B, C)	Results
80-1000	FRONT	H	3	A	A	PASS
80-1000	FRONT	V	3	A	A	PASS
80-1000	BACK	H	3	A	A	PASS
80-1000	BACK	V	3	A	A	PASS
80-1000	RIGHT	H	3	A	A	PASS
80-1000	RIGHT	V	3	A	A	PASS
80-1000	LEFT	H	3	A	A	PASS
80-1000	LEFT	V	3	A	A	PASS
80-1000	UP	H	3	A	A	PASS
80-1000	UP	V	3	A	A	PASS
80-1000	DOWN	H	3	A	A	PASS
80-1000	DOWN	V	3	A	A	PASS

**Note:**

The testing performed is from lowest level up to the highest level as required by standard, but only highest level is shown on the report.

- Meet criteria A: Operate as intended during and after the test
- Meet criteria B: Operate as intended after the test
- Meet criteria C: Loss/Error of function
- Additional Information
  - There was no observable degradation in performance.
  - EUT stopped operation and could / could not be reset by operator at \_\_\_\_\_ V/m at frequency \_\_\_\_\_ MHz.
- No false alarms or other malfunctions were observed during or after the test.

## 9.7. Test Photograph

Test Mode : Mode 1: Normal Operation (DC 12V)

Description : Radiated Susceptibility Test Setup

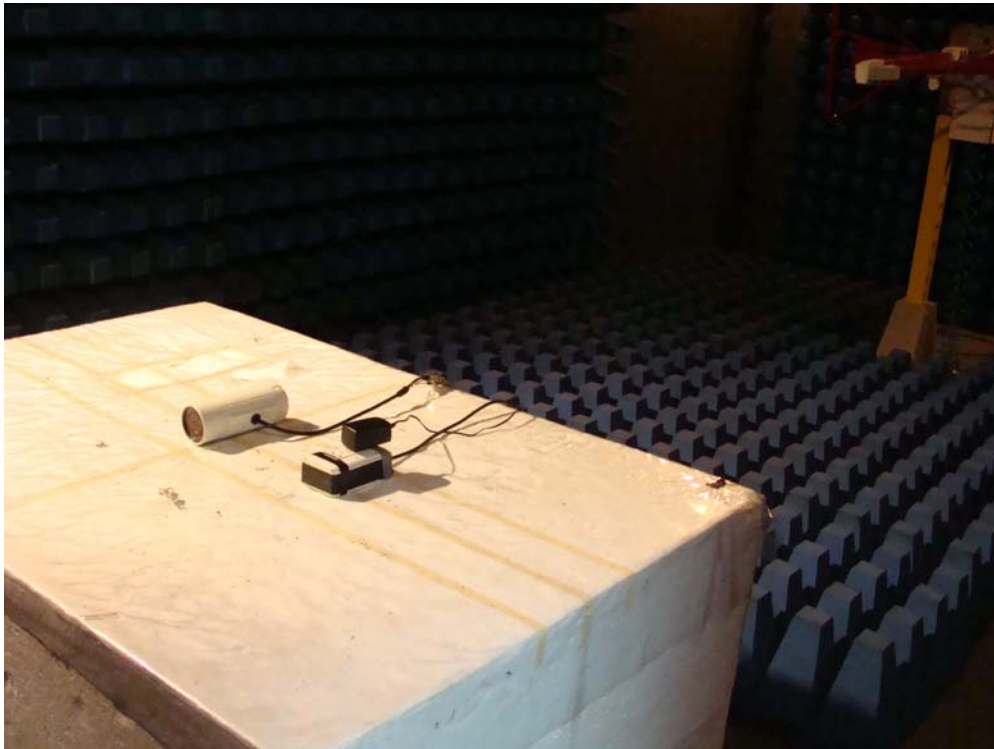

Test Mode : Mode 2: Normal Operation (AC 24V)

Description : Radiated Susceptibility Test Setup

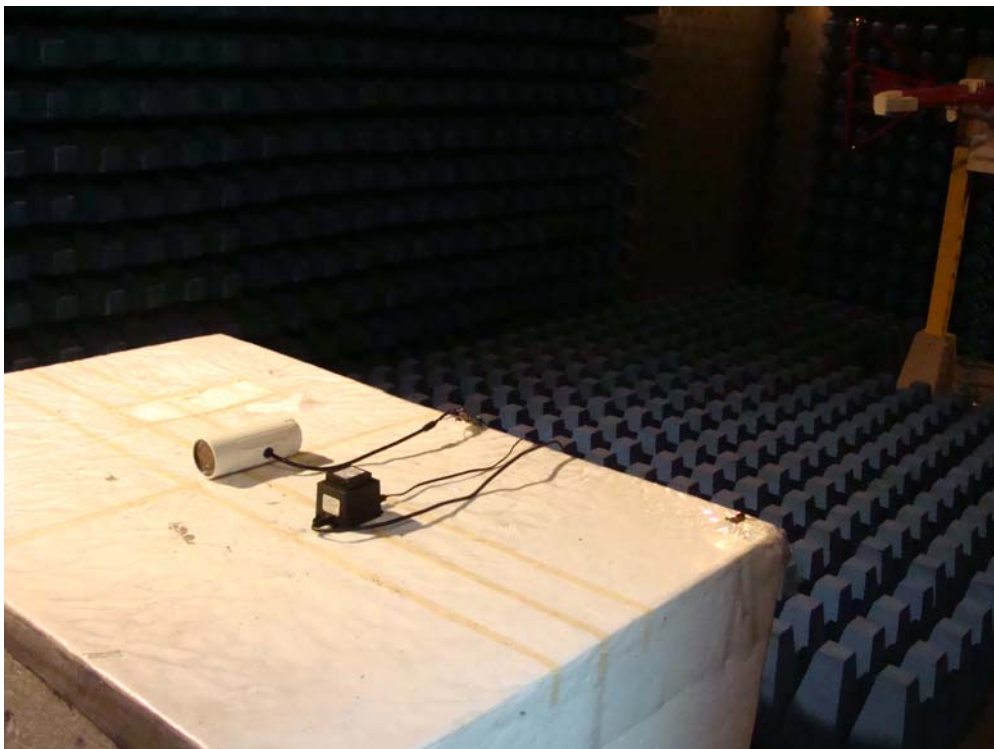

Test Mode : Mode 3: Normal Operation (PoE)

Description : Radiated Susceptibility Test Setup

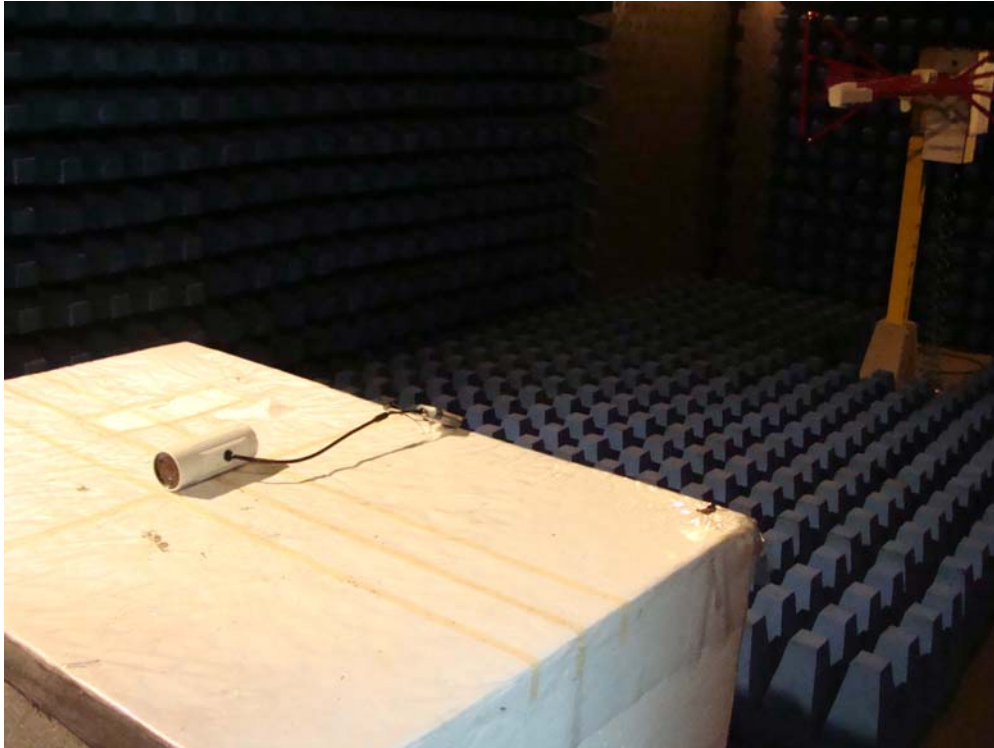

10. Electrical Fast Transient/Burst

10.1. Test Specification

According to Standard : IEC 61000-4-4

10.2. Test Setup

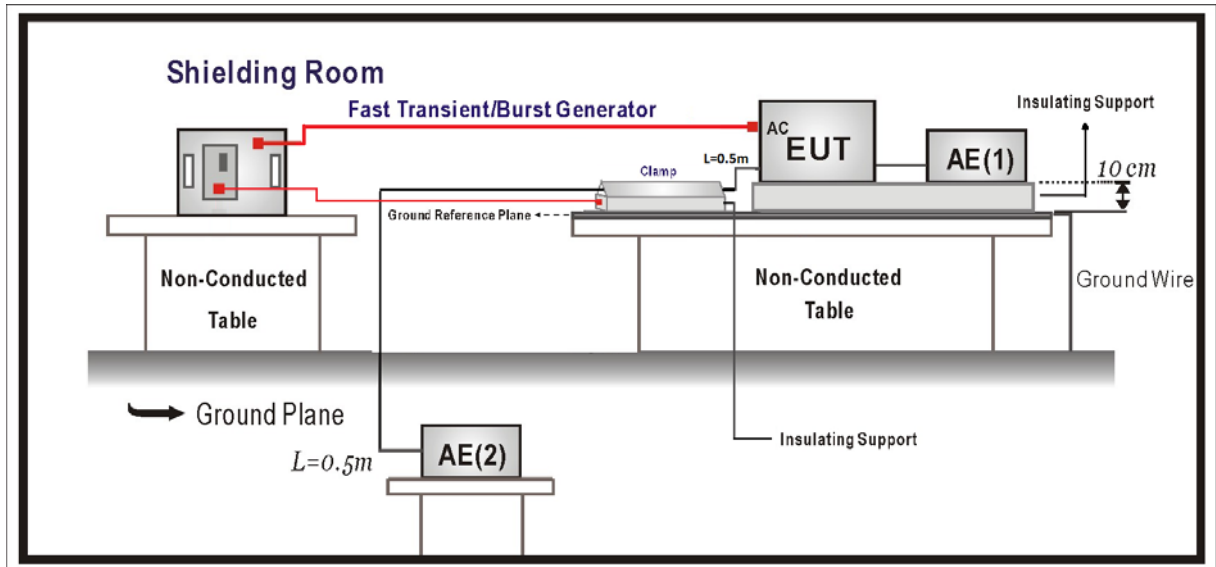

10.3. Limit

Item	Environmental Phenomena	Units	Test Specification	Performance Criteria
I/O and communication ports				
	Fast Transients Common Mode	kV (Peak) Tr/Th ns Rep. Frequency kHz	+0.5 5/50 5	B
Input DC Power Ports				
	Fast Transients Common Mode	kV (Peak) Tr/Th ns Rep. Frequency kHz	+0.5 5/50 5	B
Input AC Power Ports				
	Fast Transients Common Mode	kV (Peak) Tr/Th ns Rep. Frequency kHz	+1 5/50 5	B

#### 10.4. Test Procedure

The EUT is placed on a table that is 0.8 meter height. A ground reference plane is placed on the table, and uses a 0.1m insulation between the EUT and ground reference plane.

The minimum area of the ground reference plane is 1m\*1m, and 0.65mm thick min, and projected beyond the EUT by at least 0.1m on all sides.

Test on I/O and communication ports:

The EFT interference signal is through a coupling clamp device couples to the signal and control lines of the EUT with burst noise for 1 minute.

Test on power supply ports:

The EUT is connected to the power mains through a coupling device that directly couples the EFT/B interference signal.

Each of the Line and Neutral conductors is impressed with burst noise for 1 minute.

The length of the signal and power lines between the coupling device and the EUT is 0.5m.

#### 10.5. Deviation from Test Standard

No deviation.

**10.6. Test Result**

Product	Outdoor Bullet Network Camera		
Test Item	Electrical fast transient/burst		
Test Mode	Mode 1: Normal Operation (DC 12V)		
Date of Test	2011/04/17	Test Site	No.3 Shielded Room

Inject Line	Polarity	Voltage kV	Inject Time (Second)	Inject Method	Required Criteria	Complied to Criteria	Result
L-N	±	1kV	60	Direct	B	A	PASS
LAN	±	0.5kV	60	Clamp	B	A	PASS

Note:

The testing performed is from lowest level up to the highest level as required by standard, but only highest level is shown on the report.

- Meet criteria A : Operate as intended during and after the test
- Meet criteria B : Operate as intended after the test
- Meet criteria C : Loss/Error of function
- Additional Information
  - EUT stopped operation and could / could not be reset by operator at \_\_\_\_\_ kV of Line \_\_\_\_\_.
- No false alarms or other malfunctions were observed during or after the test.

Product	Outdoor Bullet Network Camera		
Test Item	Electrical fast transient/burst		
Test Mode	Mode 2: Normal Operation (AC 24V)		
Date of Test	2011/04/17	Test Site	No.3 Shielded Room

Inject Line	Polarity	Voltage kV	Inject Time (Second)	Inject Method	Required Criteria	Complied to Criteria	Result
L-N	±	1kV	60	Direct	B	A	PASS
LAN	±	0.5kV	60	Clamp	B	A	PASS

**Note:**

The testing performed is from lowest level up to the highest level as required by standard, but only highest level is shown on the report.

- Meet criteria A : Operate as intended during and after the test
- Meet criteria B : Operate as intended after the test
- Meet criteria C : Loss/Error of function
- Additional Information
  - EUT stopped operation and could / could not be reset by operator at \_\_\_\_\_ kV of Line \_\_\_\_\_.
- No false alarms or other malfunctions were observed during or after the test.

Product	Outdoor Bullet Network Camera		
Test Item	Electrical fast transient/burst		
Test Mode	Mode 3: Normal Operation (PoE)		
Date of Test	2011/04/17	Test Site	No.3 Shielded Room

Inject Line	Polarity	Voltage kV	Inject Time (Second)	Inject Method	Required Criteria	Complied to Criteria	Result
LAN	±	0.5kV	60	Clamp	B	A	PASS

**Note:**

The testing performed is from lowest level up to the highest level as required by standard, but only highest level is shown on the report.

- Meet criteria A : Operate as intended during and after the test
- Meet criteria B : Operate as intended after the test
- Meet criteria C : Loss/Error of function
- Additional Information
  - EUT stopped operation and could / could not be reset by operator at \_\_\_\_\_ kV of Line \_\_\_\_\_.
- No false alarms or other malfunctions were observed during or after the test.



## 10.7. Test Photograph

Test Mode : Mode 1: Normal Operation (DC 12V)

Description : EFT/B Test Setup



Test Mode : Mode 1: Normal Operation (DC 12V)

Description : EFT/B Test Setup-Clamp



Test Mode : Mode 2: Normal Operation (AC 24V)

Description : EFT/B Test Setup



Test Mode : Mode 2: Normal Operation (AC 24V)

Description : EFT/B Test Setup-Clamp



Test Mode : Mode 3: Normal Operation (PoE)

Description : EFT/B Test Setup



11. Surge

11.1. Test Specification

According to Standard : IEC 61000-4-5

11.2. Test Setup

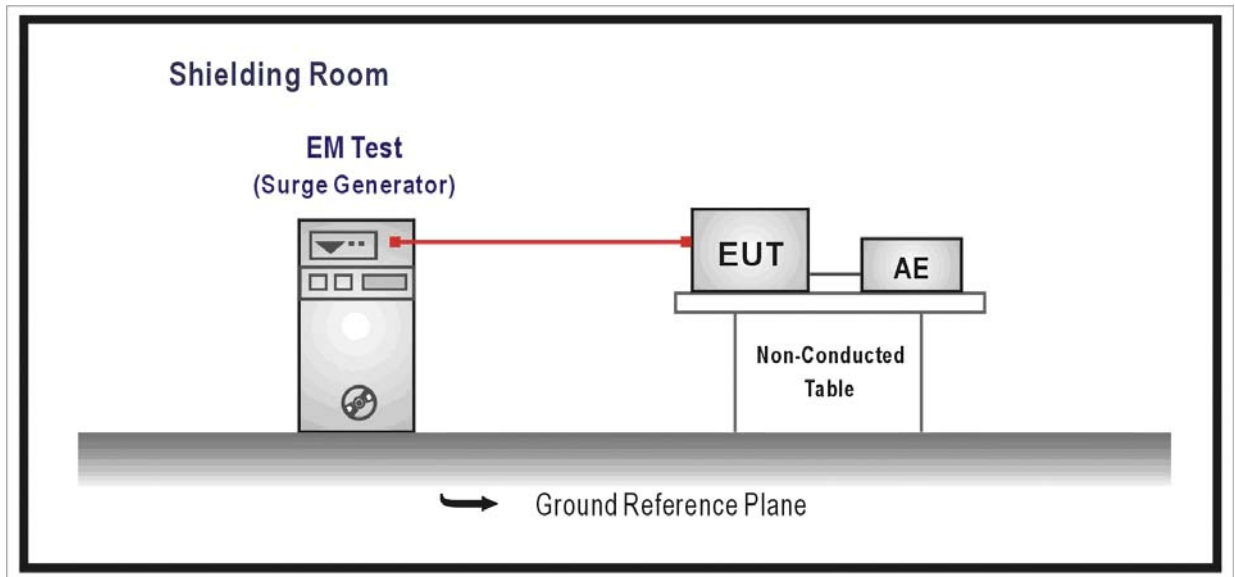

11.3. Limit

Item	Environmental Phenomena	Units	Test Specification	Performance Criteria
Signal Ports and Telecommunication Ports(See 1) and 2) )				
	Surges Line to Ground	Tr/Th us kV	1.2/50 (8/20) ± 1	B
Input DC Power Ports				
	Surges Line to Ground	Tr/Th us kV	1.2/50 (8/20) ± 0.5	B
AC Input and AC Output Power Ports				
	Surges Line to Line Line to Ground	Tr/Th us kV kV	1.2/50 (8/20) ± 1 ± 2	B

Notes:

- 1) Applicable only to ports which according to the manufacturer’s may directly to outdoor cables.
- 2) Where normal functioning cannot be achieved because of the impact of the CDN on the EUT, no immunity test shall be required.

#### **11.4. Test Procedure**

The EUT and its load are placed on a table that is 0.8 meter above a metal ground plane measured 1m\*1m min. and 0.65mm thick min. And projected beyond the EUT by at least 0.1m on all sides. The length of power cord between the coupling device and the EUT shall be 2m or less.

For Input and Output AC Power or DC Input and DC Output Power Ports:

The EUT is connected to the power mains through a coupling device that directly couples the Surge interference signal.

The surge noise shall be applied synchronized to the voltage phase at 0<sup>0</sup>, 90<sup>0</sup>, 180<sup>0</sup>, 270<sup>0</sup> and the peak value of the a.c. voltage wave. (Positive and negative)

Each of Line-Earth and Line-Line is impressed with a sequence of five surge voltages with interval of 1 min.

#### **11.5. Deviation from Test Standard**

No deviation.

## 11.6. Test Result

Product	Outdoor Bullet Network Camera		
Test Item	Surge		
Test Mode	Mode 1: Normal Operation (DC 12V)		
Date of Test	2011/04/17	Test Site	No.3 Shielded Room

Inject Line	Polarity	Angle	Voltage kV	Time Interval (Second)	Inject Method	Required Criteria	Complied to Criteria	Result
L-N	±	0	1kV	60	Direct	B	A	PASS
L-N	±	90	1kV	60	Direct	B	A	PASS
L-N	±	180	1kV	60	Direct	B	A	PASS
L-N	±	270	1kV	60	Direct	B	A	PASS

**Note:**

The testing performed is from lowest level up to the highest level as required by standard, but only highest level is shown on the report.

- Meet criteria A : Operate as intended during and after the test
- Meet criteria B : Operate as intended after the test
- Meet criteria C : Loss/Error of function
- Additional Information
  - EUT stopped operation and could / could not be reset by operator at \_\_\_\_\_ kV of Line \_\_\_\_\_.
- No false alarms or other malfunctions were observed during or after the test.

Product	Outdoor Bullet Network Camera		
Test Item	Surge		
Test Mode	Mode 2: Normal Operation (AC 24V)		
Date of Test	2011/04/17	Test Site	No.3 Shielded Room

Inject Line	Polarity	Angle	Voltage kV	Time Interval (Second)	Inject Method	Required Criteria	Complied to Criteria	Result
L-N	±	0	1kV	60	Direct	B	A	PASS
L-N	±	90	1kV	60	Direct	B	A	PASS
L-N	±	180	1kV	60	Direct	B	A	PASS
L-N	±	270	1kV	60	Direct	B	A	PASS

**Note:**

The testing performed is from lowest level up to the highest level as required by standard, but only highest level is shown on the report.

- Meet criteria A : Operate as intended during and after the test
- Meet criteria B : Operate as intended after the test
- Meet criteria C : Loss/Error of function
- Additional Information
  - EUT stopped operation and could / could not be reset by operator at \_\_\_\_\_ kV of Line \_\_\_\_\_.
- No false alarms or other malfunctions were observed during or after the test.

## 11.7. Test Photograph

Test Mode : Mode 1: Normal Operation (DC 12V)

Description : SURGE Test Setup



Test Mode : Mode 2: Normal Operation (AC 24V)

Description : SURGE Test Setup





## 12. Conducted Susceptibility

### 12.1. Test Specification

According to Standard : IEC 61000-4-6

### 12.2. Test Setup

#### CDN Test Mode

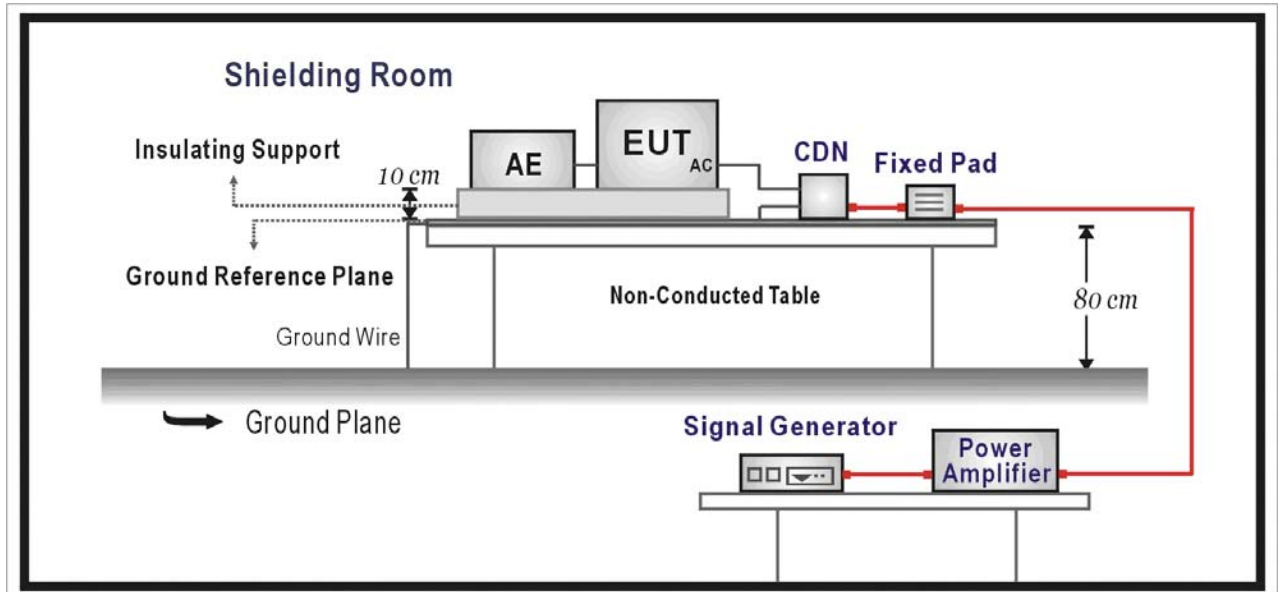

#### EM Clamp Test Mode

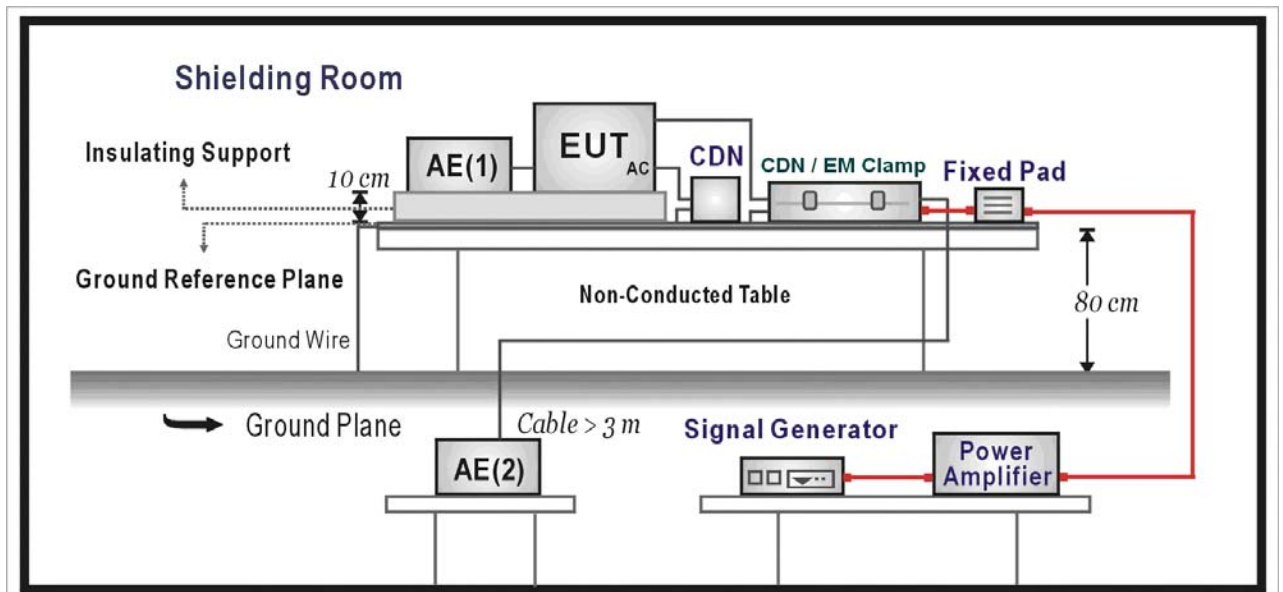

**12.3. Limit**

Item	Environmental Phenomena	Units	Test Specification	Performance Criteria
<b>Signal Ports and Telecommunication Ports</b>				
	Radio-Frequency Continuous Conducted	MHz V (rms, Un-modulated) % AM (1kHz)	0.15-80 3 80	A
<b>Input DC Power Ports</b>				
	Radio-Frequency Continuous Conducted	MHz V (rms, Un-modulated) % AM (1kHz)	0.15-80 3 80	A
<b>Input AC Power Ports</b>				
	Radio-Frequency Continuous Conducted	MHz V (rms, Un-modulated) % AM (1kHz)	0.15-80 3 80	A

**12.4. Test Procedure**

The EUT are placed on a table that is 0.8 meter height, and a Ground reference plane on the table, EUT are placed upon table and use a 10cm insulation between the EUT and Ground reference plane.

For Signal Ports and Telecommunication Ports

The disturbance signal is through a coupling and decoupling networks (CDN) or EM-clamp device couples to the signal and Telecommunication lines of the EUT.

For Input DC and AC Power Ports

The EUT is connected to the power mains through a coupling and decoupling networks for power supply lines. And directly couples the disturbances signal into EUT.

Used CDN-M2 for two wires or CDN-M3 for three wires.

All the scanning conditions are as follows:

Condition of Test	Remarks
1. Field Strength	130dBuV(3V) Level 2
2. Radiated Signal	AM 80% Modulated with 1kHz
3. Scanning Frequency	0.15MHz – 80MHz
4. Dwell Time	3 Seconds
5. Frequency step size $\Delta f$ :	1%
6. The rate of Swept of Frequency	$1.5 \times 10^{-3}$ decades/s

**12.5. Deviation from Test Standard**

No deviation.

**12.6. Test Result**

Product	Outdoor Bullet Network Camera		
Test Item	Conducted susceptibility		
Test Mode	Mode 1: Normal Operation (DC 12V)		
Date of Test	2011/04/17	Test Site	No.6 Shielded Room

Frequency Range (MHz)	Voltage Applied dBuV(V)	Inject Method	Tested Port of EUT	Required Criteria	Performance Criteria Complied To	Result
0.15~80	130 (3V)	CDN	AC IN	A	A	PASS
0.15~80	130 (3V)	Clamp	LAN	A	A	PASS

**Note:**

The testing performed is from lowest level up to the highest level as required by standard, but only highest level is shown on the report.

- Meet criteria A : Operate as intended during and after the test
- Meet criteria B : Operate as intended after the test
- Meet criteria C : Loss/Error of function
- Additional Information
  - EUT stopped operation and could / could not be reset by operator at \_\_\_\_\_ dBuV(V) at frequency \_\_\_\_\_MHz.
  - No false alarms or other malfunctions were observed during or after the test. The acceptance criteria were met, and the EUT passed the test.

Product	Outdoor Bullet Network Camera		
Test Item	Conducted susceptibility		
Test Mode	Mode 2: Normal Operation (AC 24V)		
Date of Test	2011/04/17	Test Site	No.6 Shielded Room

Frequency Range (MHz)	Voltage Applied dBuV(V)	Inject Method	Tested Port of EUT	Required Criteria	Performance Criteria Complied To	Result
0.15~80	130 (3V)	CDN	AC IN	A	A	PASS
0.15~80	130 (3V)	Clamp	LAN	A	A	PASS

**Note:**

The testing performed is from lowest level up to the highest level as required by standard, but only highest level is shown on the report.

- Meet criteria A : Operate as intended during and after the test
- Meet criteria B : Operate as intended after the test
- Meet criteria C : Loss/Error of function
- Additional Information
  - EUT stopped operation and could / could not be reset by operator at \_\_\_\_\_ dBuV(V) at frequency \_\_\_\_\_MHz.
  - No false alarms or other malfunctions were observed during or after the test. The acceptance criteria were met, and the EUT passed the test.

Product	Outdoor Bullet Network Camera		
Test Item	Conducted susceptibility		
Test Mode	Mode 3: Normal Operation (PoE)		
Date of Test	2011/04/17	Test Site	No.6 Shielded Room

Frequency Range (MHz)	Voltage Applied dBuV(V)	Inject Method	Tested Port of EUT	Required Criteria	Performance Criteria Complied To	Result
0.15~80	130 (3V)	Clamp	LAN	A	A	PASS

**Note:**

The testing performed is from lowest level up to the highest level as required by standard, but only highest level is shown on the report.

- Meet criteria A : Operate as intended during and after the test
- Meet criteria B : Operate as intended after the test
- Meet criteria C : Loss/Error of function
- Additional Information
  - EUT stopped operation and could / could not be reset by operator at \_\_\_\_\_ dBuV(V) at frequency \_\_\_\_\_MHz.
  - No false alarms or other malfunctions were observed during or after the test. The acceptance criteria were met, and the EUT passed the test.

## 12.7. Test Photograph

Test Mode : Mode 1: Normal Operation (DC 12V)

Description : Conducted Susceptibility Test Setup



Test Mode : Mode 1: Normal Operation (DC 12V)

Description : Conducted Susceptibility Test Setup-Clamp



Test Mode : Mode 2: Normal Operation (AC 24V)

Description : Conducted Susceptibility Test Setup



Test Mode : Mode 2: Normal Operation (AC 24V)

Description : Conducted Susceptibility Test Setup-Clamp



Test Mode : Mode 3: Normal Operation (PoE)

Description : Conducted Susceptibility Test Setup-Clamp





**13. Power Frequency Magnetic Field**

**13.1. Test Specification**

According to Standard : IEC 61000-4-8

**13.2. Test Setup**

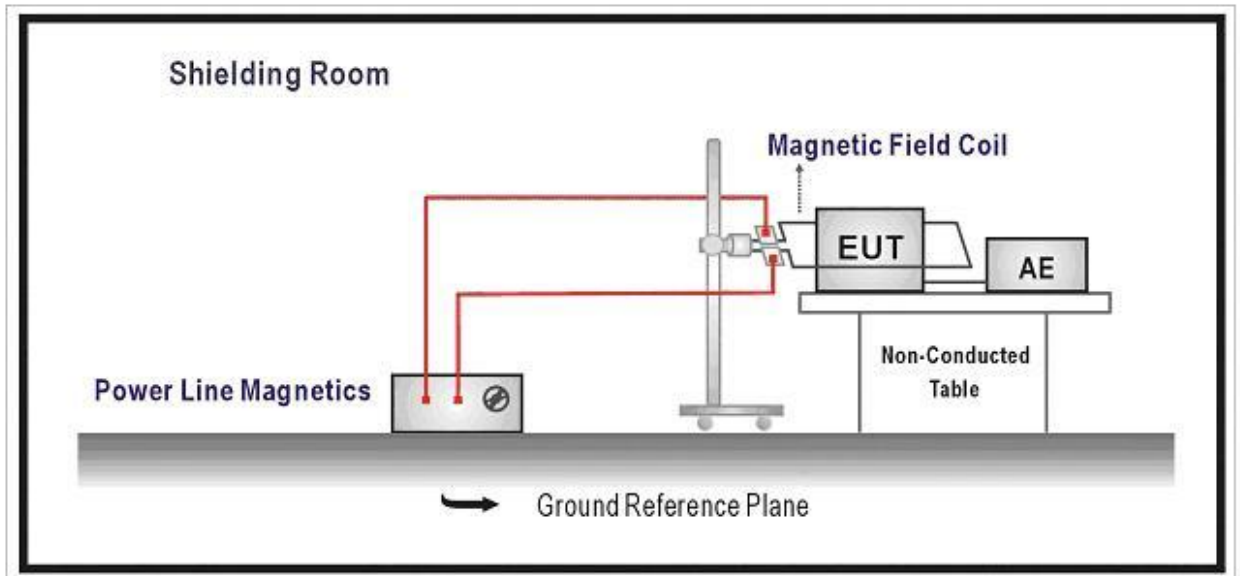

**13.3. Limit**

Item	Environmental Phenomena	Units	Test Specification	Performance Criteria
Enclosure Port				
	Power-Frequency Magnetic Field	Hz A/m (r.m.s.)	50 1	A

**13.4. Test Procedure**

The EUT and its load are placed on a table which is 0.8 meter above a metal ground plane measured at least 1m\*1m min. The test magnetic field shall be placed at central of the induction coil.

The test magnetic Field shall be applied 10 minutes by the immersion method to the EUT. And the induction coil shall be rotated by 90° in order to expose the EUT to the test field with different orientation (X, Y, Z Orientations).

**13.5. Deviation from Test Standard**

No deviation.

**13.6. Test Result**

Product	Outdoor Bullet Network Camera		
Test Item	Power frequency magnetic field		
Test Mode	Mode 1: Normal Operation (DC 12V)		
Date of Test	2011/04/17	Test Site	No.3 Shielded Room

Polarization	Frequency (Hz)	Magnetic Strength (A/m)	Required Performance Criteria	Performance Criteria Complied To	Test Result
X Orientation	50	1	A	A	PASS
Y Orientation	50	1	A	A	PASS
Z Orientation	50	1	A	A	PASS

- Meet criteria A: Operate as intended during and after the test
- Meet criteria B: Operate as intended after the test
- Meet criteria C: Loss/Error of function
- Additional Information
  - EUT stopped operation and could / could not be reset by operator at \_\_\_\_\_ kV of Line \_\_\_\_\_.
- No false alarms or other malfunctions were observed during or after the test. The acceptance criteria were met, and the EUT passed the test.

Product	Outdoor Bullet Network Camera		
Test Item	Power frequency magnetic field		
Test Mode	Mode 2: Normal Operation (AC 24V)		
Date of Test	2011/04/17	Test Site	No.3 Shielded Room

Polarization	Frequency (Hz)	Magnetic Strength (A/m)	Required Performance Criteria	Performance Criteria Complied To	Test Result
X Orientation	50	1	A	A	PASS
Y Orientation	50	1	A	A	PASS
Z Orientation	50	1	A	A	PASS

- Meet criteria A: Operate as intended during and after the test
- Meet criteria B: Operate as intended after the test
- Meet criteria C: Loss/Error of function
- Additional Information
  - EUT stopped operation and could / could not be reset by operator at \_\_\_\_\_ kV of Line \_\_\_\_\_.
- No false alarms or other malfunctions were observed during or after the test. The acceptance criteria were met, and the EUT passed the test.

Product	Outdoor Bullet Network Camera		
Test Item	Power frequency magnetic field		
Test Mode	Mode 3: Normal Operation (PoE)		
Date of Test	2011/04/17	Test Site	No.3 Shielded Room

Polarization	Frequency (Hz)	Magnetic Strength (A/m)	Required Performance Criteria	Performance Criteria Complied To	Test Result
X Orientation	50	1	A	A	PASS
Y Orientation	50	1	A	A	PASS
Z Orientation	50	1	A	A	PASS

- Meet criteria A: Operate as intended during and after the test
- Meet criteria B: Operate as intended after the test
- Meet criteria C: Loss/Error of function
- Additional Information
  - EUT stopped operation and could / could not be reset by operator at \_\_\_\_\_ kV of Line \_\_\_\_\_.
- No false alarms or other malfunctions were observed during or after the test. The acceptance criteria were met, and the EUT passed the test.

**13.7. Test Photograph**

Test Mode : Mode 1: Normal Operation (DC 12V)

Description : Power Frequency Magnetic Field Test Setup



Test Mode : Mode 2: Normal Operation (AC 24V)

Description : Power Frequency Magnetic Field Test Setup



Test Mode : Mode 3: Normal Operation (PoE)

Description : Power Frequency Magnetic Field Test Setup



## 14. Voltage Dips and Interruption

### 14.1. Test Specification

According to Standard : IEC 61000-4-11

### 14.2. Test Setup

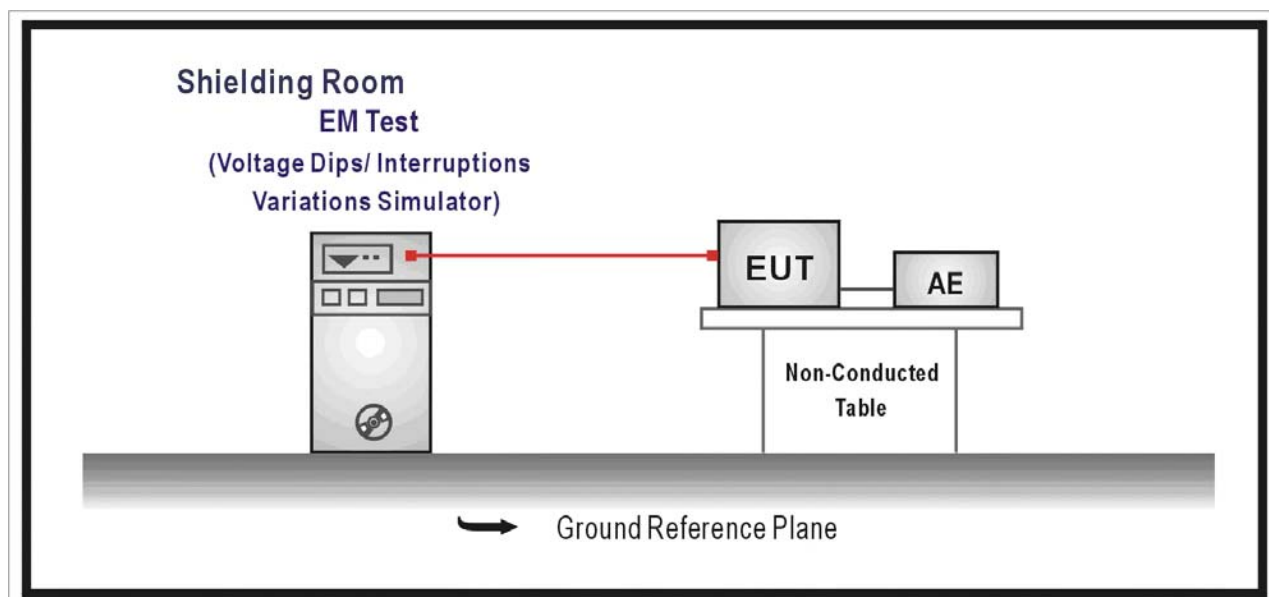

### 14.3. Limit

Item	Environmental Phenomena	Units	Test Specification	Performance Criteria
Input AC Power Ports				
	Voltage Dips	% Reduction	30	C
		Period	25	
	Voltage Interruptions	% Reduction	>95	B
		Period	0.5	
	Voltage Interruptions	% Reduction	> 95	C
		Period	250	

#### 14.4. Test Procedure

The EUT and its load are placed on a table which is 0.8 meter above a metal ground plane measured 1m\*1m min. And 0.65mm thick min. And projected beyond the EUT by at least 0.1m on all sides. The power cord shall be used the shortest power cord as specified by the manufacturer.

For Voltage Dips/ Interruptions test:

The selection of test voltage is based on the rated power range. If the operation range is large than 20% of lower power range, both end of specified voltage shall be tested.

Otherwise, the typical voltage specification is selected as test voltage.

The EUT is connected to the power mains through a coupling device that directly couples to the Voltage Dips and Interruption Generator.

The EUT shall be tested for 30% voltage dip of supplied voltage and duration 25 Periods, for 95% voltage dip of supplied voltage and duration 0.5 Periods with a sequence of three voltage dips with intervals of 10 seconds, and for 95% voltage interruption of supplied voltage and duration 250 Periods with a sequence of three voltage interruptions with intervals of 10 seconds.

Voltage phase shifting are shall occur at  $0^{\circ}$ ,  $45^{\circ}$ ,  $90^{\circ}$ ,  $135^{\circ}$ ,  $180^{\circ}$ ,  $225^{\circ}$ ,  $270^{\circ}$ ,  $315^{\circ}$  of the voltage.

#### 14.5. Deviation from Test Standard

No deviation.



**14.6. Test Result**

Product	Outdoor Bullet Network Camera		
Test Item	Voltage dips and interruption		
Test Mode	Mode 1: Normal Operation (DC 12V)		
Date of Test	2011/04/17	Test Site	No.3 Shielded Room

Voltage Dips and Interruption Reduction(%)	Angle	Test Duration (Periods)	Required Performance Criteria	Performance Criteria Complied To	Test Result
30	0	25	C	A	PASS
30	45	25	C	A	PASS
30	90	25	C	A	PASS
30	135	25	C	A	PASS
30	180	25	C	A	PASS
30	225	25	C	A	PASS
30	270	25	C	A	PASS
30	315	25	C	A	PASS
>95	0	0.5	B	A	PASS
>95	45	0.5	B	A	PASS
>95	90	0.5	B	A	PASS
>95	135	0.5	B	A	PASS
>95	180	0.5	B	A	PASS
>95	225	0.5	B	A	PASS
>95	270	0.5	B	A	PASS
>95	315	0.5	B	A	PASS
>95	0	250	C	B	PASS
>95	45	250	C	B	PASS
>95	90	250	C	B	PASS
>95	135	250	C	B	PASS
>95	180	250	C	B	PASS
>95	225	250	C	B	PASS
>95	270	250	C	B	PASS
>95	315	250	C	B	PASS

- Meet criteria A: Operate as intended during and after the test
- Meet criteria B: Operate as intended after the test
- Meet criteria C: Loss/Error of function
- Additional Information
  - The nominal voltage of EUT is 230V.
  - EUT stopped operation and could / could not be reset by operator at \_\_\_\_\_ kV of Line \_\_\_\_\_.
- No false alarms or other malfunctions were observed during or after the test. The acceptance criteria were met, and the EUT passed the test.

Product	Outdoor Bullet Network Camera		
Test Item	Voltage dips and interruption		
Test Mode	Mode 2: Normal Operation (AC 24V)		
Date of Test	2011/04/17	Test Site	No.3 Shielded Room

Voltage Dips and Interruption Reduction(%)	Angle	Test Duration (Periods)	Required Performance Criteria	Performance Criteria Complied To	Test Result
30	0	25	C	A	PASS
30	45	25	C	A	PASS
30	90	25	C	A	PASS
30	135	25	C	A	PASS
30	180	25	C	A	PASS
30	225	25	C	A	PASS
30	270	25	C	A	PASS
30	315	25	C	A	PASS
>95	0	0.5	B	A	PASS
>95	45	0.5	B	A	PASS
>95	90	0.5	B	A	PASS
>95	135	0.5	B	A	PASS
>95	180	0.5	B	A	PASS
>95	225	0.5	B	A	PASS
>95	270	0.5	B	A	PASS
>95	315	0.5	B	A	PASS
>95	0	250	C	B	PASS
>95	45	250	C	B	PASS
>95	90	250	C	B	PASS
>95	135	250	C	B	PASS
>95	180	250	C	B	PASS
>95	225	250	C	B	PASS
>95	270	250	C	B	PASS
>95	315	250	C	B	PASS

- Meet criteria A: Operate as intended during and after the test
- Meet criteria B: Operate as intended after the test
- Meet criteria C: Loss/Error of function
- Additional Information
  - The nominal voltage of EUT is 230V.
  - EUT stopped operation and could / could not be reset by operator at \_\_\_\_\_ kV of Line \_\_\_\_\_.
- No false alarms or other malfunctions were observed during or after the test. The acceptance criteria were met, and the EUT passed the test.

## 14.7. Test Photograph

Test Mode : Mode 1: Normal Operation (DC 12V)

Description : Voltage Dips Test Setup



Test Mode : Mode 2: Normal Operation (AC 24V)

Description : Voltage Dips Test Setup



15. Attachment

➤ EUT Photograph

(1) EUT Photo



(2) EUT Photo



(3) EUT Photo



(4) EUT Photo



(5) EUT Photo

