



Test Report

Product Name	Network Camera
Model No.	PZ8111W, PZ8121W

Applicant	VIVOTEK INC.
Address	6F, No.192, Lien-Cheng Rd., Chung-Ho, New Taipei City, 235, Taiwan, R.O.C.

Date of Receipt	Jun. 23, 2011
Issued Date	Aug. 26, 2011
Report No.	116381R-RFCEP76V01
Report Version	V1.0

The Test Results relate only to the samples tested.

The test report shall not be reproduced except in full without the written approval of Quietek Corporation.

Performed Location: Quietek Corporation (Linkou Laboratory)

No. 5-22, Rueishu Keng, Linkou Dist., New Taipei City 24451, Taiwan. R.O.C.

TEL:+866-2-8601-3788 / FAX:+886-2-8601-3789

Test Report Certification

Issued Date: Aug. 26, 2011

Report No.: 116381R-RFCEP76V01



Accredited by DNV, Nemko and NIST (NVLAP)

Product Name	Network Camera
Applicant	VIVOTEK INC.
Address	6F, No.192, Lien-Cheng Rd., Chung-Ho, New Taipei City, 235, Taiwan, R.O.C.
Manufacturer	VIVOTEK INC.
Model No.	PZ8111W, PZ8121W
EUT Rated Voltage	AC 100-240V, 50-60Hz
EUT Test Voltage	AC 230V/50Hz
Trade Name	VIVOTEK
Applicable Standard	ETSI EN 301 489-17:V2.1.1 (2009-05) ETSI EN 301 489-1: V1.8.1 (2008-04)
Test Result	Complied

The test results relate only to the samples tested.

The test report shall not be reproduced except in full without the written approval of QuieTek Corporation.

Documented By :



(Adm. Specialist / Joanne Lin)



Tested By :



(Assistant Engineer / Jack Hsu)



Approved By :



(Manager / Vincent Lin)



TABLE OF CONTENTS

Description	Page
1. GENERAL INFORMATION	5
1.1. EUT Description	5
1.2. Tested System Details	7
1.3. Configuration of tested System	7
1.4. EUT Exercise Software	8
1.5. Test Facility	9
2. Conducted Emission	10
2.1. Test Equipmen	10
2.2. Test Setup	10
2.3. Limits	11
2.4. Test Procedure	12
2.5. Test Specification	12
2.6. Uncertainty	12
2.7. Test Result	12
3. Radiated Emission	13
3.1. Test Equipment	13
3.2. Test Setup	14
3.3. Limits	15
3.4. Test Procedure	16
3.5. Test Specification	16
3.6. Uncertainty	16
3.7. Test Result	16
4. Power Harmonics, Voltage Fluctuation and Flicker	17
4.1. Test Equipment	17
4.2. Test Setup	17
4.3. Limits	17
4.4. Test Procedure	18
4.5. Test Specification	18
4.6. Uncertainty	18
4.7. Test Result	18
5. Electrostatic Discharge (ESD)	19
5.1. Test Equipment	19
5.2. Test Setup	19
5.3. Test Level	19
5.4. Test Procedure	20
5.5. Test Specification	20
5.6. Uncertainty	20
5.7. Test Result	20
6. Radiated Susceptibility (RS).....	21
6.1. Test Equipment	21
6.2. Test Setup	21
6.3. Test Level	21
6.4. Test Procedure	22
6.5. Test Specification	22
6.6. Uncertainty	22
6.7. Test Result	22
7. Electrical Fast Transient/Burst (EFT/B)	23
7.1. Test Equipment	23
7.2. Test Setup	23
7.3. Test Level	24
7.4. Test Procedure	24

7.5.	Test Specification	24
7.6.	Uncertainty	24
7.7.	Test Result	24
8.	Surge.....	25
8.1.	Test Equipment.....	25
8.2.	Test Setup	25
8.3.	Test Level	25
8.4.	Test Procedure	26
8.5.	Test Specification	26
8.6.	Uncertainty	26
8.7.	Test Result	26
9.	Conducted Susceptibility (CS).....	27
9.1.	Test Equipment.....	27
9.2.	Test Setup	27
9.3.	Test Level	27
9.4.	Test Procedure	28
9.5.	Test Specification	28
9.6.	Uncertainty	28
9.7.	Test Result	28
10.	Voltage Dips and Interruption.....	29
10.1.	Test Equipment.....	29
10.2.	Test Setup	29
10.3.	Test Level	29
10.4.	Test Procedure	30
10.5.	Test Specification	30
10.6.	Uncertainty	30
10.7.	Test Result	30
11.	EMC Reduction Method During Compliance Testing	31
12.	Test Result	32
12.1.	Test Data of Conducted Emission	33
12.2.	Test Data of Radiated Emission	37
12.3.	Test Data of Power Harmonics, Voltage Flucturation and Flicker	39
12.4.	Test Data of Electrostatic Discharge	42
12.5.	Test Data of Radiated Susceptibility	43
12.6.	Test Data of Electrical Fast Transient.....	44
12.7.	Test Data of Surge	45
12.8.	Test Data of Conducted Susceptibility	46
12.9.	Test Data of Voltage Dips and Interruption	47
Attachment 1: EUT Test Photographs		
Attachment 2: EUT Detailed Photographs		

1. GENERAL INFORMATION

1.1. EUT Description

Product Name	Network Camera
Trade Name	VIVOTEK
Model No.	PZ8111W, PZ8121W
Frequency Range	2412-2472MHz for 802.11b/g/n-20BW, 2422-2462MHz for 802.11n-40BW
Number of Channels	802.11b/g/n-20MHz: 13, n-40MHz: 9
Maximum Data Rate	802.11b: 1-11Mbps, 802.11g: 6-54Mbps, 802.11n: up to 150Mbps
Channel Separation	802.11b/g/n: 5 MHz
Type of Modulation	802.11b:DSSS, DBPSK, DQPSK, CCK 802.11g/n:OFDM, BPSK, QPSK, 16QAM, 64QAM
Channel Control	Auto
Antenna Gain	Refer to the table "Antenna List"
Antenna Type	Dipole
Power Adapter	MFR: ENG, M/N: 3A-183WP12 Input: AC 100-240V, 50-60Hz, 0.6A Output: DC 12V, 1.5A Cable Out: Non-Shielded, 1.6m

Antenna List

No.	Manufacturer	Model No.	Antenna Type	Peak Gain
1	WANSHIH	SOW1670A1	Dipole Antenna	2.1 dBi in 2.4 GHz

NOTE: Only the higher gain antenna was tested and recorded in this report.

802.11b/g/n-20MHz Center Frequency of Each Channel:

Channel	Frequency	Channel	Frequency	Channel	Frequency	Channel	Frequency
Channel 01:	2412 MHz	Channel 02:	2417 MHz	Channel 03:	2422 MHz	Channel 04:	2427 MHz
Channel 05:	2432 MHz	Channel 06:	2437 MHz	Channel 07:	2442 MHz	Channel 08:	2447 MHz
Channel 09:	2452 MHz	Channel 10:	2457 MHz	Channel 11:	2462 MHz	Channel 12:	2467 MHz
Channel 13:	2472 MHz						

802.11n-40MHz Center Frequency of Each Channel:

Channel	Frequency	Channel	Frequency	Channel	Frequency	Channel	Frequency
Channel 01:	2422 MHz	Channel 02:	2427 MHz	Channel 03:	2432 MHz	Channel 04:	2437 MHz
Channel 05:	2442 MHz	Channel 06:	2447 MHz	Channel 07:	2452 MHz	Channel 08:	2457 MHz
Channel 09:	2462 MHz						

Note:

- The different of each model is shown as below:

Model Number	PZ8111W	PZ8121W
Sensor	NTSC	PAL
POE	NO	NO
WLAN	YES	YES

- Quietek verified the construction and function in typical operation. All the test modes were carried out with the EUT in normal operation, which was shown in this test report and defined as:

EMI Mode	Mode 1: Normal Operation
EMS Mode	Mode 1: Normal Operation

1.2. Tested System Details

The types for all equipment, plus descriptions of all cables used in the tested system (including inserted cards) are:

Product	Manufacturer	Model No.	Serial No.	Power Cord
1 Monitor	JVC	LT-20BW7BJ	N/A	Non-Shielded, 1.8m
2 Microphone & Earphone	Ergotech	ET-E201	N/A	N/A
3 Notebook PC	DELL	PP04X	C8YYM1S	Non-Shielded, 1.8m

Signal Cable Type	Signal cable Description
A AV Cable	Non-Shielded, 1.5m
B Microphone & Earphone Cable	Non-Shielded, 1.6m
C LAN Cable	Non-Shielded, 3m

1.3. Configuration of tested System

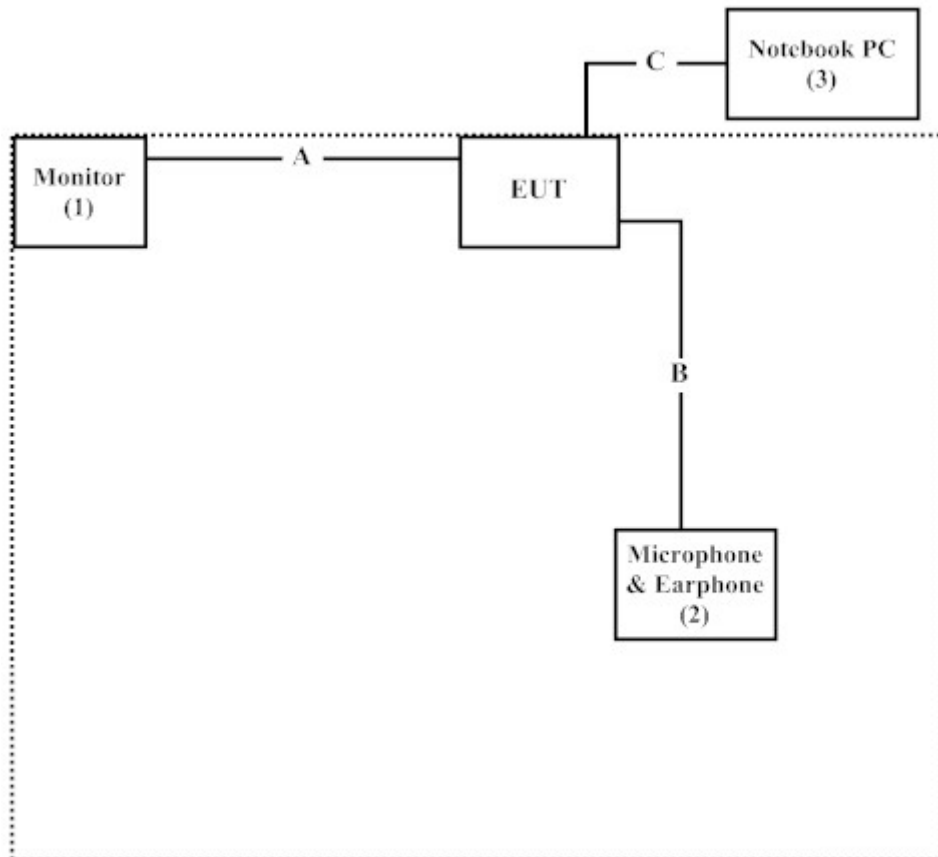

1.4. EUT Exercise Software

- (1) Setup the EUT and peripherals as shown in section 1.3.
- (2) Turn on the power of all equipments.
- (3) The EUT and the Notebook will show the transmitting and receiving characteristics when the communication is success.
- (4) The wireless LAN function is used to perform the wireless data transmission.
- (5) Repeat the step 3 and 4.

1.5. Test Facility

Ambient conditions in the laboratory:

Items	Test Item	Required	Actual
Temperature (°C)	IEC 61000-4-2	15-35	20
Humidity (%RH)		30-60	50
Barometric pressure (mbar)		860-1060	950-1000
Temperature (°C)	IEC 61000-4-3	15-35	20
Humidity (%RH)		25-75	50
Barometric pressure (mbar)		860-1060	950-1000
Temperature (°C)	IEC 61000-4-4	15-35	21
Humidity (%RH)		25-75	51
Barometric pressure (mbar)		860-1060	950-1000
Temperature (°C)	IEC 61000-4-5	15-35	21
Humidity (%RH)		10-75	51
Barometric pressure (mbar)		860-1060	950-1000
Temperature (°C)	IEC 61000-4-6	15-35	20
Humidity (%RH)		25-75	50
Barometric pressure (mbar)		860-1060	950-1000
Temperature (°C)	IEC 61000-4-11	15-35	21
Humidity (%RH)		25-75	51
Barometric pressure (mbar)		860-1060	950-1000

The related certificate for our laboratories about the test site and management system can be downloaded from Quietek Corporation’s Web Site : <http://www.quietek.com/tw/ctg/cts/accreditations.htm>

The address and introduction of Quietek Corporation’s laboratories can be founded in our Web site : <http://www.quietek.com/>

Site Description: Accredited by NVLAP
NVLAP Lab Code: 200533-0



Accredited by DNV
Statement No. : 413-99-LAB11



Accredited by Nemko
Certificate No.: ELA 165



Accredited by TUV Rheinland
Certificate No.: 10011438-1-2010



Accredited by TAF
Accredited Number: 0914

Site Name: Quietek Corporation
Site Address: No.5-22, Ruishukeng,
Linkou Dist. New Taipei City 24451,
Taiwan, R.O.C.
TEL : 886-2-8601-3788 / FAX : 886-2-8601-3789
E-Mail : service@quietek.com



2. Conducted Emission

2.1. Test Equipmen

The following test equipment are used during the conducted emission test:

Item	Equipment	Manufacturer	Model No. / Serial No.	Last Cal.	Remark
1	Test Receiver	R & S	ESCS 30 / 825442/018	Sep., 2010	
2	Artificial Mains Network	R & S	ENV4200 / 848411/10	Feb., 2011	Peripherals
3	LISN	R & S	ESH3-Z5 / 825562/002	Feb., 2011	EUT
4	Pulse Limiter	R & S	ESH3-Z2 / 357.8810.52	Feb., 2011	
5	4-wire ISN	R & S	ENY41 / 837032/001	Feb., 2011	
6	Double 2-Wire ISN	R & S	ENY22 / 835354/008	Feb., 2011	
7	No.1 Shielded Room				

Note: All equipments are calibrated every one year.

2.2. Test Setup

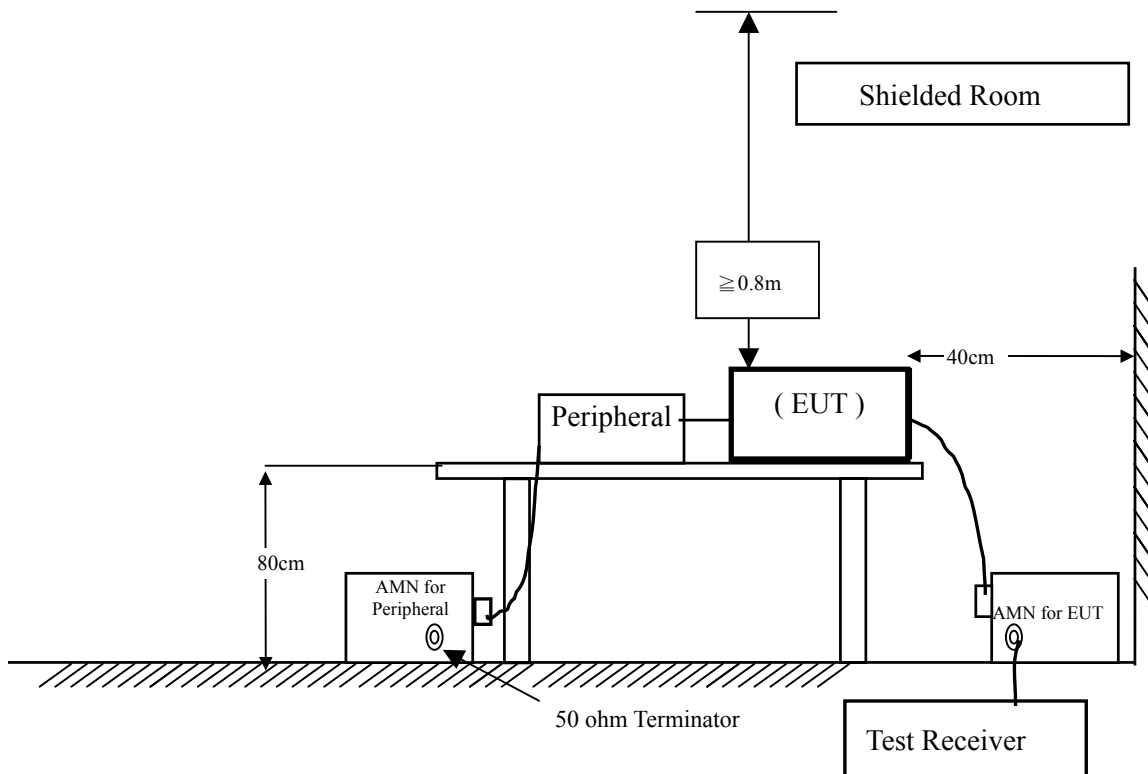

2.3. Limits

(1) Mains terminal

Frequency MHz	Limits (dBuV)			
	Limit for conducted emissions of equipment intended to be used in telecommunication centers only		Limit for conducted emissions	
	QP	AV	QP	AV
0.15 - 0.50	79	66	66-56	56-46
0.50-5.0	73	60	56	46
5.0 - 30	73	60	60	50

Remarks: The limit decreases linearly with the logarithm of the frequency in the range 0.15 MHz ~ 0.50 MHz.

(2) Telecommunication ports

Frequency MHz	Limits (dBuV)			
	Limit for conducted emissions from telecommunication ports of equipment intended for use in telecommunication centers only		Limit for conducted emissions from telecommunication ports	
	QP	AV	QP	AV
0.15 – 0.50	97-87	84-74	84-74	74-64
5.0 – 30	87	74	74	64

Remarks: In the above table, the tighter limit applies at the band edges.

2.4. Test Procedure

AC Mains:

The EUT and simulators are connected to the main power through a line impedance stabilization network (L.I.S.N.). This provides a 50 ohm /50uH coupling impedance for the measuring equipment. The peripheral devices are also connected to the main power through a LISN that provides a 50ohm /50uH coupling impedance with 50ohm termination. (Please refers to the block diagram of the test setup and photographs.)

Both sides of AC line are checked for maximum conducted interference. In order to find the maximum emission, the relative positions of equipment and all of the interface cables must be changed according to ETSI EN 301489-1: V1.8.1 (2008-04) on conducted measurement.

The bandwidth of the field strength meter (R & S Test Receiver ESCS 30) is set at 9kHz.

Telecommunication Port:

The mains voltage shall be supplied to the EUT via the LISN when the measurement of telecommunication port is performed. The common mode disturbances at the telecommunication port shall be connected to the ISN, which is 150ohm impedance. Both alternative cables are tested related to the LCL requested. The measurement range is from 150kHz to 30MHz. The bandwidth of measurement is set to 9kHz. The 60dB LCL ISN is used for cat. 5 cable, 50dB LCL ISN is used for cat. 3 and 80dB LCL is wed for alternative one.

2.5. Test Specification

According to ETSI EN 301489-1: V1.8.1 (2008-04)

EN 55022: 2006+A1: 2007

2.6. Uncertainty

± 2.26 dB

2.7. Test Result

The emission from the EUT was below the specified limits. The worst-case emissions are shown in section 12. The EUT complies the acceptance criterion and passes the test.

3. Radiated Emission

3.1. Test Equipment

The following test equipment are used during the Radiated emission test:

Test Site	Equipment	Manufacturer	Model No./Serial No.	Last Cal.
<input type="checkbox"/> Site # 1	Test Receiver	R & S	ESVS 10 / 834468/003	July, 2011
	Spectrum Analyzer	Advantest	R3162/ 00803480	May, 2011
	Pre-Amplifier	Advantest	BB525C/ 3307A01812	May, 2011
	Bilog Antenna	SCHAFFNER	CBL6112B / 2697	Nov., 2010
<input type="checkbox"/> Site # 2	Test Receiver	R & S	ESCS 30 / 836858 / 022	Nov., 2010
	Spectrum Analyzer	Advantest	R3162 / 100803466	May, 2011
	Pre-Amplifier	Advantest	BB525C/3307A01814	May, 2011
	Bilog Antenna	SCHAFFNER	CBL6112B / 2705	Oct., 2010
	Horn Antenna	ETS	3115 / 0005-6160	July, 2011
	Pre-Amplifier	QTK	QTK-AMP-01/ 0001	July, 2011
<input checked="" type="checkbox"/> Site # 3	Test Receiver	R & S	ESI 26 / 838786 / 004	May, 2011
	Spectrum Analyzer	Advantest	R3162 / 100803480	May, 2011
	Pre-Amplifier	QTK	QTK-AMP-03 / 0003	May, 2011
	Bilog Antenna	SCHAFFNER	CBL6112B / 2697	May, 2011
	Horn Antenna	ETS	3115 / 0005-6160	July, 2011
	Pre-Amplifier	QTK	QTK-AMP-01 / 0001	July, 2011
	Pre-Amplifier	QTK	AP-180C / CHM_0906076	Sep., 2010

- Note:
1. All equipments are calibrated every one year.
 2. The test instruments marked by "X" are used to measure the final test results.

3.2. Test Setup

Radiated Emission Below 1GHz

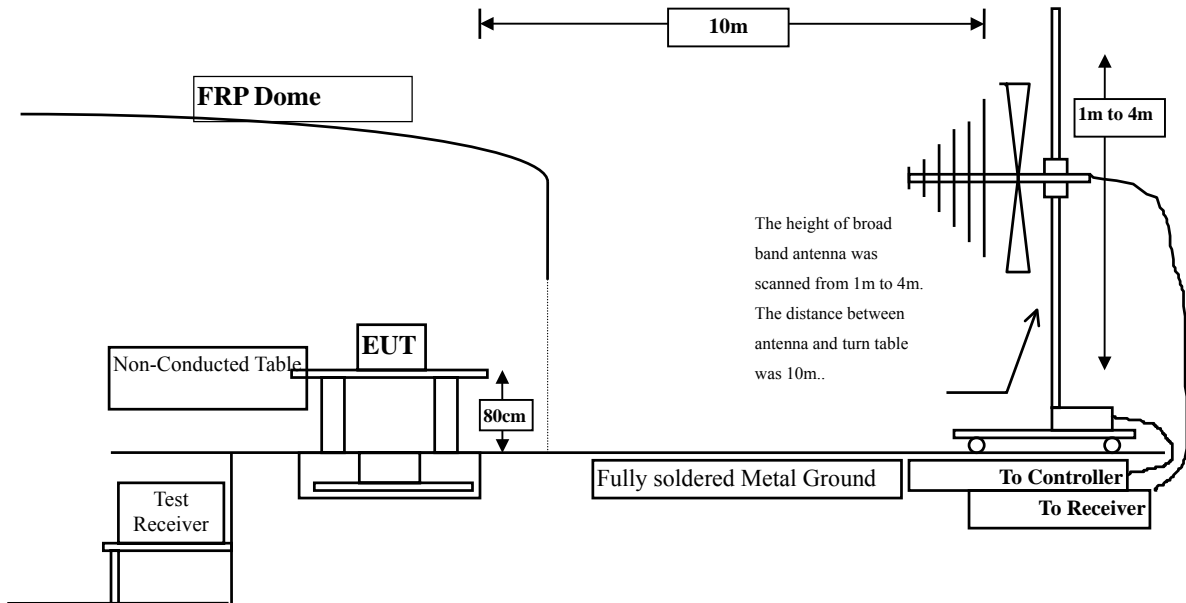

Radiated Emission Above 1GHz

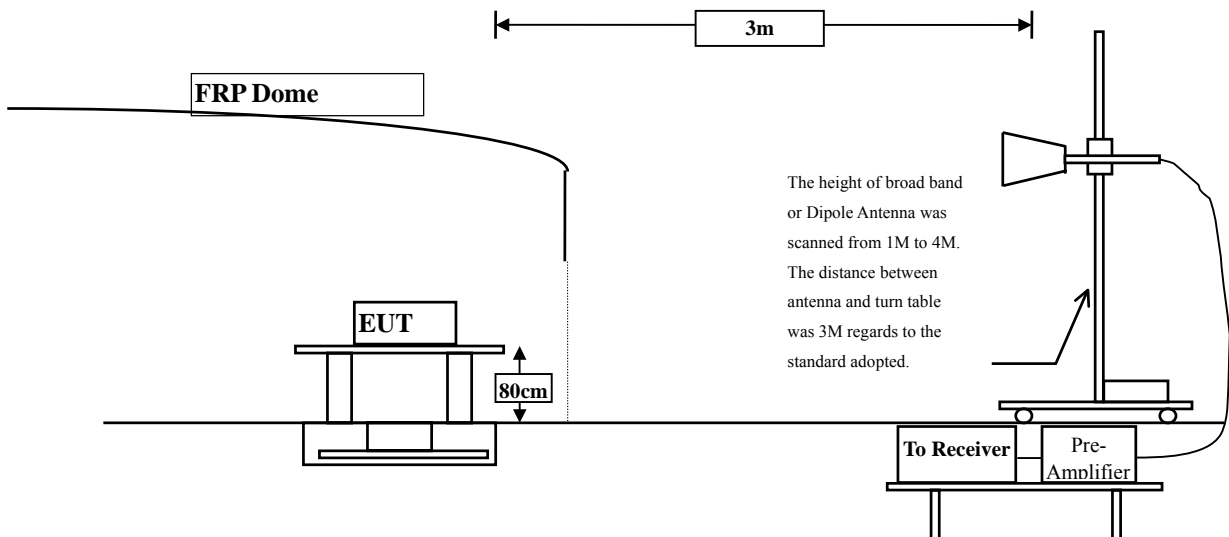

3.3. Limits

Limits for radiated disturbance under 1 GHz at a measurement distance of 10 m

Frequency MHz	Limits (dBuV/m)	
	Limit for radiated emissions from ancillary equipment intended for use in telecommunication centers only, and measured on a stand alone basis	Limit for radiated emissions from ancillary equipment, measured on a stand alone basis
	QP	QP
30-230	40	30
230-1000	47	37

Limits for radiated disturbance above 1 GHz at a measurement distance of 3 m

Frequency range	Average Limit (dB μ V/m)	Peak limit (dB μ V/m)
1 000 MHz to 3 000 MHz	50	70
3 000 MHz to 6 000 MHz	54	74
NOTE: The lower limit applies at the transition frequency.		

Limits above 1 GHz for radiated emissions from ancillary equipment intended for use in telecommunication centres only, and measured on a stand alone basis at a measurement distance of 3 m

Frequency range	Average Limit (dB μ V/m)	Peak limit (dB μ V/m)
1 000 MHz to 3 000 MHz	56	76
3 000 MHz to 6 000 MHz	60	80
NOTE: The lower limit applies at the transition frequency.		

3.4. Test Procedure

The EUT and its simulators are placed on a turn table which is 0.8 meter above ground. The turn table can rotate 360 degrees to determine the position of the maximum emission level. The EUT was positioned such that the distance from antenna to the EUT was 10 meters.

The antenna can move up and down between 1 meter and 4 meters to find out the maximum emission level.

Both horizontal and vertical polarization of the antenna are set on measurement. In order to find the maximum emission, all of the interface cables must be manipulated on radiated measurement.

Radiated emissions were investigated over the frequency range from 30MHz to 1GHz using a receiver bandwidth of 120kHz. Radiated was performed at an antenna to EUT distance of 10 meters.

Radiated emissions were investigated over the frequency range from 1GHz to 6GHz using a receiver bandwidth of 1MHz. Radiated was performed at an antenna to EUT distance of 3 meters.

3.5. Test Specification

According to ETSI EN 301489-1: V1.8.1 (2008-04)

EN 55022: 2006+A1: 2007

3.6. Uncertainty

± 3.19 dB

3.7. Test Result

The emission from the EUT was below the specified limits. The worst-case emissions are shown in section 12. The EUT complies the acceptance criterion and passes the test.

4. Power Harmonics, Voltage Fluctuation and Flicker

4.1. Test Equipment

Instrument	Manufacturer	Type No.	Serial No	Cal. Date
AC Power Source(Harmonic)	Schaffner	NSG 1007	HK54148	2011/08/11
IEC1000-4-X Analyzer(Flicker)	Schaffner	CCN 1000-1	X7 1887	2011/08/11

Note: All equipments are calibrated every one year.

4.2. Test Setup

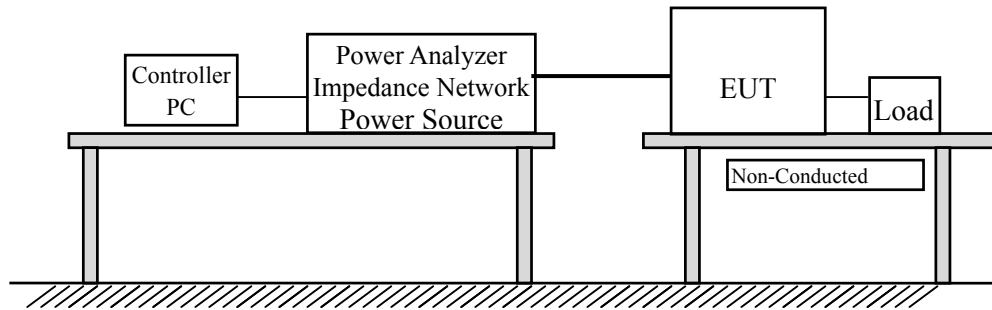

4.3. Limits

➤Limits of Class A Harmonics Currents

Harmonics Order n	Maximum Permissible harmonic current A	Harmonics Order n	Maximum Permissible harmonic current A
Odd harmonics		Even harmonics	
3	2.30	2	1.08
5	1.14	4	0.43
7	0.77	6	0.30
9	0.40	8 ≤ n ≤ 40	0.23 * 8/n
11	0.33		
13	0.21		
15 ≤ n ≤ 39	0.15 * 15/n		

➤Limits of Class B Harmonics Currents

For Class B equipment, the harmonic of the input current shall not exceed the maximum permissible values given in table that is the limit of Class A multiplied by a factor of 1.5.

➤Limits of Class C Harmonics Currents

Harmonics Order n	Maximum Permissible harmonic current Expressed as a percentage of the input current at the fundamental frequency %
2	2
3	$30 \cdot \lambda^*$
5	10
7	7
9	5
$11 \leq n \leq 39$ (odd harmonics only)	3

* λ is the circuit power factor

➤Limits of Class D Harmonics Currents

Harmonics Order n	Maximum Permissible harmonic current per watt mA/W	Maximum Permissible harmonic current A
3	3.4	2.30
5	1.9	1.14
7	1.0	0.77
9	0.5	0.40
11	0.35	0.33
$13 \leq n \leq 39$ (odd harmonics only)	$3.85/n$	See limit of Class A

4.4. Test Procedure

The EUT is supplied in series with power analyzer from a power source having the same normal voltage and frequency as the rated supply voltage and the equipment under test. And the rated voltage at the supply voltage of EUT of 0.94 times and 1.06 times shall be performed.

4.5. Test Specification

According to EN 61000-3-2:2006+A2: 2009, EN 61000-3-3:2008

4.6. Uncertainty

± 3.23 %

4.7. Test Result

The measurement of the power harmonics, which test at the extremes of EUT’s supply range, was investigated and test result was shown in section 12. The EUT complies the acceptance criterion and passes the test.

Test Result: (See Test Result)

<input checked="" type="checkbox"/> PASS	<input type="checkbox"/> FAIL
Note: According to clause 7 of EN 61000-3-2: 2006+A2: 2009, equipment with a rated power of 75W or less, no limits apply. The test result is only for reference.	

5. Electrostatic Discharge (ESD)

5.1. Test Equipment

	Instrument	Manufacturer	Type No.	Serial No	Cal. Date
	ESD Simulator System	SCHAFFNER	NSG 438	695	May, 2011
X	ESD Simulator System	NoiseKen	TC-815R	ESS0929097	Aug, 2011
	ESD Simulator System	Thermo	MZ-15/EC/ TPC-2A	0510189/ 0510190	June, 2011
	ESD Simulator System	EM TEST	dito	V0635101749	Sep, 2010
X	Horizontal Coupling Plane (HCP)	Quietek	HCP AL50	N/A	N/A
X	Vertical Coupling Plane (VCP)	Quietek	VCP AL50	N/A	N/A

Note: 1. All equipments are calibrated every one year.
 2. The test instruments marked by "X" are used to measure the final test results.

5.2. Test Setup

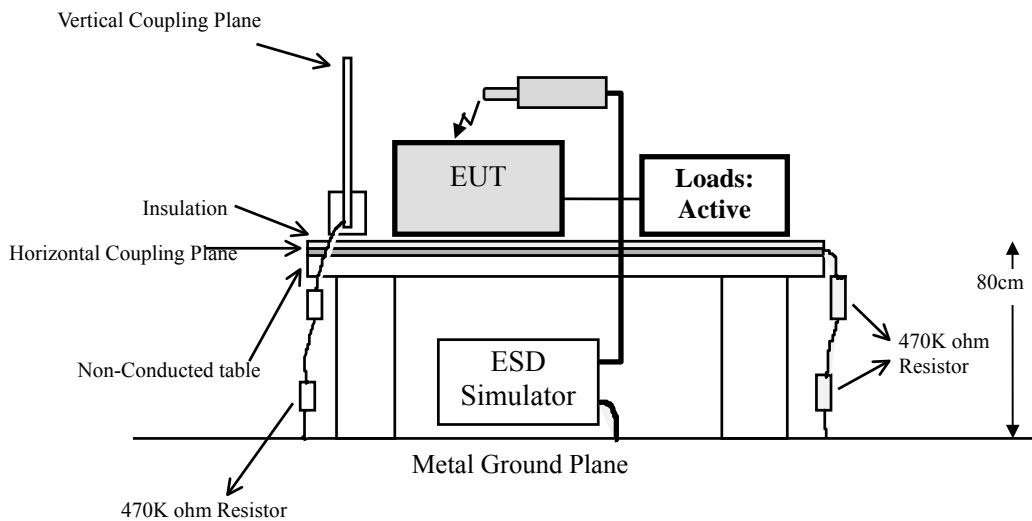

5.3. Test Level

Item	Environmental Phenomena	Units	Test Specification	Performance Criteria
Enclosure Port				
	Electrostatic Discharge	kV(Charge Voltage)	±8 Air Discharge ±4 Contact Discharge	B

5.4. Test Procedure

Direct application of discharges to the EUT:

Contact discharge was applied only to conductive surfaces of the EUT.

Air discharges were applied only to non-conductive surfaces of the EUT.

During the test, it was performed with single discharges. For the single discharge time between successive single discharges will be keep longer 1 second. It was at least ten single discharges with positive and negative at the same selected point.

The selected point, which was performed with electrostatic discharge, was marked on the red label of the EUT.

Indirect application of discharges to the EUT:

Vertical Coupling Plane (VCP):

The coupling plane, of dimensions 0.5m x 0.5m, is placed parallel to, and positioned at a distance 0.1m from, the EUT, with the Discharge Electrode touching the coupling plane.

The four faces of the EUT will be performed with electrostatic discharge. It was at least ten single discharges with positive and negative at the same selected point.

Horizontal Coupling Plane (HCP):

The coupling plane is placed under to the EUT. The generator shall be positioned vertically at a distance of 0.1m from the EUT, with the Discharge Electrode touching the coupling plane.

The four faces of the EUT will be performed with electrostatic discharge. It was at least ten single discharges with positive and negative at the same selected point.

5.5. Test Specification

According to IEC 61000-4-2: 2008

5.6. Uncertainty

The uncertainty of the voltage of the waveform is $\pm 1.0 \%$

The uncertainty of the timing of the waveform is $\pm 0.1\%$.

5.7. Test Result

The measurement of the electrostatic discharge was investigated and test result was shown in section 12. The EUT complies the acceptance criterion and passes the test.

6. Radiated Susceptibility (RS)

6.1. Test Equipment

Item	Equipment	Manufacturer	Model No. / Serial No.	Last Cal.
1	Signal Generator	R & S	SML03/103330	Sep., 2010
2	Power Amplifier	Schaffner	CBA9413B/4020	N/A
3	Power Amplifier	A & R	30S1G3/309453	N/A
4	Biconilog Antenna	EMCO	3149/00071675	N/A
5	Power Meter	R & S	NRVD / 100219	Jan., 2011
6	Directional Coupler	A & R	DC6180/22735	N/A
7	Directional Coupler	A & R	DC7144A/312249	N/A
8	No.2 EMC Fully Chamber			

Note: All equipments are calibrated every one year.

6.2. Test Setup

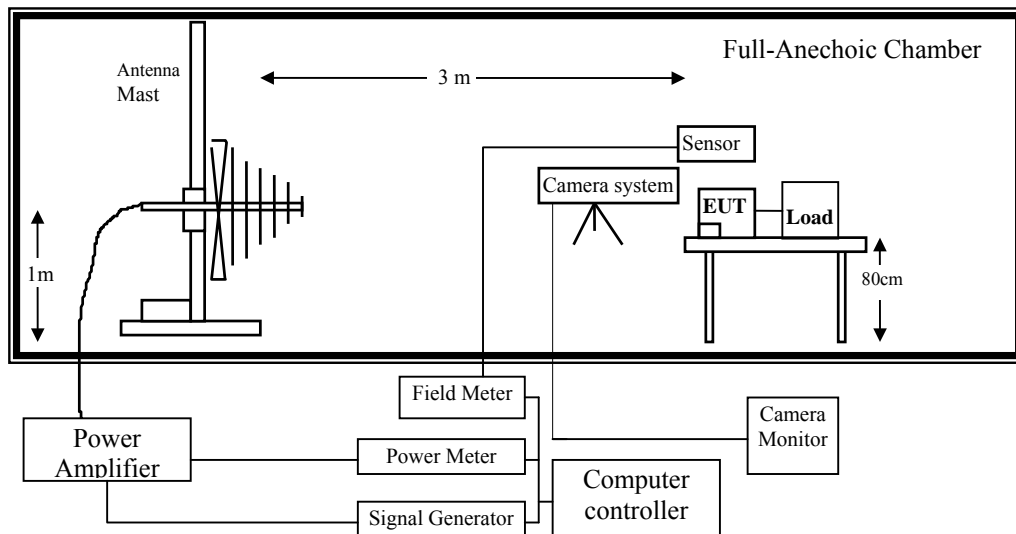

6.3. Test Level

Item	Environmental Phenomena	Units	Test Specification	Performance Criteria
Enclosure Port				
	Radio-Frequency	MHz	80-1000 1400-2700	A
	Electromagnetic Field	V/m(Un-modulated, rms)	3	
	Amplitude Modulated	% AM (1kHz)	80	

6.4. Test Procedure

The EUT and load, which are placed on a table that is 0.8 meter above ground, are placed with one coincident with the calibration plane such that the distance from antenna to the EUT was 3 meters.

Both horizontal and vertical polarization of the antenna and four sides of the EUT are set on measurement.

In order to judge the EUT performance, a CCD camera is used to monitor EUT screen.

All the scanning conditions are as follows:

Condition of Test	Remarks
1. Field Strength	3 V/m Level 2
2. Radiated Signal	AM 80% Modulated with 1kHz sinusoidal audio signal
3. Scanning Frequency	80MHz - 1000MHz, 1400MHz - 2700MHz
4. Dwell Time	3 Seconds
5. Frequency step size Δf :	1%
6. The rate of Swept of Frequency	1.5×10^{-3} decades/s

6.5. Test Specification

According to IEC 61000-4-3: 2010

6.6. Uncertainty

± 3.57 dB.

6.7. Test Result

The measurement of the radiated susceptibility was investigated and test result was shown in section 12. The EUT complies the acceptance criterion and passes the test.

7. Electrical Fast Transient/Burst (EFT/B)

7.1. Test Equipment

	Instrument	Manufacturer	Type No.	Serial No	Cal. Date
	Schaffner NSG 2050 System Mainframe	Schaffner	N/A	N/A	Jan, 2011
	EMC immunity system	Thermo	EMCPRO PLUS	0411225	Mar, 2011
X	TRANSIENT TEST SYSTEM	EMC PARTNET	TRA2000IN6	1138	Mar, 2011

- Note: 1. All equipments are calibrated every one year.
 2. The test instruments marked by "X" are used to measure the final test results.

7.2. Test Setup

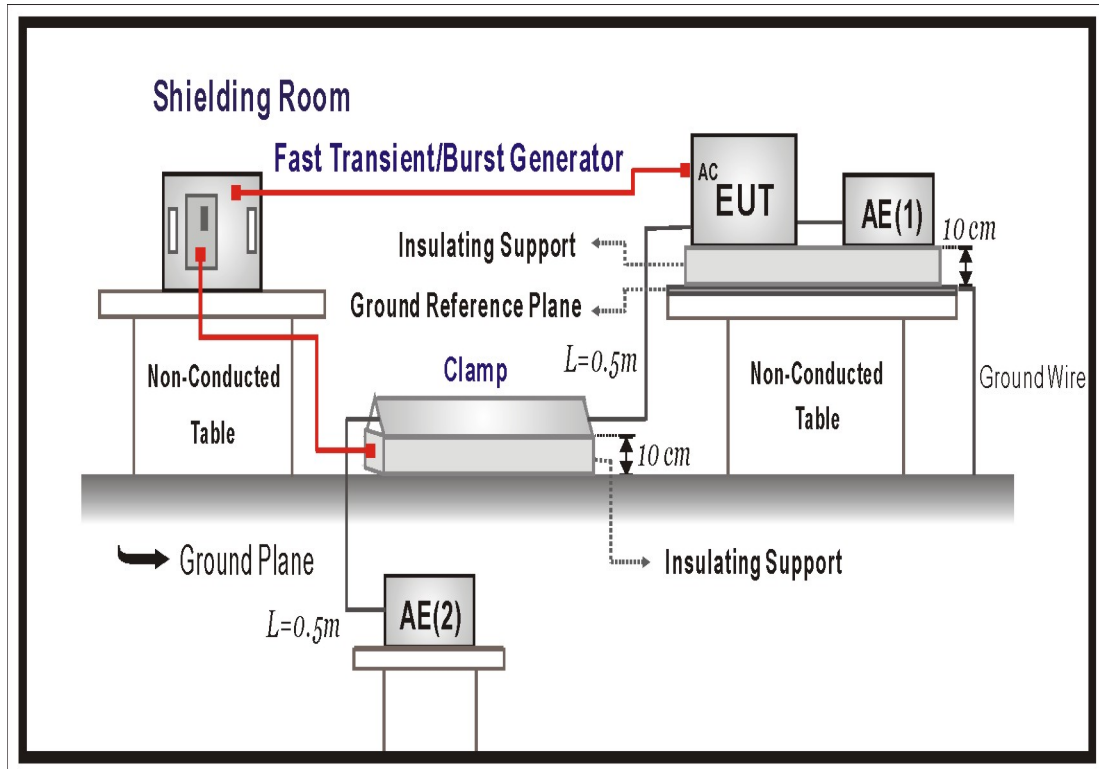

7.3. Test Level

Item	Environmental Phenomena	Units	Test Specification	Performance Criteria
Ports for signal lines and control lines				
	Fast Transients Common Mode	kV (Peak)	± 0.5	B
		Tr/Th ns	5/50	
		Rep. Frequency kHz	5	
Input DC Power Ports				
	Fast Transients Common Mode	kV (Peak)	± 0.5	B
		Tr/Th ns	5/50	
		Rep. Frequency kHz	5	
Input AC Power Ports				
	Fast Transients Common Mode	kV (Peak)	± 1	B
		Tr/Th ns	5/50	
		Rep. Frequency kHz	5	

7.4. Test Procedure

The EUT and load are placed on a table that is 0.8 meter above a metal ground plane measured 1m*1m min. and 0.65mm thick min. And projected beyond the EUT by at least 0.1m on all sides.
 For Signal Ports and Telecommunication Ports:

The EFT interference signal is through a coupling clamp device couples to the signal and control lines of the EUT with burst noise for 1min.

For Input DC and AC Power Ports:

The EUT is connected to the power mains through a coupling device that directly couples the EFT interference signal.

Each of the Line and Neutral conductors is impressed with burst noise for 1 min.

The length of power cord between the coupling device and the EUT shall be 1m.

7.5. Test Specification

According to IEC 61000-4-4: 2011

7.6. Uncertainty

The uncertainty of the voltage of the waveform is $\pm 4\%$

The uncertainty of the timing of the waveform is $\pm 2.5\%$.

7.7. Test Result

The measurement of the Electrical Fast Transient/Burst was investigated and test result was shown in section 12. The EUT complies the acceptance criterion and passes the test.

8. Surge

8.1. Test Equipment

	Instrument	Manufacturer	Type No.	Serial No	Cal. Date
	Schaffner NSG 2050 System Mainframe	Schaffner	N/A	N/A	Jan, 2011
	EMC immunity system	Thermo	EMC PRO PLUS	0411225	Mar, 2011
X	TRANSIENT TEST SYSTEM	EMC PARTNET	TRA2000IN6	1138	Mar, 2011

Note: 1. All equipments are calibrated every one year.
 2. The test instruments marked by “X” are used to measure the final test results.

8.2. Test Setup

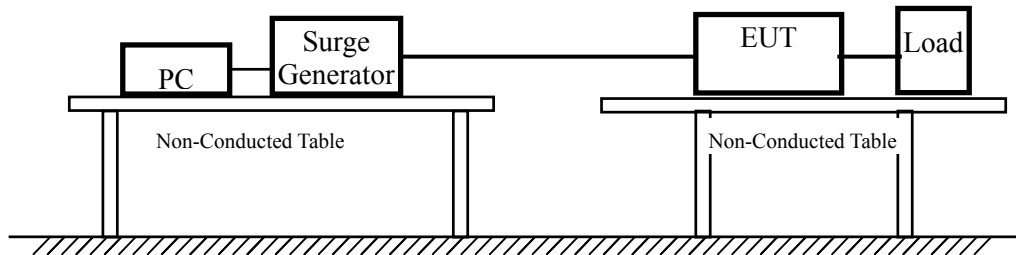

8.3. Test Level

Item	Environmental Phenomena	Units	Test Specification	Performance Criteria
Telecommunication Ports (See 1) and 2)				
	Surges Line to Ground	Tr/Th us kV	1.2/50 (8/20) ± 1	B
Telecommunication Ports in Telecom Centres (See 1) and 2)				
	Surges Line to Ground	Tr/Th us kV	1.2/50 (8/20) ± 0.5	B
AC Input and AC Output Power Ports				
	Surges Line to Line Line to Ground	Tr/Th us kV kV	1.2/50 (8/20) ±1 ± 2	B
AC Input and AC Output Power Ports in Telecom Centres				
	Surges Line to Line Line to Ground	Tr/Th us kV kV	1.2/50 (8/20) ±0.5 ± 1	B

Notes:

- 1) Applicable only to ports which according to the manufacturer’s may directly to outdoor cables.
- 2) Where normal functioning cannot be achieved because of the impact of the CDN on the EUT, no immunity test shall be required.

8.4. Test Procedure

The EUT and its load are placed on a table that is 0.8 meter above a metal ground plane measured 1m*1m min. and 0.65mm thick min. And projected beyond the EUT by at least 0.1m on all sides. The length of power cord between the coupling device and the EUT shall be 2m or less.

For Signal Ports and Telecommunication Ports

The disturbance signal is through a coupling and decoupling networks (CDN) device couples to the signal and Telecommunication lines of the EUT.

For Input and Output AC Power or DC Input and DC Output Power Ports:

The EUT is connected to the power mains through a coupling device that directly couples the Surge interference signal.

The surge noise shall be applied synchronized to the voltage phase at 0° , 90° , 180° , 270° and the peak value of the a.c. voltage wave. (Positive and negative)

Each of Line-Earth and Line-Line is impressed with a sequence of five surge voltages with interval of 1 min.

8.5. Test Specification

According to IEC 61000-4-5: 2005

8.6. Uncertainty

The uncertainty of the voltage of the waveform is 3.5 %

The uncertainty of the timing of the waveform is 0.1%.

8.7. Test Result

The measurement of the Surge was investigated and test result was shown in section 12. The EUT complies the acceptance criterion and passes the test.

9. Conducted Susceptibility (CS)

9.1. Test Equipment

Item	Equipment	Manufacturer	Model No. / Serial No.	Last Cal.
1	CS SYSTEM	SCHAFFNER	NSG 2070	March, 2011
2	CDN	SCHAFFNER	CDN M016S / 20822	Dec., 2010
3	CDN	SCHAFFNER	CDN M016S / 20823	Dec., 2010
4	FIXED PAD	SCHAFFNER	INA 2070-1 / 2115	N/A
5	EM Clamp		KEMZ 801 / 21024	March, 2011
6	No.6 Shielded Room			

Note: All equipments are calibrated every one year.

9.2. Test Setup

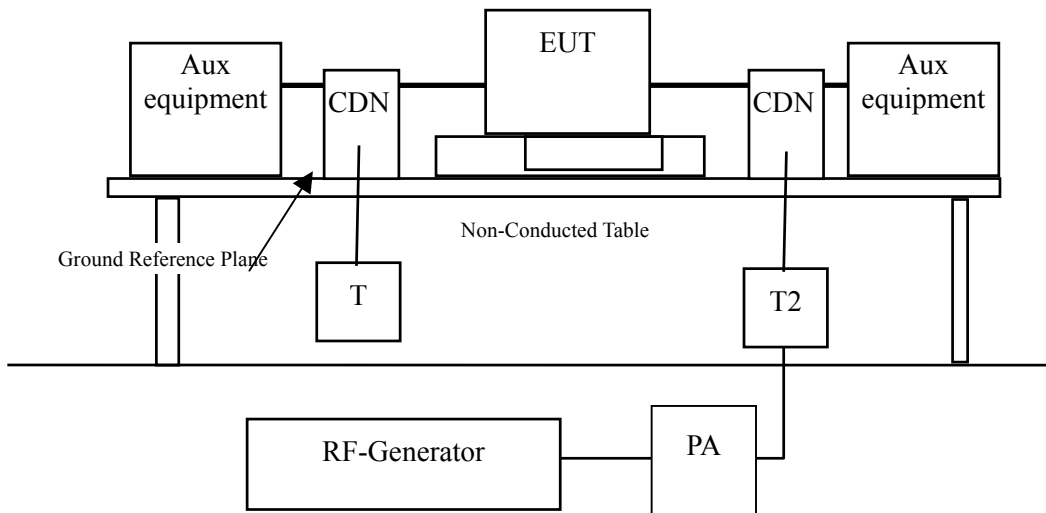

9.3. Test Level

Item	Environmental Phenomena	Units	Test Specification	Performance Criteria
AC Input and AC Output & DC Input and DC output Power Ports & Functional Earth Ports				
	Radio-Frequency	MHz	0.15-80	A
	Common Mode.	V (rms, Unmodulated)	3	
	Amplitude Modulated	% AM (1kHz)	80	
		Source Impedance Ω	150	

9.4. Test Procedure

The EUT are placed on a table that is 0.8 meter height, and a Ground reference plane on the table, EUT are placed upon table and use a 10cm insulation between the EUT and Ground reference plane.

For Signal Ports and Telecommunication Ports

The disturbance signal is through a coupling and decoupling networks (CDN) or EM-clamp device couples to the signal and Telecommunication lines of the EUT.

For Input DC and AC Power Ports

The EUT is connected to the power mains through a coupling and decoupling networks for power supply lines. And directly couples the disturbances signal into EUT.

Used CDN-M2 for two wires or CDN-M3 for three wires.

All the scanning conditions are as follows:

Condition of Test	Remarks
1. Field Strength	130dBuV(3V) Level 2
2. Radiated Signal	AM 80% Modulated with 1kHz sinusoidal audio signal
3. Scanning Frequency	0.15MHz – 80MHz
4 Dwell Time	3 Seconds
5. Frequency step size Δf :	1%
6. The rate of Swept of Frequency	1.5×10^{-3} decades/s

9.5. Test Specification

According to IEC 61000-4-6: 2008

9.6. Uncertainty

The uncertainty of the injected modulated signal level through CDN is ± 2.0 dB

The uncertainty of the injected modulated signal level through EM Clamp/Direct Injection is ± 2.61 dB.

9.7. Test Result

The measurement of the Conducted Susceptibility was investigated and test result was shown in section 12. The EUT complies the acceptance criterion and passes the test.

10. Voltage Dips and Interruption

10.1. Test Equipment

	Instrument	Manufacturer	Type No.	Serial No	Cal. Date
	Schaffner NSG 2050 System Mainframe	Schaffner	N/A	N/A	Jan, 2011
	EMC immunity system	Thermo	EMCPRO PLUS	0411225	Mar, 2011
X	TRANSIENT TEST SYSTEM	EMC PARTNET	TRA2000IN6	1138	Mar, 2011

- Note:
1. All equipments are calibrated every one year.
 2. The test instruments marked by “X” are used to measure the final test results.

10.2. Test Setup

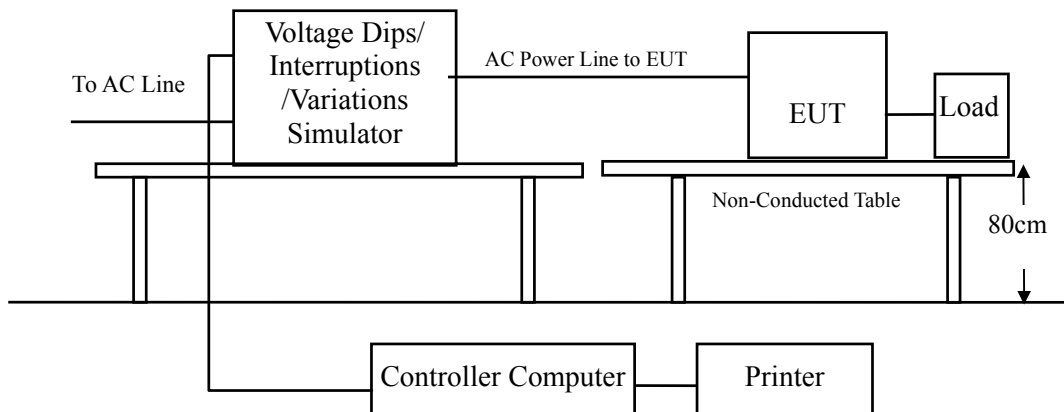

10.3. Test Level

Item	Environmental Phenomena	Units	Test Specification	Performance Criteria
AC Input and AC Output Power Ports				
	Voltage Dips	% Reduction (Cycle)	100 % 0.5	B
	Voltage Dips	% Reduction (Cycle)	100 % 1	B
	Voltage Dips	% Reduction (Cycle)	30 % 25	B
	Voltage Interruptions	% Reduction (Cycle)	100 % 250	C (see note)

NOTE: Equipment is fitted with or connected to a battery back-up, the performance criteria is “B”.

10.4. Test Procedure

The EUT and its load are placed on a table which is 0.8 meter above a metal ground plane measured 1m*1m min. and 0.65mm thick min. And projected beyond the EUT by at least 0.1m on all sides. The power cord shall be used the shortest power cord as specified by the manufacturer.

For Voltage Dips/ Interruptions test:

The selection of test voltage is based on the rated power range. If the operation range is large than 20% of lower power range, both end of specified voltage shall be tested. Otherwise, the typical voltage specification is selected as test voltage.

The EUT is connected to the power mains through a coupling device that directly couples to the Voltage Dips and Interruption Generator.

The test levels shall be:

- voltage dip: 0 % residual voltage for 0,5 cycle;
- voltage dip: 0 % residual voltage for 1 cycle;
- voltage dip: 70 % residual voltage for 25 cycles (at 50 Hz);
- voltage interruption: 0 % residual voltage for 250 cycles (at 50 Hz).

Voltage phase shifting are shall occur at 0° , 45° , 90° , 135° , 180° , 225° , 270° , 315° of the voltage.

10.5. Test Specification

According to IEC 61000-4-11: 2004

10.6. Uncertainty

The uncertainty of the voltage of the waveform is $\pm 3.5 \%$

The uncertainty of the timing of the waveform is $\pm 0.1\%$.

10.7. Test Result

The measurement of the Voltage Dips and Interruption was investigated and test result was shown in section 12. The EUT complies the acceptance criterion and passes the test.

11. EMC Reduction Method During Compliance Testing

No modification was made during testing.

12. Test Result

The test results in the emission and the immunity were performed according to the requirements of measurement standard and process. Quietek Corporation is assumed full responsibility for the accuracy and completeness of these measurements. The test data of the emission is listed as below. All the tests were carried out with the EUT in normal operation, which was defined as:

EMI Mode	Mode 1: Normal Operation
EMS Mode	Mode 1: Normal Operation

12.1. Test Data of Conducted Emission

Product : Network Camera
 Test Item : Conducted Emission
 Test Site : No.1 Shielded Room
 Power Line : Line 1
 Test Mode : Mode 1: Normal Operation

Frequency MHz	Correct Factor dB	Reading Level dBuV	Measurement Level dBuV	Margin dB	Limit dBuV
LINE 1					
Quasi-Peak					
0.181	9.790	41.610	51.400	-13.714	65.114
0.236	9.790	35.810	45.600	-17.943	63.543
0.295	9.790	34.870	44.660	-17.197	61.857
0.494	9.790	36.010	45.800	-10.371	56.171
0.826	9.800	28.510	38.310	-17.690	56.000
1.572	9.810	26.230	36.040	-19.960	56.000
Average					
0.181	9.790	29.470	39.260	-15.854	55.114
0.236	9.790	22.960	32.750	-20.793	53.543
0.295	9.790	24.180	33.970	-17.887	51.857
0.494	9.790	23.960	33.750	-12.421	46.171
0.826	9.800	18.160	27.960	-18.040	46.000
1.572	9.810	18.250	28.060	-17.940	46.000

Note:

1. All Reading Levels are Quasi-Peak and average value.
2. "■" means the worst emission level.
3. Measurement Level = Reading Level + Correct Factor

Product : Network Camera
 Test Item : Conducted Emission
 Test Site : No.1 Shielded Room
 Power Line : Line 2
 Test Mode : Mode 1: Normal Operation

Frequency MHz	Correct Factor dB	Reading Level dBuV	Measurement Level dBuV	Margin dB	Limit dBuV
LINE 2					
Quasi-Peak					
0.248	9.780	30.890	40.670	-22.530	63.200
0.318	9.790	29.030	38.820	-22.380	61.200
0.451	9.790	33.830	43.620	-13.780	57.400
0.545	9.790	30.190	39.980	-16.020	56.000
0.951	9.790	29.030	38.820	-17.180	56.000
1.736	9.800	21.930	31.730	-24.270	56.000
Average					
0.248	9.780	16.790	26.570	-26.630	53.200
0.318	9.790	16.990	26.780	-24.420	51.200
0.451	9.790	17.710	27.500	-19.900	47.400
0.545	9.790	18.340	28.130	-17.870	46.000
0.951	9.790	19.160	28.950	-17.050	46.000
1.736	9.800	13.060	22.860	-23.140	46.000

Note:

1. All Reading Levels are Quasi-Peak and average value.
2. "■" means the worst emission level.
3. Measurement Level = Reading Level + Correct Factor

Product : Network Camera
 Test Item : Impedance Stabilization Network
 Test Site : No.1 Shielded Room
 Test Mode : Mode 1: Normal Operation (ISN-10Mbps)

Frequency MHz	Correct Factor dB	Reading Level dBuV	Measurement Level dBuV	Margin dB	Limit dBuV
Quasi-Peak					
0.473	9.992	55.990	65.982	-8.789	74.771
0.497	9.990	53.810	63.800	-10.286	74.086
0.877	9.980	48.230	58.210	-15.790	74.000
1.513	9.990	44.070	54.060	-19.940	74.000
7.502	9.970	48.970	58.940	-15.060	74.000
8.752	9.968	45.310	55.278	-18.722	74.000
Average					
0.473	9.992	44.410	54.402	-10.369	64.771
0.497	9.990	42.070	52.060	-12.026	64.086
0.877	9.980	38.720	48.700	-15.300	64.000
1.513	9.990	36.820	46.810	-17.190	64.000
7.502	9.970	37.520	47.490	-16.510	64.000
8.752	9.968	34.150	44.118	-19.882	64.000

Note:

1. All Reading Levels are Quasi-Peak and Average value.
2. "■" means the worst emission level.
3. Measurement Level = Reading Level + Correct Factor

Product : Network Camera
 Test Item : Impedance Stabilization Network
 Test Site : No.1 Shielded Room
 Test Mode : Mode 1: Normal Operation (ISN-100Mbps)

Frequency MHz	Correct Factor dB	Reading Level dBuV	Measurement Level dBuV	Margin dB	Limit dBuV
Quasi-Peak					
0.469	9.993	55.410	65.403	-9.483	74.886
0.494	9.990	54.270	64.260	-9.911	74.171
0.904	9.980	46.690	56.670	-17.330	74.000
1.638	9.990	45.530	55.520	-18.480	74.000
2.705	10.000	46.790	56.790	-17.210	74.000
13.357	10.150	46.130	56.280	-17.720	74.000
Average					
0.469	9.993	44.410	54.403	-10.483	64.886
0.494	9.990	42.020	52.010	-12.161	64.171
0.904	9.980	36.140	46.120	-17.880	64.000
1.638	9.990	39.170	49.160	-14.840	64.000
2.705	10.000	35.730	45.730	-18.270	64.000
13.357	10.150	43.160	53.310	-10.690	64.000

Note:

1. All Reading Levels are Quasi-Peak and Average value.
2. "■" means the worst emission level.
3. Measurement Level = Reading Level + Correct Factor

12.2. Test Data of Radiated Emission

Product : Network Camera
 Test Item : General Radiated Emission
 Test Site : No.3 OATS
 Test Mode : Mode 1: Normal Operation

Frequency MHz	Correct Factor dB	Reading Level dBuV	Measurement Level dBuV/m	Margin dB	Limit dBuV/m
Horizontal					
112.890	13.053	10.400	23.453	-6.547	30.000
180.630	10.607	11.200	21.807	-8.193	30.000
225.780	11.334	13.600	24.934	-5.066	30.000
305.440	15.915	8.900	24.815	-12.185	37.000
570.490	22.318	6.200	28.518	-8.482	37.000
775.040	24.405	5.700	30.105	-6.895	37.000
112.890	13.053	10.400	23.453	-6.547	30.000
Vertical					
135.470	13.115	12.900	26.015	-3.985	30.000
142.695	12.722	13.900	26.622	-3.378	30.000
158.050	11.560	15.200	26.760	-3.240	30.000
203.200	10.928	14.800	25.728	-4.272	30.000
305.440	15.915	10.900	26.815	-10.185	37.000
725.040	24.202	4.000	28.202	-8.798	37.000
972.130	26.475	2.600	29.075	-7.925	37.000

Note:

1. All Readings below 1GHz are Quasi-Peak, above are performed with peak and/or average measurements as necessary.
2. "■" means the worst emission level.
3. Measurement Level = Reading Level + Correct Factor

Product : Network Camera
 Test Item : General Radiated Emission
 Test Site : No.3 OATS
 Test Mode : Mode 1: Normal Operation

Frequency (MHz)	Measure Level (dBuV/m)	Reading Level (dBuV)	Over Limit (dB)	Limit (dBuV/m)	Factor (dB)
Horizontal					
Peak Detector					
1350.000	52.355	59.640	-17.645	70.000	-7.285
1880.000	45.432	51.800	-24.568	70.000	-6.368
Average Detector					
1350.000	33.265	40.550	-16.735	50.000	-7.285
Peak Detector					
1350.000	55.135	62.420	-14.865	70.000	-7.285
1880.000	45.142	51.510	-24.858	70.000	-6.368
Average Detector					
1350.000	32.595	39.880	-17.405	50.000	-7.285

Note:

1. All Readings below 1GHz are Quasi-Peak, above are performed with peak and/or average measurements as necessary.
2. "■" means the worst emission level.
3. Measurement Level = Reading Level + Correct Factor

12.3. Test Data of Power Harmonics, Voltage Flucturation and Flicker

Product : Network Camera
 Test Item : Power Harmonics
 Classification : Class A
 Test Mode : Mode 1: Normal Operation

Test Result: Pass Source qualification: Normal

Current & voltage waveforms

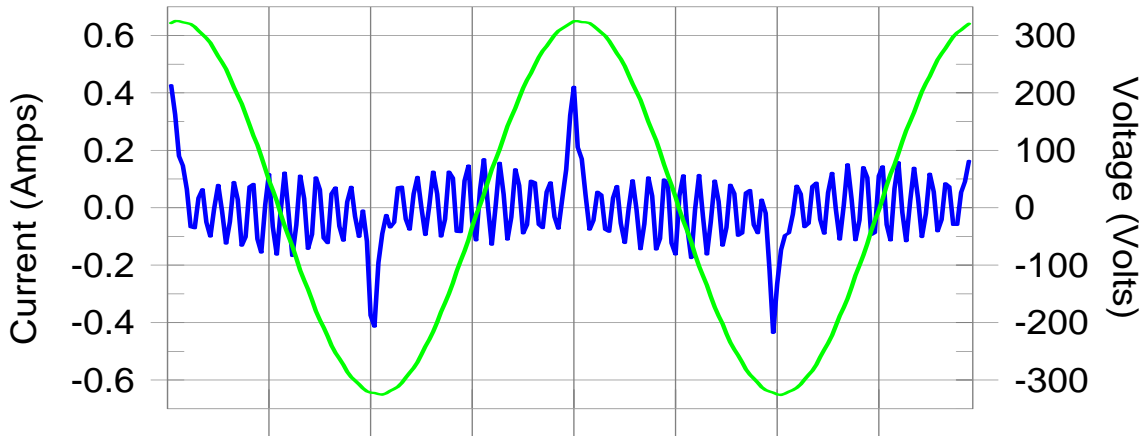

Harmonics and Class A limit line

European Limits

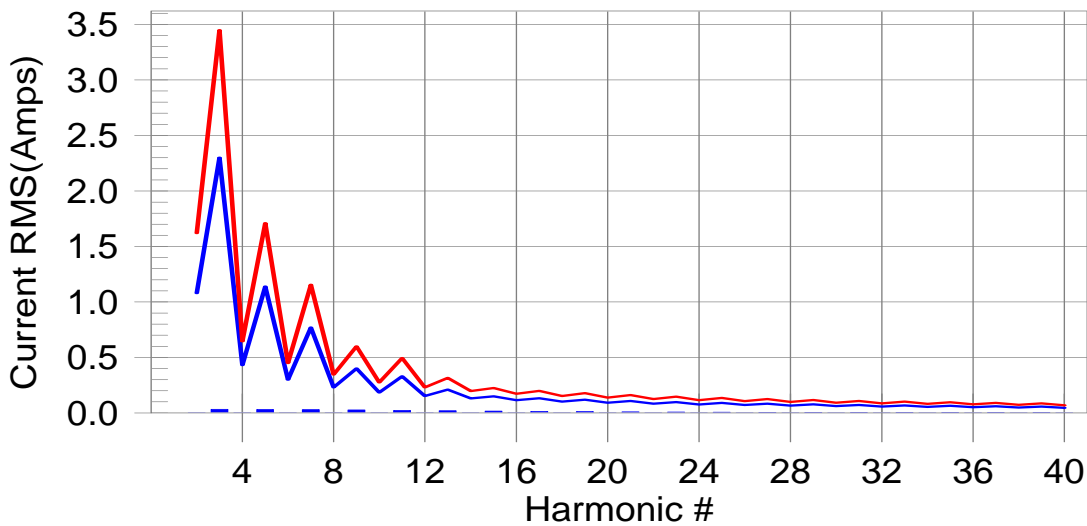

Test result: Pass Worst harmonic was #15 with 9.53% of the limit.

Test Result: Pass Source qualification: Normal
 THC(A): 0.06 I-THD(%): 180.34 POHC(A): 0.010 POHC Limit(A): 0.251
 Highest parameter values during test:
 V_RMS (Volts): 229.63 Frequency(Hz): 50.00
 I_Peak (Amps): 0.484 I_RMS (Amps): 0.118
 I_Fund (Amps): 0.039 Crest Factor: 4.199
 Power (Watts): 7.8 Power Factor: 0.290

Harm#	Harms(avg)	100%Limit	%of Limit	Harms(max)	150%Limit	%of Limit	Status
2	0.001	1.080	0.0	0.001	1.620	0.05	Pass
3	0.027	2.300	1.2	0.033	3.450	0.95	Pass
4	0.001	0.430	0.1	0.001	0.645	0.12	Pass
5	0.026	1.140	2.3	0.031	1.710	1.83	Pass
6	0.001	0.300	0.2	0.001	0.450	0.20	Pass
7	0.024	0.770	3.1	0.029	1.155	2.52	Pass
8	0.001	0.230	0.3	0.001	0.345	0.25	Pass
9	0.022	0.400	5.5	0.026	0.600	4.40	Pass
10	0.001	0.184	0.4	0.001	0.276	0.33	Pass
11	0.020	0.330	5.9	0.023	0.495	4.74	Pass
12	0.001	0.153	0.5	0.001	0.230	0.42	Pass
13	0.017	0.210	8.0	0.020	0.315	6.45	Pass
14	0.001	0.131	0.6	0.001	0.197	0.48	Pass
15	0.014	0.150	9.5	0.017	0.225	7.64	Pass
16	0.001	0.115	0.7	0.001	0.173	0.55	Pass
17	0.012	0.132	8.9	0.014	0.199	7.17	Pass
18	0.001	0.102	0.8	0.001	0.153	0.64	Pass
19	0.010	0.118	8.1	0.012	0.178	6.59	Pass
20	0.001	0.092	0.8	0.001	0.138	0.63	Pass
21	0.008	0.107	7.1	0.010	0.161	5.95	Pass
22	0.001	0.084	0.8	0.001	0.125	0.67	Pass
23	0.006	0.098	6.3	0.008	0.147	5.43	Pass
24	0.001	0.077	0.8	0.001	0.115	0.66	Pass
25	0.005	0.090	5.6	0.007	0.135	5.04	Pass
26	0.001	0.071	0.8	0.001	0.106	0.67	Pass
27	0.004	0.083	5.1	0.006	0.125	4.79	Pass
28	0.001	0.066	0.8	0.001	0.099	0.67	Pass
29	0.004	0.078	4.8	0.005	0.116	4.65	Pass
30	0.001	0.061	0.9	0.001	0.092	0.74	Pass
31	0.003	0.073	4.6	0.005	0.109	4.47	Pass
32	0.000	0.058	0.8	0.001	0.086	0.68	Pass
33	0.003	0.068	4.4	0.004	0.102	4.31	Pass
34	0.000	0.054	0.8	0.001	0.081	0.70	Pass
35	0.003	0.064	4.2	0.004	0.096	4.10	Pass
36	0.000	0.051	0.8	0.001	0.077	0.67	Pass
37	0.002	0.061	4.0	0.004	0.091	3.87	Pass
38	0.000	0.048	0.8	0.001	0.073	0.70	Pass
39	0.002	0.058	3.7	0.003	0.087	3.59	Pass
40	0.000	0.046	0.9	0.000	0.069	0.72	Pass

- Dynamic limits were applied for this test. The highest harmonics values in the above table may not occur at the same window as the maximum harmonics/limit ratio.
- According to EN61000-3-2 paragraph 7 the note 1 and 2 are valid for all applications having an active input power >75W. Others the result should be pass.

Product : Network Camera
 Test Item : Voltage Fluctuations and Flicker
 Test Mode : Mode 1: Normal Operation

Test Result: Pass

Status: Test Completed

Pst_i and limit line

European Limits

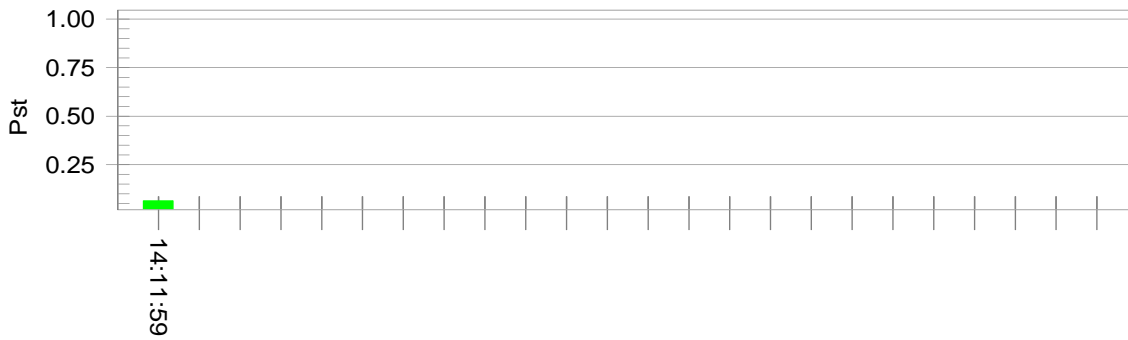

Plt and limit line

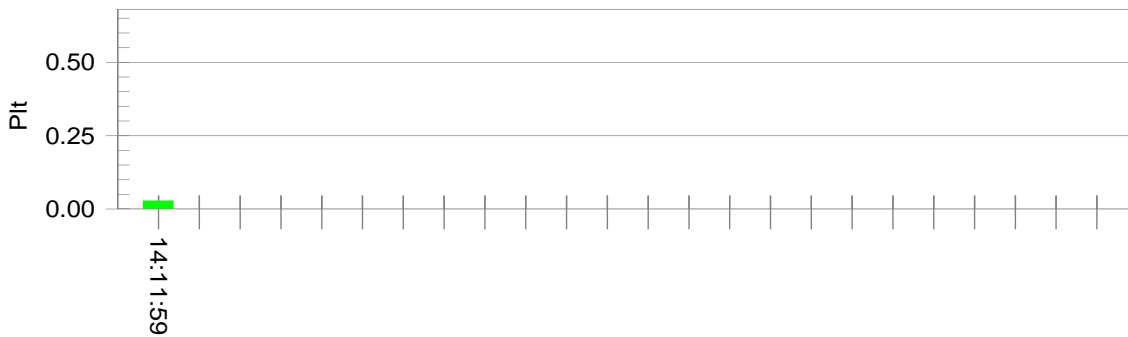

Parameter values recorded during the test:

Vrms at the end of test (Volt):	229.50		
Highest dt (%):	0.00	Test limit (%):	3.30 Pass
Time(mS) > dt:	0.0	Test limit (mS):	500.0 Pass
Highest dc (%):	0.00	Test limit (%):	3.30 Pass
Highest dmax (%):	0.00	Test limit (%):	4.00 Pass
Highest Pst (10 min. period):	0.064	Test limit:	1.000 Pass
Highest Plt (2 hr. period):	0.028	Test limit:	0.650 Pass

12.4. Test Data of Electrostatic Discharge

Product : Network Camera
 Test Item : Electrostatic Discharge
 Test Site : No.3 Shielded Room
 Test Mode : Mode 1: Normal Operation

Item	Amount of Discharge	Voltage	Required Criteria	Complied To Criteria (A, B, C)	Results
Air Discharge	10	+2kV, +4kV, +8kV	B	B	Pass
	10	-2kV, -4kV, -8kV	B	B	Pass
Contact Discharge	25	+2kV, +4kV	B	A	Pass
	25	-2kV, -4kV	B	A	Pass
Indirect Discharge (HCP)	25	+2kV, +4kV	B	A	Pass
	25	-2kV, -4kV	B	A	Pass
Indirect Discharge (VCP Front)	25	+2kV, +4kV	B	A	Pass
	25	-2kV, -4kV	B	A	Pass
Indirect Discharge (VCP Left)	25	+2kV, +4kV	B	A	Pass
	25	-2kV, -4kV	B	A	Pass
Indirect Discharge (VCP Back)	25	+2kV, +4kV	B	A	Pass
	25	-2kV, -4kV	B	A	Pass
Indirect Discharge (VCP Right)	25	+2kV, +4kV	B	A	Pass
	25	-2kV, -4kV	B	A	Pass

Note:

The testing performed is from lowest level up to the highest level as required by standard, but only highest level is shown on the report.

NR: No Requirement

- Meet criteria A: Operate as intended during and after the test
- Meet criteria B: Operate as intended after the test
- Meet criteria C: Loss/Error of function
- Additional Information
 - EUT stopped operation and could / could not be reset by operator at ____ kV.
 - No false alarms or other malfunctions were observed during or after the test.

12.5. Test Data of Radiated Susceptibility

Product : Network Camera
 Test Item : Radiated Susceptibility
 Test Site : No.2 EMC fully Chamber
 Test Mode : Mode 1: Normal Operation

Frequency (MHz)	Position (Angle)	Polarity (H or V)	Field Strength (V/m)	Required Criteria	Complied To Criteria (A, B, C)	Results
80-1000	Front	H	3	A	A	Pass
80-1000	Front	V	3	A	A	Pass
80-1000	Back	H	3	A	A	Pass
80-1000	Back	V	3	A	A	Pass
80-1000	Left	H	3	A	A	Pass
80-1000	Left	V	3	A	A	Pass
80-1000	Right	H	3	A	A	Pass
80-1000	Right	V	3	A	A	Pass
80-1000	Top	H	3	A	A	Pass
80-1000	Top	V	3	A	A	Pass
80-1000	Down	H	3	A	A	Pass
80-1000	Down	V	3	A	A	Pass
1400-2700	Front	H	3	A	A	Pass
1400-2700	Front	V	3	A	A	Pass
1400-2700	Back	H	3	A	A	Pass
1400-2700	Back	V	3	A	A	Pass
1400-2700	Left	H	3	A	A	Pass
1400-2700	Left	V	3	A	A	Pass
1400-2700	Right	H	3	A	A	Pass
1400-2700	Right	V	3	A	A	Pass
1400-2700	Top	H	3	A	A	Pass
1400-2700	Top	V	3	A	A	Pass
1400-2700	Down	H	3	A	A	Pass
1400-2700	Down	V	3	A	A	Pass

Note:

The exclusion band for the transmitter and/or receiver part of the 2.45GHz RLAM equipment under test shall extend from 2280MHz to 2607.675MHz.

- Meet criteria A: Operate as intended during and after the test
- Meet criteria B: Operate as intended after the test
- Meet criteria C: Loss/Error of function
- Additional Information
 - There was no observable degradation in performance.
 - EUT stopped operation and could / could not be reset by operator at _____ V/m at frequency _____ MHz.
- No false alarms or other malfunctions were observed during or after the test.

12.6. Test Data of Electrical Fast Transient

Product : Network Camera
 Test Item : Electrical Fast Transient
 Test Site : No.3 Shielded Room
 Test Mode : Mode 1: Normal Operation

Inject Line	Polarity	Voltage (kV)	Inject Time (Second)	Inject Method	Required Criteria	Complied to Criteria	Result
L-N	±	1kV	60	Direct	B	B	PASS
LAN	±	0.5kV	60	Clamp	B	B	PASS

Note:

The testing performed is from lowest level up to the highest level as required by standard, but only highest level is shown on the report.

- Meet criteria A : Operate as intended during and after the test
- Meet criteria B : Operate as intended after the test
- Meet criteria C : Loss/Error of function
- Additional Information
 - EUT stopped operation and could / could not be reset by operator at _____ kV of Line _____.
 - No false alarms or other malfunctions were observed during or after the test.

12.7. Test Data of Surge

Product : Network Camera
 Test Item : Surge
 Test Site : No. 3 Shielded Room
 Test Mode : Mode 1: Normal Operation

Inject Line	Polarity	Angle	Voltage (kV)	Time Interval (Second)	Inject Method	Required Criteria	Complied to Criteria	Result
L-N	±	0	1	60	Direct	B	A	Pass
L-N	±	90	1	60	Direct	B	A	Pass
L-N	±	180	1	60	Direct	B	A	Pass
L-N	±	270	1	60	Direct	B	A	Pass

Note:

The testing performed is from lowest level up to the highest level as required by standard, but only highest level is shown on the report.

- Meet criteria A : Operate as intended during and after the test
- Meet criteria B : Operate as intended after the test
- Meet criteria C : Loss/Error of function
- Additional Information
 - EUT stopped operation and could / could not be reset by operator at _____ kV of Line _____.
 - No false alarms or other malfunctions were observed during or after the test.

12.8. Test Data of Conducted Susceptibility

Product : Network Camera
 Test Item : Conducted Susceptibility
 Test Site : No. 6 Shielded Room
 Test Mode : Mode 1: Normal Operation

Frequency Range (MHz)	Voltage Applied (dBuV(V))	Inject Method	Tested Port of EUT	Required Criteria	Performance Criteria Complied To	Result
0.15~80	130 (3V)	CDN	AC IN	A	A	PASS
0.15~80	130 (3V)	CDN	LAN	A	A	PASS

Note:

The testing performed is from lowest level up to the highest level as required by standard, but only highest level is shown on the report.

- Meet criteria A: Operate as intended during and after the test
- Meet criteria B: Operate as intended after the test
- Meet criteria C: Loss/Error of function
- Additional Information
 - EUT stopped operation and could / could not be reset by operator at _____ kV of Line _____.
 - No false alarms or other malfunctions were observed during or after the test. The acceptance criteria were met, and the EUT passed the test.

12.9. Test Data of Voltage Dips and Interruption

Product : Network Camera
 Test Item : Voltage Dips and Interruption
 Test Site : No.3 Shielded Room
 Test Mode : Mode 1: Normal Operation

Voltage Dips and Interruption Reduction(%)	Angle	Test Duration (Periods)	Required Performance Criteria	Performance Criteria Complied To	Test Result
100%	0	0.5	B	A	PASS
100%	45	0.5	B	A	PASS
100%	90	0.5	B	A	PASS
100%	135	0.5	B	A	PASS
100%	180	0.5	B	A	PASS
100%	225	0.5	B	A	PASS
100%	270	0.5	B	A	PASS
100%	315	0.5	B	A	PASS
100%	0	1	B	A	PASS
100%	45	1	B	A	PASS
100%	90	1	B	A	PASS
100%	135	1	B	A	PASS
100%	180	1	B	A	PASS
100%	225	1	B	A	PASS
100%	270	1	B	A	PASS
100%	315	1	B	A	PASS
30%	0	25	B	A	PASS
30%	45	25	B	A	PASS
30%	90	25	B	A	PASS
30%	135	25	B	A	PASS
30%	180	25	B	A	PASS
30%	225	25	B	A	PASS
30%	270	25	B	A	PASS
30%	315	25	B	A	PASS
100%	0	250	C	B	PASS
100%	45	250	C	B	PASS
100%	90	250	C	B	PASS
100%	135	250	C	B	PASS
100%	180	250	C	B	PASS
100%	225	250	C	B	PASS
100%	270	250	C	B	PASS
100%	315	250	C	B	PASS

- Meet criteria A: Operate as intended during and after the test
 Meet criteria B: Operate as intended after the test
 Meet criteria C: Loss/Error of function
 Additional Information
 The nominal voltage of EUT is 230V.
 EUT stopped operation and could / could not be reset by operator at _____ kV of Line _____.
 No false alarms or other malfunctions were observed during or after the test. The acceptance criteria were met, and the EUT passed the test.

Attachment 1: EUT Test Photographs

Attachment 1: EUT Test Setup Photographs

Front View of Conducted Test



Back View of Conducted Test



Front View of ISN Test



Back View of ISN Test



Front View of Radiated Test



Back View of Radiated Test



Front View of Radiated Test (Horn)



Power Harmonics Test Setup



ESD Test Setup



Radiated Susceptibility Test Setup

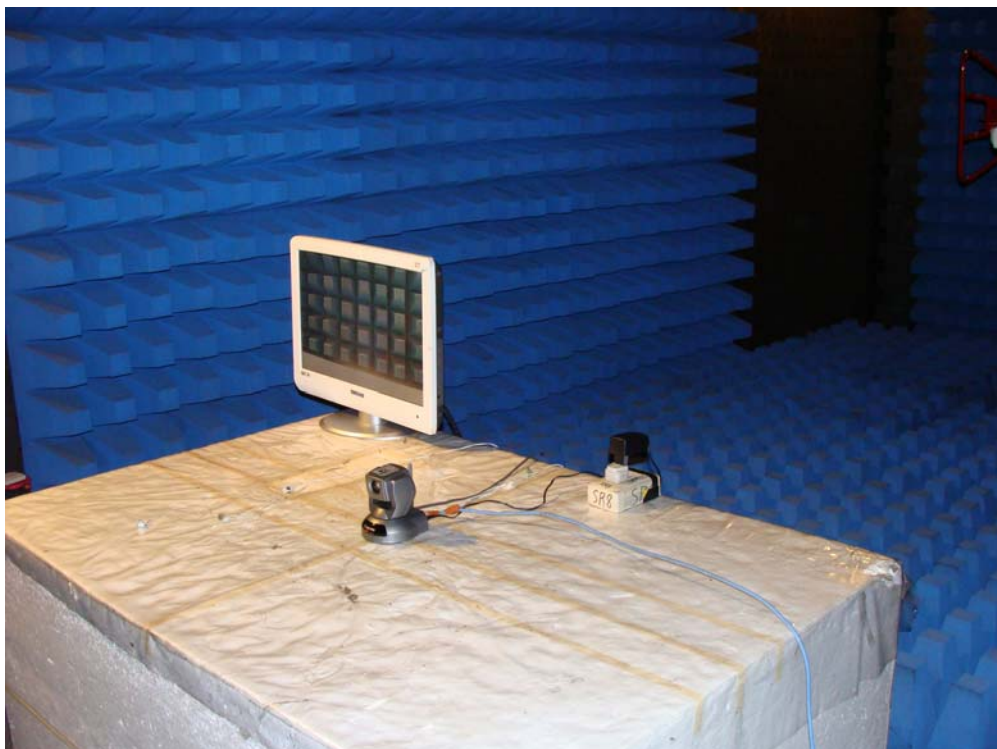

EFT/B Test Setup



EFT/B Test Setup -Clamp



SURGE Test Setup



Conducted Susceptibility Test Setup



Conducted Susceptibility Test Setup -CDN



Voltage Dips Test Setup



Attachment 2: EUT Detailed Photographs

Attachment 2 : EUT Detailed Photographs

(1) EUT Photo



(2) EUT Photo



(3) EUT Photo



(4) EUT Photo



(5) EUT Photo



(6) EUT Photo



(7) EUT Photo



(8) EUT Photo

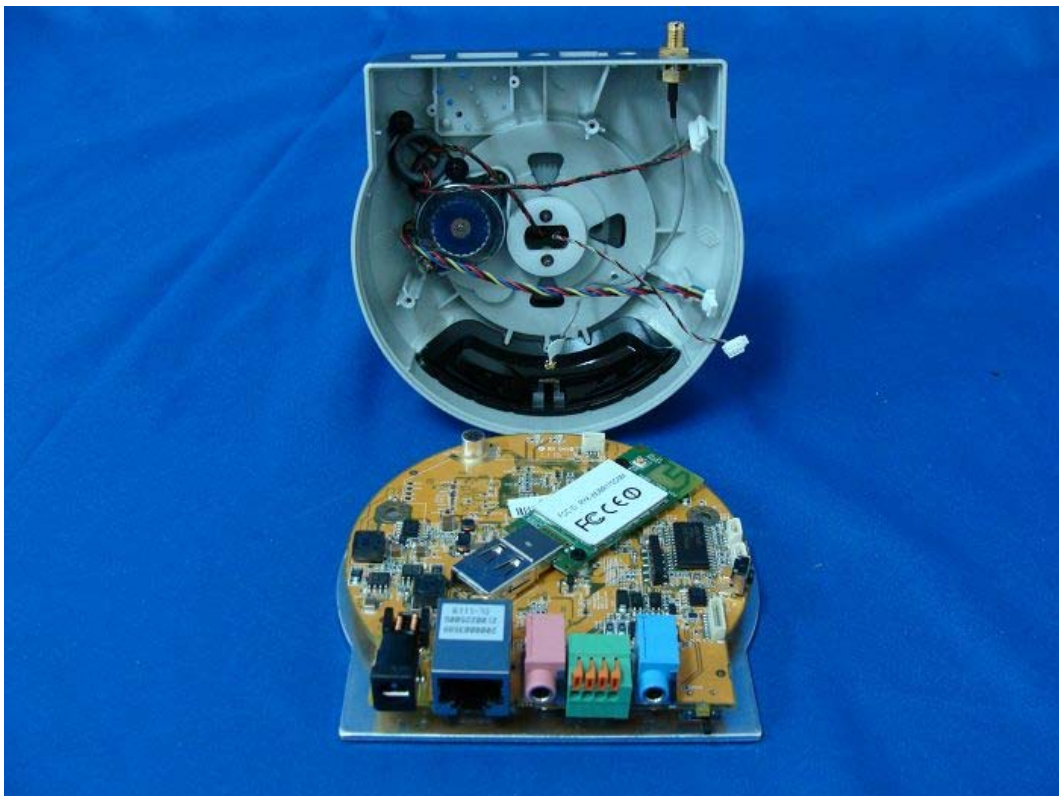

(9) EUT Photo



(10) EUT Photo

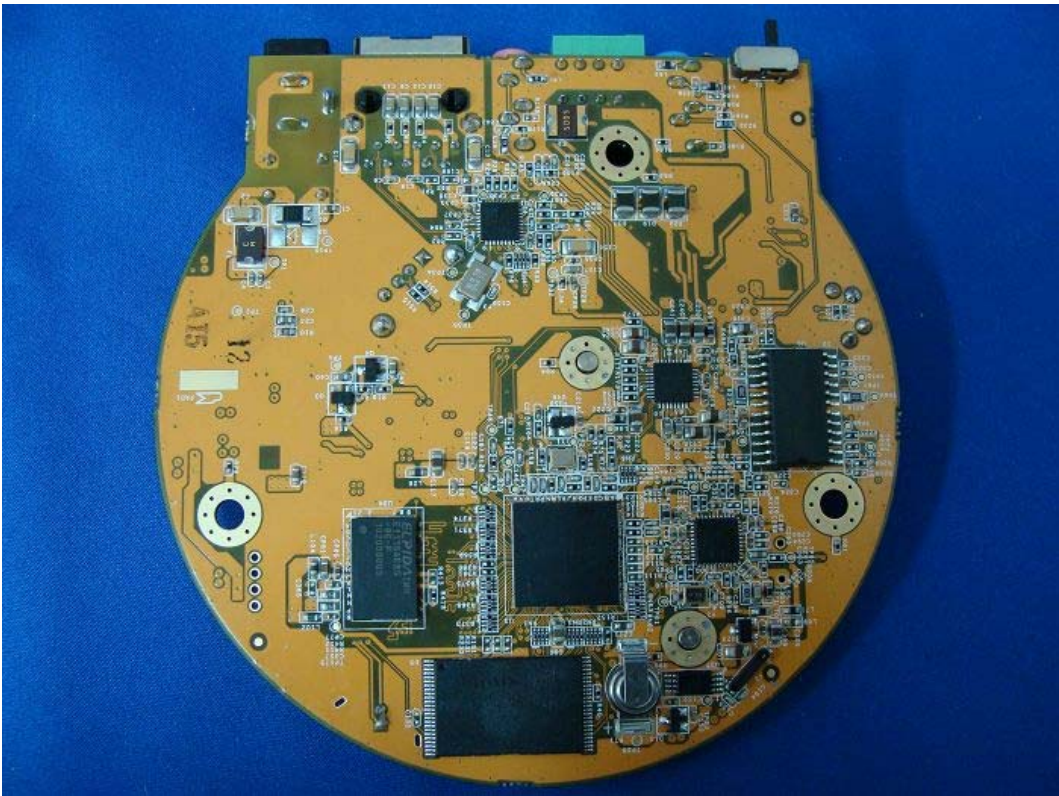

(11) EUT Photo

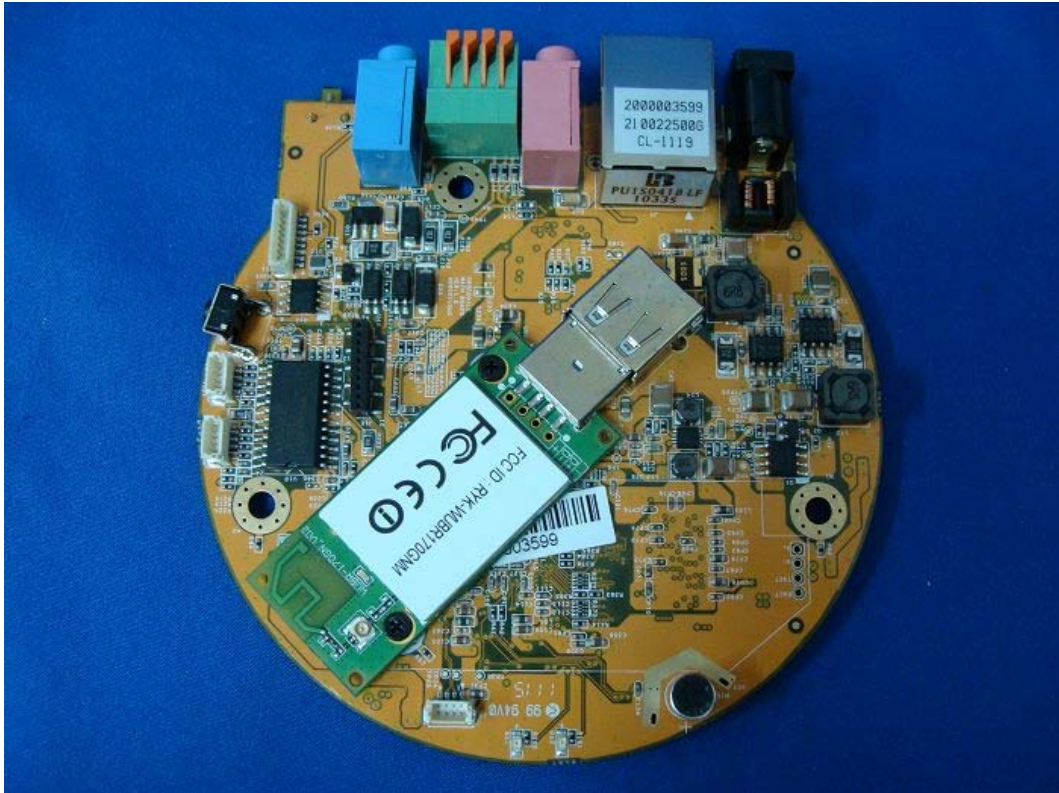

(12) EUT Photo

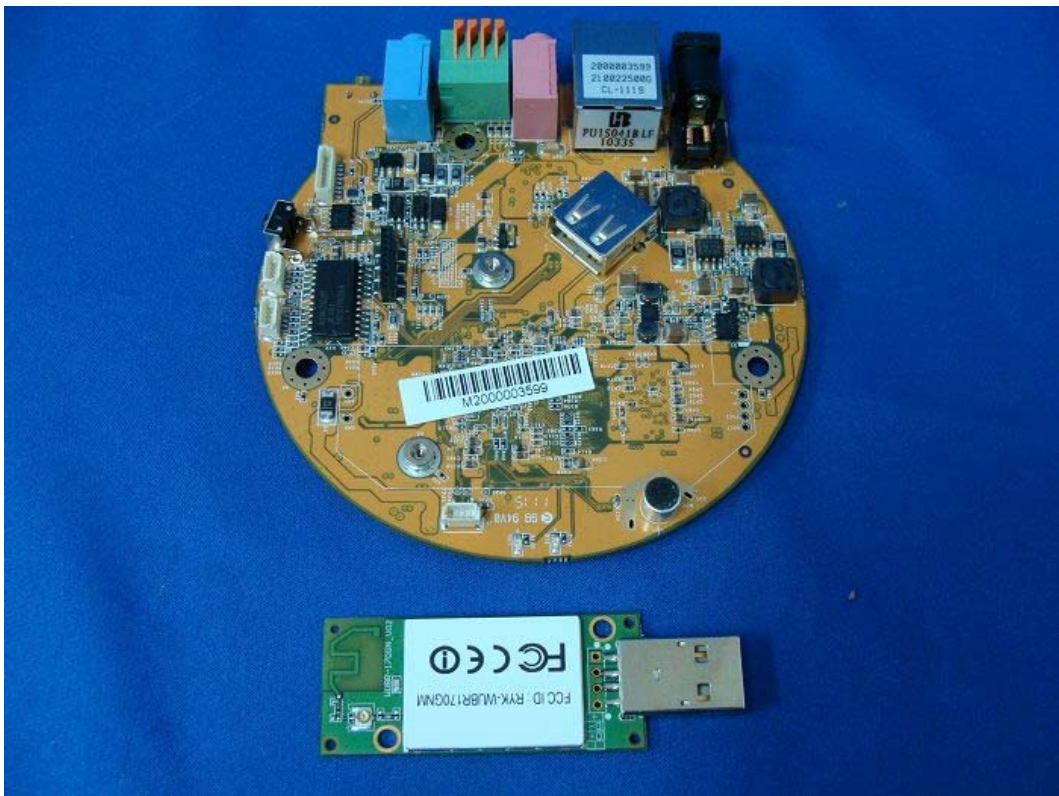

(13) EUT Photo



(14) EUT Photo



(15) EUT Photo

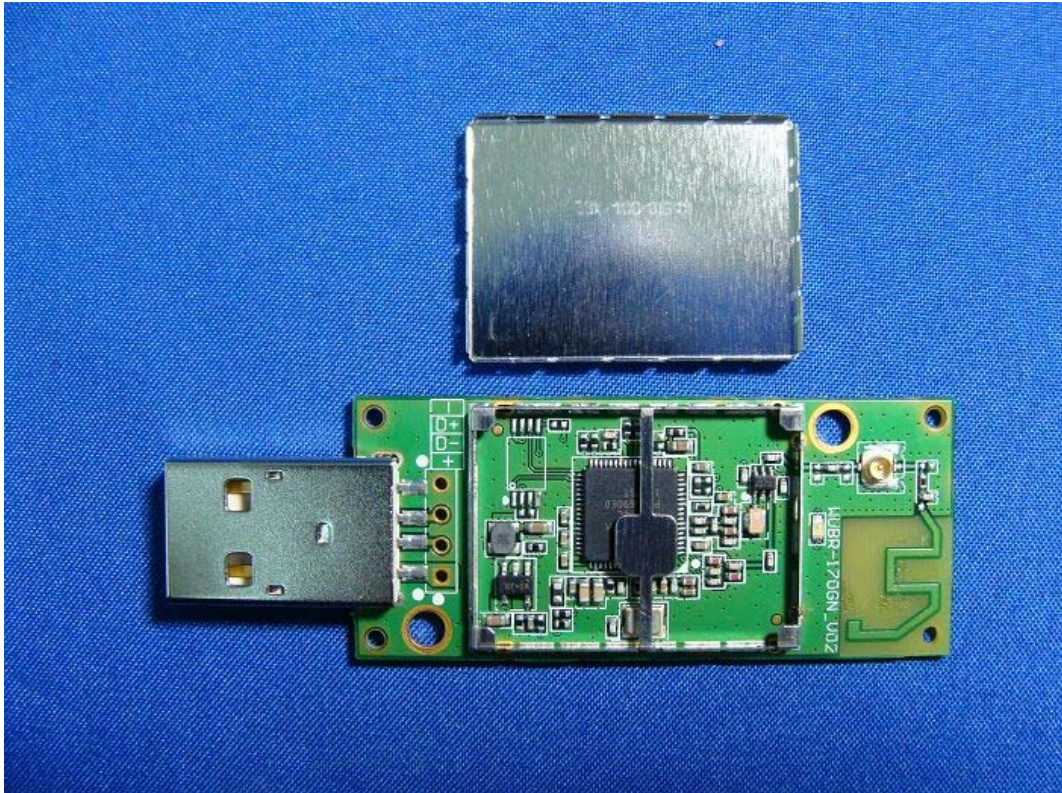

(16) EUT Photo

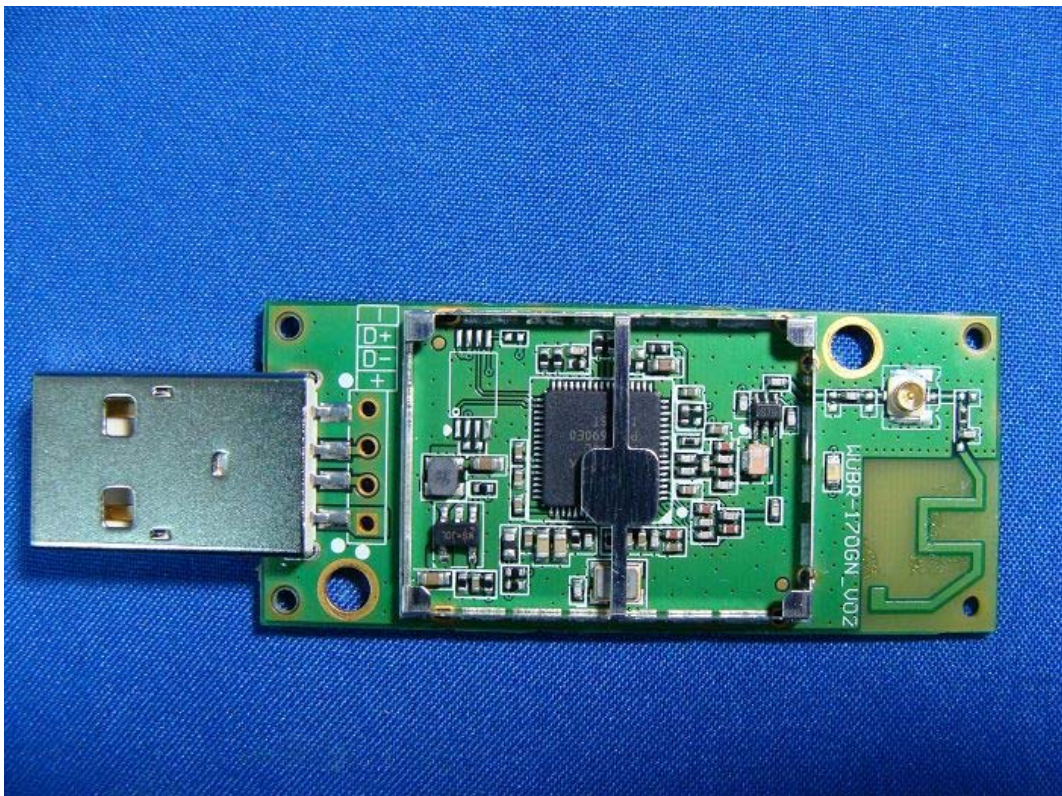

(17) EUT Photo

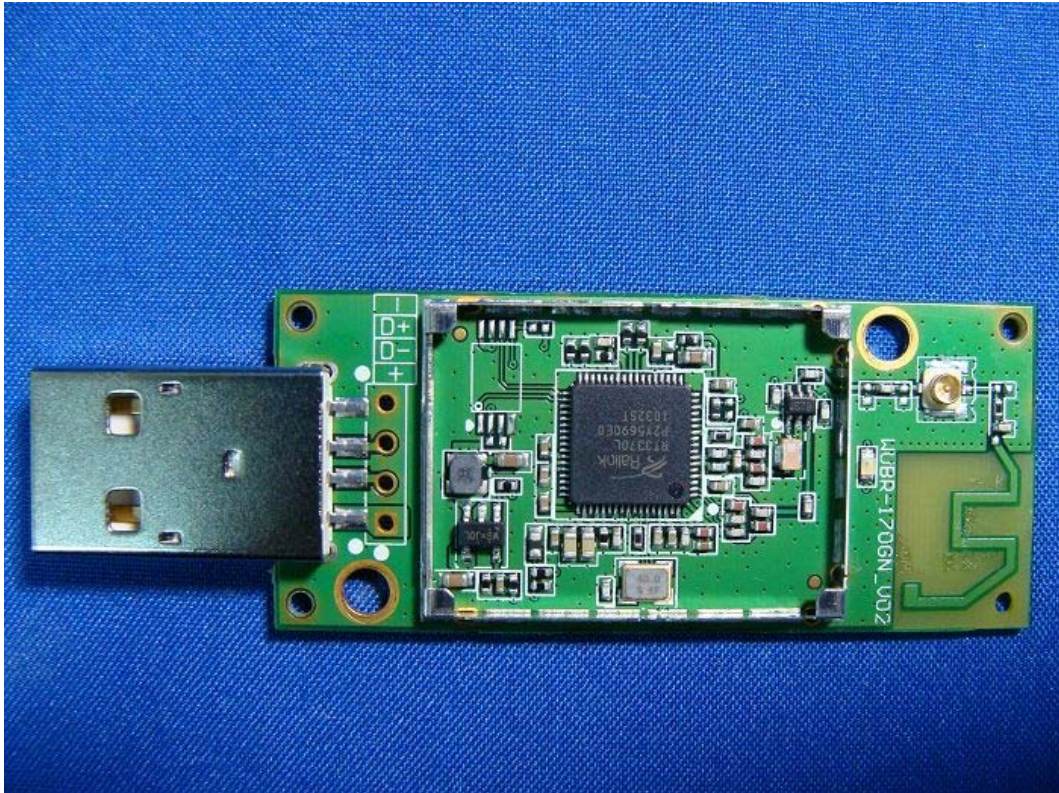

(18) EUT Photo



(19) EUT Photo

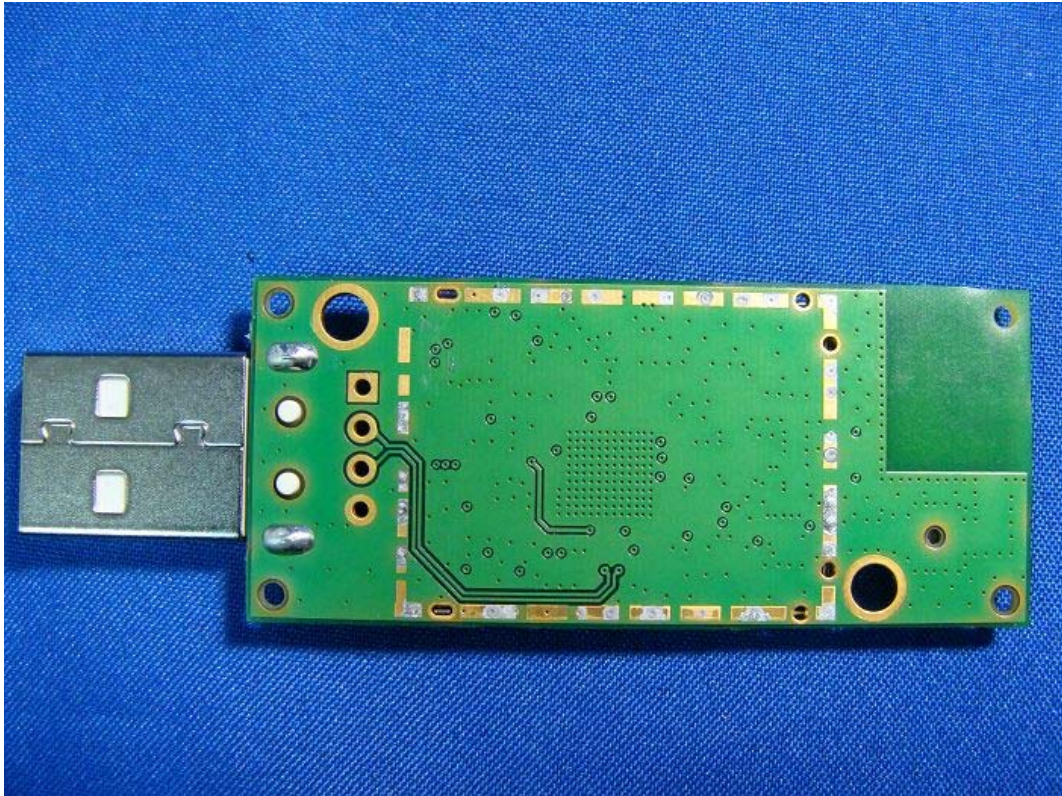

(20) EUT Photo



(21) EUT Photo



(22) EUT Photo



(23) EUT Photo



(24) EUT Photo

