



# CE EMC TEST REPORT

**REPORT NO.:** CE120112D07

**MODEL NO.:** FD8135H

**RECEIVED:** Jan. 12, 2012

**TESTED:** Jan. 13 ~ Feb. 16, 2012

**ISSUED:** Feb. 29, 2012

**APPLICANT:** VIVOTEK INC.

**ADDRESS:** 6F, No.192, Lien-Cheng Rd., Chung-Ho , New Taipei City, 235, Taiwan, R.O.C.

**ISSUED BY:** Bureau Veritas Consumer Products Services (H.K.) Ltd., Taoyuan Branch

**LAB LOCATION:** No. 47, 14th Ling, Chia Pau Vil., Lin Kou Dist., New Taipei City 244, Taiwan (R.O.C.)

This test report consists of 90 pages in total. It may be duplicated completely for legal use with the approval of the applicant. It should not be reproduced except in full, without the written approval of our laboratory. The client should not use it to claim product certification, approval, or endorsement by TAF or any government agency. The test results in the report only apply to the tested sample. The test results in this report are traceable to the national or international standards.





# Table of Contents

|  |    |
|--|----|
| RELEASE CONTROL RECORD.....  | 5  |
| 1 CERTIFICATION.....   | 6  |
| 2 SUMMARY OF TEST RESULTS.....   | 7  |
| 2.1 MEASUREMENT UNCERTAINTY .....  | 8  |
| 3 GENERAL INFORMATION .....  | 9  |
| 3.1 GENERAL DESCRIPTION OF EUT.....  | 9  |
| 3.2 DESCRIPTION OF TEST MODES.....   | 10 |
| 3.3 GENERAL DESCRIPTION OF APPLIED STANDARDS .....                                   | 11 |
| 3.4 DESCRIPTION OF SUPPORT UNITS.....  | 12 |
| 3.4.1 FOR EMISSION TEST .....  | 12 |
| 3.4.2 FOR IMMUNITY TEST .....  | 16 |
| 4 EMISSION TEST.....   | 18 |
| 4.1 CONDUCTED EMISSION MEASUREMENT .....   | 18 |
| 4.1.1 LIMITS OF CONDUCTED EMISSION MEASUREMENT.....                                  | 18 |
| 4.1.2 TEST INSTRUMENTS .....   | 19 |
| 4.1.3 TEST PROCEDURE .....   | 19 |
| 4.1.4 DEVIATION FROM TEST STANDARD .....   | 20 |
| 4.1.5 TEST SETUP .....   | 20 |
| 4.1.6 EUT OPERATING CONDITIONS.....  | 20 |
| 4.1.7 TEST RESULTS (1) .....   | 21 |
| 4.1.8 TEST RESULTS (2) .....   | 23 |
| 4.2 CONDUCTED EMISSION MEASUREMENT AT TELECOMMUNICATION<br>PORTS.....                | 25 |
| 4.2.1 LIMIT OF CONDUCTED COMMON MODE DISTURBANCE AT<br>TELECOMMUNICATION PORTS ..... | 25 |
| 4.2.2 TEST INSTRUMENTS .....   | 26 |
| 4.2.3 TEST PROCEDURE .....   | 27 |
| 4.2.4 DEVIATION FROM TEST STANDARD .....   | 27 |
| 4.2.5 TEST SETUP .....   | 28 |
| 4.2.6 EUT OPERATING CONDITIONS.....  | 30 |
| 4.2.7 TEST RESULTS (1) .....   | 31 |
| 4.2.8 TEST RESULTS (2) .....   | 33 |
| 4.3 RADIATED EMISSION MEASUREMENT .....  | 35 |
| 4.3.1 LIMITS OF RADIATED EMISSION MEASUREMENT.....                                   | 35 |
| 4.3.2 TEST INSTRUMENTS .....   | 36 |
| 4.3.3 TEST PROCEDURE .....   | 37 |
| 4.3.4 DEVIATION FROM TEST STANDARD .....   | 38 |
| 4.3.5 TEST SETUP .....   | 39 |
| 4.3.6 EUT OPERATING CONDITIONS.....  | 40 |
| 4.3.7 TEST RESULTS (1) .....   | 41 |
| 4.3.8 TEST RESULTS (2) .....   | 45 |
| 5 IMMUNITY TEST .....  | 49 |
| 5.1 GENERAL DESCRIPTION.....   | 49 |



|       |  |    |
|-------|--|----|
| 5.2   | GENERAL PERFORMANCE CRITERIA DESCRIPTION .....                           | 50 |
| 5.3   | EUT OPERATING CONDITION .....  | 51 |
| 5.4   | ELECTROSTATIC DISCHARGE IMMUNITY TEST (ESD).....                         | 52 |
| 5.4.1 | TEST SPECIFICATION .....   | 52 |
| 5.4.2 | TEST INSTRUMENTS .....   | 52 |
| 5.4.3 | TEST PROCEDURE .....   | 52 |
| 5.4.4 | DEVIATION FROM TEST STANDARD .....                                       | 53 |
| 5.4.5 | TEST SETUP .....   | 54 |
| 5.4.6 | TEST RESULTS.....  | 55 |
| 5.5   | RADIATED, RADIO-FREQUENCY, ELECTROMAGNETIC FIELD IMMUNITY TEST (RS)..... | 56 |
| 5.5.1 | TEST SPECIFICATION .....   | 56 |
| 5.5.2 | TEST INSTRUMENTS .....   | 57 |
| 5.5.3 | TEST PROCEDURE .....   | 58 |
| 5.5.4 | DEVIATION FROM TEST STANDARD .....                                       | 58 |
| 5.5.5 | TEST SETUP .....   | 59 |
| 5.5.6 | TEST RESULTS.....  | 60 |
| 5.6   | ELECTRICAL FAST TRANSIENT/BURST IMMUNITY TEST (EFT) .....                | 61 |
| 5.6.1 | TEST SPECIFICATION .....   | 61 |
| 5.6.2 | TEST INSTRUMENTS .....   | 61 |
| 5.6.3 | TEST PROCEDURE .....   | 61 |
| 5.6.4 | DEVIATION FROM TEST STANDARD .....                                       | 61 |
| 5.6.5 | TEST SETUP .....   | 62 |
| 5.6.6 | TEST RESULTS (1) .....   | 63 |
| 5.7   | SURGE IMMUNITY TEST .....  | 64 |
| 5.7.1 | TEST SPECIFICATION .....   | 64 |
| 5.7.2 | TEST INSTRUMENTS .....   | 64 |
| 5.7.3 | TEST PROCEDURE .....   | 65 |
| 5.7.4 | DEVIATION FROM TEST STANDARD .....                                       | 65 |
| 5.7.5 | TEST SETUP .....   | 65 |
| 5.7.6 | TEST RESULTS.....  | 66 |
| 5.8   | IMMUNITY TO CONDUCTED DISTURBANCES INDUCED BY RF FIELDS (CS).....        | 67 |
| 5.8.1 | TEST SPECIFICATION .....   | 67 |
| 5.8.2 | TEST INSTRUMENTS .....   | 68 |
| 5.8.3 | TEST PROCEDURE .....   | 69 |
| 5.8.4 | DEVIATION FROM TEST STANDARD .....                                       | 69 |
| 5.8.5 | TEST SETUP .....   | 70 |
| 5.8.6 | TEST RESULTS.....  | 71 |
| 5.9   | POWER FREQUENCY MAGNETIC FIELD IMMUNITY TEST .....                       | 72 |
| 5.9.1 | TEST SPECIFICATION .....   | 72 |
| 5.9.2 | TEST INSTRUMENTS .....   | 72 |
| 5.9.3 | TEST PROCEDURE .....   | 72 |
| 5.9.4 | DEVIATION FROM TEST STANDARD .....                                       | 72 |
| 5.9.5 | TEST SETUP .....   | 73 |
| 5.9.6 | TEST RESULTS.....  | 74 |



|   |   |    |
|---|---|----|
| 6 | PHOTOGRAPHS OF THE TEST CONFIGURATION.....              | 75 |
| 7 | APPENDIX - INFORMATION ON THE TESTING LABORATORIES..... | 90 |



## RELEASE CONTROL RECORD

| ISSUE NO.   | REASON FOR CHANGE | DATE ISSUED   |
|-------------|-------------------|---------------|
| CE120112D07 | Original release  | Feb. 29, 2012 |



# 1 CERTIFICATION

**PRODUCT:** Indoor Dome Network Camera

**BRADN NAME:** VIVOTEK

**MODEL NO.:** FD8135H

**APPLICANT:** VIVOTEK INC.

**TEST ITEM:** ENGINEERING SAMPLE

**TESTED:** Jan. 13 ~ Feb. 16, 2012

**STANDARDS: EN 55022:2010, Class B**

**EN 55024:2010**

IEC 61000-4-2:2008 ED.2.0

IEC 61000-4-3:2010 ED.3.2

IEC 61000-4-4:2011 ED.2.1

IEC 61000-4-5:2005 ED.2.0

IEC 61000-4-6:2008 ED.3.0

IEC 61000-4-8:2009 ED.2.0

IEC 61000-4-11:2004 ED.2.0 (Not Applicable)

The above equipment has been tested by **Bureau Veritas Consumer Products Services (H.K.) Ltd., Taoyuan Branch**, and found compliance with the requirement of the above standards. The test record, data evaluation & Equipment Under Test (EUT) configurations represented herein are true and accurate accounts of the measurements of the sample's EMC characteristics under the conditions specified in this report.

PREPARED BY : Celia Chen , DATE: Feb. 29. 2012  
( Celia Chen / Senior Specialist )

APPROVED BY : Henry Lai , DATE: Feb. 29. 2012  
( Henry Lai / Director )

## 2 SUMMARY OF TEST RESULTS

The EUT has been tested according to the following specifications:

| EMISSION                  |                                  |        |  |
|---------------------------|----------------------------------|--------|--|
| Standard                  | Test Type                        | Result | Remarks  |
| EN 55022:2010,<br>Class B | Conducted Test                   | PASS   | Meets Class B Limit<br>Minimum passing margin is<br>-6.70 dB at 0.373 MHz  |
|                           | Conducted Test<br>(telecom port) | PASS   | Meets Class B Limit<br>Minimum passing margin is<br>-3.17 dB at 23.129 MHz |
|                           | Radiated Test<br>(30MHz ~ 2GHz)  | PASS   | Meets Class B Limit<br>Minimum passing margin is<br>-3.11 dB at 333.36 MHz |

**Note:** The EUT highest frequency generated **400MHz** and therefore the test frequency range was performed up to 2GHz for radiated emission test.



| <b>IMMUNITY (EN 55024:2010)</b> |   |               |   |
|---------------------------------|---|---------------|---|
| <b>Standard</b>                 | <b>Test Type</b>  | <b>Result</b> | <b>Remarks</b>                                    |
| IEC 61000-4-2:2008<br>ED.2.0    | Electrostatic discharge immunity test                                 | PASS          | Meets the requirements of Performance Criterion A |
| IEC 61000-4-3:2010<br>ED.3.2    | Radiated, radio-frequency, electromagnetic field immunity test        | PASS          | Meets the requirements of Performance Criterion A |
| IEC 61000-4-4:2011<br>ED.2.1    | Electrical fast transient / burst immunity test.                      | PASS          | Meets the requirements of Performance Criterion A |
| IEC 61000-4-5:2005<br>ED.2.0    | Surge immunity test   | PASS          | Meets the requirements of Performance Criterion A |
| IEC 61000-4-6:2008<br>ED.3.0    | Immunity to conducted disturbances, induced by radio-frequency fields | PASS          | Meets the requirements of Performance Criterion A |
| IEC 61000-4-8:2009<br>ED.2.0    | Power frequency magnetic field immunity test.                         | PASS          | Meets the requirements of Performance Criterion A |
| IEC 61000-4-11:2004<br>ED.2.0   | Voltage dips and short interruptions immunity tests                   | N/A           | Refer to item 3.3                                 |

## 2.1 MEASUREMENT UNCERTAINTY

Where relevant, the following measurement uncertainty levels have been estimated for tests performed on the EUT as specified in CISPR 16-4-2:

"This uncertainty represents an expanded uncertainty expressed at approximately the 95% confidence level using a coverage factor of k=2."

| <b>MEASUREMENT</b>                           | <b>FREQUENCY</b> | <b>UNCERTAINTY</b> |
|--|------------------|--------------------|
| Conducted emissions                          | 150kHz ~ 30MHz   | 2.41 dB            |
| Conducted Emission at Telecommunication port | 150kHz ~ 30MHz   | 2.9759 dB          |
| Radiated emissions                           | 30MHz ~ 1GHz     | 3.86 dB            |
|  | Above 1GHz       | 3.36 dB            |





### 3 GENERAL INFORMATION

#### 3.1 GENERAL DESCRIPTION OF EUT

|                            |                                     |
|----------------------------|-------------------------------------|
| <b>PRODUCT</b>             | Indoor Dome Network Camera          |
| <b>MODEL NO.</b>           | FD8135H                             |
| <b>POWER SUPPLY</b>        | AC adapter (AC 24V) or POE (DC 48V) |
| <b>DATA CABLE SUPPLIED</b> | N/A                                 |

**NOTE:**

1. The EUT is an indoor dome network camera.
2. For a more detailed features description, please refer to the manufacturer's specifications or the User's Manual.

### 3.2 DESCRIPTION OF TEST MODES

1. The EUT was pre-tested under following two kinds of LAN speed:

- ◆ 10 Mbps
- ◆ 100 Mbps

The worst emission level was found when the EUT was tested under **100Mbps** LAN speed, therefore only this condition was applied for final test.

2. During the test, the EUT consumes the following power input:

| Test Item  | Test Mode | Consumes Power from                          |
|--|-----------|--|
| Conducted, Conducted Test at Telecom Port & Radiated Tests | Mode 1    | AC adapter (AC 24V)                          |
|  | Mode 2    | POE (DC 48V)                                 |
| Immunity Tests   | Mode 1    | AC adapter (AC 24V)                          |
|  |           | (selected the worst mode from radiated test) |

### 3.3 GENERAL DESCRIPTION OF APPLIED STANDARDS

The EUT is a kind of ITE equipment and, according to the specifications of the manufacturers, must comply with the requirements of the following standards:

**EN 55022:2010, Class B**

**EN 55024:2010**

IEC 61000-4-2:2008 ED.2.0

IEC 61000-4-3:2010 ED.3.2

IEC 61000-4-4:2011 ED.2.1

IEC 61000-4-5:2005 ED.2.0

IEC 61000-4-6:2008 ED.3.0

IEC 61000-4-8:2009 ED.2.0

The EUT doesn't connect directly to AC mains lines or EUT consumes DC power and therefore, the standard, **IEC 61000-4-11**, was not performed for the test.

**Notes:** The above IEC basic standards are applied with latest version if customer has no special requirement

### 3.4 DESCRIPTION OF SUPPORT UNITS

The EUT has been tested as an independent unit together with other necessary accessories or support units. The following support units or accessories were used to form a representative test configuration during the tests.

#### 3.4.1 FOR EMISSION TEST

| NO. | PRODUCT   | BRAND                           | MODEL NO. | SERIAL NO.          | FCC ID           |
|-----|---|---------------------------------|-----------|---------------------|------------------|
| 1   | MICROPHONE  | Labtec                          | mic-333   | N/A                 | N/A              |
| 2   | EARPHONE  | PHILIPS                         | SBC HL145 | N/A                 | N/A              |
| 3   | NOTEBOOK COMPUTER                                 | CLEVO                           | M54N      | NKM540N06H0<br>1430 | FCC DoC Approved |
| 4   | AC Adapter  | Actiontop Electronics Co., Ltd. | AT-PSO220 | N/A                 | N/A              |
| 5   | 8-port 10/100/1000 Gigabit Switch with 4-port POE | NETGEAR                         | GS108P    | N/A                 | N/A              |

| NO. | SIGNAL CABLE DESCRIPTION OF THE ABOVE SUPPORT UNITS   |
|-----|---|
| 1   | 2.4 m wrapped shielded wire, terminated via drain wire, with 3.5 mm phone plug, w/o core.   |
| 2   | 1.2 m wrapped shielded wire, terminated with 3.5mm phone plug via drain wire, w/o core.     |
| 3   | 10m UTP LAN cable.<br>1.8m UTP LAN cable (For Mode 2 only)                                  |
| 4   | AC I/P: 110V/ 220V, 60Hz/ 50Hz<br>AC O/P: 24V, 2A<br>AC 2-pin, Non-Shielded DC Cable (1.8m) |
| 5   | AC I/P: 100-240V, 50/60Hz, 1.4A<br>DC O/P: 48.0V, 1.25A                                     |

**NOTE:** (1) All power cords of the above support units are non shielded (1.8m).  
(2) The support units 4 & 5 were provided by client.

### **TEST CONFIGURATION – For Mode 1**

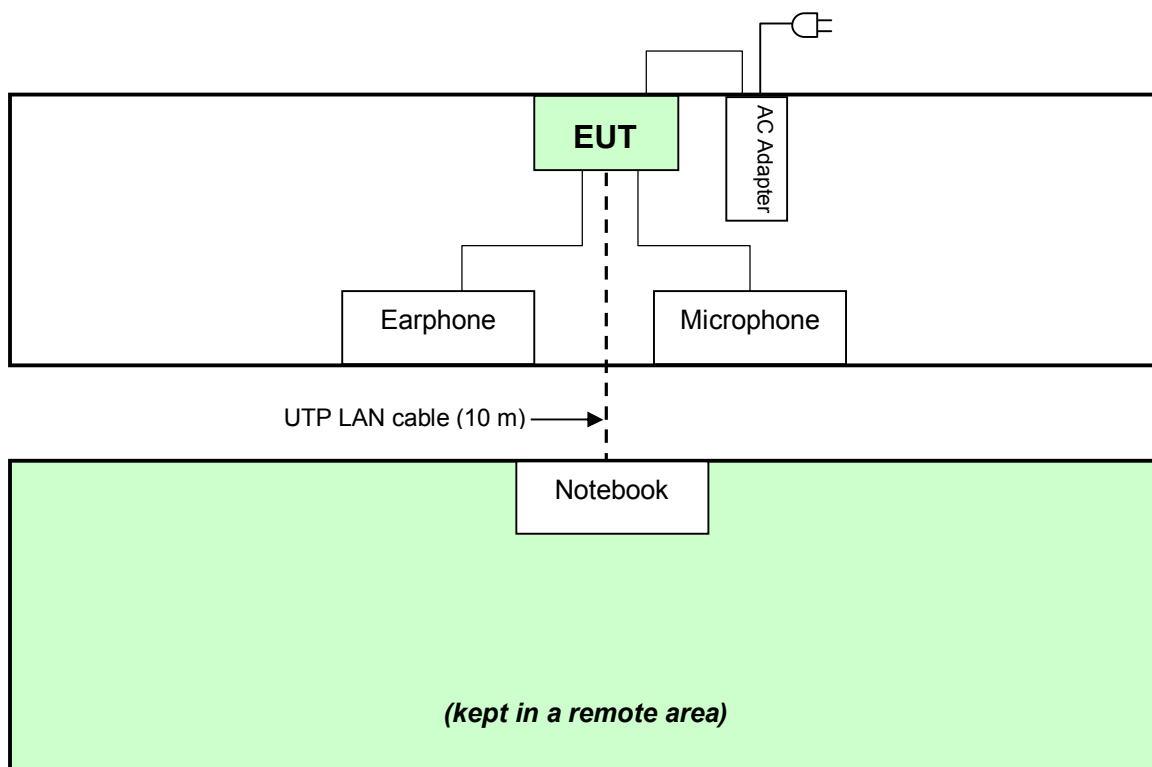

**TEST CONFIGURATION – For Mode 2**  
**(Conducted test & Conducted Test at Telecom Port)**

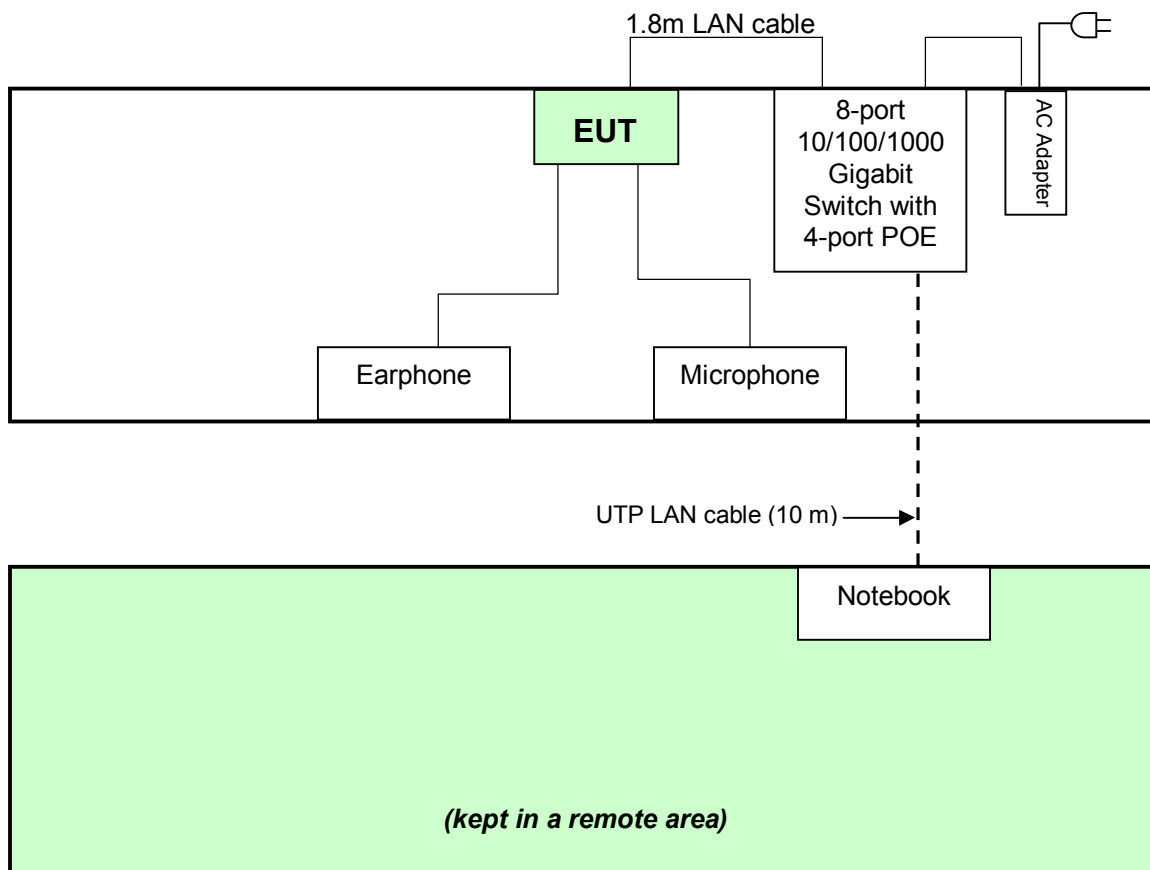

### TEST CONFIGURATION – For Mode 2 (Radiated Test only)

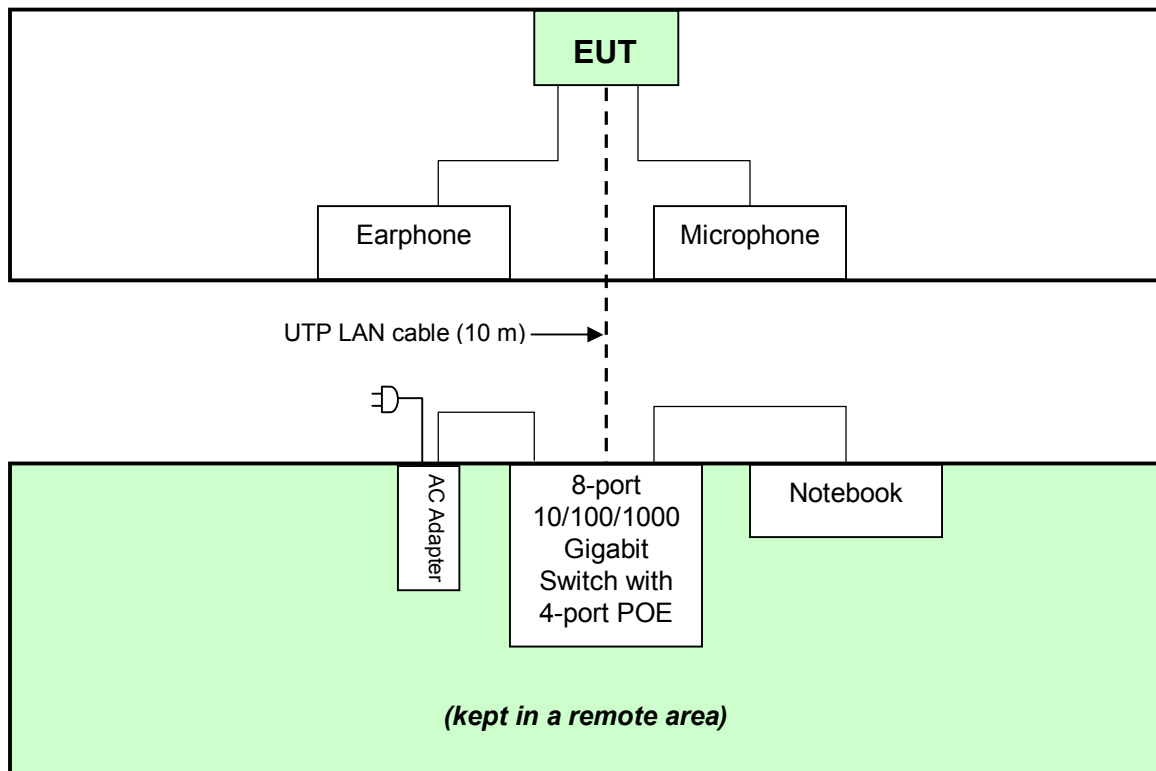



### 3.4.2 FOR IMMUNITY TEST

| NO. | PRODUCT   | BRAND                                 | MODEL NO. | SERIAL NO. | FCC ID           |
|-----|---|---------------------------------------|-----------|------------|------------------|
| 1   | EARPHONE+Mic.   | PHILIPS                               | SHM3300   | N/A        | N/A              |
| 2   | NOTEBOOK<br>COMPUTER                                    | DELL                                  | PP04X     | 9LRVR1S    | FCC DoC Approved |
| 3   | AC Adapter  | Actiontop<br>Electronics<br>Co., Ltd. | AT-PSO220 | N/A        | N/A              |
| 4   | 8-port 10/100/1000<br>Gigabit Switch with<br>4-port POE | NETGEAR                               | GS108P    | N/A        | N/A              |

| NO. | SIGNAL CABLE DESCRIPTION OF THE ABOVE SUPPORT UNITS   |
|-----|---|
| 1   | 1.2 m wrapped shielded wire, terminated with 3.5mm phone plug via drain wire, w/o core.     |
| 2   | 10m UTP LAN cable.<br>1.8m UTP LAN cable  |
| 3   | AC I/P: 110V/ 220V, 60Hz/ 50Hz<br>AC O/P: 24V, 2A<br>AC 2-pin, Non-Shielded DC Cable (1.8m) |
| 4   | AC I/P: 100-240V, 50/60Hz, 1.4A<br>DC O/P: 48.0V, 1.25A                                     |

**NOTE:** (1) All power cords of the above support units are non shielded (1.8m).  
(2) The support units 3-4 were provided by client.



## TEST CONFIGURATION

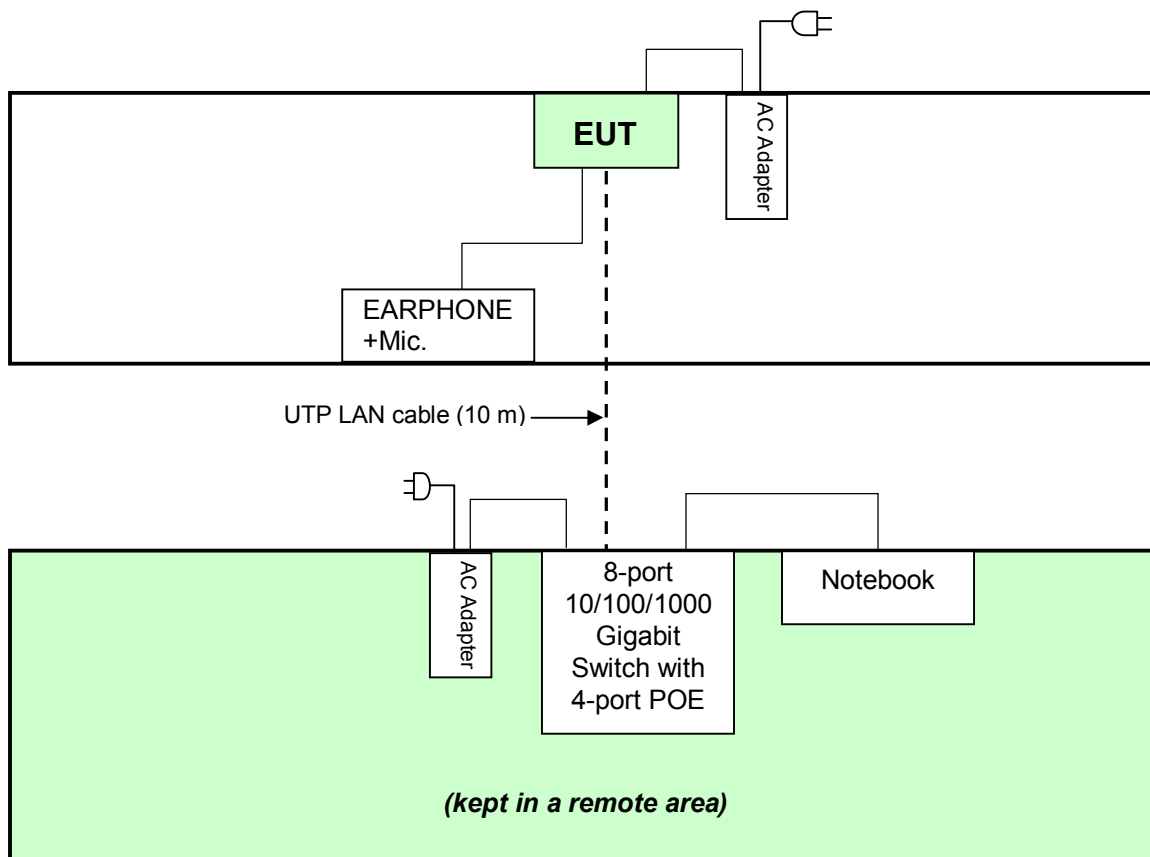

## 4 EMISSION TEST

### 4.1 CONDUCTED EMISSION MEASUREMENT

#### 4.1.1 LIMITS OF CONDUCTED EMISSION MEASUREMENT

**TEST STANDARD: EN 55022**

| FREQUENCY (MHz) | Class A (dBuV) |         | Class B (dBuV) |         |
|-----------------|----------------|---------|----------------|---------|
|                 | Quasi-peak     | Average | Quasi-peak     | Average |
| 0.15 - 0.5      | 79             | 66      | 66 - 56        | 56 - 46 |
| 0.50 - 5.0      | 73             | 60      | 56             | 46      |
| 5.0 - 30.0      | 73             | 60      | 60             | 50      |

- NOTE:**
- (1) The lower limit shall apply at the transition frequencies.
  - (2) The limit decreases in line with the logarithm of the frequency in the range of 0.15 to 0.50 MHz.
  - (3) All emanations from a class A/B digital device or system, including any network of conductors and apparatus connected thereto, shall not exceed the level of field strengths specified above.



## 4.1.2 TEST INSTRUMENTS

| DESCRIPTION & MANUFACTURER                                       | MODEL NO.           | SERIAL NO.   | CALIBRATED DATE | CALIBRATED UNTIL |
|--|---------------------|--------------|-----------------|------------------|
| ROHDE & SCHWARZ<br>Test Receiver                                 | ESCS 30             | 100276       | Jan. 04, 2012   | Jan. 03, 2013    |
| ROHDE & SCHWARZ<br>Artificial Mains Network<br>(for EUT)         | ESH3-Z5             | 100219       | Nov. 24, 2011   | Nov. 23, 2012    |
| LISN With Adapter<br>(for EUT)                                   | AD10                | C10Ada-001   | Nov. 24, 2011   | Nov. 23, 2012    |
| ROHDE & SCHWARZ<br>Artificial Mains Network<br>(for peripherals) | ESH3-Z5             | 100218       | Dec. 08, 2011   | Dec. 07, 2012    |
| Software   | ADT_Cond_V7.<br>3.7 | NA           | NA              | NA               |
| Software   | ADT_ISN_V7.3.<br>7  | NA           | NA              | NA               |
| RF cable (JYEBAO)  | 5D-FB               | Cable-C10.01 | Feb. 22, 2011   | Feb. 21, 2012    |
| SUHNER Terminator<br>(For ROHDE &<br>SCHWARZ LISN)               | 65BNC-5001          | E1-010773    | Feb. 26, 2011   | Feb. 25, 2012    |

- NOTE:**
1. The calibration interval of the above test instruments is 12 months and the calibrations are traceable to NML/ROC and NIST/USA.
  2. The test was performed in Shielded Room No. 10.
  3. The VCCI Site Registration No. C-1852.

## 4.1.3 TEST PROCEDURE

- a. The EUT was placed 0.4 meters from the conducting wall of the shielded room with EUT being connected to the power mains through a line impedance stabilization network (LISN). Other support units were connected to the power mains through another LISN. The two LISNs provide 50 Ohm/ 50uH of coupling impedance for the measuring instrument.
- b. Both lines of the power mains connected to the EUT were checked for maximum conducted interference.
- c. The frequency range from 150 kHz to 30 MHz was searched. Emission levels under (Limit - 20dB) were not recorded.

#### 4.1.4 DEVIATION FROM TEST STANDARD

No deviation

#### 4.1.5 TEST SETUP

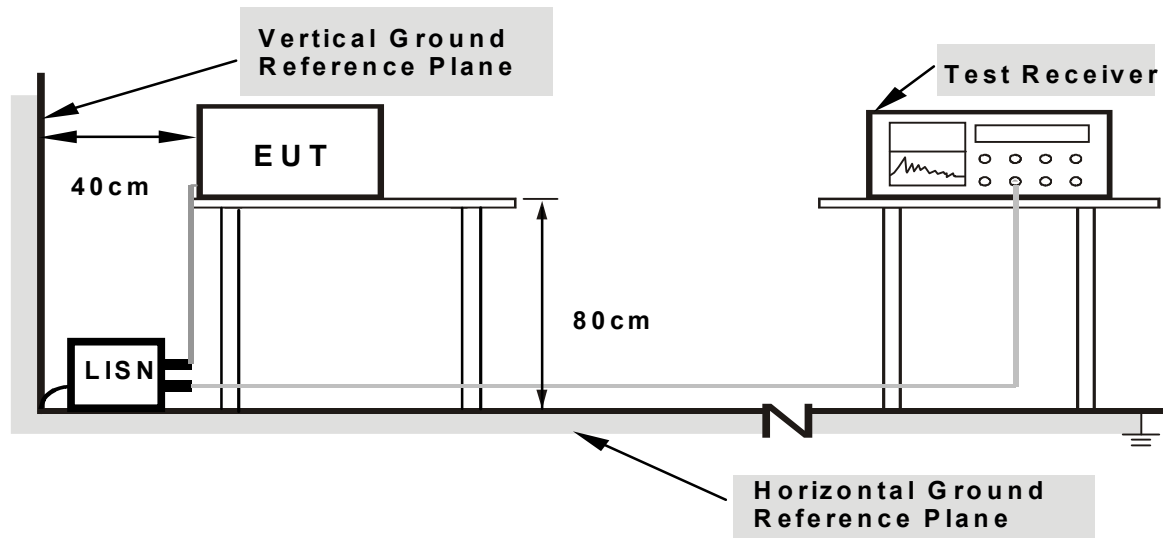

- Note:**
1. Support units were connected to second LISN.
  2. Both of LISNs (AMN) are 80cm from EUT and at least 80cm from other units and other metal planes support units.

For the actual test configuration, please refer to the related item – Photographs of the Test Configuration.

#### 4.1.6 EUT OPERATING CONDITIONS

- a. Connected the EUT with adapter or POE switch hub.
- b. Turned on the power of all equipment.
- c. EUT captured video signal.
- d. EUT sent and received messages from/to Server PC (kept in a remote area) via an UTP LAN cable (10 m). **(For Mode 1 only)**
- e. EUT sent and received messages from/to Server PC (kept in a remote area) via POE switch hub with an UTP LAN cable (10 m). **(For Mode 2 only)**
- f. EUT sent 1kHz audio signal to earphone.
- g. Steps c-g were repeated.

### 4.1.7 TEST RESULTS (1)

|                                 |                  |                             |          |
|---------------------------------|------------------|-----------------------------|----------|
| <b>TEST MODE</b>                | Mode 1           | <b>6DB BANDWIDTH</b>        | 9 kHz    |
| <b>INPUT POWER (AC ADAPTER)</b> | 24Vac            | <b>PHASE</b>                | Line (L) |
| <b>ENVIRONMENTAL CONDITIONS</b> | 21deg. C, 73% RH | <b>TESTED BY:</b> Brad Tung |          |

| No | Freq.<br>[MHz] | Corr.<br>Factor<br>(dB) | Reading Value |       | Emission Level |       | Limit     |       | Margin |        |
|----|----------------|-------------------------|---------------|-------|----------------|-------|-----------|-------|--------|--------|
|    |                |                         | [dB (uV)]     |       | [dB (uV)]      |       | [dB (uV)] |       | (dB)   |        |
|    |                |                         | Q.P.          | AV.   | Q.P.           | AV.   | Q.P.      | AV.   | Q.P.   | AV.    |
| 1  | 0.209          | 0.13                    | 49.79         | 18.09 | 49.92          | 18.22 | 63.26     | 53.26 | -13.34 | -35.04 |
| 2  | 0.252          | 0.15                    | 46.57         | 14.73 | 46.72          | 14.88 | 61.71     | 51.71 | -14.98 | -36.82 |
| 3  | 0.408          | 0.21                    | 41.01         | 9.33  | 41.22          | 9.54  | 57.69     | 47.69 | -16.47 | -38.15 |
| 4  | 1.484          | 0.27                    | 35.31         | 24.00 | 35.58          | 24.27 | 56.00     | 46.00 | -20.42 | -21.73 |
| 5  | 13.871         | 0.94                    | 42.25         | 35.73 | 43.19          | 36.67 | 60.00     | 50.00 | -16.81 | -13.33 |
| 6  | 27.508         | 1.48                    | 41.24         | 34.47 | 42.72          | 35.95 | 60.00     | 50.00 | -17.28 | -14.05 |

- REMARKS:**
1. Q.P. and AV. are abbreviations of quasi-peak and average individually.
  2. "-": The Quasi-peak reading value also meets average limit and measurement with the average detector is unnecessary.
  3. The emission levels of other frequencies were very low against the limit.
  4. Margin value = Emission level - Limit value
  5. Correction factor = Insertion loss + Cable loss
  6. Emission Level = Correction Factor + Reading Value.

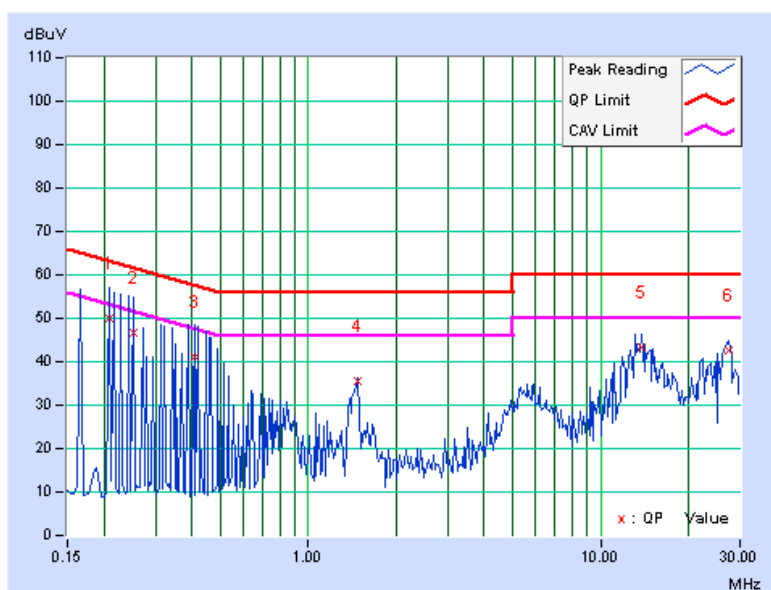

|                                 |                  |                             |             |
|---------------------------------|------------------|-----------------------------|-------------|
| <b>TEST MODE</b>                | Mode 1           | <b>6dB BANDWIDTH</b>        | 9 kHz       |
| <b>INPUT POWER (AC ADAPTER)</b> | 24Vac            | <b>PHASE</b>                | Neutral (N) |
| <b>ENVIRONMENTAL CONDITIONS</b> | 21deg. C, 73% RH | <b>TESTED BY:</b> Brad Tung |             |

| No | Freq.<br>[MHz] | Corr.<br>Factor<br>(dB) | Reading Value |       | Emission Level |       | Limit     |       | Margin |        |
|----|----------------|-------------------------|---------------|-------|----------------|-------|-----------|-------|--------|--------|
|    |                |                         | [dB (uV)]     |       | [dB (uV)]      |       | [dB (uV)] |       | (dB)   |        |
|    |                |                         | Q.P.          | AV.   | Q.P.           | AV.   | Q.P.      | AV.   | Q.P.   | AV.    |
| 1  | 0.162          | 0.13                    | 47.35         | 15.43 | 47.48          | 15.56 | 65.38     | 55.38 | -17.90 | -39.82 |
| 2  | 0.232          | 0.14                    | 42.72         | 10.90 | 42.86          | 11.04 | 62.38     | 52.38 | -19.51 | -41.33 |
| 3  | 0.435          | 0.21                    | 28.36         | 11.06 | 28.57          | 11.27 | 57.15     | 47.15 | -28.58 | -35.88 |
| 4  | 1.457          | 0.26                    | 35.35         | 28.70 | 35.61          | 28.96 | 56.00     | 46.00 | -20.39 | -17.04 |
| 5  | 13.875         | 0.74                    | 41.83         | 35.73 | 42.57          | 36.47 | 60.00     | 50.00 | -17.43 | -13.53 |
| 6  | 21.906         | 0.94                    | 41.97         | 34.43 | 42.91          | 35.37 | 60.00     | 50.00 | -17.09 | -14.63 |

- REMARKS:**
1. Q.P. and AV. are abbreviations of quasi-peak and average individually.
  2. "-": The Quasi-peak reading value also meets average limit and measurement with the average detector is unnecessary.
  3. The emission levels of other frequencies were very low against the limit.
  4. Margin value = Emission level - Limit value
  5. Correction factor = Insertion loss + Cable loss
  6. Emission Level = Correction Factor + Reading Value.

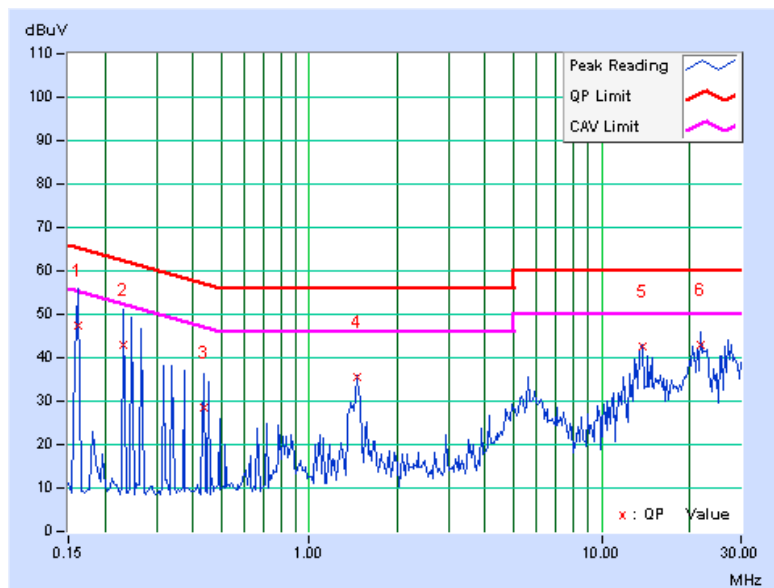

### 4.1.8 TEST RESULTS (2)

|                                 |                  |                             |          |
|---------------------------------|------------------|-----------------------------|----------|
| <b>TEST MODE</b>                | Mode 2           | <b>6DB BANDWIDTH</b>        | 9 kHz    |
| <b>INPUT POWER (POE)</b>        | 48Vdc            | <b>PHASE</b>                | Line (L) |
| <b>ENVIRONMENTAL CONDITIONS</b> | 21deg. C, 73% RH | <b>TESTED BY:</b> Brad Tung |          |

| No       | Freq.<br>[MHz] | Corr.<br>Factor<br>(dB) | Reading Value |              | Emission Level |              | Limit        |              | Margin        |              |
|----------|----------------|-------------------------|---------------|--------------|----------------|--------------|--------------|--------------|---------------|--------------|
|          |                |                         | [dB (uV)]     |              | [dB (uV)]      |              | [dB (uV)]    |              | (dB)          |              |
|          |                |                         | Q.P.          | AV.          | Q.P.           | AV.          | Q.P.         | AV.          | Q.P.          | AV.          |
| 1        | 0.150          | 0.13                    | 45.57         | 26.64        | 45.70          | 26.77        | 66.00        | 56.00        | -20.29        | -29.22       |
| <b>2</b> | <b>0.373</b>   | <b>0.20</b>             | <b>46.81</b>  | <b>41.54</b> | <b>47.01</b>   | <b>41.74</b> | <b>58.44</b> | <b>48.44</b> | <b>-11.43</b> | <b>-6.70</b> |
| 3        | 0.865          | 0.23                    | 35.88         | 30.80        | 36.11          | 31.03        | 56.00        | 46.00        | -19.89        | -14.97       |
| 4        | 1.359          | 0.26                    | 39.60         | 32.81        | 39.86          | 33.07        | 56.00        | 46.00        | -16.14        | -12.93       |
| 5        | 2.508          | 0.34                    | 34.33         | 25.20        | 34.67          | 25.54        | 56.00        | 46.00        | -21.33        | -20.46       |
| 6        | 5.922          | 0.53                    | 26.06         | 20.36        | 26.59          | 20.89        | 60.00        | 50.00        | -33.41        | -29.11       |

- REMARKS:**
1. Q.P. and AV. are abbreviations of quasi-peak and average individually.
  2. "-": The Quasi-peak reading value also meets average limit and measurement with the average detector is unnecessary.
  3. The emission levels of other frequencies were very low against the limit.
  4. Margin value = Emission level - Limit value
  5. Correction factor = Insertion loss + Cable loss
  6. Emission Level = Correction Factor + Reading Value.

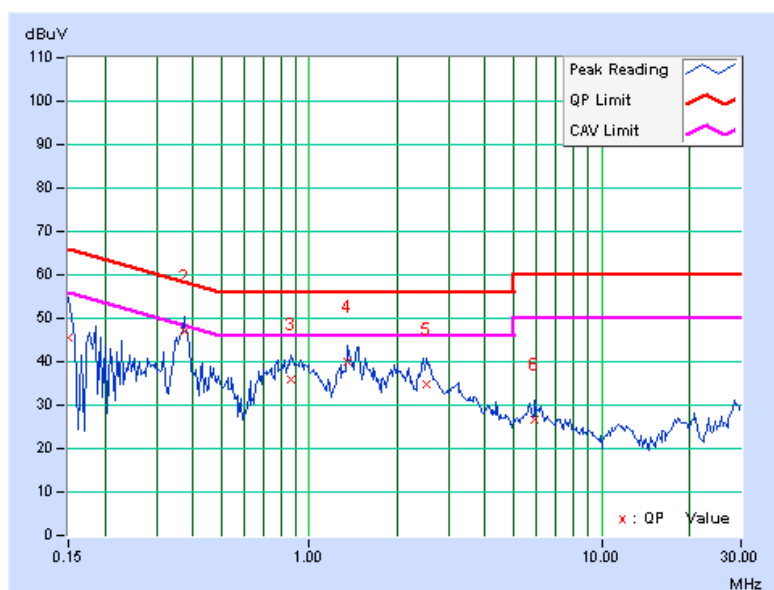

|                                 |                  |                             |             |
|---------------------------------|------------------|-----------------------------|-------------|
| <b>TEST MODE</b>                | Mode 2           | <b>6dB BANDWIDTH</b>        | 9 kHz       |
| <b>INPUT POWER (POE)</b>        | 48Vdc            | <b>PHASE</b>                | Neutral (N) |
| <b>ENVIRONMENTAL CONDITIONS</b> | 21deg. C, 73% RH | <b>TESTED BY:</b> Brad Tung |             |

| No | Freq.<br>[MHz] | Corr.<br>Factor<br>(dB) | Reading Value |       | Emission Level |       | Limit     |       | Margin |        |
|----|----------------|-------------------------|---------------|-------|----------------|-------|-----------|-------|--------|--------|
|    |                |                         | [dB (uV)]     |       | [dB (uV)]      |       | [dB (uV)] |       | (dB)   |        |
|    |                |                         | Q.P.          | AV.   | Q.P.           | AV.   | Q.P.      | AV.   | Q.P.   | AV.    |
| 1  | 0.166          | 0.13                    | 42.69         | 24.55 | 42.82          | 24.68 | 65.18     | 55.18 | -22.36 | -30.50 |
| 2  | 0.377          | 0.20                    | 46.30         | 41.48 | 46.50          | 41.68 | 58.35     | 48.35 | -11.85 | -6.67  |
| 3  | 0.806          | 0.23                    | 36.03         | 30.61 | 36.26          | 30.84 | 56.00     | 46.00 | -19.74 | -15.16 |
| 4  | 1.469          | 0.26                    | 40.66         | 31.20 | 40.92          | 31.46 | 56.00     | 46.00 | -15.08 | -14.54 |
| 5  | 2.531          | 0.32                    | 36.53         | 27.87 | 36.85          | 28.19 | 56.00     | 46.00 | -19.15 | -17.81 |
| 6  | 5.945          | 0.48                    | 25.26         | 19.92 | 25.74          | 20.40 | 60.00     | 50.00 | -34.26 | -29.60 |

- REMARKS:**
1. Q.P. and AV. are abbreviations of quasi-peak and average individually.
  2. "-": The Quasi-peak reading value also meets average limit and measurement with the average detector is unnecessary.
  3. The emission levels of other frequencies were very low against the limit.
  4. Margin value = Emission level - Limit value
  5. Correction factor = Insertion loss + Cable loss
  6. Emission Level = Correction Factor + Reading Value.

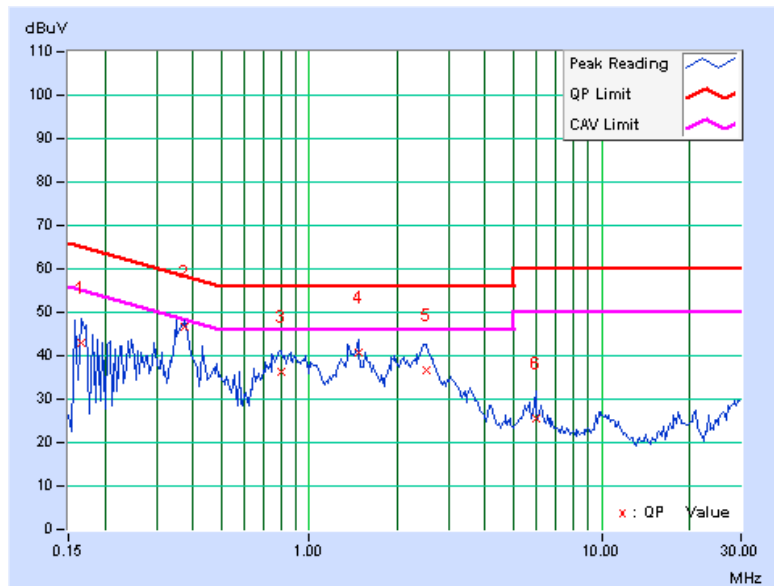



## 4.2 CONDUCTED EMISSION MEASUREMENT AT TELECOMMUNICATION PORTS

### 4.2.1 LIMIT OF CONDUCTED COMMON MODE DISTURBANCE AT TELECOMMUNICATION PORTS

**TEST STANDARD: EN 55022  
FOR CLASS A EQUIPMENT**

| FREQUENCY<br>(MHz) | Voltage Limit (dBuV) |         | Current Limit (dBuA) |         |
|--------------------|----------------------|---------|----------------------|---------|
|                    | Quasi-peak           | Average | Quasi-peak           | Average |
| 0.15 - 0.5         | 97 – 87              | 84 - 74 | 53 – 43              | 40 – 30 |
| 0.5 - 30.0         | 87                   | 74      | 43                   | 30      |

### FOR CLASS B EQUIPMENT

| FREQUENCY<br>(MHz) | Voltage Limit (dBuV) |         | Current Limit (dBuA) |         |
|--------------------|----------------------|---------|----------------------|---------|
|                    | Quasi-peak           | Average | Quasi-peak           | Average |
| 0.15 - 0.5         | 84 - 74              | 74 - 64 | 40 – 30              | 30 – 20 |
| 0.5 - 30.0         | 74                   | 64      | 30                   | 20      |

**NOTE:** (1) The limits decrease linearly with the logarithm of the frequency in the range 0.15 MHz to 0.5 MHz.



## 4.2.2 TEST INSTRUMENTS

| DESCRIPTION & MANUFACTURER                                       | MODEL NO.       | SERIAL NO.   | CALIBRATED DATE | CALIBRATED UNTIL |
|--|-----------------|--------------|-----------------|------------------|
| ROHDE & SCHWARZ<br>Test Receiver                                 | ESCS 30         | 100276       | Jan. 04, 2012   | Jan. 03, 2013    |
| ROHDE & SCHWARZ<br>Artificial Mains Network<br>(for EUT)         | ESH3-Z5         | 100219       | Nov. 24, 2011   | Nov. 23, 2012    |
| LISN With Adapter<br>(for EUT)                                   | AD10            | C10Ada-001   | Nov. 24, 2011   | Nov. 23, 2012    |
| ROHDE & SCHWARZ<br>Artificial Mains Network<br>(for peripherals) | ESH3-Z5         | 100218       | Dec. 08, 2011   | Dec. 07, 2012    |
| Software   | ADT_Cond_V7.3.7 | NA           | NA              | NA               |
| Software   | ADT_ISN_V7.3.7  | NA           | NA              | NA               |
| RF cable (JYEBAO)  | 5D-FB           | Cable-C10.01 | Feb. 22, 2011   | Feb. 21, 2012    |
| SUHNER Terminator<br>(For ROHDE &<br>SCHWARZ LISN)               | 65BNC-5001      | E1-010773    | Feb. 26, 2011   | Feb. 25, 2012    |
| FCC ISN  | F-071115-1057-1 | 20652        | Jan. 30, 2012   | Jan. 29, 2013    |

- NOTE:**
1. The calibration interval of the above test instruments is 12 months and the calibrations are traceable to NML/ROC and NIST/USA.
  2. The test was performed in Shielded Room No. 10.
  3. The VCCI Site Registration No. T-1611.

### 4.2.3 TEST PROCEDURE

For ISN:

- a. The EUT was placed 0.4 meters from the conducting wall of the shielded room and connected to the power mains through a line impedance stabilization network (LISN). Other support units were connected to the power mains through another LISN.
- b. Voltage at the measurement port of the ISN was detected, the reading was corrected by adding the voltage division factor of the ISN, and was compared to the voltage limits.
- c. The disturbance levels and the frequencies of at least six highest disturbances were recorded from each telecommunication port, which comprises the EUT.

For Current Probe:

- a. Current probe shall be placed at 0.1m from the ISN.
- b. Current at the measurement port of the ISN was detected, the reading was corrected by adding the current division factor of the current probe, and was compared to the current limits.
- c. The disturbance levels and the frequencies of at least six highest disturbances were recorded from each telecommunication port, which comprises the EUT
- d. Break the insulation and connect a  $150\Omega$  resistor from the outside surface of the shield to ground and apply a clamp between  $150\Omega$  connection and associated equipment (For STP LAN only).

For Voltage Probe:

- a. The EUT was placed 0.4 meters from the conducting wall of the shielded room and connected to the power mains through a line impedance stabilization network (LISN). Other support units were connected to the power mains through another LISN.
- b. Voltage at the measurement port of the voltage probe was detected, the reading was corrected by adding the voltage division factor of the voltage probe, and was compared to the voltage limits.
- c. The disturbance levels and the frequencies of at least six highest disturbances were recorded from each telecommunication port, which comprises the EUT.

### 4.2.4 DEVIATION FROM TEST STANDARD

No deviation

## 4.2.5 TEST SETUP

For ISN & Current Probe (UTP LAN cable):

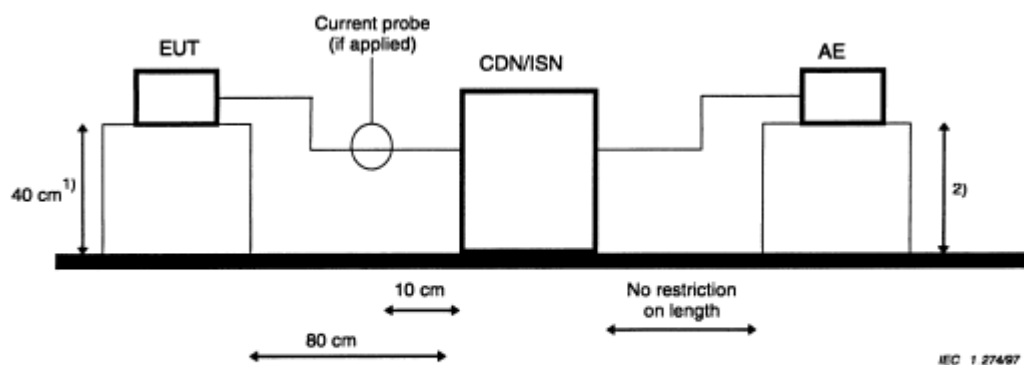

AE = Associated equipment  
EUT = Equipment under test

- 1) Distance to the reference groundplane (vertical or horizontal).  
2) Distance to the reference groundplane is not critical.

For Current Probe (STP LAN cable):

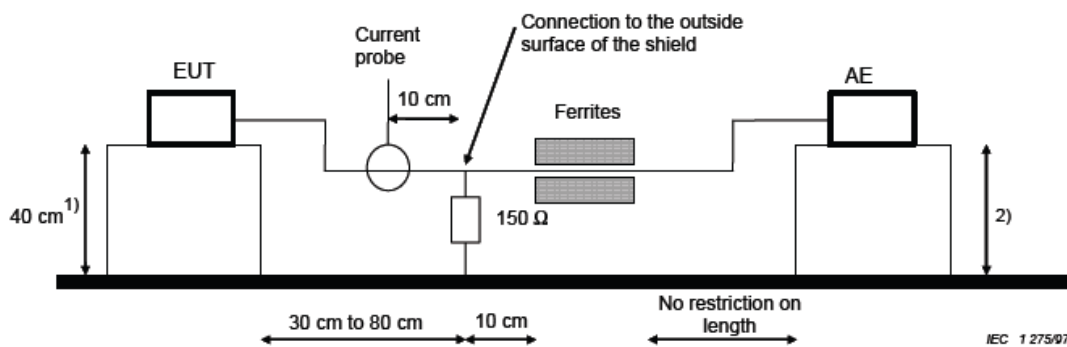

AE = Associated equipment  
EUT = Equipment under test

For Voltage & Current Probe:

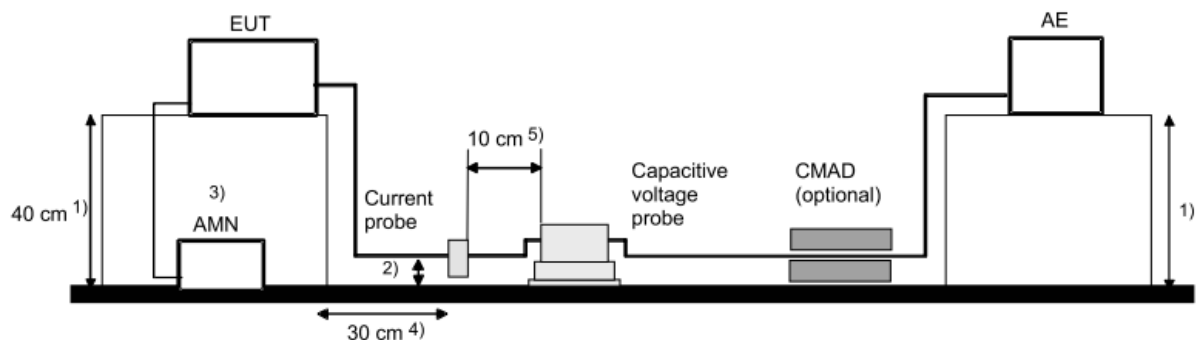

IEC 1353/08

AE = Associated equipment  
 EUT = Equipment under test  
 CMAD = Common mode Absorbing Device

For the actual test configuration, please refer to the related item – Photographs of the Test Configuration.

**NOTE:**

1. The methods of conformance testing were selected according to the EN55022:2010, section: 9.6.1 of measurement method using an ISN with a longitudinal conversion loss (LCL) as defined in section: 9.6.2.
2. When measurements were performed on a single unscreened balanced pair, an adequate ISN for two wires were used; when performed on unscreened cables containing two balanced pairs, an adequate ISN for four wires were used; when performed on unscreened cables containing four balanced pairs, an adequate ISN for eight wires were used.
3. The communication function of EUT was executed and ISN was connected between EUT and associated equipment and the ISN was connected directly to reference ground plane.

#### 4.2.6 EUT OPERATING CONDITIONS

- a. Connected the EUT with adapter or POE switch hub.
- b. Turned on the power of all equipment.
- c. EUT captured video signal.
- d. Server PC (kept in a remote area) run "ping.exe" (10% of transmission rate 10Mbps) and "TfGen.exe" (10% of transmission rate 100Mbps) then sent and received messages to/ from EUT via an UTP LAN cable (10m). **(For Mode 1 only)**
- e. Server PC (kept in a remote area) run "ping.exe" (10% of transmission rate 10Mbps) and "TfGen.exe" (10% of transmission rate 100Mbps) then sent and received messages to/ from EUT via POE switch hub with an UTP LAN cable (10 m). **(For Mode 2 only)**
- f. EUT sent 1kHz audio signal to earphone.
- g. Steps c-g were repeated.

### 4.2.7 TEST RESULTS (1)

|                                 |                  |                             |                            |
|---------------------------------|------------------|-----------------------------|----------------------------|
| <b>TEST MODE</b>                | Mode 1           | <b>6dB BANDWIDTH</b>        | 9 kHz                      |
| <b>INPUT POWER (AC ADAPTER)</b> | 24Vac            | <b>PHASE</b>                | RJ45 TELECOM PORT (10Mbps) |
| <b>ENVIRONMENTAL CONDITIONS</b> | 22deg. C, 73% RH | <b>TESTED BY:</b> Brad Tung |                            |

| No | Freq.<br>[MHz] | Corr.<br>Factor<br>(dB) | Reading Value |       | Emission Level |       | Limit     |       | Margin |        |
|----|----------------|-------------------------|---------------|-------|----------------|-------|-----------|-------|--------|--------|
|    |                |                         | [dB (uV)]     |       | [dB (uV)]      |       | [dB (uV)] |       | (dB)   |        |
|    |                |                         | Q.P.          | AV.   | Q.P.           | AV.   | Q.P.      | A.V.  | Q.P.   | A.V.   |
| 1  | 0.220          | 9.90                    | 43.62         | 20.19 | 53.52          | 30.09 | 80.81     | 70.81 | -27.29 | -40.72 |
| 2  | 0.396          | 9.81                    | 40.45         | 27.40 | 50.26          | 37.21 | 75.93     | 65.93 | -25.68 | -28.73 |
| 3  | 2.496          | 9.51                    | 37.13         | 21.94 | 46.64          | 31.45 | 74.00     | 64.00 | -27.36 | -32.55 |
| 4  | 10.000         | 9.63                    | 38.76         | 18.40 | 48.39          | 28.03 | 74.00     | 64.00 | -25.61 | -35.97 |
| 5  | 16.547         | 9.93                    | 48.17         | 38.29 | 58.10          | 48.22 | 74.00     | 64.00 | -15.90 | -15.78 |
| 6  | 27.254         | 10.51                   | 46.07         | 40.78 | 56.58          | 51.29 | 74.00     | 64.00 | -17.42 | -12.71 |

- REMARKS:
1. Q.P. and AV. are abbreviations of quasi-peak and average individually.
  2. "-": The Quasi-peak reading value also meets average limit and measurement with the average detector is unnecessary.
  3. The emission levels of other frequencies were very low against the limit.
  4. Margin value = Emission level - Limit value
  5. Correction factor = Insertion loss + Cable loss
  6. Emission Level = Correction Factor + Reading Value.

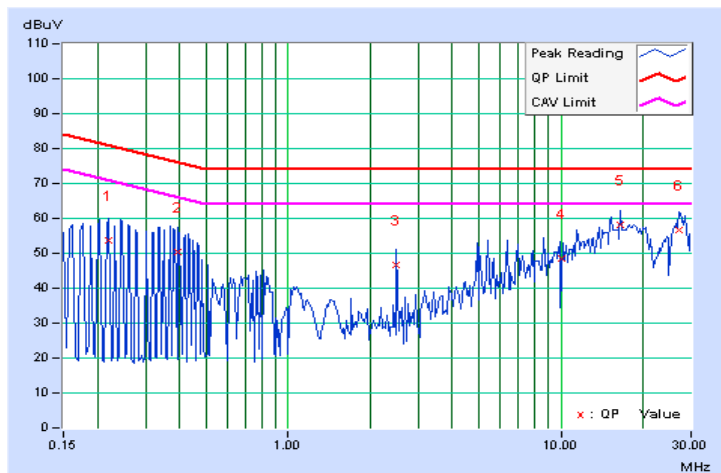



A D T

|                                 |                  |                             |                             |
|---------------------------------|------------------|-----------------------------|-----------------------------|
| <b>TEST MODE</b>                | Mode 1           | <b>6dB BANDWIDTH</b>        | 9 kHz                       |
| <b>INPUT POWER (AC ADAPTER)</b> | 24Vac            | <b>PHASE</b>                | RJ45 TELECOM PORT (100Mbps) |
| <b>ENVIRONMENTAL CONDITIONS</b> | 22deg. C, 73% RH | <b>TESTED BY:</b> Brad Tung |                             |

| No       | Freq.<br>[MHz] | Corr.<br>Factor<br>(dB) | Reading Value<br>[dB (uV)] |              | Emission Level<br>[dB (uV)] |              | Limit<br>[dB (uV)] |              | Margin<br>(dB) |              |
|----------|----------------|-------------------------|----------------------------|--------------|-----------------------------|--------------|--------------------|--------------|----------------|--------------|
|          |                |                         | Q.P.                       | AV.          | Q.P.                        | AV.          | Q.P.               | A.V.         | Q.P.           | A.V.         |
|          | 1              | 0.240                   | 9.89                       | 45.47        | 13.94                       | 55.36        | 23.83              | 80.10        | 70.10          | -24.74       |
| 2        | 0.384          | 9.81                    | 42.19                      | 19.27        | 52.00                       | 29.08        | 76.18              | 66.18        | -24.18         | -37.10       |
| 3        | 1.023          | 9.58                    | 36.67                      | 33.87        | 46.25                       | 43.45        | 74.00              | 64.00        | -27.75         | -20.55       |
| 4        | 7.922          | 9.59                    | 43.74                      | 41.02        | 53.33                       | 50.61        | 74.00              | 64.00        | -20.67         | -13.39       |
| 5        | 21.664         | 10.17                   | 52.33                      | 48.36        | 62.50                       | 58.53        | 74.00              | 64.00        | -11.50         | -5.47        |
| <b>6</b> | <b>23.129</b>  | <b>10.25</b>            | <b>53.77</b>               | <b>50.58</b> | <b>64.02</b>                | <b>60.83</b> | <b>74.00</b>       | <b>64.00</b> | <b>-9.98</b>   | <b>-3.17</b> |

- REMARKS:
1. Q.P. and AV. are abbreviations of quasi-peak and average individually.
  2. "-": The Quasi-peak reading value also meets average limit and measurement with the average detector is unnecessary.
  3. The emission levels of other frequencies were very low against the limit.
  4. Margin value = Emission level - Limit value
  5. Correction factor = Insertion loss + Cable loss
  6. Emission Level = Correction Factor + Reading Value.

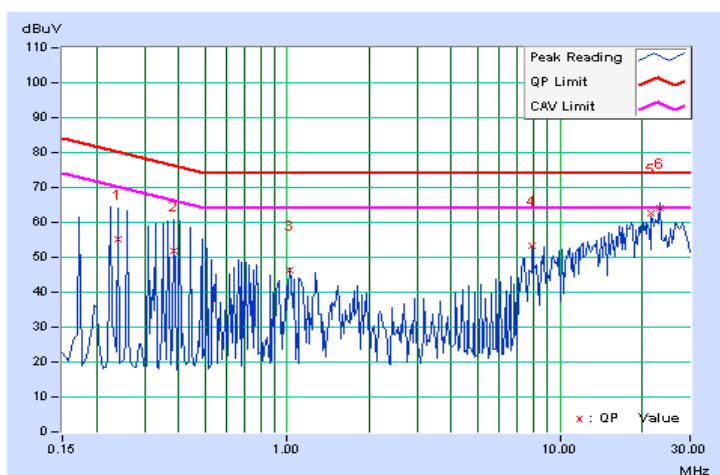



## 4.2.8 TEST RESULTS (2)

|                                 |                  |                             |                            |
|---------------------------------|------------------|-----------------------------|----------------------------|
| <b>TEST MODE</b>                | Mode 2           | <b>6dB BANDWIDTH</b>        | 9 kHz                      |
| <b>INPUT POWER (POE)</b>        | 48Vdc            | <b>PHASE</b>                | RJ45 TELECOM PORT (10Mbps) |
| <b>ENVIRONMENTAL CONDITIONS</b> | 22deg. C, 73% RH | <b>TESTED BY:</b> Brad Tung |                            |

| No | Freq.<br>[MHz] | Corr.<br>Factor<br>(dB) | Reading Value |       | Emission Level |       | Limit     |       | Margin |        |
|----|----------------|-------------------------|---------------|-------|----------------|-------|-----------|-------|--------|--------|
|    |                |                         | [dB (uV)]     |       | [dB (uV)]      |       | [dB (uV)] |       | (dB)   |        |
|    |                |                         | Q.P.          | AV.   | Q.P.           | AV.   | Q.P.      | A.V.  | Q.P.   | A.V.   |
| 1  | 0.369          | 9.82                    | 58.90         | 51.81 | 68.72          | 61.63 | 76.53     | 66.53 | -7.81  | -4.90  |
| 2  | 0.865          | 9.62                    | 48.67         | 44.03 | 58.29          | 53.65 | 74.00     | 64.00 | -15.71 | -10.35 |
| 3  | 1.469          | 9.54                    | 48.15         | 43.47 | 57.69          | 53.01 | 74.00     | 64.00 | -16.31 | -10.99 |
| 4  | 2.566          | 9.51                    | 44.72         | 36.95 | 54.23          | 46.46 | 74.00     | 64.00 | -19.77 | -17.54 |
| 5  | 10.000         | 9.63                    | 38.96         | 23.56 | 48.59          | 33.19 | 74.00     | 64.00 | -25.41 | -30.81 |
| 6  | 11.344         | 9.69                    | 36.10         | 22.65 | 45.79          | 32.34 | 74.00     | 64.00 | -28.21 | -31.66 |

- REMARKS:
1. Q.P. and AV. are abbreviations of quasi-peak and average individually.
  2. "-": The Quasi-peak reading value also meets average limit and measurement with the average detector is unnecessary.
  3. The emission levels of other frequencies were very low against the limit.
  4. Margin value = Emission level - Limit value
  5. Correction factor = Insertion loss + Cable loss
  6. Emission Level = Correction Factor + Reading Value.

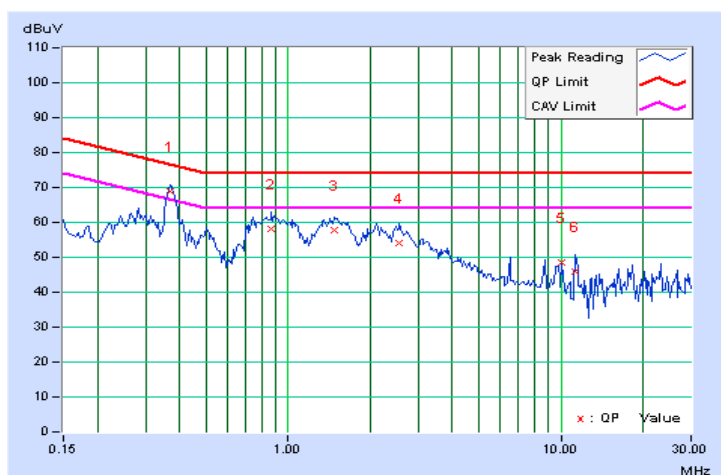

|                                 |                  |                             |                             |
|---------------------------------|------------------|-----------------------------|-----------------------------|
| <b>TEST MODE</b>                | Mode 2           | <b>6dB BANDWIDTH</b>        | 9 kHz                       |
| <b>INPUT POWER (POE)</b>        | 48Vdc            | <b>PHASE</b>                | RJ45 TELECOM PORT (100Mbps) |
| <b>ENVIRONMENTAL CONDITIONS</b> | 22deg. C, 73% RH | <b>TESTED BY:</b> Brad Tung |                             |

| No | Freq.<br>[MHz] | Corr.<br>Factor<br>(dB) | Reading Value<br>[dB (uV)] |       | Emission Level<br>[dB (uV)] |       | Limit<br>[dB (uV)] |       | Margin<br>(dB) |        |
|----|----------------|-------------------------|----------------------------|-------|-----------------------------|-------|--------------------|-------|----------------|--------|
|    |                |                         | Q.P.                       | AV.   | Q.P.                        | AV.   | Q.P.               | A.V.  | Q.P.           | A.V.   |
|    |                |                         | 1                          | 0.298 | 9.86                        | 50.11 | 45.73              | 59.97 | 55.59          | 78.29  |
| 2  | 0.373          | 9.82                    | 58.20                      | 51.61 | 68.02                       | 61.43 | 76.44              | 66.44 | -8.42          | -5.01  |
| 3  | 0.810          | 9.63                    | 49.55                      | 44.33 | 59.18                       | 53.96 | 74.00              | 64.00 | -14.82         | -10.04 |
| 4  | 1.359          | 9.55                    | 49.05                      | 43.05 | 58.60                       | 52.60 | 74.00              | 64.00 | -15.40         | -11.40 |
| 5  | 2.008          | 9.50                    | 46.75                      | 41.95 | 56.25                       | 51.45 | 74.00              | 64.00 | -17.75         | -12.55 |
| 6  | 19.711         | 10.07                   | 36.16                      | 33.54 | 46.23                       | 43.61 | 74.00              | 64.00 | -27.77         | -20.39 |

- REMARKS:
1. Q.P. and AV. are abbreviations of quasi-peak and average individually.
  2. "-": The Quasi-peak reading value also meets average limit and measurement with the average detector is unnecessary.
  3. The emission levels of other frequencies were very low against the limit.
  4. Margin value = Emission level - Limit value
  5. Correction factor = Insertion loss + Cable loss
  6. Emission Level = Correction Factor + Reading Value.

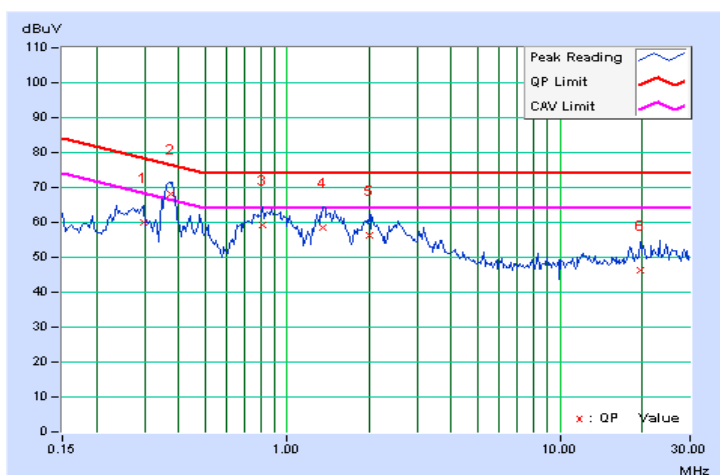

## 4.3 RADIATED EMISSION MEASUREMENT

### 4.3.1 LIMITS OF RADIATED EMISSION MEASUREMENT

**TEST STANDARD: EN 55022**

**FOR FREQUENCY BELOW 1000 MHz**

| FREQUENCY<br>(MHz) | Class A (at 10m) | Class B (at 10m) |
|--------------------|------------------|------------------|
|                    | dBuV/m           | dBuV/m           |
| 30 – 230           | 40               | 30               |
| 230 – 1000         | 47               | 37               |

**FOR FREQUENCY ABOVE 1000 MHz**

| FREQUENCY (GHz) | Class A (dBuV/m) (at 3m) |         | Class B (dBuV/m) (at 3m) |         |
|-----------------|--------------------------|---------|--------------------------|---------|
|                 | PEAK                     | AVERAGE | PEAK                     | AVERAGE |
| 1 to 3          | 76                       | 56      | 70                       | 50      |
| 3 to 6          | 80                       | 60      | 74                       | 54      |

- NOTE:** (1) The lower limit shall apply at the transition frequencies.  
 (2) Emission level (dBuV/m) = 20 log Emission level (uV/m).  
 (3) All emanation from a class A/B digital device or system, including any network of conductors and apparatus connected thereto, shall not exceed the level of field strengths specified above.

### FREQUENCY RANGE OF RADIATED MEASUREMENT (For unintentional radiators)

| Highest frequency generated or used in the device or on which the device operates or tunes (MHz) | Upper frequency of measurement range (MHz)                         |
|--|--|
| Below 108  | 1000   |
| 108 – 500  | 2000   |
| 500 – 1000   | 5000   |
| Above 1000   | Up to 5 times of the highest frequency or 6 GHz, whichever is less |



## 4.3.2 TEST INSTRUMENTS

### Frequency Range 30MHz~1GHz

| DESCRIPTION & MANUFACTURER    | MODEL NO.                | SERIAL NO.   | CALIBRATED DATE | CALIBRATED UNTIL |
|-------------------------------|--------------------------|--------------|-----------------|------------------|
| ROHDE & SCHWARZ TEST RECEIVER | ESCS30                   | 847793/022   | May. 05, 2011   | May. 04, 2012    |
| CHASE BILOG Antenna           | CBL6111C                 | 2765         | Apr. 14, 2011   | Apr. 13, 2012    |
| CT Turn Table                 | TT100                    | CT-0055      | NA              | NA               |
| CT Tower                      | AT100                    | CT-0055      | NA              | NA               |
| Software                      | ADT_Radiated_V7.6.15.9.2 | NA           | NA              | NA               |
| ADT RF Switches BOX           | EMH-011                  | 08005        | Jun. 21, 2011   | Jun. 20, 2012    |
| WOKEN RF cable                | 8D                       | CABLE-ST6-01 | Jun. 21, 2011   | Jun. 20, 2012    |

- NOTE:**
1. The calibration interval of the above test instruments is 12 months. And the calibrations are traceable to NML/ROC and NIST/USA.
  2. The test was performed in Open Site No. 6.
  3. The VCCI Site Registration No. R-728.
  4. The FCC Site Registration No. 90427.

### Frequency Range above 1GHz

| DESCRIPTION & MANUFACTURER | MODEL NO.                | SERIAL NO.  | CALIBRATED DATE | CALIBRATED UNTIL |
|----------------------------|--------------------------|-------------|-----------------|------------------|
| Agilent Spectrum           | E4446A                   | MY46180403  | Jun. 22, 2011   | Jun. 21, 2012    |
| Agilent Preamplifier       | 8449B                    | 3008A01201  | Mar. 04, 2011   | Mar. 03, 2012    |
| MITEQ Preamplifier         | AMF-6F-260400-33-8P      | 892164      | Mar. 04, 2011   | Mar. 03, 2012    |
| Schwarzbeck Horn Antenna   | BBHA-9170                | BBHA9170190 | Oct. 07, 2011   | Oct. 06, 2012    |
| Schwarzbeck Horn Antenna   | BBHA-9120-D1             | D130        | May 16, 2011    | May 15, 2012     |
| ADT. Turn Table            | TT100                    | 0306        | NA              | NA               |
| ADT. Tower                 | AT100                    | 0306        | NA              | NA               |
| Software                   | ADT_Radiated_V7.6.15.9.2 | NA          | NA              | NA               |
| SUHNER RF cable            | SF102                    | Cable-CH6   | Aug. 19, 2011   | Aug. 18, 2012    |

- NOTE:**
1. The calibration interval of the above test instruments is 12 months. And the calibrations are traceable to NML/ROC and NIST/USA.
  2. The test was performed in Chamber No. 6.
  3. The Industry Canada Reference No. IC 7450E-6.
  4. The VCCI Site Registration No. G-257
  5. The FCC Site Registration No. 447212.

### 4.3.3 TEST PROCEDURE

#### <Frequency Range 30MHz ~ 1GHz>

- a. The EUT was placed on the top of a rotating table 0.8 meters above the ground at a 10 meter open area test site. The table was rotated 360 degrees to determine the position of the highest radiation.
- b. The EUT was set 10 meters away from the interference-receiving antenna, which was mounted on the top of a variable-height antenna tower.
- c. The height of antenna is varied from one meter to four meters above the ground to determine the maximum value of the field strength. Both horizontal and vertical polarizations of the antenna are set to make the measurement.
- d. For each suspected emission, the EUT was arranged to its worst case and then the antenna was tuned to heights from 1 meter to 4 meters and the turn table was turned from 0 degrees to 360 degrees to find the maximum reading.
- e. The test-receiver system was set to quasi-peak detect function and specified bandwidth with maximum hold mode when the test frequency is below 1 GHz.

**NOTE:** The resolution bandwidth of test receiver/spectrum analyzer is 120kHz for Quasi-peak detection (QP) at frequency below 1GHz.

### <Frequency Range above 1GHz>

- a. The EUT was placed on the top of a rotating table 0.8 meters above the ground at a 3 meter Semi-anechoic chamber room. The table was rotated 360 degrees to determine the position of the highest radiation.
- b. The EUT was set 3 meters away from the interference-receiving antenna, which was mounted on the top of a variable-height antenna tower.
- c. The height of antenna can be varied from one meter-to four meters, the height of adjustment depends on the EUT height and the antenna 3dB beamwidth both, to detect the maximum value of the field strength. Both horizontal and vertical polarizations of the antenna are set to make the measurement.
- d. For each suspected emission, the EUT was arranged to its worst case and then the antenna was tuned to heights and the rotatable table was turned from 0 degrees to 360 degrees to find the maximum reading.
- e. The test-receiver system was set to peak and average detect function and specified bandwidth with maximum hold mode when the test frequency is above 1 GHz.

**NOTE:**

1. The resolution bandwidth is 1MHz and video bandwidth of test receiver/spectrum analyzer is 3MHz for Peak detection at frequency above 1GHz. The resolution bandwidth of test receiver/spectrum analyzer is 1 MHz for Average detection (AV) at frequency above 1GHz.
2. For measurement of frequency above 1000 MHz, the EUT was set 3 meters away from the receiver antenna.

### 4.3.4 DEVIATION FROM TEST STANDARD

No deviation

### 4.3.5 TEST SETUP

<Frequency Range 30MHz ~ 1GHz >

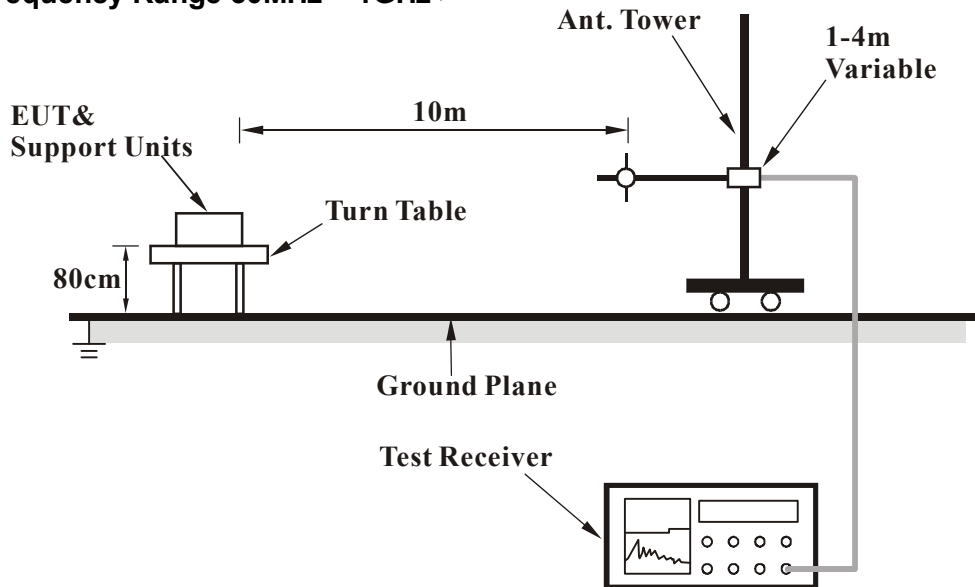

<Frequency Range above 1GHz>

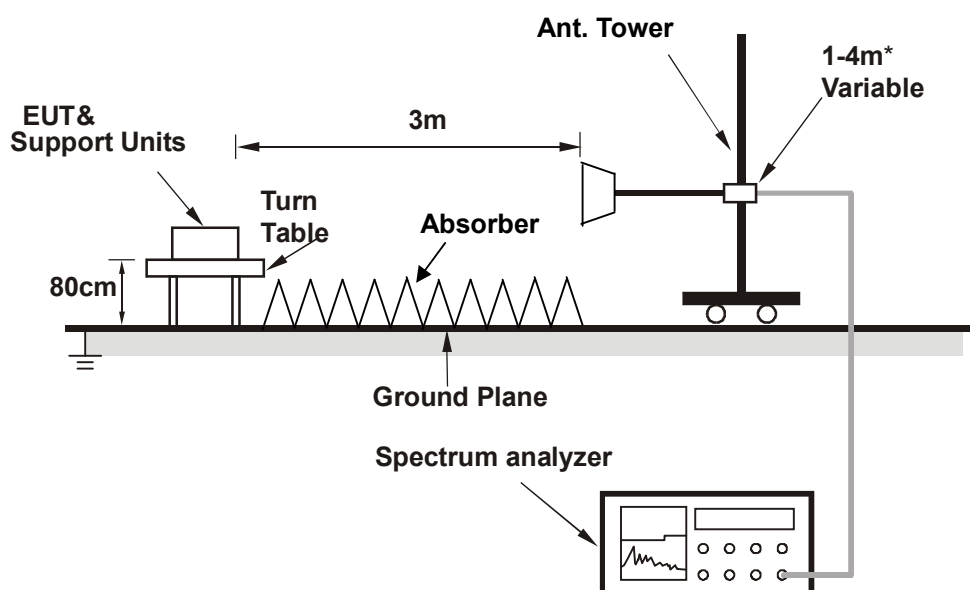

\* : depends on the EUT height and the antenna 3dB beamwidth both, refer to section 7.3 of CISPR 16-2-3.

For the actual test configuration, please refer to the related item – Photographs of the Test Configuration.

#### 4.3.6 EUT OPERATING CONDITIONS

- a. Connected the EUT with adapter or POE switch hub (kept in a remote area).
- b. Turned on the power of all equipment.
- c. EUT captured video signal.
- d. EUT sent and received messages from/to Server PC (kept in a remote area) via an UTP LAN cable (10 m). **(For Mode 1 only)**
- e. EUT sent and received messages from/to Server PC (kept in a remote area) via POE switch hub with an UTP LAN cable (10 m). **(For Mode 2 only)**
- f. EUT sent 1kHz audio signal to earphone.
- g. Steps c-g were repeated.



### 4.3.7 TEST RESULTS (1)

|                                 |                  |  |                     |
|---------------------------------|------------------|--|---------------------|
| <b>TEST MODE</b>                | Mode 1           | <b>FREQUENCY RANGE</b>                   | 30-1000 MHz         |
| <b>INPUT POWER (AC ADAPTER)</b> | 24Vac            | <b>DETECTOR FUNCTION &amp; BANDWIDTH</b> | Quasi-Peak, 120 kHz |
| <b>ENVIRONMENTAL CONDITIONS</b> | 13deg. C, 74% RH | <b>TESTED BY:</b> Paul Chen              |                     |

| ANTENNA POLARITY & TEST DISTANCE: HORIZONTAL AT 10 M |               |                         |                |              |                    |                      |                  |                          |
|--|---------------|-------------------------|----------------|--------------|--------------------|----------------------|------------------|--------------------------|
| No.  | Freq. (MHz)   | Emission Level (dBuV/m) | Limit (dBuV/m) | Margin (dB)  | Antenna Height (m) | Table Angle (Degree) | Raw Value (dBuV) | Correction Factor (dB/m) |
| 1  | 95.35         | 23.20 QP                | 30.00          | -6.80        | 4.00 H             | 138                  | 12.33            | 10.87                    |
| 2  | 125.00        | 21.24 QP                | 30.00          | -8.76        | 4.00 H             | 88                   | 7.69             | 13.55                    |
| 3  | 145.44        | 21.16 QP                | 30.00          | -8.84        | 4.00 H             | 217                  | 8.03             | 13.13                    |
| 4  | 186.16        | 22.44 QP                | 30.00          | -7.56        | 4.00 H             | 104                  | 11.35            | 11.09                    |
| 5  | 216.08        | 21.38 QP                | 30.00          | -8.62        | 4.00 H             | 328                  | 8.93             | 12.45                    |
| 6  | 266.69        | 33.28 QP                | 37.00          | -3.72        | 3.36 H             | 325                  | 17.71            | 15.57                    |
| 7  | 324.50        | 28.99 QP                | 37.00          | -8.01        | 2.55 H             | 180                  | 11.91            | 17.08                    |
| <b>8</b>   | <b>333.36</b> | <b>33.89 QP</b>         | <b>37.00</b>   | <b>-3.11</b> | <b>2.87 H</b>      | <b>136</b>           | <b>16.51</b>     | <b>17.38</b>             |
| 9  | 467.90        | 30.48 QP                | 37.00          | -6.52        | 1.86 H             | 284                  | 8.79             | 21.69                    |
| 10   | 533.37        | 33.49 QP                | 37.00          | -3.51        | 1.94 H             | 129                  | 9.40             | 24.09                    |
| 11   | 575.03        | 33.64 QP                | 37.00          | -3.36        | 1.94 H             | 171                  | 7.87             | 25.77                    |
| 12   | 600.50        | 33.02 QP                | 37.00          | -3.98        | 1.55 H             | 70                   | 6.26             | 26.76                    |
| 13   | 625.70        | 31.42 QP                | 37.00          | -5.58        | 1.87 H             | 168                  | 4.48             | 26.94                    |
| 14   | 874.99        | 29.91 QP                | 37.00          | -7.09        | 1.00 H             | 252                  | 0.22             | 29.69                    |
| 15   | 976.70        | 31.65 QP                | 37.00          | -5.35        | 1.00 H             | 117                  | 0.84             | 30.81                    |
| 16   | 999.99        | 31.22 QP                | 37.00          | -5.78        | 1.00 H             | 55                   | 0.23             | 30.99                    |

- REMARKS:**
1. Emission level(dBuV/m)=Raw Value(dBuV) + Correction Factor(dB/m)
  2. Correction Factor(dB/m) = Antenna Factor (dB/m) + Cable Factor (dB)
  3. The other emission levels were very low against the limit.
  4. Margin value = Emission level – Limit value.

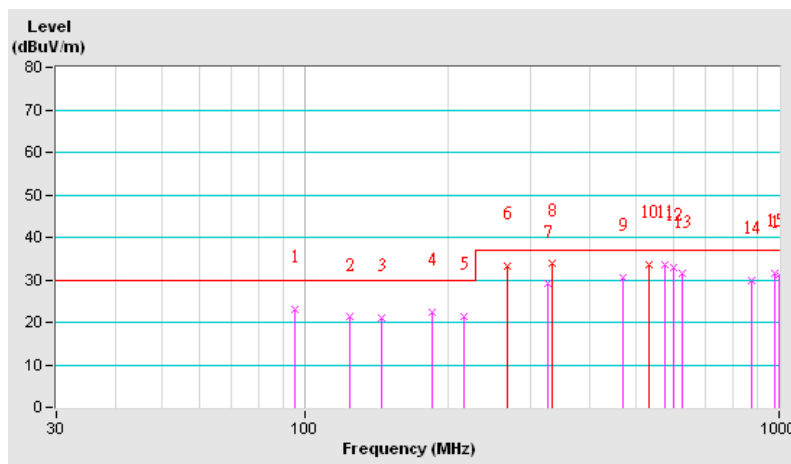



A D T

|                                 |                  |  |                     |
|---------------------------------|------------------|--|---------------------|
| <b>TEST MODE</b>                | Mode 1           | <b>FREQUENCY RANGE</b>                   | 30-1000 MHz         |
| <b>INPUT POWER (AC ADAPTER)</b> | 24Vac            | <b>DETECTOR FUNCTION &amp; BANDWIDTH</b> | Quasi-Peak, 120 kHz |
| <b>ENVIRONMENTAL CONDITIONS</b> | 13deg. C, 74% RH | <b>TESTED BY:</b> Paul Chen              |                     |

| ANTENNA POLARITY & TEST DISTANCE: VERTICAL AT 10 M |             |                         |                |             |                    |                      |                  |                          |
|--|-------------|-------------------------|----------------|-------------|--------------------|----------------------|------------------|--------------------------|
| No.  | Freq. (MHz) | Emission Level (dBuV/m) | Limit (dBuV/m) | Margin (dB) | Antenna Height (m) | Table Angle (Degree) | Raw Value (dBuV) | Correction Factor (dB/m) |
| 1  | 49.43       | 23.20 QP                | 30.00          | -6.80       | 1.00 V             | 265                  | 12.30            | 10.90                    |
| 2  | 95.63       | 26.73 QP                | 30.00          | -3.27       | 1.00 V             | 0                    | 15.82            | 10.91                    |
| 3  | 125.01      | 21.47 QP                | 30.00          | -8.53       | 1.00 V             | 242                  | 7.92             | 13.55                    |
| 4  | 142.00      | 23.90 QP                | 30.00          | -6.10       | 1.00 V             | 50                   | 10.66            | 13.24                    |
| 5  | 198.16      | 26.38 QP                | 30.00          | -3.62       | 1.00 V             | 300                  | 15.25            | 11.13                    |
| 6  | 225.03      | 22.54 QP                | 30.00          | -7.46       | 1.00 V             | 199                  | 9.35             | 13.19                    |
| 7  | 266.69      | 28.38 QP                | 37.00          | -8.62       | 1.00 V             | 194                  | 12.81            | 15.57                    |
| 8  | 296.50      | 28.45 QP                | 37.00          | -8.55       | 1.00 V             | 125                  | 12.27            | 16.18                    |
| 9  | 333.33      | 32.48 QP                | 37.00          | -4.52       | 1.00 V             | 269                  | 15.10            | 17.38                    |
| 10   | 400.80      | 27.55 QP                | 37.00          | -9.45       | 1.00 V             | 54                   | 7.92             | 19.63                    |
| 11   | 533.38      | 33.48 QP                | 37.00          | -3.52       | 3.21 V             | 170                  | 9.39             | 24.09                    |
| 12   | 575.03      | 33.35 QP                | 37.00          | -3.65       | 3.00 V             | 270                  | 7.58             | 25.77                    |
| 13   | 600.03      | 31.90 QP                | 37.00          | -5.10       | 3.21 V             | 50                   | 5.14             | 26.76                    |
| 14   | 625.70      | 32.41 QP                | 37.00          | -4.59       | 3.08 V             | 286                  | 5.47             | 26.94                    |
| 15   | 875.04      | 31.43 QP                | 37.00          | -5.57       | 1.97 V             | 93                   | 1.74             | 29.69                    |
| 16   | 999.99      | 31.12 QP                | 37.00          | -5.88       | 1.97 V             | 330                  | 0.13             | 30.99                    |

- REMARKS:**
1. Emission level(dBuV/m)=Raw Value(dBuV) + Correction Factor(dB/m)
  2. Correction Factor(dB/m) = Antenna Factor (dB/m) + Cable Factor (dB)
  3. The other emission levels were very low against the limit.
  4. Margin value = Emission level – Limit value.

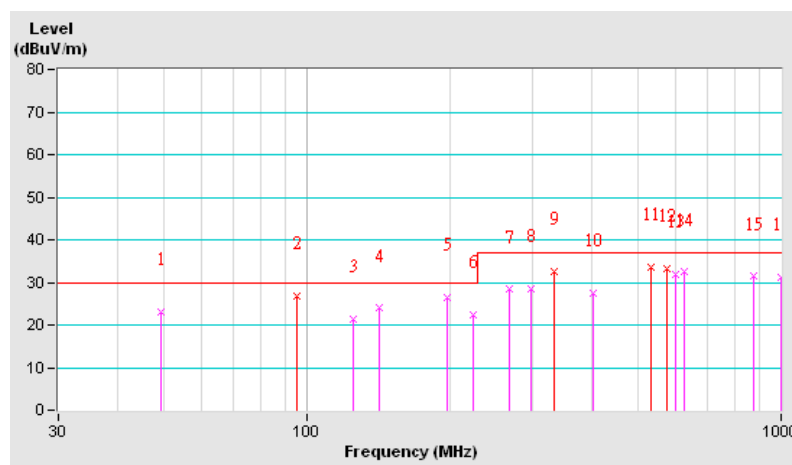



A D T

|                                 |                  |  |                     |
|---------------------------------|------------------|--|---------------------|
| <b>TEST MODE</b>                | Mode 1           | <b>FREQUENCY RANGE</b>                   | 1-2GHz              |
| <b>INPUT POWER (AC ADAPTER)</b> | 24Vac            | <b>DETECTOR FUNCTION &amp; BANDWIDTH</b> | Peak/ Average, 1MHz |
| <b>ENVIRONMENTAL CONDITIONS</b> | 18deg. C, 71% RH | <b>TESTED BY:</b> Nick Chen              |                     |

**ANTENNA POLARITY & TEST DISTANCE: HORIZONTAL AT 3 M**

| No. | Freq. (MHz) | Emission Level (dBuV/m) | Limit (dBuV/m) | Margin (dB) | Antenna Height (m) | Table Angle (Degree) | Raw Value (dBuV) | Correction Factor (dB/m) |
|-----|-------------|-------------------------|----------------|-------------|--------------------|----------------------|------------------|--------------------------|
| 1   | 1084.19     | 45.12 PK                | 70.00          | -24.88      | 1.03 H             | 162                  | 19.05            | 26.07                    |
| 2   | 1084.19     | 34.71 AV                | 50.00          | -15.29      | 1.03 H             | 162                  | 8.64             | 26.07                    |
| 3   | 1332.51     | 47.26 PK                | 70.00          | -22.74      | 1.02 H             | 54                   | 20.23            | 27.03                    |
| 4   | 1332.51     | 35.18 AV                | 50.00          | -14.82      | 1.02 H             | 54                   | 8.15             | 27.03                    |
| 5   | 1867.21     | 45.33 PK                | 70.00          | -24.67      | 1.00 H             | 159                  | 16.96            | 28.37                    |
| 6   | 1867.21     | 34.97 AV                | 50.00          | -15.03      | 1.00 H             | 159                  | 6.60             | 28.37                    |

- REMARKS:**
1. Emission level(dBuV/m)=Raw Value(dBuV) + Correction Factor(dB/m)
  2. Correction Factor(dB/m) = Antenna Factor (dB/m) + Cable Factor (dB)
  3. The other emission levels were very low against the limit.
  4. Margin value = Emission level – Limit value.

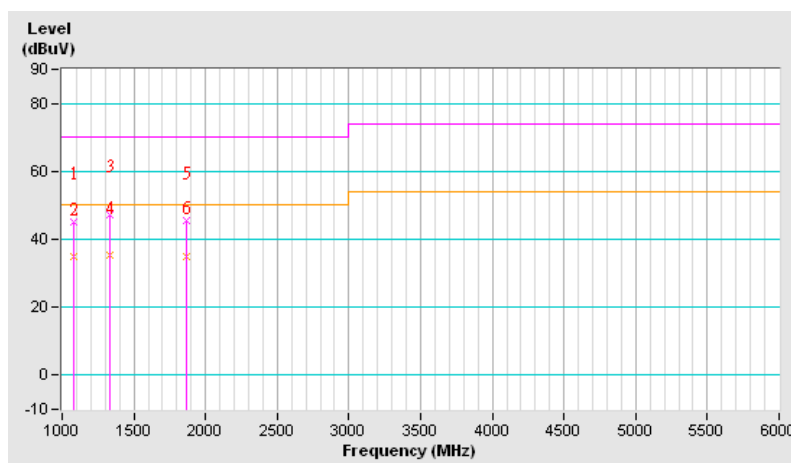

|                                 |                  |  |                     |
|---------------------------------|------------------|--|---------------------|
| <b>TEST MODE</b>                | Mode 1           | <b>FREQUENCY RANGE</b>                   | 1-2GHz              |
| <b>INPUT POWER (AC ADAPTER)</b> | 24Vac            | <b>DETECTOR FUNCTION &amp; BANDWIDTH</b> | Peak/ Average, 1MHz |
| <b>ENVIRONMENTAL CONDITIONS</b> | 18deg. C, 71% RH | <b>TESTED BY:</b> Nick Chen              |                     |

| <b>ANTENNA POLARITY &amp; TEST DISTANCE: VERTICAL AT 3 M</b> |             |                         |                |             |                    |                      |                  |                          |
|--|-------------|-------------------------|----------------|-------------|--------------------|----------------------|------------------|--------------------------|
| No.  | Freq. (MHz) | Emission Level (dBuV/m) | Limit (dBuV/m) | Margin (dB) | Antenna Height (m) | Table Angle (Degree) | Raw Value (dBuV) | Correction Factor (dB/m) |
| 1  | 1067.21     | 47.21 PK                | 70.00          | -22.79      | 1.02 V             | 227                  | 21.19            | 26.02                    |
| 2  | 1067.21     | 33.59 AV                | 50.00          | -16.41      | 1.02 V             | 227                  | 7.57             | 26.02                    |
| 3  | 1559.34     | 45.26 PK                | 70.00          | -24.74      | 1.05 V             | 198                  | 17.53            | 27.73                    |
| 4  | 1559.34     | 34.19 AV                | 50.00          | -15.81      | 1.05 V             | 198                  | 6.46             | 27.73                    |
| 5  | 1867.24     | 46.21 PK                | 70.00          | -23.79      | 1.16 V             | 214                  | 17.84            | 28.37                    |
| 6  | 1867.24     | 34.32 AV                | 50.00          | -15.68      | 1.16 V             | 214                  | 5.95             | 28.37                    |

- REMARKS:**
1. Emission level(dBuV/m)=Raw Value(dBuV) + Correction Factor(dB/m)
  2. Correction Factor(dB/m) = Antenna Factor (dB/m) + Cable Factor (dB)
  3. The other emission levels were very low against the limit.
  4. Margin value = Emission level – Limit value.

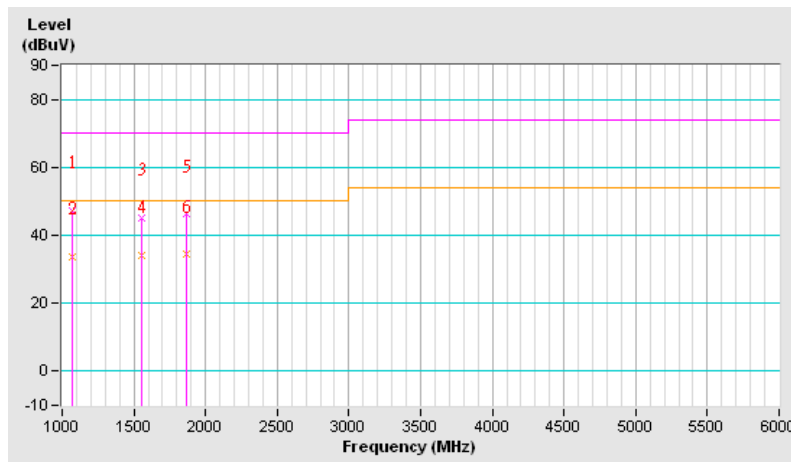

### 4.3.8 TEST RESULTS (2)

|                                 |                  |  |                     |
|---------------------------------|------------------|--|---------------------|
| <b>TEST MODE</b>                | Mode 2           | <b>FREQUENCY RANGE</b>                   | 30-1000 MHz         |
| <b>INPUT POWER (POE)</b>        | 48Vdc            | <b>DETECTOR FUNCTION &amp; BANDWIDTH</b> | Quasi-Peak, 120 kHz |
| <b>ENVIRONMENTAL CONDITIONS</b> | 13deg. C, 74% RH | <b>TESTED BY:</b> Paul Chen              |                     |

#### ANTENNA POLARITY & TEST DISTANCE: HORIZONTAL AT 10 M

| No. | Freq. (MHz) | Emission Level (dBuV/m) | Limit (dBuV/m) | Margin (dB) | Antenna Height (m) | Table Angle (Degree) | Raw Value (dBuV) | Correction Factor (dB/m) |
|-----|-------------|-------------------------|----------------|-------------|--------------------|----------------------|------------------|--------------------------|
| 1   | 124.98      | 23.63 QP                | 30.00          | -6.37       | 4.00 H             | 358                  | 10.08            | 13.55                    |
| 2   | 137.24      | 26.50 QP                | 30.00          | -3.50       | 4.00 H             | 0                    | 13.15            | 13.35                    |
| 3   | 165.44      | 22.63 QP                | 30.00          | -7.37       | 4.00 H             | 229                  | 10.53            | 12.10                    |
| 4   | 186.32      | 20.97 QP                | 30.00          | -9.03       | 4.00 H             | 253                  | 9.88             | 11.09                    |
| 5   | 216.16      | 21.06 QP                | 30.00          | -8.94       | 4.00 H             | 291                  | 8.60             | 12.46                    |
| 6   | 266.69      | 33.37 QP                | 37.00          | -3.63       | 3.32 H             | 135                  | 17.80            | 15.57                    |
| 7   | 270.01      | 33.55 QP                | 37.00          | -3.45       | 3.32 H             | 80                   | 17.91            | 15.64                    |
| 8   | 333.34      | 32.00 QP                | 37.00          | -5.00       | 2.67 H             | 11                   | 14.62            | 17.38                    |
| 9   | 475.02      | 32.43 QP                | 37.00          | -4.57       | 2.12 H             | 213                  | 10.51            | 21.92                    |
| 10  | 525.04      | 33.87 QP                | 37.00          | -3.13       | 2.07 H             | 224                  | 10.13            | 23.74                    |
| 11  | 533.38      | 33.69 QP                | 37.00          | -3.31       | 2.07 H             | 224                  | 9.60             | 24.09                    |
| 12  | 601.30      | 29.30 QP                | 37.00          | -7.70       | 1.95 H             | 199                  | 2.54             | 26.76                    |
| 13  | 666.80      | 29.10 QP                | 37.00          | -7.90       | 1.44 H             | 258                  | 1.89             | 27.21                    |
| 14  | 875.03      | 30.41 QP                | 37.00          | -6.59       | 1.00 H             | 144                  | 0.72             | 29.69                    |
| 15  | 975.04      | 31.17 QP                | 37.00          | -5.83       | 1.00 H             | 26                   | 0.37             | 30.80                    |
| 16  | 999.99      | 31.37 QP                | 37.00          | -5.63       | 1.00 H             | 344                  | 0.38             | 30.99                    |

- REMARKS:**
1. Emission level(dBuV/m)=Raw Value(dBuV) + Correction Factor(dB/m)
  2. Correction Factor(dB/m) = Antenna Factor (dB/m) + Cable Factor (dB)
  3. The other emission levels were very low against the limit.
  4. Margin value = Emission level – Limit value.

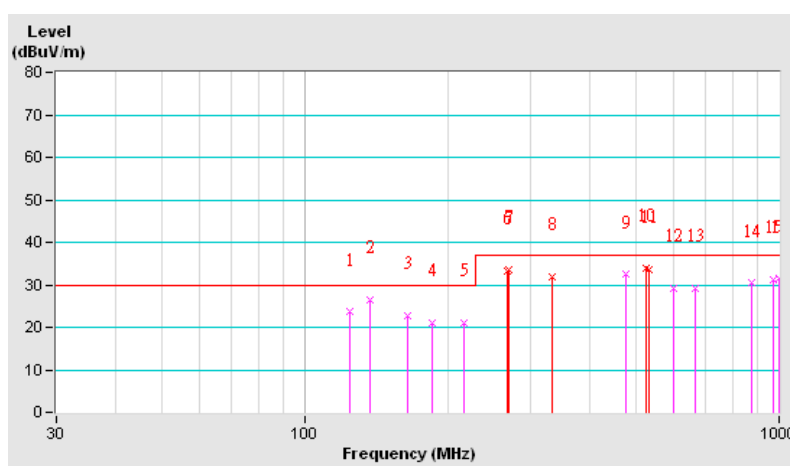



|                                 |                  |  |                     |
|---------------------------------|------------------|--|---------------------|
| <b>TEST MODE</b>                | Mode 2           | <b>FREQUENCY RANGE</b>                   | 30-1000 MHz         |
| <b>INPUT POWER (POE)</b>        | 48Vdc            | <b>DETECTOR FUNCTION &amp; BANDWIDTH</b> | Quasi-Peak, 120 kHz |
| <b>ENVIRONMENTAL CONDITIONS</b> | 13deg. C, 74% RH | <b>TESTED BY:</b> Paul Chen              |                     |

**ANTENNA POLARITY & TEST DISTANCE: VERTICAL AT 10 M**

| No. | Freq. (MHz) | Emission Level (dBuV/m) | Limit (dBuV/m) | Margin (dB) | Antenna Height (m) | Table Angle (Degree) | Raw Value (dBuV) | Correction Factor (dB/m) |
|-----|-------------|-------------------------|----------------|-------------|--------------------|----------------------|------------------|--------------------------|
| 1   | 125.01      | 23.99 QP                | 30.00          | -6.01       | 1.00 V             | 279                  | 10.44            | 13.55                    |
| 2   | 133.34      | 24.88 QP                | 30.00          | -5.12       | 1.00 V             | 82                   | 11.47            | 13.41                    |
| 3   | 147.78      | 24.92 QP                | 30.00          | -5.08       | 1.00 V             | 120                  | 11.87            | 13.05                    |
| 4   | 198.12      | 24.86 QP                | 30.00          | -5.14       | 1.00 V             | 146                  | 13.73            | 11.13                    |
| 5   | 216.02      | 22.43 QP                | 30.00          | -7.57       | 1.00 V             | 240                  | 9.98             | 12.45                    |
| 6   | 249.30      | 27.44 QP                | 37.00          | -9.56       | 1.00 V             | 19                   | 12.26            | 15.18                    |
| 7   | 266.69      | 32.85 QP                | 37.00          | -4.15       | 1.00 V             | 262                  | 17.28            | 15.57                    |
| 8   | 333.37      | 32.85 QP                | 37.00          | -4.15       | 1.00 V             | 145                  | 15.47            | 17.38                    |
| 9   | 400.03      | 29.74 QP                | 37.00          | -7.26       | 1.00 V             | 158                  | 10.13            | 19.61                    |
| 10  | 466.75      | 30.26 QP                | 37.00          | -6.74       | 3.25 V             | 289                  | 8.60             | 21.66                    |
| 11  | 525.02      | 33.85 QP                | 37.00          | -3.15       | 2.55 V             | 302                  | 10.11            | 23.74                    |
| 12  | 533.38      | 33.30 QP                | 37.00          | -3.70       | 2.99 V             | 344                  | 9.21             | 24.09                    |
| 13  | 600.03      | 29.25 QP                | 37.00          | -7.75       | 3.03 V             | 266                  | 2.49             | 26.76                    |
| 14  | 875.04      | 30.56 QP                | 37.00          | -6.44       | 1.92 V             | 213                  | 0.87             | 29.69                    |
| 15  | 933.39      | 33.47 QP                | 37.00          | -3.53       | 1.92 V             | 33                   | 2.99             | 30.48                    |
| 16  | 999.99      | 31.27 QP                | 37.00          | -5.73       | 1.99 V             | 86                   | 0.28             | 30.99                    |

- REMARKS:**
1. Emission level(dBuV/m)=Raw Value(dBuV) + Correction Factor(dB/m)
  2. Correction Factor(dB/m) = Antenna Factor (dB/m) + Cable Factor (dB)
  3. The other emission levels were very low against the limit.
  4. Margin value = Emission level – Limit value.

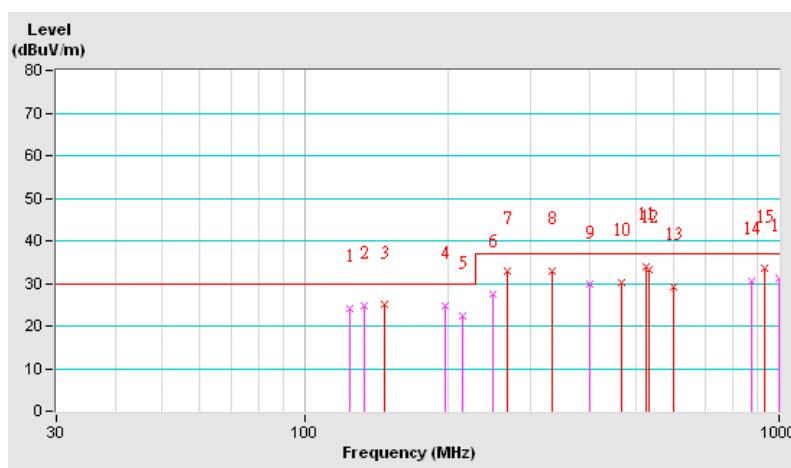

|                                 |                  |  |                     |
|---------------------------------|------------------|--|---------------------|
| <b>TEST MODE</b>                | Mode 2           | <b>FREQUENCY RANGE</b>                   | 1-2GHz              |
| <b>INPUT POWER (POE)</b>        | 48Vdc            | <b>DETECTOR FUNCTION &amp; BANDWIDTH</b> | Peak/ Average, 1MHz |
| <b>ENVIRONMENTAL CONDITIONS</b> | 18deg. C, 71% RH | <b>TESTED BY:</b> Nick Chen              |                     |

**ANTENNA POLARITY & TEST DISTANCE: HORIZONTAL AT 3 M**

| No. | Freq. (MHz) | Emission Level (dBuV/m) | Limit (dBuV/m) | Margin (dB) | Antenna Height (m) | Table Angle (Degree) | Raw Value (dBuV) | Correction Factor (dB/m) |
|-----|-------------|-------------------------|----------------|-------------|--------------------|----------------------|------------------|--------------------------|
| 1   | 1075.39     | 44.72 PK                | 70.00          | -25.28      | 1.00 H             | 26                   | 18.67            | 26.05                    |
| 2   | 1075.39     | 33.18 AV                | 50.00          | -16.82      | 1.00 H             | 26                   | 7.13             | 26.05                    |
| 3   | 1332.41     | 43.91 PK                | 70.00          | -26.09      | 1.00 H             | 176                  | 16.88            | 27.03                    |
| 4   | 1332.41     | 33.98 AV                | 50.00          | -16.02      | 1.00 H             | 176                  | 6.95             | 27.03                    |
| 5   | 1794.55     | 44.52 PK                | 70.00          | -25.48      | 1.00 H             | 85                   | 16.26            | 28.26                    |
| 6   | 1794.55     | 34.08 AV                | 50.00          | -15.92      | 1.00 H             | 85                   | 5.82             | 28.26                    |

- REMARKS:**
1. Emission level(dBuV/m)=Raw Value(dBuV) + Correction Factor(dB/m)
  2. Correction Factor(dB/m) = Antenna Factor (dB/m) + Cable Factor (dB)
  3. The other emission levels were very low against the limit.
  4. Margin value = Emission level – Limit value.

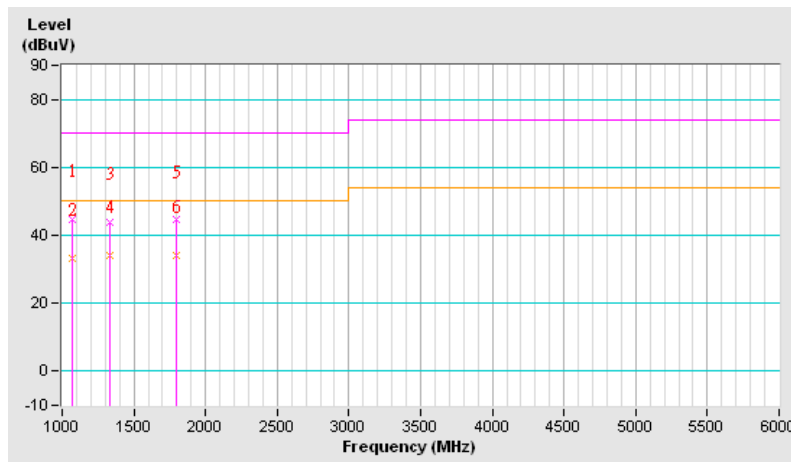

|                                 |                  |  |                     |
|---------------------------------|------------------|--|---------------------|
| <b>TEST MODE</b>                | Mode 2           | <b>FREQUENCY RANGE</b>                   | 1-2GHz              |
| <b>INPUT POWER (POE)</b>        | 48Vdc            | <b>DETECTOR FUNCTION &amp; BANDWIDTH</b> | Peak/ Average, 1MHz |
| <b>ENVIRONMENTAL CONDITIONS</b> | 18deg. C, 71% RH | <b>TESTED BY:</b> Nick Chen              |                     |

| <b>ANTENNA POLARITY &amp; TEST DISTANCE: VERTICAL AT 3 M</b> |             |                         |                |             |                    |                      |                  |                          |
|--|-------------|-------------------------|----------------|-------------|--------------------|----------------------|------------------|--------------------------|
| No.  | Freq. (MHz) | Emission Level (dBuV/m) | Limit (dBuV/m) | Margin (dB) | Antenna Height (m) | Table Angle (Degree) | Raw Value (dBuV) | Correction Factor (dB/m) |
| 1  | 1072.51     | 44.81 PK                | 70.00          | -25.19      | 1.07 V             | 228                  | 18.77            | 26.04                    |
| 2  | 1072.51     | 34.19 AV                | 50.00          | -15.81      | 1.07 V             | 228                  | 8.15             | 26.04                    |
| 3  | 1334.96     | 45.18 PK                | 70.00          | -24.82      | 1.14 V             | 209                  | 18.14            | 27.04                    |
| 4  | 1334.96     | 35.18 AV                | 50.00          | -14.82      | 1.14 V             | 209                  | 8.14             | 27.04                    |
| 5  | 1868.15     | 45.11 PK                | 70.00          | -24.89      | 1.00 V             | 65                   | 16.74            | 28.37                    |
| 6  | 1868.15     | 34.84 AV                | 50.00          | -15.16      | 1.00 V             | 65                   | 6.47             | 28.37                    |

- REMARKS:**
1. Emission level(dBuV/m)=Raw Value(dBuV) + Correction Factor(dB/m)
  2. Correction Factor(dB/m) = Antenna Factor (dB/m) + Cable Factor (dB)
  3. The other emission levels were very low against the limit.
  4. Margin value = Emission level – Limit value.

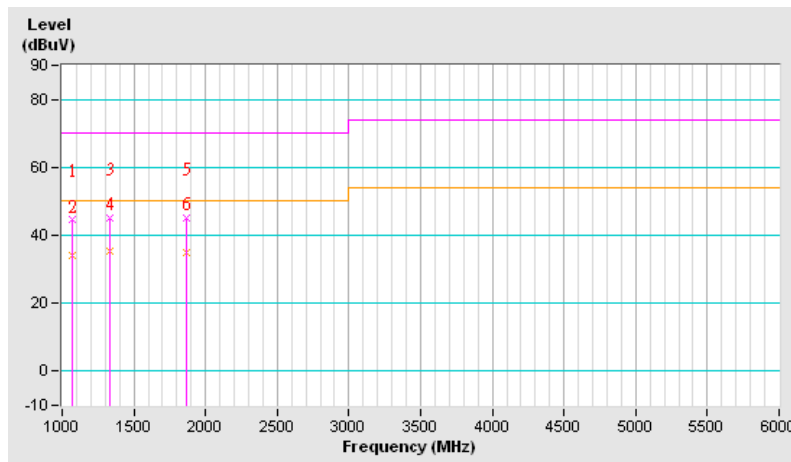



## 5 IMMUNITY TEST

### 5.1 GENERAL DESCRIPTION

|   |                      |   |
|---|----------------------|---|
| <b>Product Standard:</b>  | <b>EN 55024:2010</b> |   |
| <b>Basic Standard, specification requirement, and Performance Criteria:</b> | IEC 61000-4-2        | Electrostatic Discharge – ESD:<br>8kV air discharge,<br>4kV Contact discharge,<br>Performance Criterion B   |
|   | IEC 61000-4-3        | Radio-Frequency Electromagnetic Field Susceptibility Test – RS:<br>80-1000 MHz, 3V/m, 80% AM (1kHz),<br>Performance Criterion A   |
|   | IEC 61000-4-4        | Electrical Fast Transient/Burst - EFT<br>AC Power line: 1kV,<br>DC Power line: 0.5kV<br>Signal line: 0.5kV<br>Performance Criterion B   |
|   | IEC 61000-4-5        | Surge Immunity Test:<br>1.2/50 us Open Circuit Voltage, 8 /20 us Short Circuit Current,<br>AC Power Line: line to line 1 kV,<br>line to earth 2kV<br>DC Power Line: line to earth 0.5kV<br>Performance Criterion B<br>Signal line:<br>i) 1 kV without primary protectors,<br>Performance Criteria C<br>ii) 4 kV with primary protectors,<br>Performance Criterion C |
|   | IEC 61000-4-6        | Conducted Radio Frequency Disturbances Test – CS:<br>0.15-80 MHz, 3Vrms, 80% AM, 1kHz,<br>Performance Criterion A   |
|   | IEC 61000-4-8        | Power Frequency Magnetic Field Test,<br>50 Hz, 1A/m,<br>Performance Criterion A   |

## 5.2 GENERAL PERFORMANCE CRITERIA DESCRIPTION

According to Clause 7.1 of EN 55024:2010 standard, the following describes the general performance criteria.

|                    |  |
|--------------------|--|
| <b>CRITERION A</b> | The equipment shall continue to operate as intended without operator intervention. No degradation of performance or loss of function is allowed below a performance level specified by the manufacturer when the equipment is used as intended. The performance level may be replaced by a permissible loss of performance. If the minimum performance level or the permissible performance loss is not specified by the manufacturer, then either of these may be derived from the product description and documentation, and by what the user may reasonably expect from the equipment if used as intended.  |
| <b>CRITERION B</b> | <p>After the test, the equipment shall continue to operate as intended without operator intervention. No degradation of performance or loss of function is allowed, after the application of the phenomenon below a performance level specified by the manufacturer, when the equipment is used as intended. The performance level may be replaced by a permissible loss of performance.</p> <p>During the test, degradation of performance is allowed. However, no change of operating state if stored data is allowed to persist after the test. If the minimum performance level (or the permissible performance loss) is not specified by the manufacturer, then either of these may be derived from the product description and documentation, and by what the user may reasonably expect from the equipment if used as intended.</p> |
| <b>CRITERION C</b> | <p>Loss of function is allowed, provided the function is self-recoverable, or can be restored by the operation of the controls by the user in accordance with the manufacturer's instructions.</p> <p>Functions, and/or information stored in non-volatile memory, or protected by a battery backup, shall not be lost.</p>  |

### **5.3 EUT OPERATING CONDITION**

- a. Connected the EUT with adapter and POE switch hub.
- b. Turned on the power of all equipment.
- c. EUT captured video signal.
- d. EUT sent and received messages from/to Server PC (kept in a remote area) via POE switch hub with an UTP LAN cable (10 m).
- e. EUT sent 1kHz audio signal to earphone.
- f. Steps c-f were repeated.

## 5.4 ELECTROSTATIC DISCHARGE IMMUNITY TEST (ESD)

### 5.4.1 TEST SPECIFICATION

|                             |   |
|-----------------------------|---|
| <b>Basic Standard:</b>      | IEC 61000-4-2   |
| <b>Discharge Impedance:</b> | 330 ohm / 150 pF  |
| <b>Discharge Voltage:</b>   | Air Discharge : 2, 4, 8kV (Direct)<br>Contact Discharge : 2, 4kV (Indirect)                   |
| <b>Polarity:</b>            | Positive & Negative   |
| <b>Number of Discharge:</b> | Air Discharge: Min. 20 times at each test point<br>Contact Discharge: Min. 200 times in total |
| <b>Discharge Mode:</b>      | Single Discharge  |
| <b>Discharge Period:</b>    | 1 second minimum  |

### 5.4.2 TEST INSTRUMENTS

| DESCRIPTION & MANUFACTURER | MODEL NO. | SERIAL NO. | CALIBRATED DATE | CALIBRATED UNTIL |
|----------------------------|-----------|------------|-----------------|------------------|
| KeyTek,<br>ESD Simulator   | MZ-15/EC  | 0504259    | May 30, 2011    | May 29, 2012     |

- NOTE:** 1. The test was performed in ESD Room No. 1.  
2. The calibration interval of the above test instruments is 12 months and the calibrations are traceable to NML/ROC and NIST/USA.

### 5.4.3 TEST PROCEDURE

The discharges shall be applied in two ways:

- a. Contact discharges to the conductive surfaces and coupling planes:  
The EUT shall be exposed to at least 200 discharges, 100 each at negative and positive polarity, at a minimum of four test points. One of the test points shall be subjected to at least 50 indirect discharges to the center of the front edge of the horizontal coupling plane. The remaining three test points shall each receive at least 50 direct contact discharges. If no direct contact test points are available, then at least 200 indirect discharges shall be applied in the indirect mode. Test shall be performed at a maximum repetition rate of one discharge per second.
- b. Air discharges at slots and apertures and insulating surfaces:  
On those parts of the EUT where it is not possible to perform contact discharge testing, the equipment should be investigated to identify user accessible points where breakdown may occur. Such points are tested using the air discharge method. This investigation should be restricted to those area normally handled by the user. A minimum of 10 single air discharges shall be applied to the selected test point for each such area.

The basic test procedure was in accordance with IEC 61000-4-2:

- a. Electrostatic discharges were applied only to those points and surfaces of the EUT that are accessible to users during normal operation.
- b. The test was performed with at least ten single discharges on the pre-selected points in the most sensitive polarity.
- c. The time interval between two successive single discharges was at least 1 second.
- d. The ESD generator was held perpendicularly to the surface to which the discharge was applied and the return cable was at least 0.2 meters from the EUT.
- e. Contact discharges were applied to the non-insulating coating, with the pointed tip of the generator penetrating the coating and contacting the conducting substrate.
- f. Air discharges were applied with the round discharge tip of the discharge electrode approaching the EUT as fast as possible (without causing mechanical damage) to touch the EUT. After each discharge, the ESD generator was removed from the EUT and re-triggered for a new single discharge. The test was repeated until all discharges were complete.
- g. At least ten single discharges (in the most sensitive polarity) were applied to the **Horizontal Coupling Plane** at points on each side of the EUT. The ESD generator was positioned horizontally at a distance of 0.1 meters from the EUT with the discharge electrode touching the **HCP**.
- h. At least ten single discharges (in the most sensitive polarity) were applied to the center of one vertical edge of the **Vertical Coupling Plane** in sufficiently different positions that the four faces of the EUT were completely illuminated. The **VCP** (dimensions 0.5m x 0.5m) was placed vertically to and 0.1 meters from the EUT.

#### **5.4.4 DEVIATION FROM TEST STANDARD**

No deviation

## 5.4.5 TEST SETUP

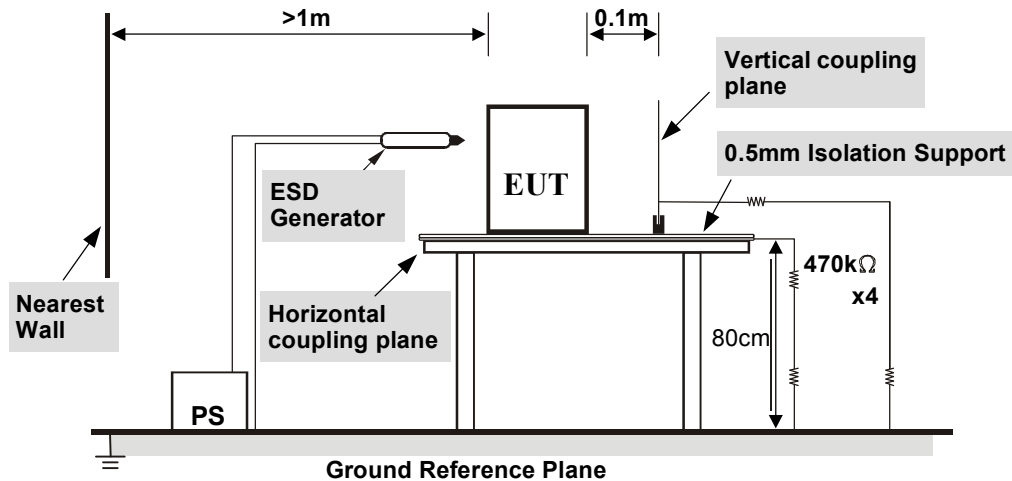

For the actual test configuration, please refer to the related item – Photographs of the Test Configuration.

### NOTE:

#### TABLE-TOP EQUIPMENT

The configuration consisted of a wooden table 0.8 meters high standing on the **Ground Reference Plane**. The **GRP** consisted of a sheet of aluminum at least 0.25mm thick, and 2.5 meters square connected to the protective grounding system. A **Horizontal Coupling Plane** (1.6m x 0.8m) was placed on the table and attached to the **GRP** by means of a cable with 940kΩ total impedance. The equipment under test, was installed in a representative system as described in section 7 of IEC 61000-4-2, and its cables were placed on the **HCP** and isolated by an insulating support of 0.5mm thickness. A distance of 1-meter minimum was provided between the EUT and the walls of the laboratory and any other metallic structure.

#### FLOOR-STANDING EQUIPMENT

The equipment under test was installed in a representative system as described in section 7 of IEC 61000-4-2, and its cables were isolated from the Ground Reference Plane by an insulating support of 0.1-meter thickness. The GRP consisted of a sheet of aluminum that is at least 0.25mm thick, and 2.5 meters square connected to the protective grounding system and extended at least 0.5 meters from the EUT on all sides.

## 5.4.6 TEST RESULTS

|                                 |                             |                                 |       |
|---------------------------------|-----------------------------|---------------------------------|-------|
| <b>TEST MODE</b>                | Mode 1                      | <b>INPUT POWER (AC ADAPTER)</b> | 24Vac |
| <b>ENVIRONMENTAL CONDITIONS</b> | 20deg. C, 48%RH,<br>1005hPa | <b>TESTED BY:</b> Ryan Chen     |       |

| <b>TEST RESULTS OF DIRECT APPLICATION</b> |          |            |                   |               |                       |
|---|----------|------------|-------------------|---------------|-----------------------|
| Discharge Level (kV)                      | Polarity | Test Point | Contact Discharge | Air Discharge | Performance Criterion |
| 2, 4, 8                                   | +/-      | 1 ~ 3      | N/A               | Note          | A                     |

**Description of test point:** Please refer to ESD test photo for representative mark only.

| <b>TEST RESULTS OF INDIRECT APPLICATION</b> |          |            |                           |                         |                       |
|---|----------|------------|---------------------------|-------------------------|-----------------------|
| Discharge Level (kV)                        | Polarity | Test Point | Horizontal Coupling Plane | Vertical Coupling Plane | Performance Criterion |
| 2, 4  | +/-      | 1 ~ 4      | Note                      | Note                    | A                     |

**Description of test point:**

1. Left side
2. Right side
3. Front side
4. Rear side

**NOTE:** There was no change compared with initial operation during the test.

## 5.5 RADIATED, RADIO-FREQUENCY, ELECTROMAGNETIC FIELD IMMUNITY TEST (RS)

### 5.5.1 TEST SPECIFICATION

|                             |                                     |
|-----------------------------|-------------------------------------|
| <b>Basic Standard:</b>      | IEC 61000-4-3                       |
| <b>Frequency Range:</b>     | 80 MHz - 1000 MHz                   |
| <b>Field Strength:</b>      | 3 V/m                               |
| <b>Modulation:</b>          | 1 kHz Sine Wave, 80%, AM Modulation |
| <b>Frequency Step:</b>      | 1 % of fundamental                  |
| <b>Polarity of Antenna:</b> | Horizontal and Vertical             |
| <b>Antenna Height:</b>      | 1.5 m                               |
| <b>Dwell Time:</b>          | 3 seconds                           |





## 5.5.2 TEST INSTRUMENTS

| DESCRIPTION & MANUFACTURER                       | MODEL NO.               | SERIAL NO.                              | CALIBRATED DATE | CALIBRATED UNTIL |
|--|-------------------------|---|-----------------|------------------|
| Agilent<br>Signal Generator                      | E8257D                  | MY48050465                              | Jun. 11, 2011   | Jun. 10, 2012    |
| PRANA<br>RF Amplifier                            | AP32DP280               | 0811-894                                | NA              | NA               |
| AR RF Amplifier                                  | 150W1000M3              | 306601                                  | NA              | NA               |
| AR RF Amplifier                                  | 35S4G8AM4               | 0326094                                 | NA              | NA               |
| AR RF Amplifier                                  | 100S1G4M3               | 0329249                                 | NA              | NA               |
| AR Controller                                    | SC1000M3                | 305910                                  | NA              | NA               |
| Radisense<br>Electric<br>Field Sensor            | CTR1001A<br>RadiSense 6 | 06D00232SN<br>O-02<br>06D00232SN<br>O39 | Jul. 15, 2011   | Jul. 14, 2012    |
| Radisense<br>Electric<br>Field Sensor            | CTR1002A                | 08D00057SN<br>O-07                      | Jun. 06, 2011   | Jun. 05, 2012    |
| BOONTON<br>RF Voltage Meter                      | 4232A                   | 10180                                   | Jun. 14, 2011   | Jun. 13, 2012    |
| BOONTON Power<br>Sensor                          | 51011-EMC               | 34152                                   | Jun. 14, 2011   | Jun. 13, 2012    |
| BOONTON Power<br>Sensor                          | 51011-EMC               | 34153                                   | Jun. 15, 2011   | Jun. 14, 2012    |
| AR<br>Log-Periodic<br>Antenna                    | AT6080                  | 0329465                                 | NA              | NA               |
| EMCO<br>BiconiLog Antenna                        | 3141                    | 1001                                    | NA              | NA               |
| AR<br>High Gain Antenna                          | AT4002A                 | 306533                                  | NA              | NA               |
| AR<br>High Gain Horn<br>Antenna                  | AT4010                  | 0329800                                 | NA              | NA               |
| CHANCE MOST<br>Full Anechoic<br>Chamber (9x5x3m) | Chance Most             | RS-002                                  | Feb. 10, 2012   | Feb. 09, 2013    |
| Software   | ADT_RS_V7.6             | NA                                      | NA              | NA               |

- NOTE:**
1. The test was performed in RS Room No.2.
  2. The calibration interval of the above test instruments is 12 months and the calibrations are traceable to NML/ROC and NIST/USA.
  3. The transmit antenna was located at a distance of 3 meters from the EUT.

### **5.5.3 TEST PROCEDURE**

The test procedure was in accordance with IEC 61000-4-3

- a. The testing was performed in a fully-anechoic chamber.
- b. The frequency range is swept from 80 MHz to 1000 MHz with the signal 80% amplitude modulated with a 1kHz sine wave.
- c. The dwell time at each frequency shall not be less than the time necessary for the EUT to be exercised and to respond, but shall in no case be less than 0,5s.
- d. The field strength level was 3V/m.
- e. The test was performed with the EUT exposed to both vertically and horizontally polarized fields on each of the four sides.

### **5.5.4 DEVIATION FROM TEST STANDARD**

No deviation

### 5.5.5 TEST SETUP

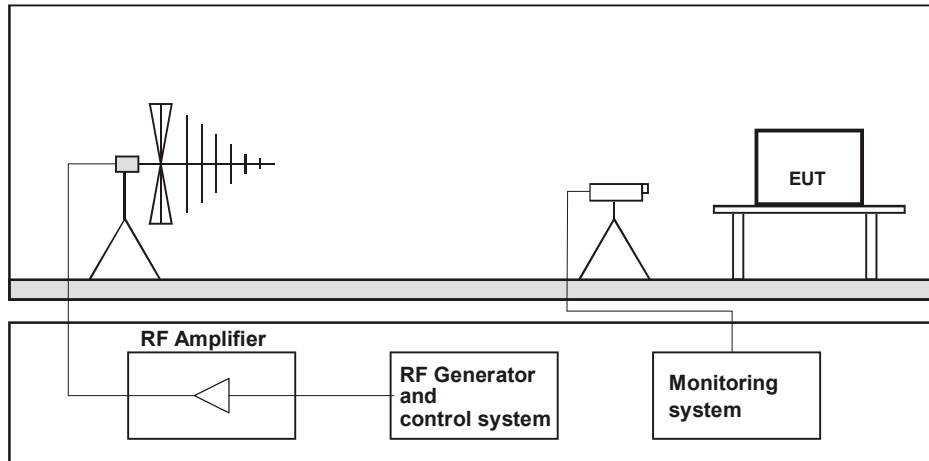

For the actual test configuration, please refer to the related item – Photographs of the Test Configuration.

**NOTE:**

TABLETOP EQUIPMENT

The EUT installed in a representative system as described in section 7 of IEC 61000-4-3 was placed on a non-conductive table 0.8 meters in height. The system under test was connected to the power and signal wire according to relevant installation instructions.

FLOOR STANDING EQUIPMENT

The EUT installed in a representative system as described in section 7 of IEC 61000-4-3 was placed on a non-conductive wood support 0.1 meters in height. The system under test was connected to the power and signal wire according to relevant installation instructions.



### 5.5.6 TEST RESULTS

|                                 |                 |                                 |       |
|---------------------------------|-----------------|---------------------------------|-------|
| <b>TEST MODE</b>                | Mode 1          | <b>INPUT POWER (AC ADAPTER)</b> | 24Vac |
| <b>ENVIRONMENTAL CONDITIONS</b> | 20deg. C, 64%RH | <b>TESTED BY:</b> Ryan Chen     |       |

| Frequency (MHz) | Polarity | Azimuth | Field Strength (V/m) | Observation | Performance Criterion |
|-----------------|----------|---------|----------------------|-------------|-----------------------|
| 80 - 1000       | V & H    | 0       | 3                    | Note        | A                     |
|                 | V & H    | 90      | 3                    |             |                       |
|                 | V & H    | 180     | 3                    |             |                       |
|                 | V & H    | 270     | 3                    |             |                       |

**NOTE:** There was no change compared with the initial operation during the test.



## 5.6 ELECTRICAL FAST TRANSIENT/BURST IMMUNITY TEST (EFT)

### 5.6.1 TEST SPECIFICATION

|                           |  |
|---------------------------|--|
| <b>Basic Standard:</b>    | IEC 61000-4-4  |
| <b>Test Voltage:</b>      | Power Line : 1 kV<br>Signal/Control Line : 0.5 kV                                    |
| <b>Polarity:</b>          | Positive & Negative  |
| <b>Impulse Frequency:</b> | 100 kHz: only for signal lines of xDSL equipment<br>5 kHz: except for xDSL equipment |
| <b>Impulse Waveshape:</b> | 5/50 ns  |
| <b>Burst Duration:</b>    | 15 ms  |
| <b>Burst Period:</b>      | 300 ms   |
| <b>Test Duration:</b>     | 1 min.   |

### 5.6.2 TEST INSTRUMENTS

| DESCRIPTION & MANUFACTURER   | MODEL NO. | SERIAL NO. | CALIBRATED DATE | CALIBRATED UNTIL |
|------------------------------|-----------|------------|-----------------|------------------|
| Haefely,<br>EFT Generator    | PEFT 4010 | 154954     | Apr. 19, 2011   | Apr. 18, 2012    |
| Haefely, Capacitive<br>Clamp | IP4A      | 155173     | NA              | NA               |

- NOTE:** 1. The test was performed in EFT Room  
2. The calibration interval of the above test instruments is 12 months and the calibrations are traceable to NML/ROC and NIST/USA.

### 5.6.3 TEST PROCEDURE

- Both positive and negative polarity discharges were applied.
- The length of the “hot wire” from the coaxial output of the EFT generator to the terminals on the EUT should not exceed 0.5 meter  $\pm$  0.05 meter.
- The duration time of each test sequential was 1 minute.
- The transient/burst waveform was in accordance with IEC 61000-4-4, 5/50ns.

### 5.6.4 DEVIATION FROM TEST STANDARD

No deviation

## 5.6.5 TEST SETUP

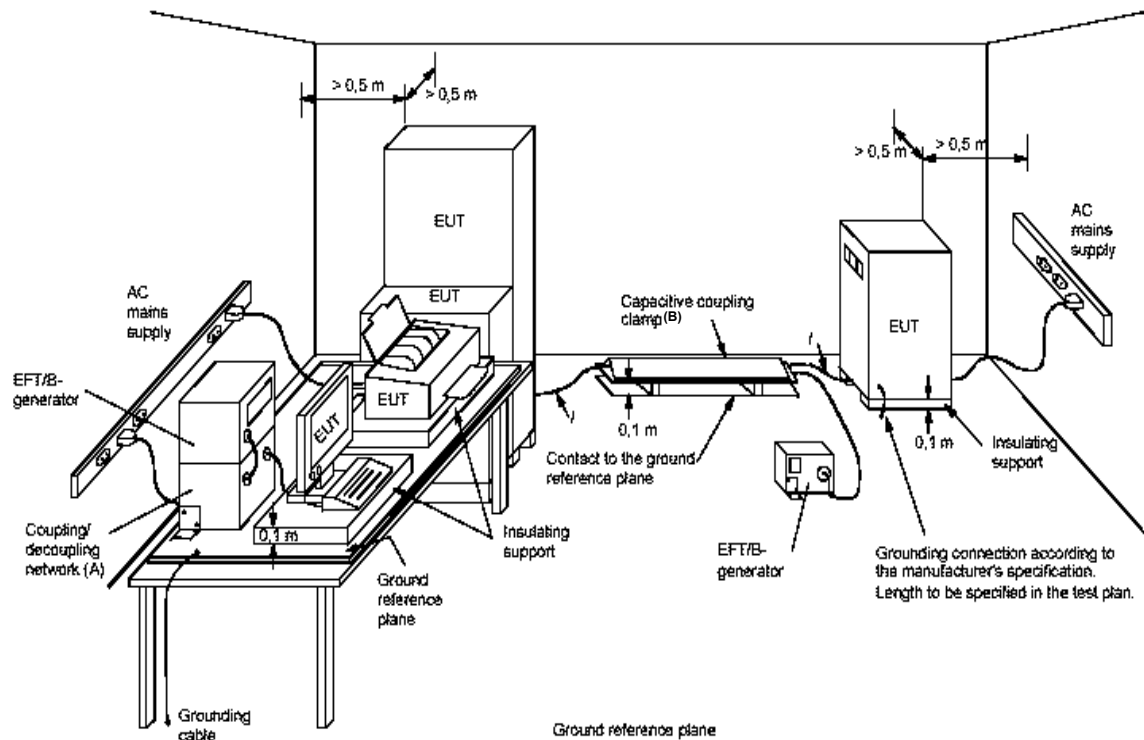

For the actual test configuration, please refer to the related item – Photographs of the Test Configuration.

*l*: length between clamp and the EUT to be tested (should be  $0.5 \pm 0.05$  m)

**(A)**: location for supply line coupling

**(B)**: location for signal lines coupling

### NOTE:

EUTs, whether stationary floor-mounted or table top, and equipment designed to be mounted in other configurations, shall be placed on a ground reference plane and shall be insulated from it by an insulating support  $0,1 \text{ m} \pm 0,01 \text{ m}$  thick. A minimum distance of 0.5m was provided between the EUT and the walls of the laboratory or any other metallic structure.

### 5.6.6 TEST RESULTS

|                                 |                 |                                 |       |
|---------------------------------|-----------------|---------------------------------|-------|
| <b>TEST MODE</b>                | Mode 1          | <b>INPUT POWER (AC ADAPTER)</b> | 24Vac |
| <b>ENVIRONMENTAL CONDITIONS</b> | 21deg. C, 64%RH | <b>TESTED BY:</b> Ryan Chen     |       |

| Test Point           | Polarity | Test Level (kV) | Observation | Performance Criterion |
|----------------------|----------|-----------------|-------------|-----------------------|
| L1                   | +/-      | 1               | Note        | A                     |
| L2                   | +/-      | 1               | Note        | A                     |
| L1-L2                | +/-      | 1               | Note        | A                     |
| Cat. 5 Line          | +/-      | 0.5             | Note        | A                     |
| Digital Line (DI/DO) | +/-      | 0.5             | Note        | A                     |

**NOTE:** There was no change compared with the initial operation during the test.

## 5.7 SURGE IMMUNITY TEST

### 5.7.1 TEST SPECIFICATION

|                               |   |
|-------------------------------|---|
| <b>Basic Standard:</b>        | IEC 61000-4-5   |
| <b>Wave-Shape:</b>            | Combination Wave for power lines<br>1.2/50 us Open Circuit Voltage<br>8 /20 us Short Circuit Current<br>10/700 us Wave for signal lines<br>10/700 us Open Circuit Voltage |
| <b>Test Voltage:</b>          | Power Line : 0.5, 1kV<br>Signal line: N/A   |
| <b>Surge Input/Output:</b>    | L1-L2   |
| <b>Generator Source</b>       | 2 ohm between networks  |
| <b>Impedance:</b>             | 12 ohm between network and ground   |
| <b>Polarity:</b>              | Positive/Negative   |
| <b>Phase Angle:</b>           | 0° /90°/180°/270°   |
| <b>Pulse Repetition Rate:</b> | 1 time / 20 sec.  |
| <b>Number of Tests:</b>       | 5 positive and 5 negative at selected points  |

### 5.7.2 TEST INSTRUMENTS

| DESCRIPTION & MANUFACTURER     | MODEL NO.        | SERIAL NO. | CALIBRATED DATE | CALIBRATED UNTIL |
|--------------------------------|------------------|------------|-----------------|------------------|
| NoiseKen<br>Surge Generator    | LSS-15AX-C3<br>A | LSS1071126 | Oct. 24, 2011   | Oct. 23, 2012    |
| Coupling<br>Decoupling Network | CDN-UTP8         | 028        | Jul. 18, 2011   | Jul. 17, 2012    |
| Surge Cable                    | WE-4             | SU1Cab-001 | NA              | NA               |
| Surge Adapter<br>WONPRO        | WA-9             | SU1ADA-002 | NA              | NA               |

- NOTE:** 1. The test was performed in Surge Room.  
2. The calibration interval of the above test instruments is 12 months and the calibrations are traceable to NML/ROC and NIST/USA.



### 5.7.3 TEST PROCEDURE

a. For EUT power supply:

The surge is to be applied to the EUT power supply terminals via the capacitive coupling network. Decoupling networks are required in order to avoid possible adverse effects on equipment not under test that may be powered by the same lines, and to provide sufficient decoupling impedance to the surge wave. The power cord between the EUT and the coupling/decoupling networks shall be 2 meters in length (or shorter).

b. For test applied to unshielded unsymmetrically operated interconnection lines of EUT:

The surge is applied to the lines via the capacitive coupling. The coupling / decoupling networks shall not influence the specified functional conditions of the EUT. The interconnection line between the EUT and the coupling/decoupling networks shall be 2 meters in length (or shorter).

c. For test applied to unshielded symmetrically operated interconnection / telecommunication lines of EUT:

The surge is applied to the lines via gas arrestors coupling. Test levels below the ignition point of the coupling arrestor cannot be specified. The interconnection line between the EUT and the coupling/decoupling networks shall be 2 meters in length (or shorter).

### 5.7.4 DEVIATION FROM TEST STANDARD

No deviation

### 5.7.5 TEST SETUP

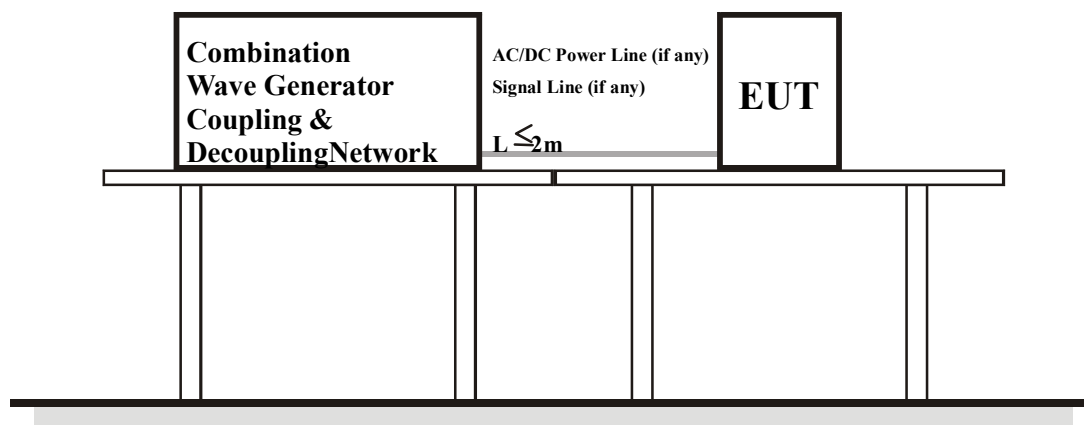

For the actual test configuration, please refer to the related item – Photographs of the Test Configuration.



## 5.7.6 TEST RESULTS

|                                     |                  |                                     |              |
|-------------------------------------|------------------|-------------------------------------|--------------|
| <b>TEST MODE</b>                    | Mode 1           | <b>INPUT POWER<br/>(AC ADAPTER)</b> | 230Vac, 50Hz |
| <b>ENVIRONMENTAL<br/>CONDITIONS</b> | 23deg. C, 62% RH | <b>TESTED BY:</b> Evan Chang        |              |

| <b>VOLTAGE<br/>(kV)</b> | <b>TEST POINT</b> | <b>POLARITY</b> | <b>OBSERVATION</b> | <b>PERFORMANCE<br/>CRITERION</b> |
|-------------------------|-------------------|-----------------|--------------------|----------------------------------|
| 0.5, 1                  | L1-L2             | +/-             | Note               | A                                |

**NOTE:** There was no change compared with the initial operation during the test.

## 5.8 IMMUNITY TO CONDUCTED DISTURBANCES INDUCED BY RF FIELDS (CS)

### 5.8.1 TEST SPECIFICATION

|                         |                                    |
|-------------------------|------------------------------------|
| <b>Basic Standard:</b>  | IEC 61000-4-6                      |
| <b>Frequency Range:</b> | 0.15 MHz - 80 MHz                  |
| <b>Field Strength:</b>  | 3 V <sub>r.m.s.</sub>              |
| <b>Modulation:</b>      | 1kHz Sine Wave, 80%, AM Modulation |
| <b>Frequency Step:</b>  | 1 % of fundamental                 |
| <b>Coupled Cable:</b>   | Power Mains, Signal Line           |
| <b>Coupling Device:</b> | CDN-M2 (2 wires), CDN-T4, EM-Clamp |



## 5.8.2 TEST INSTRUMENTS

| DESCRIPTION & MANUFACTURER                                     | MODEL NO.          | SERIAL NO. | CALIBRATED DATE | CALIBRATED UNTIL |
|--|--------------------|------------|-----------------|------------------|
| ROHDE & SCHWARZ<br>Signal Generator                            | SMY01              | 841104/033 | Nov. 23, 2011   | Nov. 22, 2012    |
| Digital Sweep<br>Function Generator                            | 8120               | 984801     | NA              | NA               |
| AR Power Amplifier   | 75A250AM1          | 312196     | NA              | NA               |
| FCC Coupling<br>Decoupling Network                             | FCC-801-M<br>3-25A | 48         | Aug. 19, 2011   | Aug. 18, 2012    |
| FCC Coupling<br>Decoupling Network                             | FCC-801-M<br>3-25A | 01022      | Feb. 25, 2011   | Feb. 24, 2012    |
| FCC Coupling<br>Decoupling Network                             | FCC-801-M<br>2-16A | 01047      | Aug. 19, 2011   | Aug. 18, 2012    |
| FISCHER CUSTOM<br>COMMUNICATIONS<br>EM Injection Clamp         | FCC-203I           | 50         | NA              | NA               |
| FISCHER CUSTOM<br>COMMUNICATIONS<br>Current Injection<br>Clamp | F-120-9A           | 361        | NA              | NA               |
| EM TEST Coupling<br>Decoupling Network                         | CDN<br>M1/32A      | 306508     | Feb. 25, 2011   | Feb. 24, 2012    |
| FCC Coupling<br>Decoupling Network                             | FCC-801-T8         | 02038      | Feb. 25, 2011   | Feb. 24, 2012    |
| FCC Coupling<br>Decoupling Network                             | FCC-801-T4         | 02031      | Feb. 25, 2011   | Feb. 24, 2012    |
| FCC Coupling<br>Decoupling Network                             | FCC-801-T2         | 02021      | Feb. 25, 2011   | Feb. 24, 2012    |
| R&S Power Sensor   | NRV-Z5             | 837878/038 | Nov. 15, 2011   | Nov. 14, 2012    |
| R&S Power Sensor   | NRV-Z5             | 837878/039 | Nov. 14, 2011   | Nov. 13, 2012    |
| R&S Power Meter  | NRVD               | 837794/040 | Nov. 15, 2011   | Nov. 14, 2012    |
| Software   | ADT_CS_V<br>7.4.2  | NA         | NA              | NA               |

- NOTE:** 1. The test was performed in CS Room No. 1.  
 2. The calibration interval of the above test instruments is 12 months and the calibrations are traceable to NML/ROC and NIST/USA.

### 5.8.3 TEST PROCEDURE

- a. The EUT shall be tested within its intended operating and climatic conditions.
- b. An artificial hand was placed on the hand-held accessory and connected to the ground reference plane.
- c. One of the CDNs not used for injection was terminated with  $50\ \Omega$ , providing only one return path. All other CDNs were coupled as decoupling networks.
- d. The frequency range is swept from 150 kHz to 80 MHz, using the signal level established during the setting process and with a disturbance signal of 80 % amplitude. The signal is modulated with a 1 kHz sine wave, pausing to adjust the RF signal level or the switch coupling devices as necessary. Where the frequency is swept incrementally, the step size shall not exceed 1 % of the preceding frequency value.
- e. The dwell time of the amplitude modulated carrier at each frequency shall not be less than the time necessary for the EUT to be exercised and to respond, but shall in no case be less than 0,5 s. The sensitive frequencies (e.g. clock frequencies) shall be analyzed separately.
- f. Attempts should be made to fully exercise the EUT during testing, and to fully interrogate all exercise modes selected for susceptibility.

### 5.8.4 DEVIATION FROM TEST STANDARD

No deviation

## 5.8.5 TEST SETUP

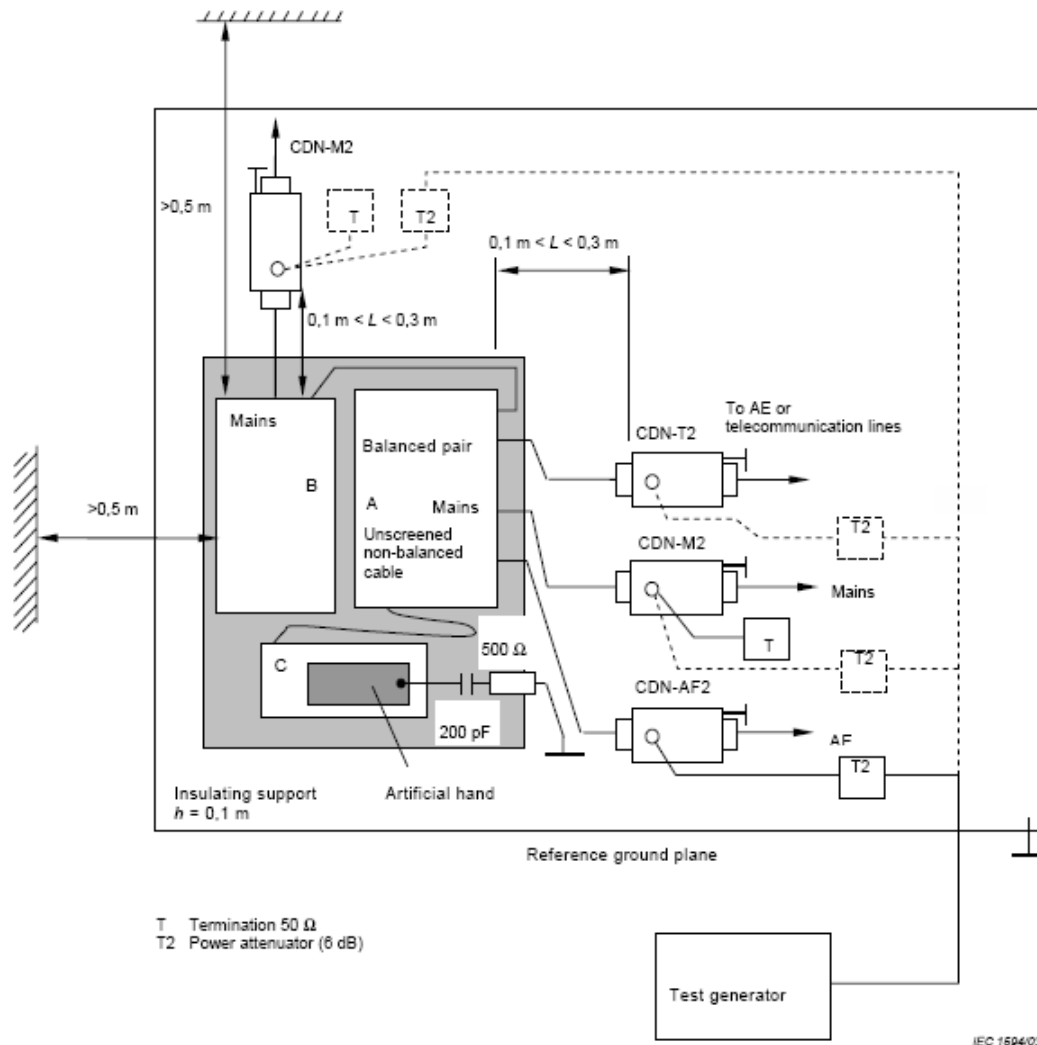

For the actual test configuration, please refer to the related item – Photographs of the Test Configuration.

- Note:**
1. The EUT clearance from any metallic obstacles shall be at least 0,5 m.
  2. Interconnecting cables ( $\leq 1$  m) belonging to the EUT shall remain on the insulating support.
  3. The equipment to be tested is placed on an insulating support of 0.1 meters height above a ground reference plane. All relevant cables shall be provided with the appropriate coupling and decoupling devices at a distance between 0.1 meters and 0.3 meters from the projected geometry of the EUT on the ground reference plane.

## 5.8.6 TEST RESULTS

|                                 |                  |                                 |              |
|---------------------------------|------------------|---------------------------------|--------------|
| <b>TEST MODE</b>                | Mode 1           | <b>INPUT POWER (AC ADAPTER)</b> | 230Vac, 50Hz |
| <b>ENVIRONMENTAL CONDITIONS</b> | 20deg. C, 68% RH | <b>TESTED BY:</b> Ryan Chen     |              |

| <b>FREQUENCY (MHz)</b> | <b>FIELD STRENGTH (V<sub>r.m.s.</sub>)</b> | <b>CABLE</b>          | <b>INJECTION METHOD</b> | <b>RETURN PATH</b> | <b>OBSERVATION</b> | <b>PERFORMANCE CRITERION</b> |
|------------------------|--|-----------------------|-------------------------|--------------------|--------------------|------------------------------|
| 0.15 – 80              | 3  | AC power line         | CDN-M2                  | CDN-T4             | Note               | A                            |
| 0.15 – 80              | 3  | RJ45                  | CDN-T4                  | CDN-M2             | Note               | A                            |
| 0.15 – 80              | 3  | Digital Cable (DI/DO) | EM-Clamp                | CDN-M2             | Note               | A                            |

**NOTE:** There was no change compared with the initial operation during the test.

## 5.9 POWER FREQUENCY MAGNETIC FIELD IMMUNITY TEST

### 5.9.1 TEST SPECIFICATION

|                          |                             |
|--------------------------|-----------------------------|
| <b>Basic Standard:</b>   | IEC 61000-4-8               |
| <b>Frequency Range:</b>  | 50Hz                        |
| <b>Field Strength:</b>   | 1 A/m                       |
| <b>Observation Time:</b> | 1 minute                    |
| <b>Inductance Coil:</b>  | Rectangular type, 1 m x 1 m |

### 5.9.2 TEST INSTRUMENTS

| DESCRIPTION & MANUFACTURER     | MODEL NO. | SERIAL NO. | CALIBRATED DATE | CALIBRATED UNTIL |
|--------------------------------|-----------|------------|-----------------|------------------|
| HAEFELY Magnetic Field Tester  | MAG 100.1 | 083794-06  | NA              | NA               |
| COMBINOVA Magnetic Field Meter | MFM10     | 224        | Mar. 02, 2011   | Mar. 01, 2012    |

- NOTE:** 1. The test was performed in EMS Room No. 1.  
 2. The calibration interval of the above test instruments is 12 months and the calibrations are traceable to NML/ROC and NIST/USA.

### 5.9.3 TEST PROCEDURE

- The equipment is configured and connected to satisfy its functional requirements.
- The power supply, input and output circuits shall be connected to the sources of power supply, control and signal.
- The cables supplied or recommended by the equipment manufacturer shall be used. 1 meter of all cables used shall be exposed to the magnetic field.

### 5.9.4 DEVIATION FROM TEST STANDARD

No deviation



## 5.9.5 TEST SETUP

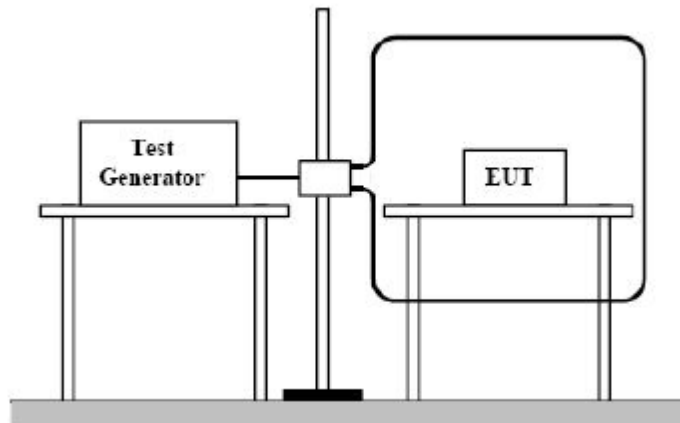

For the actual test configuration, please refer to the related item – Photographs of the Test Configuration.

### **NOTE:**

#### TABLETOP EQUIPMENT

The equipment shall be subjected to the test magnetic field by using the induction coil of standard dimension (1 m x 1 m). The induction coil shall then be rotated by 90 degrees in order to expose the EUT to the test field with different orientations.

#### FLOOR-STANDING EQUIPMENT

The equipment shall be subjected to the test magnetic field by using induction coils of suitable dimensions. The test shall be repeated by moving and shifting the induction coils, in order to test the whole volume of the EUT for each orthogonal direction. The test shall be repeated with the coil shifted to different positions along the side of the EUT, in steps corresponding to 50 % of the shortest side of the coil. The induction coil shall then be rotated by 90 degrees in order to expose the EUT to the test field with different orientations.



## 5.9.6 TEST RESULTS

|                                     |                  |                                     |              |
|-------------------------------------|------------------|-------------------------------------|--------------|
| <b>TEST MODE</b>                    | Mode 1           | <b>INPUT POWER<br/>(AC ADAPTER)</b> | 230Vac, 50Hz |
| <b>ENVIRONMENTAL<br/>CONDITIONS</b> | 20deg. C, 68% RH | <b>TESTED BY:</b> Ryan Chen         |              |

| <b>Direction</b> | <b>Field Strength<br/>(A/m)</b> | <b>Observation</b> | <b>Performance<br/>Criterion</b> |
|------------------|---------------------------------|--------------------|----------------------------------|
| X - Axis         | 1                               | Note               | A                                |
| Y - Axis         | 1                               | Note               | A                                |
| Z - Axis         | 1                               | Note               | A                                |

**NOTE:** There was no change compared with the initial operation during the test.

## 6 PHOTOGRAPHS OF THE TEST CONFIGURATION

### CONDUCTED EMISSION TEST – For Mode 1



## CONDUCTED EMISSION TEST – For Mode 2



## TELECOMMUNICATION PORT - RJ45 OF CONDUCTED EMISSION TEST – For Mode 1



## TELECOMMUNICATION PORT - RJ45 OF CONDUCTED EMISSION TEST – For Mode 2



### RADIATED EMISSION TEST – For Mode 1 <Frequency Range 30MHz ~ 1GHz>



RADIATED EMISSION TEST – For Mode 1  
<Frequency Range above 1GHz>







A D T

## RADIATED EMISSION TEST – For Mode 2 <Frequency Range 30MHz ~ 1GHz>



## RADIATED EMISSION TEST – For Mode 2 <Frequency Range above 1GHz>



### ESD TEST



### ESD TEST POINT

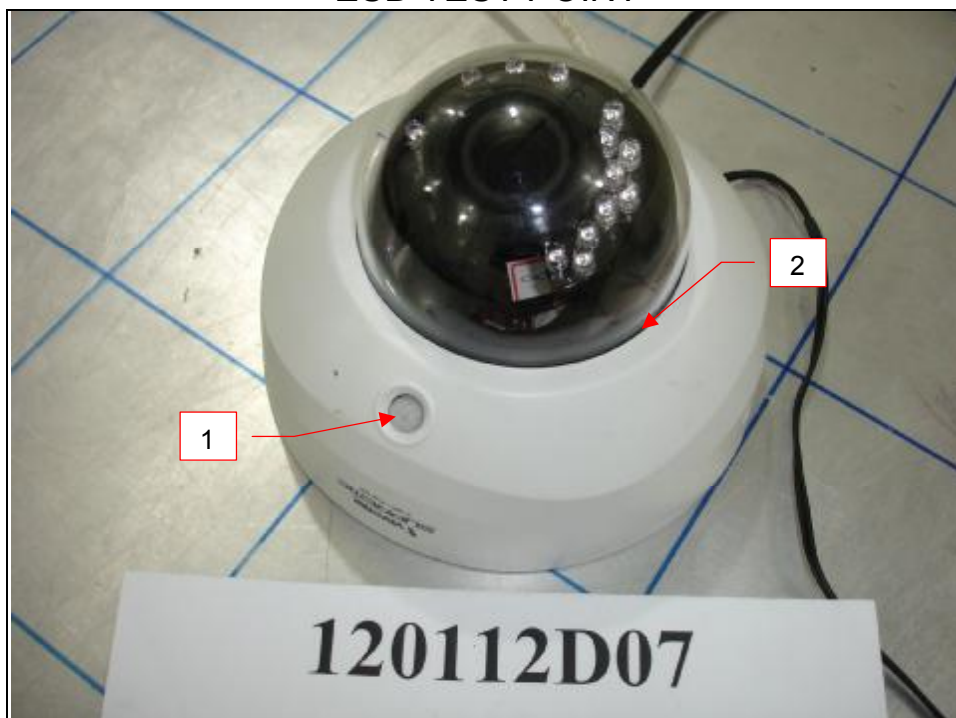

## RS TEST

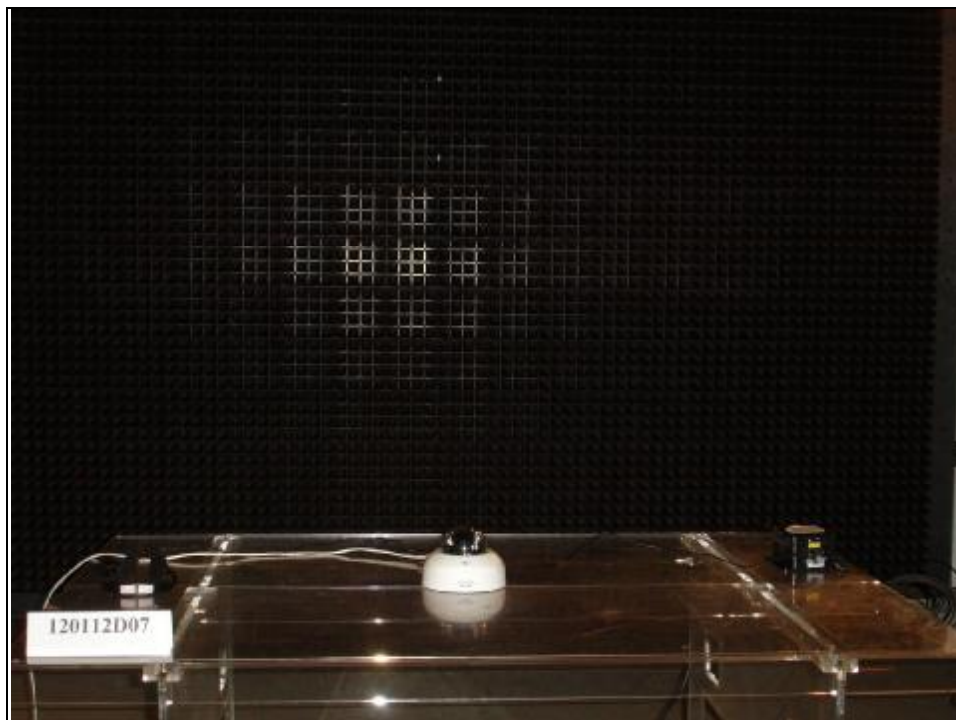

## EFT TEST

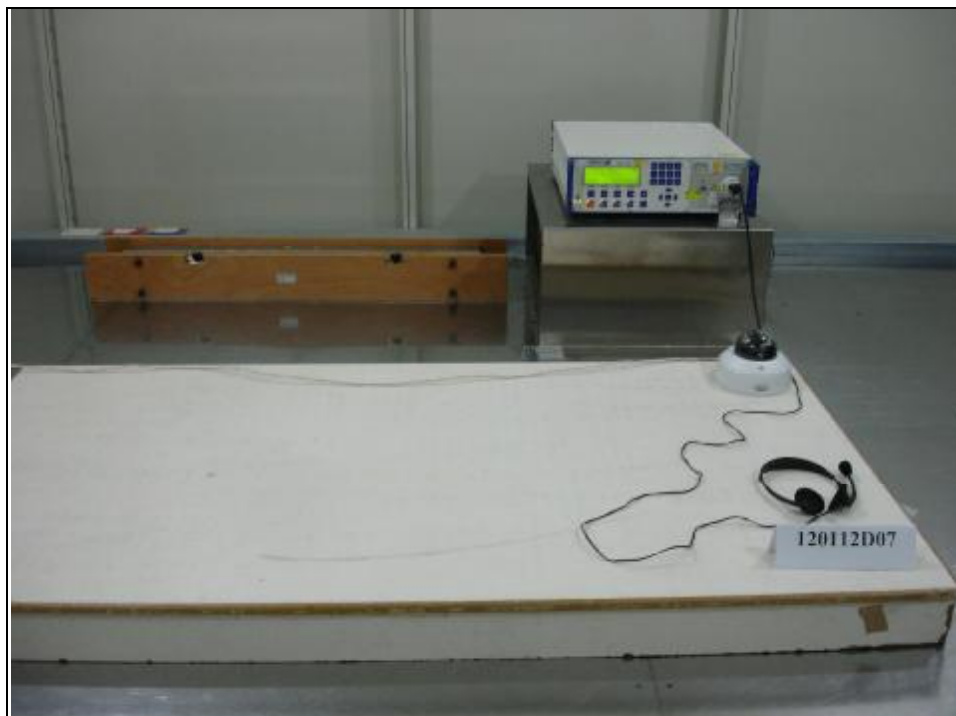

## EFT TEST – Cat. 5 Line



### EFT TEST – Digital Line (DI/DO)



### SURGE TEST



## CONDUCTED SUSCEPTIBILITY TEST

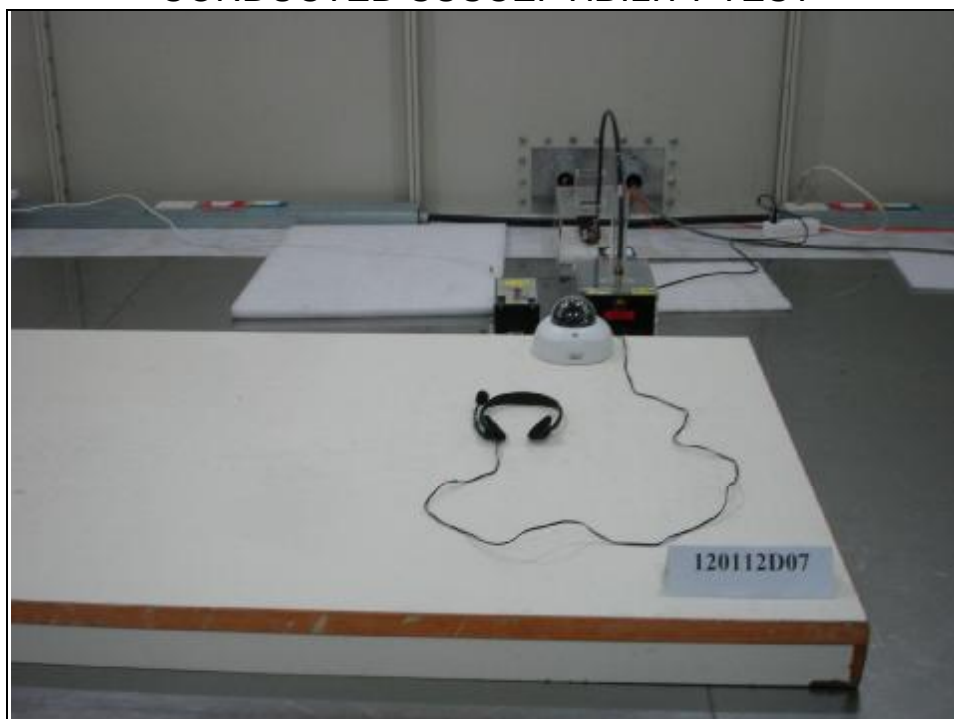

## CONDUCTED SUSCEPTIBILITY TEST – Cat. 5 Line

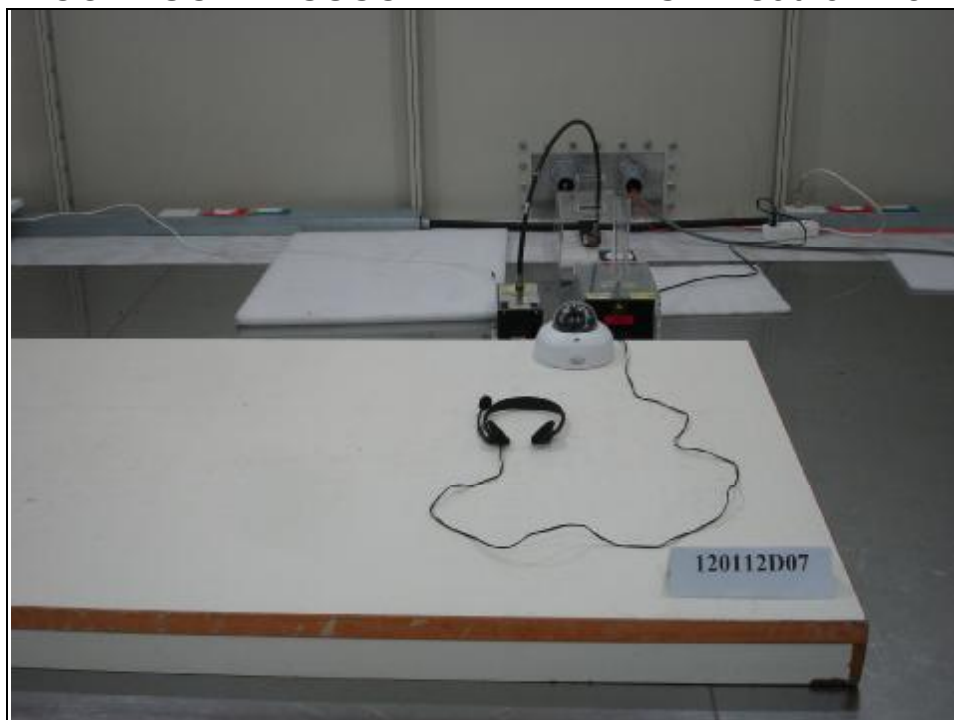



## CONDUCTED SUSCEPTIBILITY TEST – EM-Clamp (Digital Line– DI/DO)

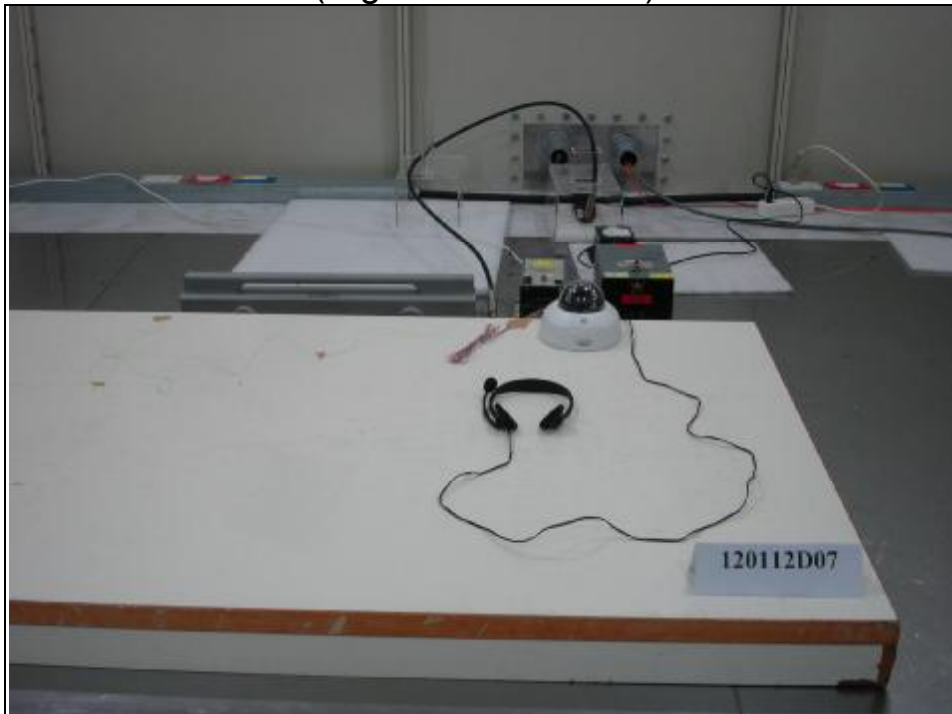

## POWER-FREQUENCY MAGNETIC FIELDS TEST





## 7 APPENDIX - INFORMATION ON THE TESTING LABORATORIES

We, Bureau Veritas Consumer Products Services (H.K.) Ltd., Taoyuan Branch, were founded in 1988 to provide our best service in EMC, Radio, Telecom and Safety consultation. Our laboratories are accredited and approved according to ISO/IEC 17025.

Copies of accreditation and authorization certificates of our laboratories obtained from approval agencies can be downloaded from our web site: [www.adt.com.tw/index.5.phtml](http://www.adt.com.tw/index.5.phtml). If you have any comments, please feel free to contact us at the following:

**Linko EMC/RF Lab:**  
Tel: 886-2-26052180  
Fax: 886-2-26051924

**Hsin Chu EMC/RF Lab:**  
Tel: 886-3-5935343  
Fax: 886-3-5935342

**Hwa Ya EMC/RF/Safety/Telecom Lab:**  
Tel: 886-3-3183232  
Fax: 886-3-3185050

**Email:** [service.adt@tw.bureauveritas.com](mailto:service.adt@tw.bureauveritas.com)  
**Web Site:** [www.adt.com.tw](http://www.adt.com.tw)

The address and road map of all our labs can be found in our web site also.

---END---