



# CERTIFICATE

Issued Date: Oct. 09, 2012  
Report No. : 129427R-ITCEP11V04

This is to certify that the following designated product

**Product** : Network Camera  
**Trade name** : VIVOTEK  
**Model Number** : PD8136  
**Company Name** : VIVOTEK INC.

This product, which has been issued the test report listed as above in QuieTek Laboratory, is based on a single evaluation of one sample and confirmed to comply with the requirements of the following EMC standard.

EN 55022: 2010	EN 55024: 2010
EN 61000-3-2: 2006+A2: 2009	IEC 61000-4-2: 2008
EN 61000-3-3: 2008	IEC 61000-4-3: 2010
AS/NZS CISPR 22: 2009+A1: 2010	IEC 61000-4-4: 2012
CISPR 22: 2008	IEC 61000-4-5: 2005
CISPR 24: 2010	IEC 61000-4-6: 2008
	IEC 61000-4-8: 2009
	IEC 61000-4-11: 2004

TEST LABORATORY

Vincent Lin / Manager



# Test Report

Product Name : Network Camera

Model No. : PD8136

Applicant : VIVOTEK INC.

Address : 6F, No.192, Lien-Cheng Rd., Chung-Ho , New Taipei City,  
235, Taiwan, R.O.C.

Date of Receipt : 2012/09/24

Issued Date : 2012/10/09

Report No. : 129427R-ITCEP11V04

Report Version : V1.0



The test results relate only to the samples tested.

The test results shown in the test report are traceable to the national/international standard through the calibration of the equipment and evaluated measurement uncertainty herein.

This report must not be used to claim product endorsement by TAF, NVLAP or any agency of the Government.

The test report shall not be reproduced except in full without the written approval of Quietek Corporation.



# Declaration of Conformity

We herewith confirm the following designated products to comply with the requirements set out in the Council Directive on the approximation of the laws of the Member States relating to Electromagnetic Compatibility Directive (2004/108/EC) with applicable standards listed below.

Product : Network Camera  
Trade name : VIVOTEK  
Model Number : PD8136  
Applicable Harmonized : EN 55022: 2010, Class B  
Standards under Directive 2004/108/EC : EN 55024: 2010  
EN 61000-3-2: 2006+A2: 2009, Class A  
EN 61000-3-3: 2008  
AS/NZS CISPR 22: 2009+A1: 2010  
CISPR 22: 2008  
CISPR 24: 2010

Company Name : \_\_\_\_\_  
Company Address : \_\_\_\_\_  
Telephone : \_\_\_\_\_ Facsimile : \_\_\_\_\_

Person in responsible for marking this declaration:

_____	_____
Name (Full Name)	Title/ Department
_____	_____
Date	Legal Signature



Quietek Corporation

Date : Oct. 09, 2012  
QTK No.: 129427R-ITCEP11V04



## Statement of Conformity

This statement is to certify that the designated product below.

Product : Network Camera  
Trade name : VIVOTEK  
Model Number : PD8136  
Company Name : VIVOTEK INC.  
Applicable Standards : EN 55022: 2010, Class B  
EN 55024: 2010  
EN 61000-3-2: 2006+A2: 2009, Class A  
EN 61000-3-3: 2008  
AS/NZS CISPR 22: 2009+A1: 2010  
CISPR 22: 2008  
CISPR 24: 2010

One sample of the designated product has been tested and evaluated in our laboratory to find in compliance with the applicable standards above. The issued test report(s) show(s) it in detail.

**Report Number : 129427R-ITCEP11V04**

TEST LABORATORY

Vincent Lin / Manager

The verification is based on a single evaluation of one sample of above-mentioned products. It does not imply an assessment of the whole production and does not permit the use of the test lab. Logo.

# Test Report Certification

Issued Date : 2012/10/09

Report No. : 129427R-ITCEP11V04



Product Name : Network Camera  
 Applicant : VIVOTEK INC.  
 Address : 6F, No.192, Lien-Cheng Rd., Chung-Ho , New Taipei City,  
 235, Taiwan, R.O.C.  
 Manufacturer : VIVOTEK INC.  
 Model No. : PD8136  
 EUT Rated Voltage : By POE  
 EUT Test Voltage : By POE  
 Trade Name : VIVOTEK  
 Applicable Standard : EN 55022: 2010, Class B  
 EN 55024: 2010  
 EN 61000-3-2:2006+A2: 2009  
 EN 61000-3-3:2008  
 AS/NZS CISPR 22: 2009+A1: 2010  
 CISPR 22: 2008  
 CISPR 24: 2010  
 Test Result : Complied  
 Performed Location : Quietek Corporation (Linkou Laboratory)  
 No. 5-22, Rueishu Keng, Linkou Dist., New Taipei City  
 24451, Taiwan. R.O.C.  
 TEL:+866-2-8601-3788 / FAX:+886-2-8601-3789

Documented By : Anny Chou  
 (Adm. Specialist / Anny Chou)

Reviewed By : kevin ker  
 ( Engineer / Kevin Ker )

Approved By : [Signature]  
 ( Manager / Vincent Lin )

## Laboratory Information

We, **Quietek Corporation**, are an independent EMC and safety consultancy that was established the whole facility in our laboratories. The test facility has been accredited/accepted (audited or listed) by the following related bodies in compliance with ISO 17025, EN 45001 and specified testing scopes:

<b>Taiwan R.O.C.</b>	<b>:</b>	<b>BSMI, NCC, TAF</b>
<b>Norway</b>	<b>:</b>	<b>Nemko, DNV</b>
<b>USA</b>	<b>:</b>	<b>FCC, NVLAP</b>
<b>Japan</b>	<b>:</b>	<b>VCCI</b>

The related certificate for our laboratories about the test site and management system can be downloaded from Quietek Corporation's Web Site : <http://www.quietek.com/tw/ctg/cts/accreditations.htm>

The address and introduction of Quietek Corporation's laboratories can be founded in our Web site : <http://www.quietek.com/>

If you have any comments, Please don't hesitate to contact us. Our contact information is as below:

### HsinChu Testing Laboratory :

No.75-2, 3<sup>rd</sup> Lin, Wangye Keng, Yonghxing Tsuen, Qionglin Shiang, Hsinchu County 307, Taiwan, R.O.C.

TEL:+886-3-592-8858 / FAX:+886-3-592-8859      E-Mail : [service@quietek.com](mailto:service@quietek.com)

### Linkou Testing Laboratory :

No.5-22, Ruishukeng, Linkou Dist., New Taipei City 24451, Taiwan, R.O.C.

TEL : 886-2-8601-3788 / FAX : 886-2-8601-3789      E-Mail : [service@quietek.com](mailto:service@quietek.com)



### Suzhou (China) Testing Laboratory :

No. 99 Hongye Rd., Suzhou Industrial Park Loufeng Hi-Tech Development Zone., Suzhou, China.

TEL : +86-512-6251-5088 / FAX : +86-512-6251-5098      E-Mail : [service@quietek.com](mailto:service@quietek.com)

**TABLE OF CONTENTS**

Description	Page
1. General Information .....	7
1.1. EUT Description.....	7
1.2. Mode of Operation .....	8
1.3. Tested System Details .....	9
1.4. Configuration of Tested System .....	10
1.5. EUT Exercise Software.....	11
2. Technical Test .....	12
2.1. Summary of Test Result.....	12
2.2. List of Test Equipment .....	13
2.3. Measurement Uncertainty.....	15
2.4. Test Environment.....	17
3. Conducted Emissions (Telecommunication Ports).....	18
3.1. Test Specification .....	18
3.2. Test Setup.....	18
3.3. Limit .....	18
3.4. Test Procedure .....	19
3.5. Deviation from Test Standard.....	19
3.6. Test Result .....	20
3.7. Test Photograph .....	26
4. Radiated Emission.....	27
4.1. Test Specification .....	27
4.2. Test Setup.....	27
4.3. Limit .....	28
4.4. Test Procedure .....	29
4.5. Deviation from Test Standard.....	29
4.6. Test Result .....	30
4.7. Test Photograph .....	36
5. Electrostatic Discharge .....	38
5.1. Test Specification .....	38
5.2. Test Setup.....	38
5.3. Limit .....	38
5.4. Test Procedure .....	39
5.5. Deviation from Test Standard.....	39
5.6. Test Result .....	40
5.7. Test Photograph .....	41
6. Radiated Susceptibility .....	42

6.1.	Test Specification .....	42
6.2.	Test Setup.....	42
6.3.	Limit.....	42
6.4.	Test Procedure .....	43
6.5.	Deviation from Test Standard.....	43
6.6.	Test Result .....	44
6.7.	Test Photograph .....	45
7.	Electrical Fast Transient/Burst .....	48
7.1.	Test Specification .....	48
7.2.	Test Setup.....	48
7.3.	Limit.....	48
7.4.	Test Procedure .....	49
7.5.	Deviation from Test Standard.....	49
7.6.	Test Result .....	50
7.7.	Test Photograph .....	51
8.	Surge .....	52
8.1.	Test Specification .....	52
8.2.	Test Setup.....	52
8.3.	Limit.....	52
8.4.	Test Procedure .....	53
8.5.	Deviation from Test Standard.....	53
8.6.	Test Result .....	54
8.7.	Test Photograph .....	55
9.	Conducted Susceptibility.....	56
9.1.	Test Specification .....	56
9.2.	Test Setup.....	56
9.3.	Limit.....	57
9.4.	Test Procedure .....	57
9.5.	Deviation from Test Standard.....	57
9.6.	Test Result .....	58
9.7.	Test Photograph .....	59
10.	Power Frequency Magnetic Field .....	60
10.1.	Test Specification .....	60
10.2.	Test Setup.....	60
10.3.	Limit.....	60
10.4.	Test Procedure .....	60
10.5.	Deviation from Test Standard.....	60
10.6.	Test Result .....	61



10.7. Test Photograph ..... 62

11. Attachment ..... 63

    EUT Photograph ..... 63

## 1. General Information

### 1.1. EUT Description

Product Name	Network Camera
Trade Name	VIVOTEK
Model No.	PD8136

**1.2. Mode of Operation**

Quietek has verified the construction and function in typical operation. All the test modes were carried out with the EUT in normal operation, which was shown in this test report and defined as:

Pre-Test Mode	
Mode 1: POE Mode	
Final Test Mode	
Emission	Mode 1: POE Mode
Immunity	Mode 1: POE Mode

**1.3. Tested System Details**

The types for all equipments, plus descriptions of all cables used in the tested system (including inserted cards) ssare:

Product	Manufacturer	Model No.	Serial No.	Power Cord	
1	Notebook PC	DELL	PP04X	7607342512	Non-Shielded, 1.8m
2	PoE	VIVOTEK	IJ-1748NDN	N/A	Non-Shielded, 1.8m
3	Micro SD Card 1GB	SanDisk	N/A	0801002841D2N	N/A

### 1.4. Configuration of Tested System

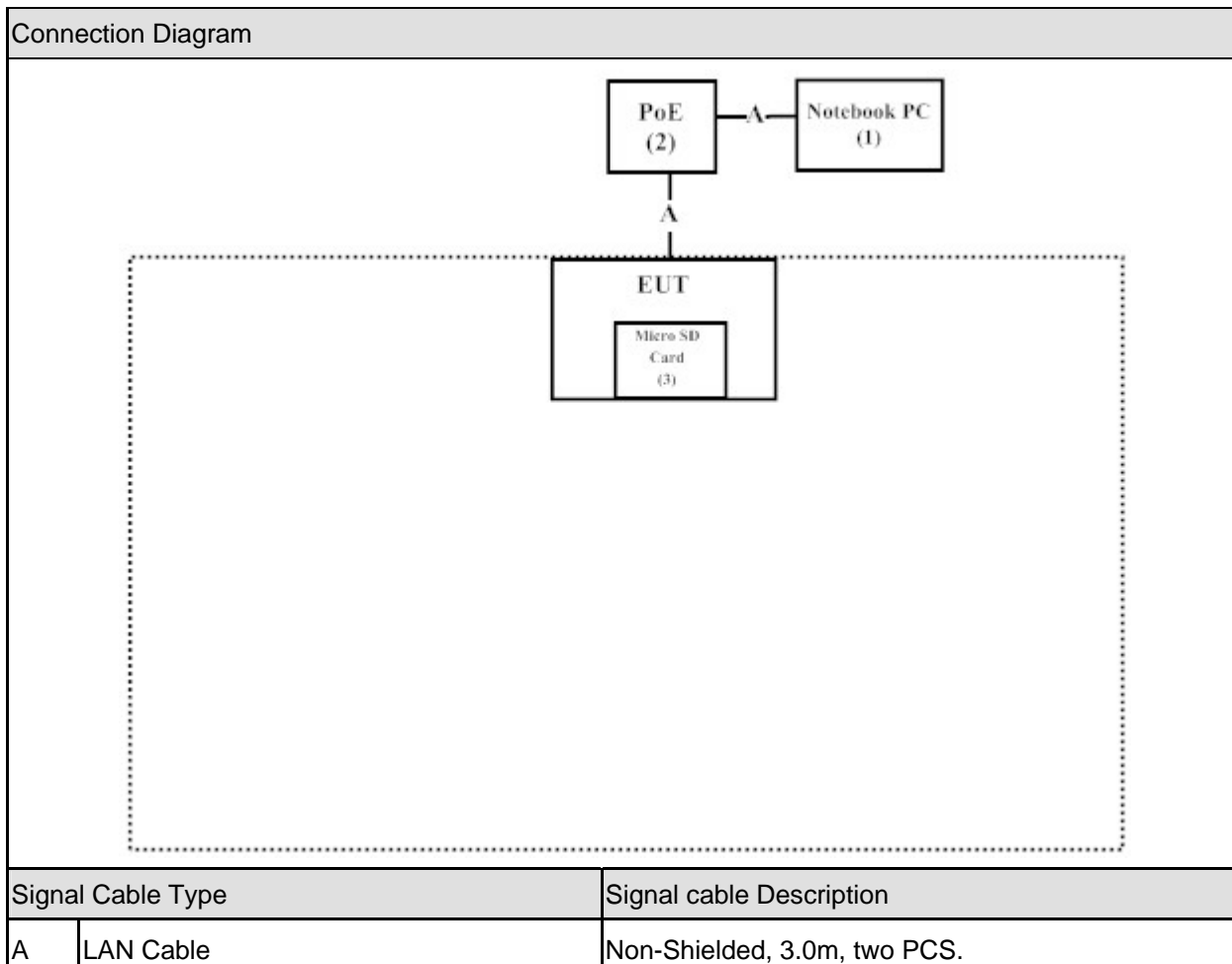

**1.5. EUT Exercise Software**

1	Setup the EUT and simulators as shown on 1.4.
2	Turn on the power of all equipment.
3	The EUT will start to operate and display the video figure from the signal source.
4	The EUT will display “video figure” on monitor.
5	SD card works while the EUT is recording.
6	Repeat the above procedure (3) to (5).

## 2. Technical Test

### 2.1. Summary of Test Result

- No deviations from the test standards  
 Deviations from the test standards as below description:

Emission			
Performed Item	Normative References	Test Performed	Deviation
Conducted Emission	EN 55022: 2010 AS/NZS CISPR 22: 2009+A1: 2010	No	No
Impedance Stabilization Network	EN 55022: 2010 AS/NZS CISPR 22: 2009+A1: 2010	Yes	No
Radiated Emission	EN 55022: 2010 AS/NZS CISPR 22: 2009+A1: 2010	Yes	No
Power Harmonics	EN 61000-3-2:2006+A2: 2009	No	No
Voltage Fluctuation and Flicker	EN 61000-3-3:2008	No	No

Immunity			
Performed Item	Normative References	Test Performed	Deviation
Electrostatic Discharge	IEC 61000-4-2: 2008	Yes	No
Radiated susceptibility	IEC 61000-4-3: 2010	Yes	No
Electrical fast transient/burst	IEC 61000-4-4: 2012	Yes	No
Surge	IEC 61000-4-5: 2005	Yes	No
Conducted susceptibility	IEC 61000-4-6: 2008	Yes	No
Power frequency magnetic field	IEC 61000-4-8: 2009	Yes	No
Voltage dips and interruption	IEC 61000-4-11: 2004	No	No

## 2.2. List of Test Equipment

### Impedance Stabilization Network / SR1

Instrument	Manufacturer	Type No.	Serial No	Cal. Date
Capacitive Voltage Probe	Schaffner	CVP2200A	18331	2011/11/14
EMI Test Receiver	R&S	ESCS 30	838251/001	2012/06/05
LISN	R&S	ENV216	100085	2012/02/13
LISN	R&S	ESH3-Z5	836679/023	2012/01/12
Pulse Limiter	R&S	ESH3-Z2	357.8810.52-1	2012/09/20
RF Current Probe	FCC	F-65 10KHz~1GHz	198	2011/10/25
BALANCED TELECOM ISN	FCC	FCC-TLISN-T2-02	20316	2012/07/22
BALANCED TELECOM ISN	FCC	FCC-TLISN-T4-02	20317	2012/07/22
BALANCED TELECOM ISN	FCC	FCC-TLISN-T8-02	20623	2012/07/22

### Radiated Emission / Site 7

Instrument	Manufacturer	Type No.	Serial No	Cal. Date
EMI Test Receiver	R&S	ESCI	100648	2011/10/13
Bilog Antenna	Schaffner Chase	CBL6112B	2930	2012/07/06
Pre-Amplifier	QTK	AP-025C	071919	2012/07/07
Site7 NSA	QTK	N/A	N/A	2012/06/27

### Radiated Emission / CB7

Instrument	Manufacturer	Type No.	Serial No	Cal. Date
EMI Test Receiver	Agilent	E4440A	MY46185846	2011/12/12
Horn Antenna	ETS-Lindgren	3117	00135205	2012/03/30
Horn Antenna	SCHWARZBECK	9120D	576	2011/11/14
Pre-Amplifier	Quietek	AP-180C	CHM/071920	2012/07/12
CB7 VSWR	QTK	N/A	N/A	2012/08/25

### Electrostatic Discharge / SR6

Instrument	Manufacturer	Type No.	Serial No	Cal. Date
ESD Simulator System	Noiseken	TC-815R	ESS0929097	2012/06/21
Horizontal Coupling Plane(HCP)	Quietek	HCP AL50	N/A	N/A
Vertical Coupling Plane(VCP)	Quietek	VCP AL50	N/A	N/A

### Radiated susceptibility / CB5

Instrument	Manufacturer	Type No.	Serial No	Cal. Date
AF-BOX	R&S	AF-BOX ACCUST	100007	N/A
Audio Analyzer	R&S	UPL 16	100137	2012/05/15
Biconilog Antenna	EMCO	3149	00071675	N/A
Directional Coupler	A&R	DC 6180	22735	N/A
Power Amplifier	A&R	30S1G3	309453	N/A
Power Amplifier	A&R	100W10000M7	A285000010	N/A
Power Amplifier	SCHAFFNER	CBA9413B	4020	N/A
Power Amplifier	AR	75A250A	0325371	N/A
Power Meter	R&S	NRVD(P.M)	100219	2012/05/18
Pre-Amplifier	A&R	150A220	23067	N/A
Signal Generator	R&S	SMT03	100170	2012/05/16



Electrical fast transient/burst / SR3

Instrument	Manufacturer	Type No.	Serial No	Cal. Date
TRANSIENT TEST SYSTEM	EMC PARTNER	TRA2000IN6	1138	2011/11/30

Surge / SR3

Instrument	Manufacturer	Type No.	Serial No	Cal. Date
TRANSIENT TEST SYSTEM	EMC PARTNER	TRA2000IN6	1138	2011/11/30

Conducted susceptibility / SR6

Instrument	Manufacturer	Type No.	Serial No	Cal. Date
TESEQ RF-Generator	TESEQ	NSG 4070A-30	032847	2012/08/08

Power frequency magnetic field / SR3

Instrument	Manufacturer	Type No.	Serial No	Cal. Date
Induction Coil Interface	Schaffner	INA 2141	6002	N/A
Magnetic Loop Coil	Schaffner	INA 702	160	N/A

## 2.3. Measurement Uncertainty

### Impedance Stabilization Network

The measurement uncertainty is evaluated as  $\pm 2.26$  dB.

### Radiated Emission

The measurement uncertainty is evaluated as  $\pm 3.19$  dB.

### Electrostatic Discharge

As what is concluded in the document from Note2 of clause 5.4.6.2 of ISO/IEC 17025, the requirements for measurement uncertainty in ESD testing are deemed to have been satisfied, and the testing is reported in accordance with the relevant ESD standards. The immunity test signal from the ESD system meet the required specifications in IEC 61000-4-2 through the calibration report with the calibrated uncertainty for the waveform of voltage and timing as being 3.0 % and 3.8%.

### Radiated susceptibility

As what is concluded in the document from Note2 of clause 5.4.6.2 of ISO/IEC 17025, the requirements for measurement uncertainty in RS testing are deemed to have been satisfied, and the testing is reported in accordance with the relevant RS standards. The immunity test signal from the RS system meet the required specifications in IEC 61000-4-3 through the calibration for the uniform field strength and monitoring for the test level with the uncertainty evaluation report for the electrical filed strength as being 3.57 dB.

### Electrical fast transient/burst

As what is concluded in the document from Note2 of clause 5.4.6.2 of ISO/IEC 17025, the requirements for measurement uncertainty in EFT/Burst testing are deemed to have been satisfied, and the testing is reported in accordance with the relevant EFT/Burst standards. The immunity test signal from the EFT/Burst system meet the required specifications in IEC 61000-4-4 through the calibration report with the calibrated uncertainty for the waveform of voltage, frequency and timing as being 4 %, and 2.5%.

### Surge

As what is concluded in the document from Note2 of clause 5.4.6.2 of ISO/IEC 17025, the requirements for measurement uncertainty in Surge testing are deemed to have been satisfied, and the testing is reported in accordance with the relevant Surge standards. The immunity test signal from the Surge system meet the required specifications in IEC 61000-4-5 through the calibration report with the calibrated uncertainty for the waveform of voltage and timing as being 3.5 % and 0.1%.

Conducted susceptibility

As what is concluded in the document from Note2 of clause 5.4.6.2 of ISO/IEC 17025, the requirements for measurement uncertainty in CS testing are deemed to have been satisfied, and the testing is reported in accordance with the relevant CS standards. The immunity test signal from the CS system meet the required specifications in IEC 61000-4-6 through the calibration for unmodulated signal and monitoring for the test level with the uncertainty evaluation report for the injected modulated signal level through CDN and EM Clamp/Direct Injection as being 2.0 dB and 2.61 dB.

Power frequency magnetic field

As what is concluded in the document from Note2 of clause 5.4.6.2 of ISO/IEC 17025, the requirements for measurement uncertainty in PFM testing are deemed to have been satisfied, and the testing is reported in accordance with the relevant PFM standards. The immunity test signal from the PFM system meet the required specifications in IEC 61000-4-8 through the calibration report with the calibrated uncertainty for the Gauss Meter to verify the output level of magnetic field strength as being 2.0 %.

## 2.4. Test Environment

Performed Item	Items	Required	Actual
Impedance Stabilization Network	Temperature (°C)	15-35	25.4
	Humidity (%RH)	25-75	51
	Barometric pressure (mbar)	860-1060	950-1000
Radiated Emission	Temperature (°C)	15-35	23.4
	Humidity (%RH)	25-75	49
	Barometric pressure (mbar)	860-1060	950-1000
Electrostatic Discharge	Temperature (°C)	15-35	23
	Humidity (%RH)	30-60	52
	Barometric pressure (mbar)	860-1060	950-1000
Radiated susceptibility	Temperature (°C)	15-35	23
	Humidity (%RH)	25-75	52
	Barometric pressure (mbar)	860-1060	950-1000
Electrical fast transient/burst	Temperature (°C)	15-35	23
	Humidity (%RH)	25-75	55
	Barometric pressure (mbar)	860-1060	950-1000
Surge	Temperature (°C)	15-35	23
	Humidity (%RH)	10-75	55
	Barometric pressure (mbar)	860-1060	950-1000
Conducted susceptibility	Temperature (°C)	15-35	23
	Humidity (%RH)	25-75	52
	Barometric pressure (mbar)	860-1060	950-1000
Power frequency magnetic field	Temperature (°C)	15-35	23
	Humidity (%RH)	25-75	55
	Barometric pressure (mbar)	860-1060	950-1000

### 3. Conducted Emissions (Telecommunication Ports)

#### 3.1. Test Specification

According to EMC Standard : EN 55022

#### 3.2. Test Setup

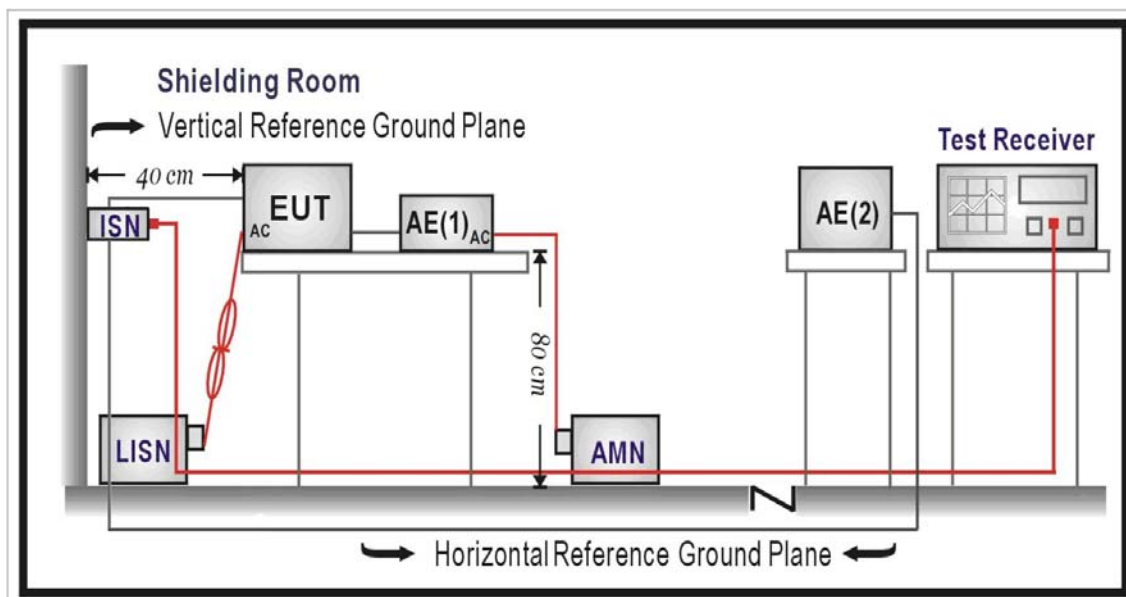

#### 3.3. Limit

Limits		
Frequency (MHz)	QP (dBuV)	AV (dBuV)
0.15 - 0.50	84 – 74	74 – 64
0.50 - 30	74	64

Remarks:

The limit decreases linearly with the logarithm of the frequency in the range 0.15 MHz~0.50 MHz.

### **3.4. Test Procedure**

#### **Telecommunication Port:**

The mains voltage shall be supplied to the EUT via the LISN when the measurement of telecommunication port is performed. The common mode disturbances at the telecommunication port shall be connected to the ISN, which is 150 ohm impedance.

Both alternative cables are tested related to the LCL requested. The measurement range is from 150kHz to 30MHz. The bandwidth of measurement is set to 9kHz.

The 75dB LCL ISN is used for cat. 6 cable, the 65dB LCL ISN is used for cat. 5 cable, 55dB LCL ISN is used for cat. 3.

### **3.5. Deviation from Test Standard**

No deviation.

### 3.6. Test Result

Site : SR8	Time : 2012/09/27 - 20:19
Limit : ISN_Voltage_B_00M_QP	Margin : 10
EUT : Network Camera	Probe : TESEQ_T8 - Line1
Power : By POE	Note : Mode 1, ISN 10M

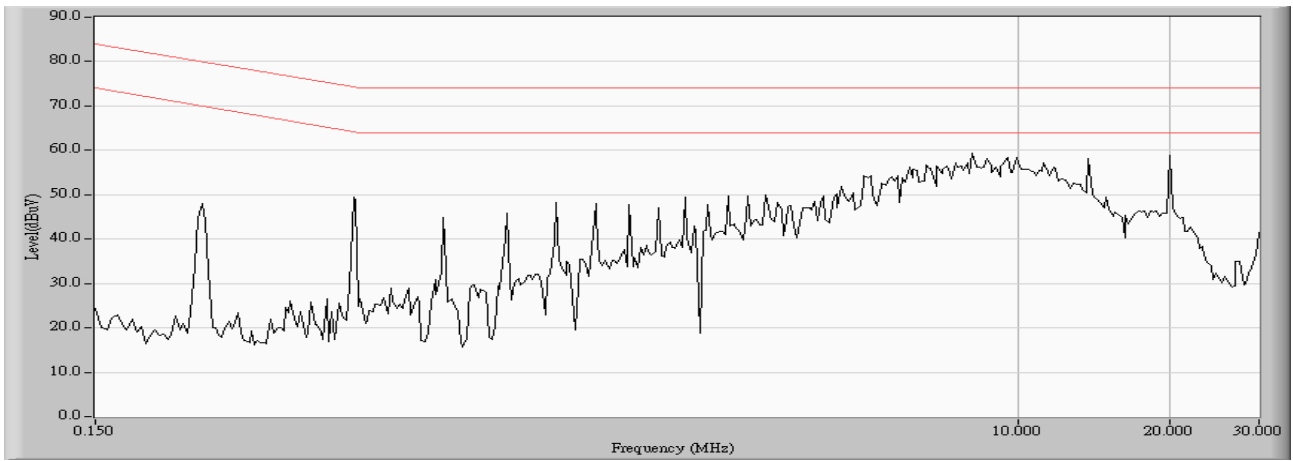

Site : SR8	Time : 2012/09/27 - 20:21
Limit : ISN_Voltage_B_00M_QP	Margin : 0
EUT : Network Camera	Probe : TESEQ_T8 - Line1
Power : By POE	Note : Mode 1, ISN 10M

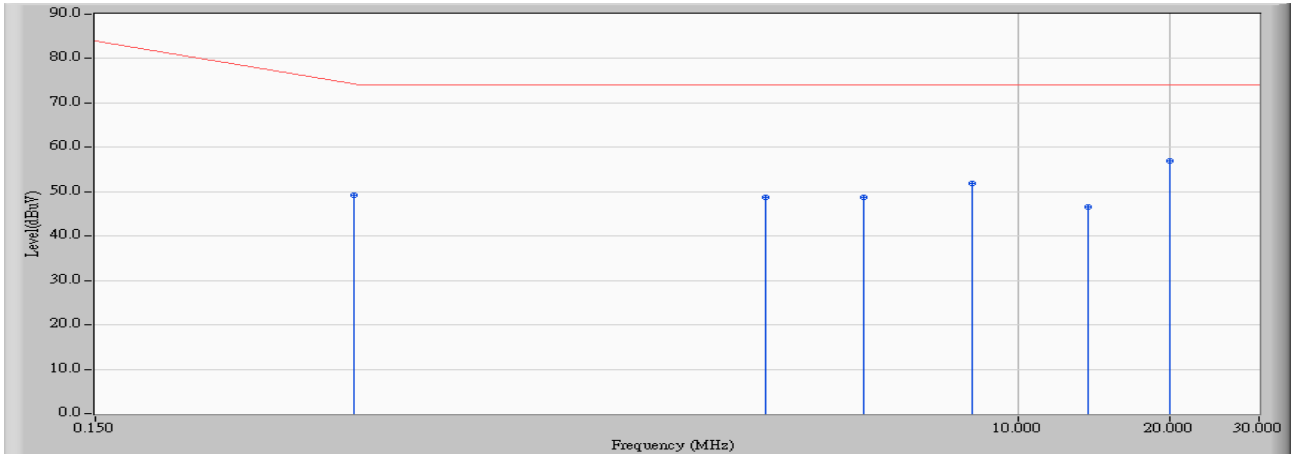

		Frequency (MHz)	Correct Factor (dB)	Reading Level (dBuV)	Measure Level (dBuV)	Margin (dB)	Limit (dBuV)	Detector Type
1		0.486	10.125	38.990	49.115	-25.285	74.400	QUASIPeAK
2		3.170	9.920	38.790	48.710	-25.290	74.000	QUASIPeAK
3		4.955	9.887	38.880	48.767	-25.233	74.000	QUASIPeAK
4		8.123	9.934	41.840	51.774	-22.226	74.000	QUASIPeAK
5		13.744	10.040	36.530	46.570	-27.430	74.000	QUASIPeAK
6	*	20.002	10.160	46.890	57.050	-16.950	74.000	QUASIPeAK

**Note:**

1. All Reading Levels are Quasi-Peak and average value.
2. " \* ", means this data is the worst emission level.
3. Measurement Level = Reading Level + Correct Factor



Site : SR8	Time : 2012/09/27 - 20:21
Limit : ISN_Voltage_B_00M_AV	Margin : 0
EUT : Network Camera	Probe : TESEQ_T8 - Line1
Power : By POE	Note : Mode 1, ISN 10M

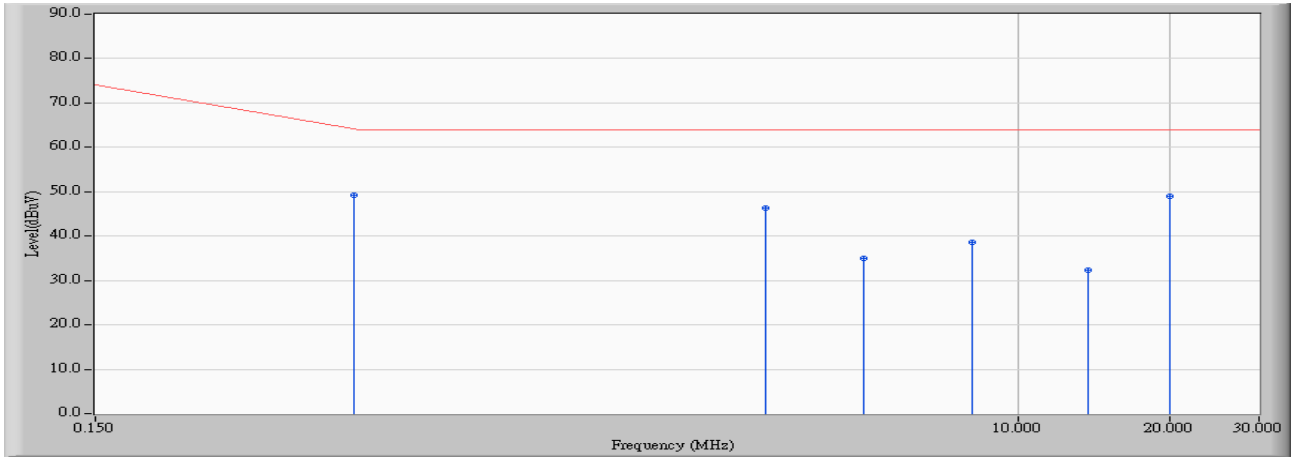

		Frequency (MHz)	Correct Factor (dB)	Reading Level (dBuV)	Measure Level (dBuV)	Margin (dB)	Limit (dBuV)	Detector Type
1		0.486	10.125	38.980	49.105	-15.295	64.400	AVERAGE
2		3.170	9.920	36.350	46.270	-17.730	64.000	AVERAGE
3		4.955	9.887	25.150	35.037	-28.963	64.000	AVERAGE
4		8.123	9.934	28.700	38.634	-25.366	64.000	AVERAGE
5		13.744	10.040	22.370	32.410	-31.590	64.000	AVERAGE
6	*	20.002	10.160	38.930	49.090	-14.910	64.000	AVERAGE

**Note:**

1. All Reading Levels are Quasi-Peak and average value.
2. " \* ", means this data is the worst emission level.
3. Measurement Level = Reading Level + Correct Factor

Site : SR8	Time : 2012/09/27 - 20:22
Limit : ISN_Voltage_B_00M_QP	Margin : 10
EUT : Network Camera	Probe : TESEQ_T8 - Line1
Power : By POE	Note : Mode 1, ISN 100M

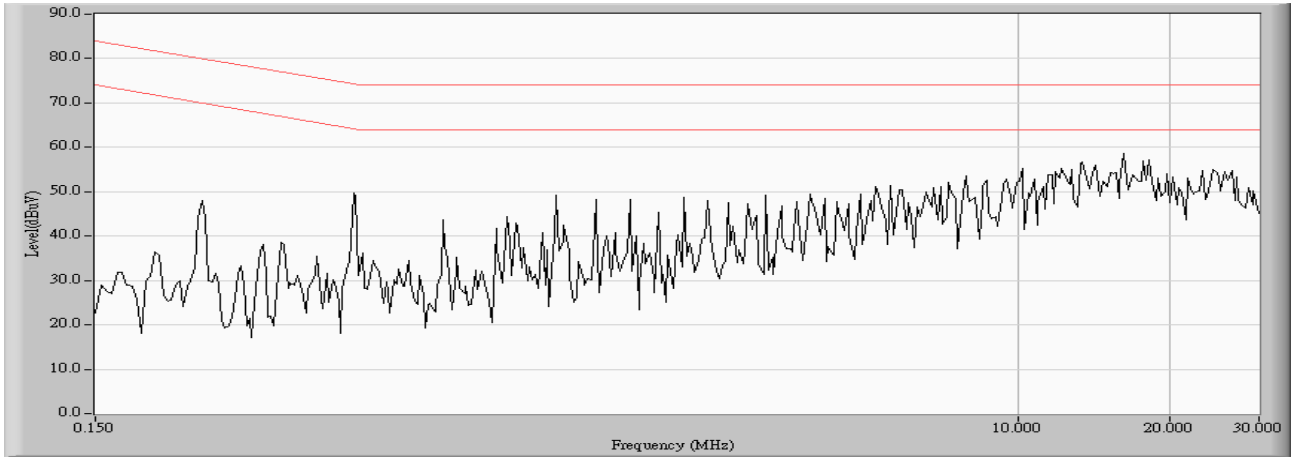

Site : SR8	Time : 2012/09/27 - 20:24
Limit : ISN_Voltage_B_00M_QP	Margin : 0
EUT : Network Camera	Probe : TESEQ_T8 - Line1
Power : By POE	Note : Mode 1, ISN 100M

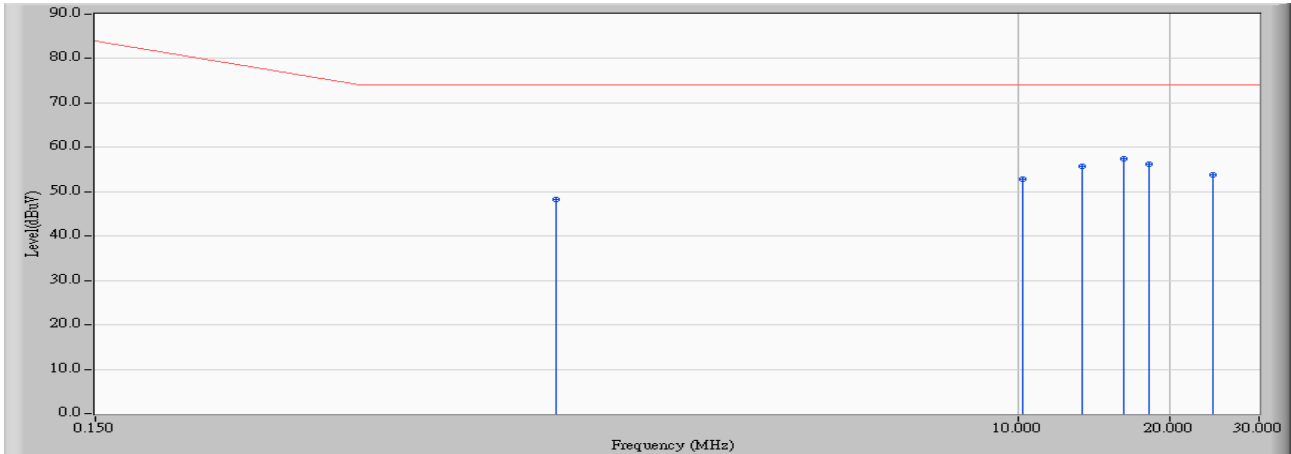

		Frequency (MHz)	Correct Factor (dB)	Reading Level (dBuV)	Measure Level (dBuV)	Margin (dB)	Limit (dBuV)	Detector Type
1		1.220	9.990	38.380	48.370	-25.630	74.000	QUASPEAK
2		10.244	9.966	42.810	52.776	-21.224	74.000	QUASPEAK
3		13.420	10.034	45.640	55.674	-18.326	74.000	QUASPEAK
4	*	16.228	10.090	47.420	57.510	-16.490	74.000	QUASPEAK
5		18.244	10.130	46.070	56.200	-17.800	74.000	QUASPEAK
6		24.349	10.262	43.600	53.862	-20.138	74.000	QUASPEAK

**Note:**

1. All Reading Levels are Quasi-Peak and average value.
2. " \* ", means this data is the worst emission level.
3. Measurement Level = Reading Level + Correct Factor

Site : SR8	Time : 2012/09/27 - 20:24
Limit : ISN_Voltage_B_00M_AV	Margin : 0
EUT : Network Camera	Probe : TESEQ_T8 - Line1
Power : By POE	Note : Mode 1, ISN 100M

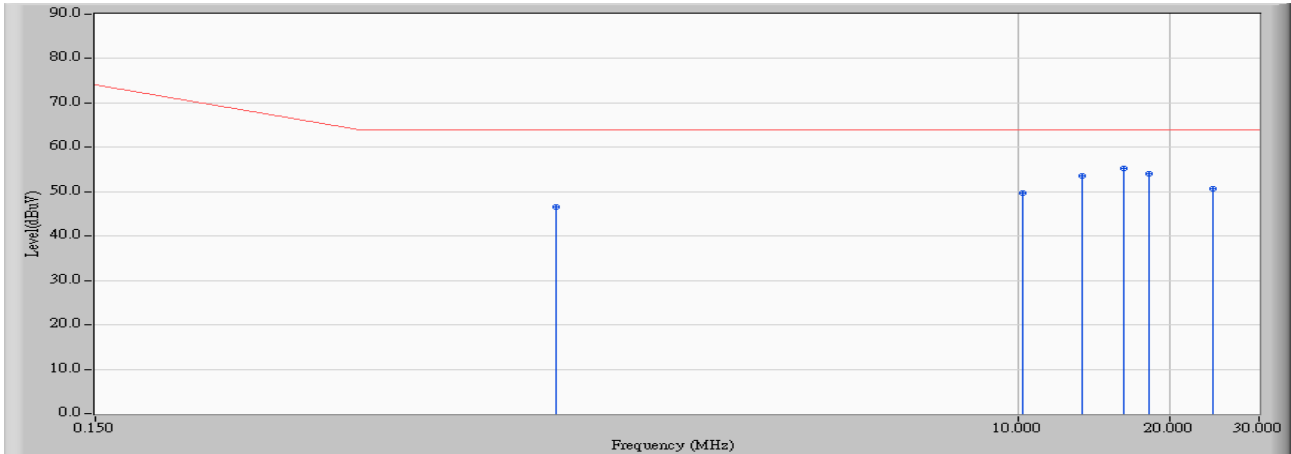

		Frequency (MHz)	Correct Factor (dB)	Reading Level (dBuV)	Measure Level (dBuV)	Margin (dB)	Limit (dBuV)	Detector Type
1		1.220	9.990	36.650	46.640	-17.360	64.000	AVERAGE
2		10.244	9.966	39.690	49.656	-14.344	64.000	AVERAGE
3		13.420	10.034	43.450	53.484	-10.516	64.000	AVERAGE
4	*	16.228	10.090	45.150	55.240	-8.760	64.000	AVERAGE
5		18.244	10.130	43.870	54.000	-10.000	64.000	AVERAGE
6		24.349	10.262	40.340	50.602	-13.398	64.000	AVERAGE

**Note:**

1. All Reading Levels are Quasi-Peak and average value.
2. " \* ", means this data is the worst emission level.
3. Measurement Level = Reading Level + Correct Factor

### 3.7. Test Photograph

Test Mode : Mode 1: POE Mode

Description : Front View of ISN Test



Test Mode : Mode 1: POE Mode

Description : Back View of ISN Test



## 4. Radiated Emission

### 4.1. Test Specification

According to EMC Standard : EN 55022

### 4.2. Test Setup

Under 1GHz Test Setup:

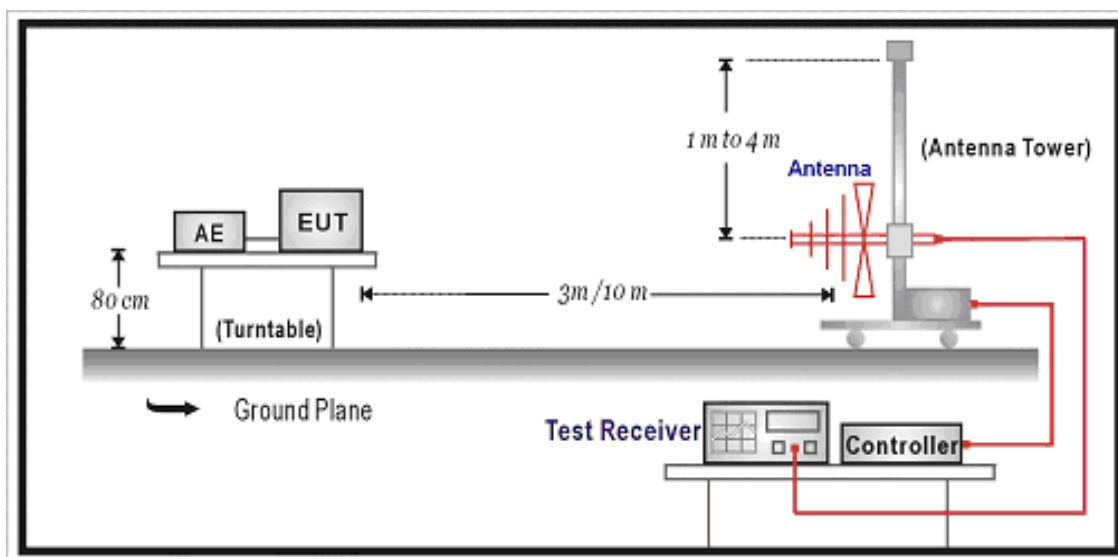

Above 1GHz Test Setup:

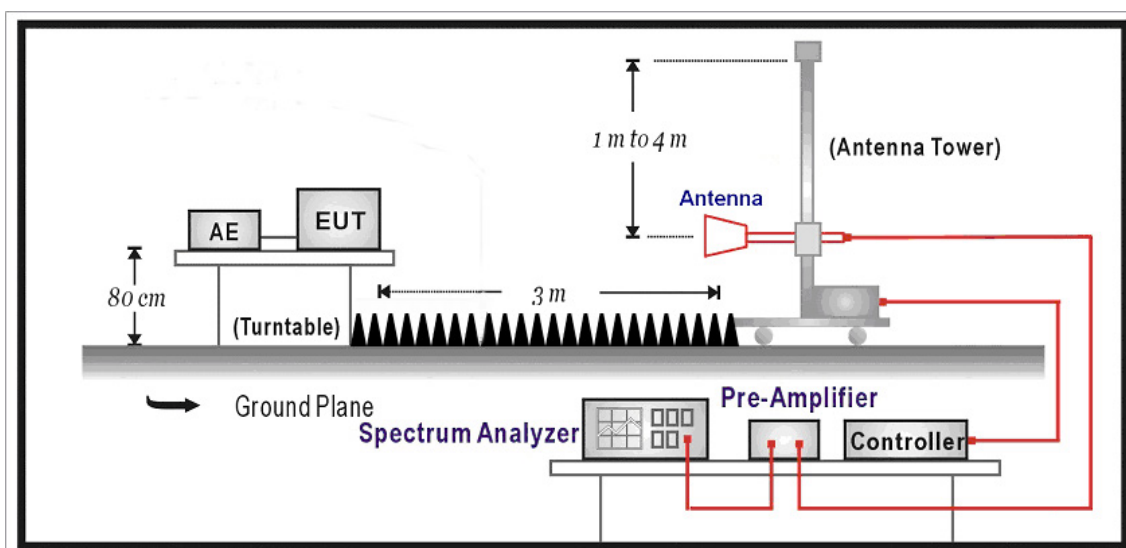

**4.3. Limit**

Limits		
Frequency (MHz)	Distance (m)	dBuV/m
30 – 230	10	30
230 – 1000	10	37

Limits			
Frequency (GHz)	Distance (m)	Peak (dBuV/m)	Average (dBuV/m)
1 – 3	3	70	50
3 – 6	3	74	54

Remark:

1. The tighter limit shall apply at the edge between two frequency bands.
2. Distance refers to the distance in meters between the measuring instrument antenna and the closed point of any part of the device or system.

Highest frequency generated or used in the device or on which the device operates or tunes (MHz)	Upper frequency of measurement range (MHz)
Below 108	1000
108 – 500	2000
500 – 1000	5000
Above 1000	5 <sup>th</sup> harmonic of the highest frequency or 6 GHz, whichever is lower

#### **4.4. Test Procedure**

The EUT and its simulators are placed on a turn table which is 0.8 meter above ground. The turn table can rotate 360 degrees to determine the position of the maximum emission level. The EUT was positioned such that the distance from antenna to the EUT was 3/10 meters. The antenna can move up and down between 1 meter and 4 meters to find out the maximum emission level.

Both horizontal and vertical polarization of the antenna are set on measurement. In order to find the maximum emission, all of the interface cables must be manipulated on radiated measurement.

Radiated emissions were investigated over the frequency range from 30MHz to 1GHz using a receiver bandwidth of 120kHz and above 1GHz using a receiver bandwidth of 1MHz.

30MHz to 1GHz Radiated was performed at an antenna to EUT distance of 10 meters.

Above 1GHz Radiated was performed at an antenna to EUT distance of 3 meters.

It is placed with absorb on the ground between EUT and Antenna.

#### **4.5. Deviation from Test Standard**

No deviation.



4.6. Test Result

Site : Site7	Time : 2012/09/28 - 10:36
Limit : CISPR_B_10M_QP	Margin : 6
EUT : Network Camera	Probe : Site7_CBL6112_10M_1207 - HORIZONTAL
Power : By POE	Note : Mode 1

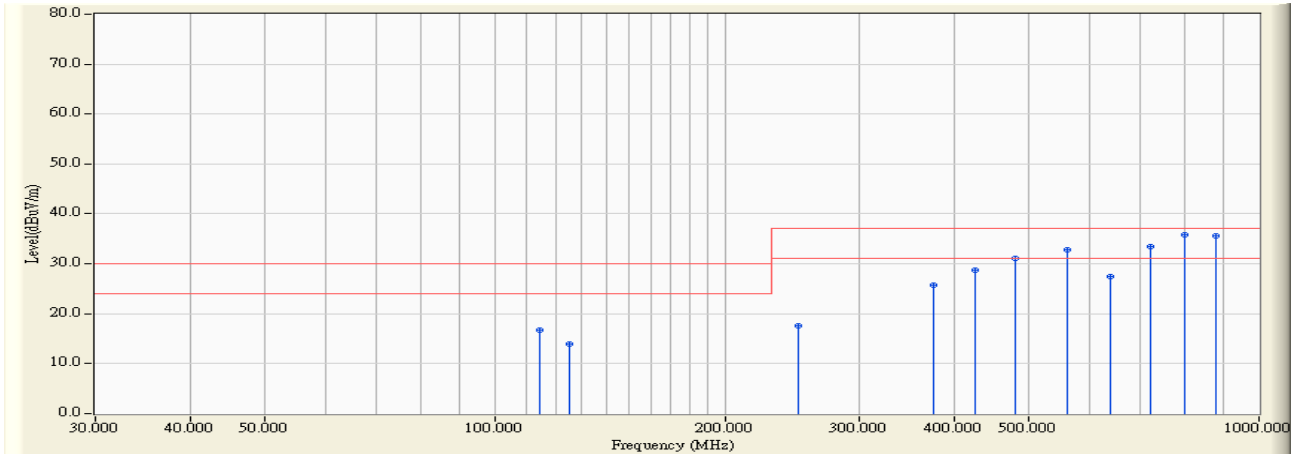

	Frequency (MHz)	Correct Factor (dB)	Reading Level (dBuV)	Measure Level (dBuV/m)	Margin (dB)	Limit (dBuV/m)	Detector Type
1	114.440	-18.517	35.300	16.782	-13.218	30.000	QUASPEAK
2	125.000	-18.399	32.400	14.001	-15.999	30.000	QUASPEAK
3	250.000	-16.104	33.600	17.496	-19.504	37.000	QUASPEAK
4	375.000	-12.226	37.900	25.674	-11.326	37.000	QUASPEAK
5	425.000	-10.444	39.200	28.756	-8.244	37.000	QUASPEAK
6	480.000	-9.102	40.300	31.198	-5.802	37.000	QUASPEAK
7	560.000	-7.080	39.800	32.720	-4.280	37.000	QUASPEAK
8	640.000	-6.082	33.600	27.517	-9.483	37.000	QUASPEAK
9	720.000	-4.943	38.500	33.557	-3.443	37.000	QUASPEAK
10	* 800.000	-3.902	39.800	35.898	-1.102	37.000	QUASPEAK
11	880.000	-2.700	38.200	35.500	-1.500	37.000	QUASPEAK

Note:

1. All Readings below 1GHz are Quasi-Peak, above are performed with peak and/or average measurements as necessary.
2. " \* ", means this data is the worst emission level.
3. Measurement Level = Reading Level + Correct Factor

Site : Site7	Time : 2012/09/28 - 10:13
Limit : CISPR_B_10M_QP	Margin : 6
EUT : Network Camera	Probe : Site7_CBL6112_10M_1207 - VERTICAL
Power : By POE	Note : Mode 1

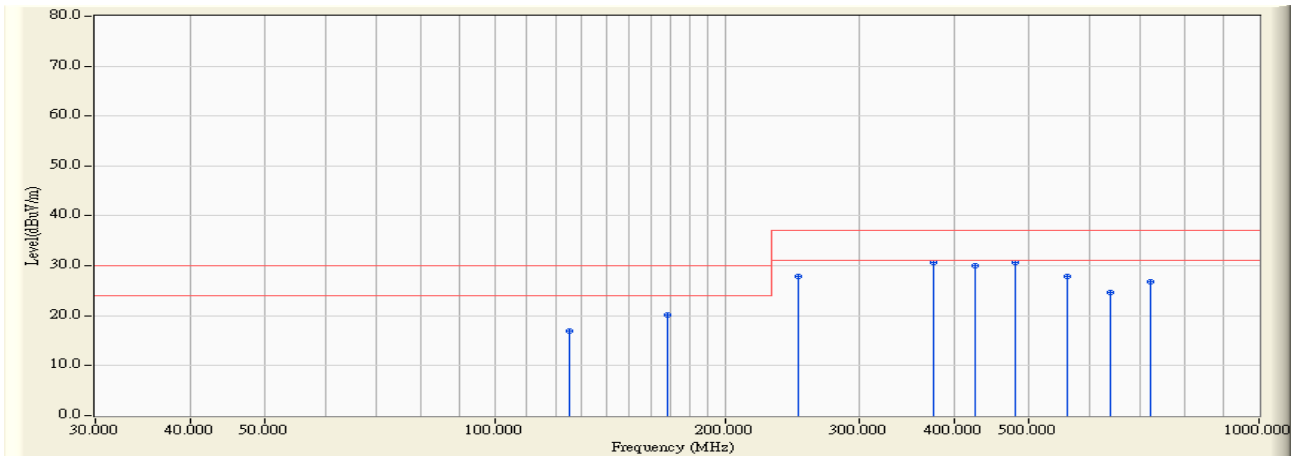

		Frequency (MHz)	Correct Factor (dB)	Reading Level (dBuV)	Measure Level (dBuV/m)	Margin (dB)	Limit (dBuV/m)	Detector Type
1		125.000	-18.399	35.400	17.001	-12.999	30.000	QUASIPeAK
2		168.500	-20.053	40.300	20.246	-9.754	30.000	QUASIPeAK
3		250.000	-16.104	44.000	27.896	-9.104	37.000	QUASIPeAK
4	*	375.000	-12.226	42.900	30.674	-6.326	37.000	QUASIPeAK
5		425.000	-10.444	40.500	30.056	-6.944	37.000	QUASIPeAK
6		480.000	-9.102	39.700	30.598	-6.402	37.000	QUASIPeAK
7		560.000	-7.080	35.000	27.920	-9.080	37.000	QUASIPeAK
8		640.000	-6.082	30.800	24.717	-12.283	37.000	QUASIPeAK
9		720.000	-4.943	31.800	26.857	-10.143	37.000	QUASIPeAK

**Note:**

1. All Readings below 1GHz are Quasi-Peak, above are performed with peak and/or average measurements as necessary.
2. " \* ", means this data is the worst emission level.
3. Measurement Level = Reading Level + Correct Factor

Site: CB7	Time: 2012/10/04 - 00:53
Limit: EN55022_B_(Above_1G)	Margin: 0
Probe: CB7_Horn_3117_1204	Polarity: Horizontal
EUT: Network Camera	Power: By POE
Note : Mode 1	

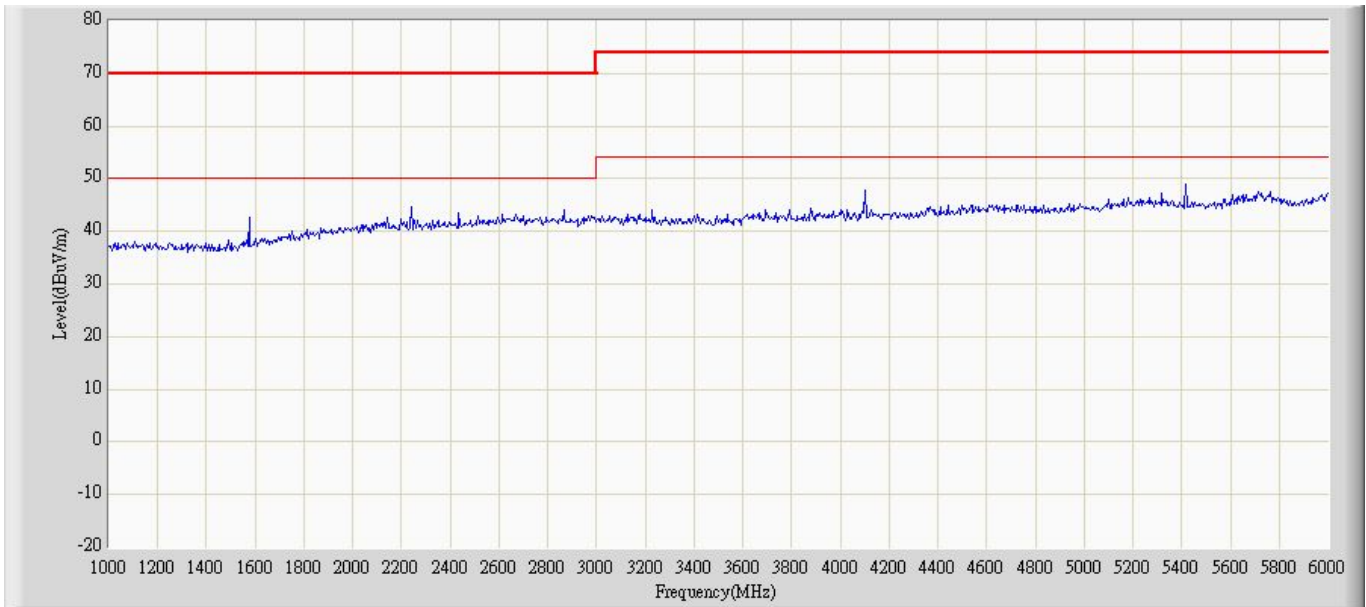

No	Flag	Mark	Frequency (MHz)	Measure Level (dBuV/m)	Reading Level (dBuV)	Over Limit (dB)	Limit (dBuV/m)	Factor	Type

Note:

1. All Readings below 1GHz are Quasi-Peak, above are performed with peak and/or average measurements as necessary.
2. " \* ", means this data is the worst emission level.
3. Measurement Level = Reading Level + Factor(Probe+Cable-Amp).

Site: CB7	Time: 2012/10/04 - 00:54
Limit: EN55022_B_(Above_1G)	Margin: 0
Probe: CB7_Horn_3117_1204	Polarity: Horizontal
EUT: Network Camera	Power: By POE
Note : Mode 1	

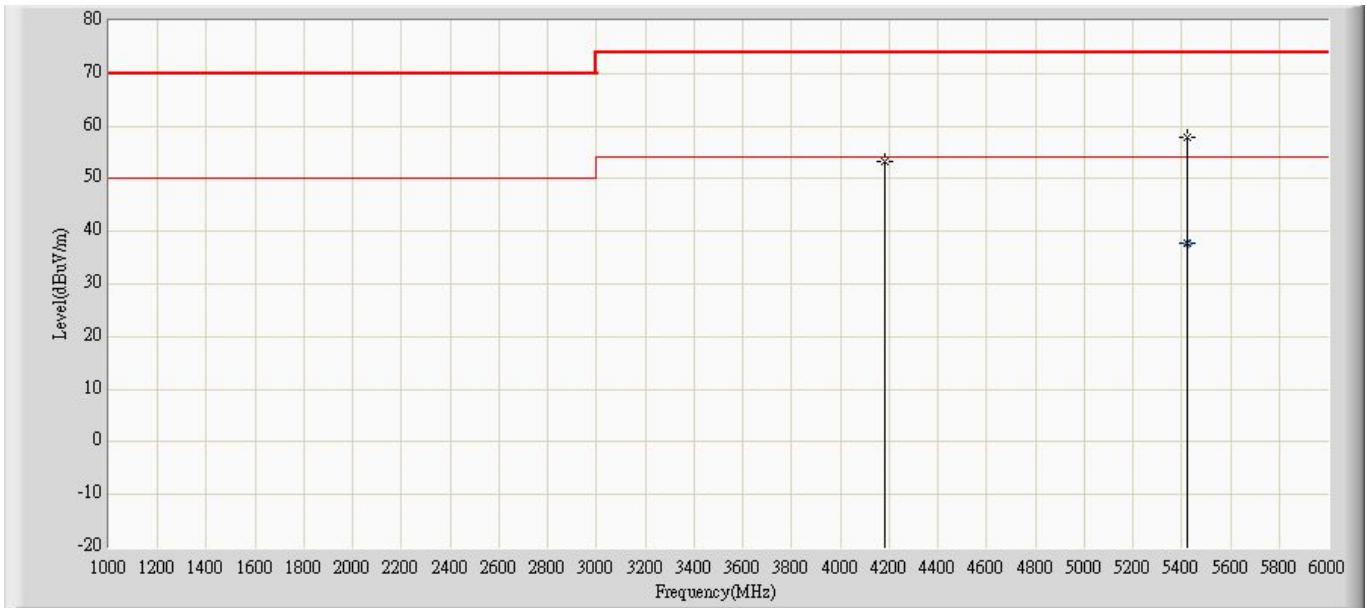

No	Flag	Mark	Frequency (MHz)	Measure Level (dBuV/m)	Reading Level (dBuV)	Over Limit (dB)	Limit (dBuV/m)	Factor	Type
1			4185.000	53.378	48.210	-20.622	74.000	5.168	PK
2		*	5425.000	57.943	50.360	-16.057	74.000	7.583	PK
3			5425.000	37.723	30.140	-16.277	54.000	7.583	AV

**Note:**

1. All Readings below 1GHz are Quasi-Peak, above are performed with peak and/or average measurements as necessary.
2. " \* ", means this data is the worst emission level.
3. Measurement Level = Reading Level + Factor(Probe+Cable-Amp).

Site: CB7	Time: 2012/10/04 - 00:56
Limit: EN55022_B_(Above_1G)	Margin: 0
Probe: CB7_Horn_3117_1204	Polarity: Vertical
EUT: Network Camera	Power: By POE
Note : Mode 1	

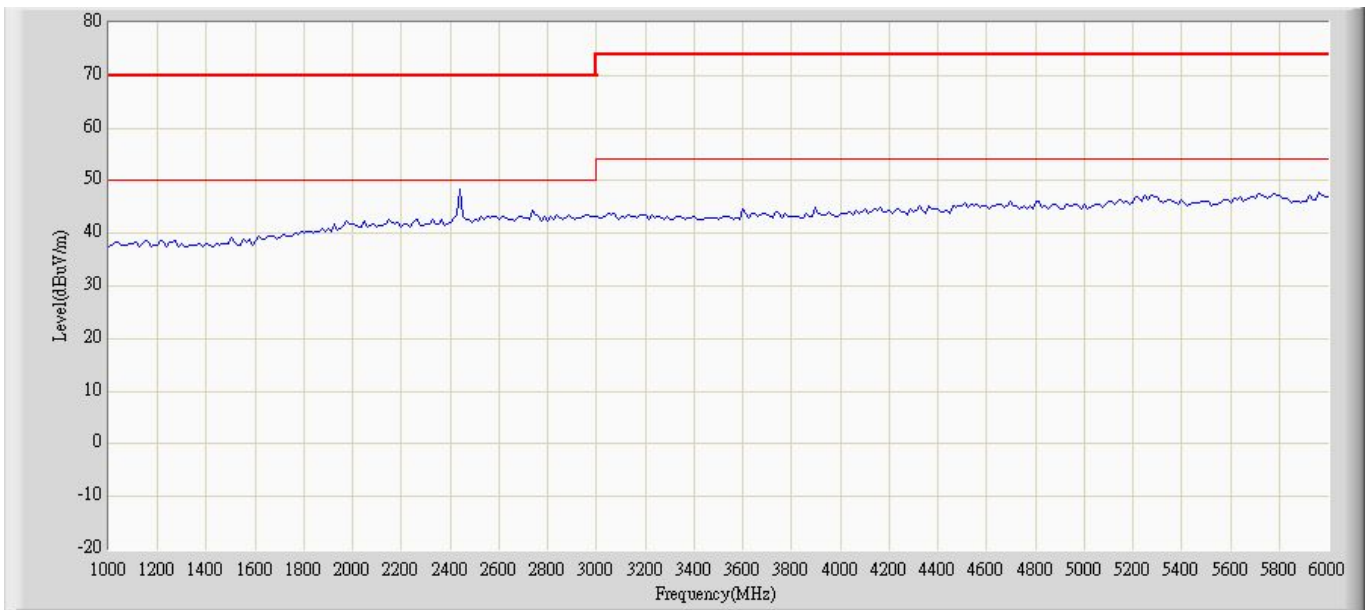

No	Flag	Mark	Frequency (MHz)	Measure Level (dBuV/m)	Reading Level (dBuV)	Over Limit (dB)	Limit (dBuV/m)	Factor	Type

Note:

1. All Readings below 1GHz are Quasi-Peak, above are performed with peak and/or average measurements as necessary.
2. " \* ", means this data is the worst emission level.
3. Measurement Level = Reading Level + Factor(Probe+Cable-Amp).

<b>Site: CB7</b>	<b>Time: 2012/10/04 - 00:59</b>
<b>Limit: EN55022_B_(Above_1G)</b>	<b>Margin: 0</b>
<b>Probe: CB7_Horn_3117_1204</b>	<b>Polarity: Vertical</b>
<b>EUT: Network Camera</b>	<b>Power: By POE</b>
<b>Note : Mode 1</b>	

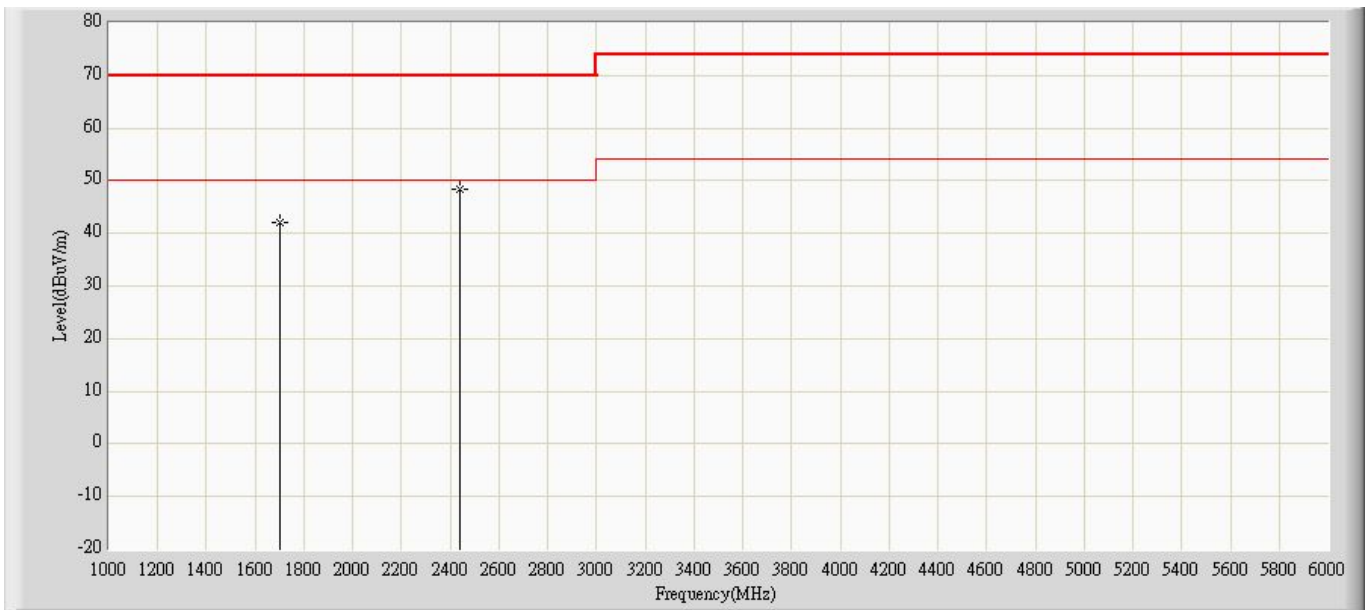

No	Flag	Mark	Frequency (MHz)	Measure Level (dBuV/m)	Reading Level (dBuV)	Over Limit (dB)	Limit (dBuV/m)	Factor	Type
1			1700.000	42.113	42.630	-27.887	70.000	-0.517	PK
2		*	2437.000	48.251	45.680	-21.749	70.000	2.571	PK

**Note:**

1. All Readings below 1GHz are Quasi-Peak, above are performed with peak and/or average measurements as necessary.
2. " \* ", means this data is the worst emission level.
3. Measurement Level = Reading Level + Factor(Probe+Cable-Amp).

**4.7. Test Photograph**

Test Mode : Mode 1: POE Mode

Description : Front View of Radiated Test



Test Mode : Mode 1: POE Mode

Description : Back View of Radiated Test



Test Mode : Mode 1: POE Mode

Description : Front View of High Frequency Radiated Test





## 5. Electrostatic Discharge

### 5.1. Test Specification

According to Standard : IEC 61000-4-2

### 5.2. Test Setup

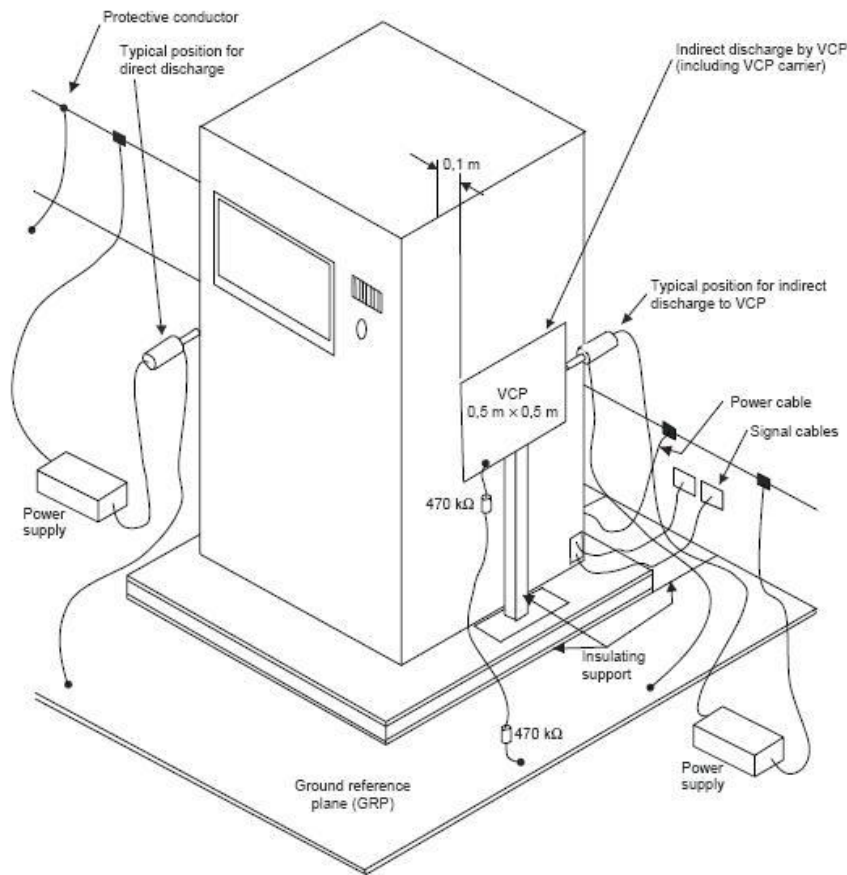

### 5.3. Limit

Test voltages <sup>1)</sup> :	Air discharges	(kV)	8
	Contact discharges	(kV)	6
Polarity			+ & -
Number of discharges per point for each voltage and polarity			10
Interval between discharges (s)			≥ 1
The test voltages specified are the open-circuit voltages. The test voltages for the lower severity levels are included because all the lower severity levels must also be satisfied.			

## 5.4. Test Procedure

Direct application of discharges to the EUT:

Contact discharge was applied only to conductive surfaces of the EUT.

Air discharges were applied only to non-conductive surfaces of the EUT.

During the test, it was performed with single discharges. For the single discharge time between successive single discharges will be keep longer 1 second. It was at least ten single discharges with positive and negative at the same selected point.

The selected point, which was performed with electrostatic discharge, was marked on the red label of the EUT.

Indirect application of discharges to the EUT:

Vertical Coupling Plane (VCP):

The coupling plane, of dimensions 0.5m x 0.5m, is placed parallel to, and positioned at a distance 0.1m from, the EUT, with the Discharge Electrode touching the coupling plane.

The four faces of the EUT will be performed with electrostatic discharge. It was at least ten single discharges with positive and negative at the same selected point.

Horizontal Coupling Plane (HCP):

The coupling plane is placed under to the EUT. The generator shall be positioned vertically at a distance of 0.1m from the EUT, with the Discharge Electrode touching the coupling plane.

The four faces of the EUT will be performed with electrostatic discharge. It was at least ten single discharges with positive and negative at the same selected point.

## 5.5. Deviation from Test Standard

No deviation.

**5.6. Test Result**

Product	Network Camera		
Test Item	Electrostatic Discharge		
Test Mode	Mode 1: POE Mode		
Date of Test	2012/10/08	Test Site	No.6 Shielded Room

Item	Amount of Discharge	Voltage	Required Criteria	Complied To Criteria (A,B,C)	Results
Air Discharge	10	+8kV	B	B	Pass
	10	-8kV	B	B	Pass
Contact Discharge	25	+4kV	B	B	Pass
	25	-4kV	B	B	Pass
Indirect Discharge (HCP)	25	+4kV	B	A	Pass
	25	-4kV	B	A	Pass
Indirect Discharge (VCP)	25	+4kV	B	A	Pass
	25	-4kV	B	A	Pass

Note:

The testing performed is from lowest level up to the highest level as required by standard, but only highest level is shown on the report.

NR: No Requirement

- Meet criteria A: Operate as intended during and after the test
- Meet criteria B: Operate as intended after the test
- Meet criteria C: Loss/Error of function
- Additional Information
  - EUT stopped operation and could / could not be reset by operator at \_\_\_\_ kV.
  - No false alarms or other malfunctions were observed during or after the test.

Remark:

The Contact discharges were applied at least total 200 discharges at a minimum of four test points.

## 5.7. Test Photograph

Test Mode : Mode 1: POE Mode

Description : ESD Test Setup



## 6. Radiated Susceptibility

### 6.1. Test Specification

According to Standard : IEC 61000-4-3

### 6.2. Test Setup

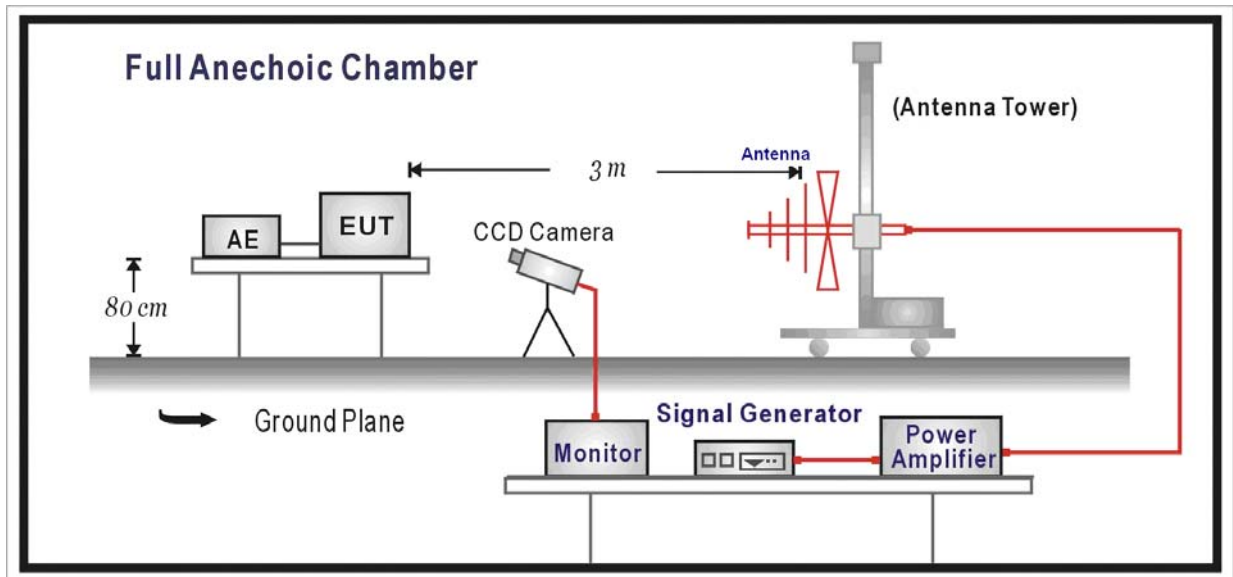

### 6.3. Limit

Item	Environmental Phenomena	Units	Test Specification	Performance Criteria
Enclosure Port				
	Radio-Frequency	MHz	80-1000	A
	Electromagnetic Field	V/m(Un-modulated, rms)	3	
	Amplitude Modulated	% AM (1kHz)	80	

#### 6.4. Test Procedure

The EUT and load, which are placed on a table that is 0.8 meter above ground, are placed with one coincident with the calibration plane such that the distance from antenna to the EUT was 3 meters.

Both horizontal and vertical polarization of the antenna and four sides of the EUT are set on measurement.

In order to judge the EUT performance, a CCD camera is used to monitor EUT screen.

All the scanning conditions are as follows:

Condition of Test	Remarks
1. Field Strength	3 V/m Level 2
2. Radiated Signal	AM 80% Modulated with 1kHz
3. Scanning Frequency	80MHz - 1000MHz
4. Dwell Time	3 Seconds
5. Frequency step size $\Delta f$ :	1%
6. The rate of Swept of Frequency	$1.5 \times 10^{-3}$ decades/s

#### 6.5. Deviation from Test Standard

No deviation.

6.6. Test Result

Product	Network Camera		
Test Item	Radiated susceptibility		
Test Mode	Mode 1: POE Mode		
Date of Test	2012/10/04	Test Site	Chamber5

Frequency (MHz)	Position (Angle)	Polarity (H or V)	Field Strength (V/m)	Required Criteria	Complied To Criteria (A,B,C)	Results
80-1000	0°	H	3	A	A	PASS
80-1000	0°	V	3	A	A	PASS
80-1000	90°	H	3	A	A	PASS
80-1000	90°	H	3	A	A	PASS
80-1000	180°	H	3	A	A	PASS
80-1000	180°	V	3	A	A	PASS
80-1000	270°	H	3	A	A	PASS
80-1000	270°	V	3	A	A	PASS

Note:

The testing performed is from lowest level up to the highest level as required by standard, but only highest level is shown on the report.

- Meet criteria A: Operate as intended during and after the test
- Meet criteria B: Operate as intended after the test
- Meet criteria C: Loss/Error of function
- Additional Information
  - There was no observable degradation in performance.
  - EUT stopped operation and could / could not be reset by operator at \_\_\_\_\_ V/m at frequency \_\_\_\_\_MHz.
- No false alarms or other malfunctions were observed during or after the test.

## 6.7. Test Photograph

Test Mode : Mode 1: POE Mode

Description : Radiated Susceptibility Test Setup

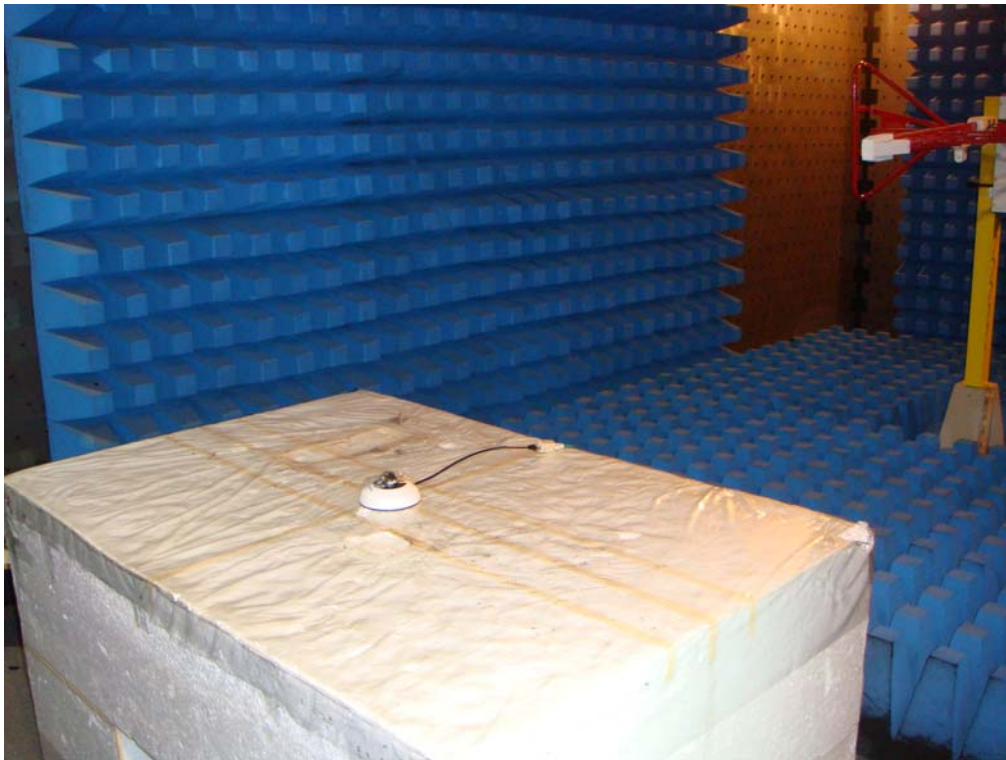

Test Mode : Mode 1: POE Mode

Description : Radiated Susceptibility Test Setup

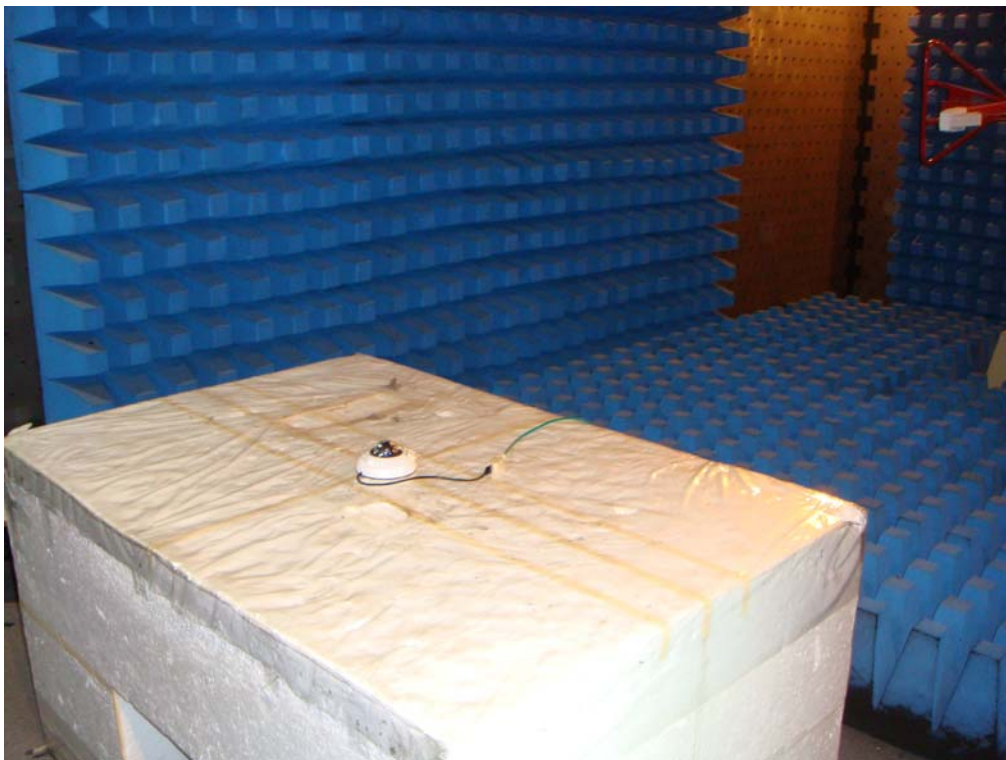



Test Mode : Mode 1: POE Mode  
Description : Radiated Susceptibility Test Setup

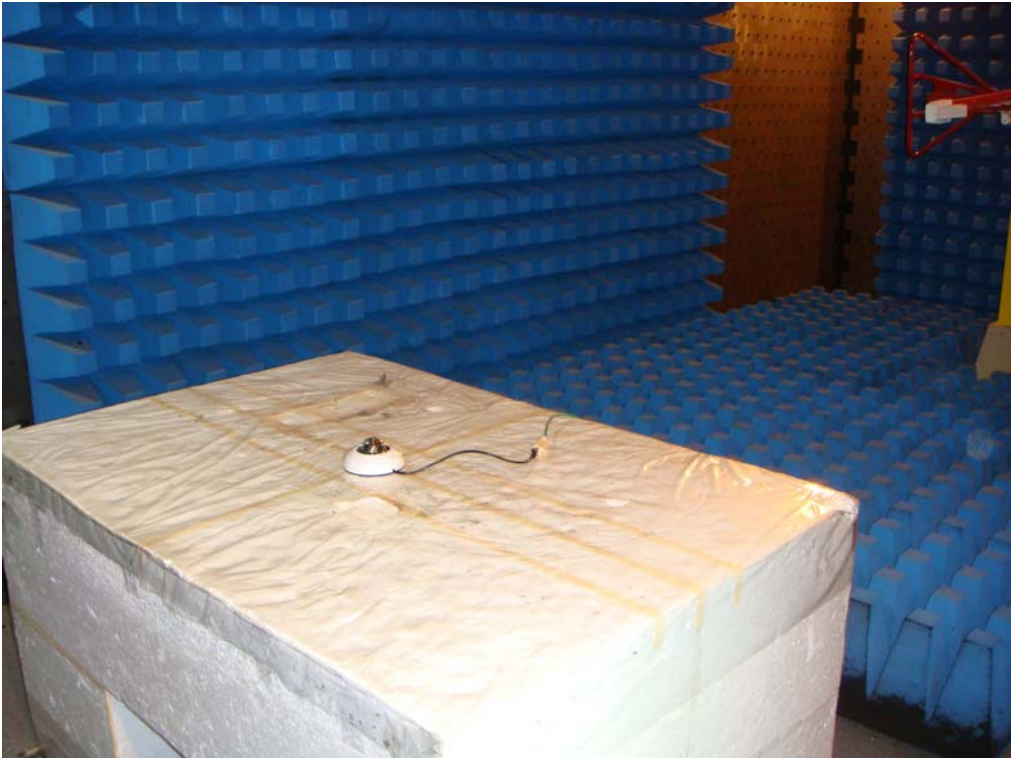

Test Mode : Mode 1: POE Mode  
Description : Radiated Susceptibility Test Setup

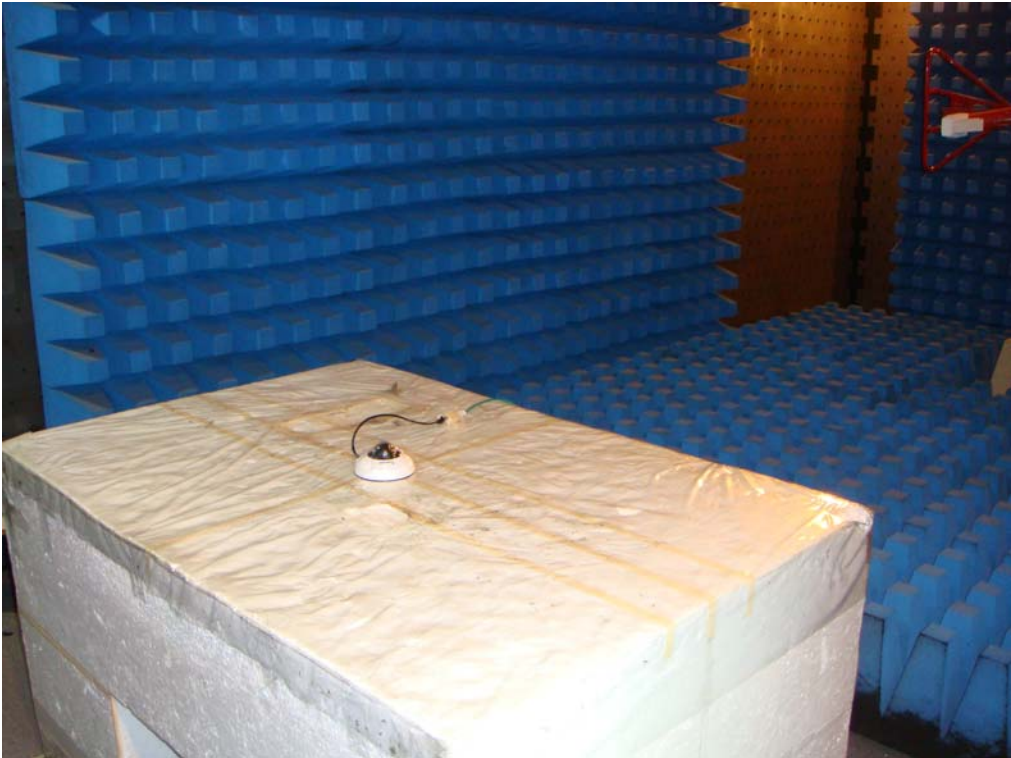

Test Mode : Mode 1: POE Mode

Description : Radiated Susceptibility Test Setup

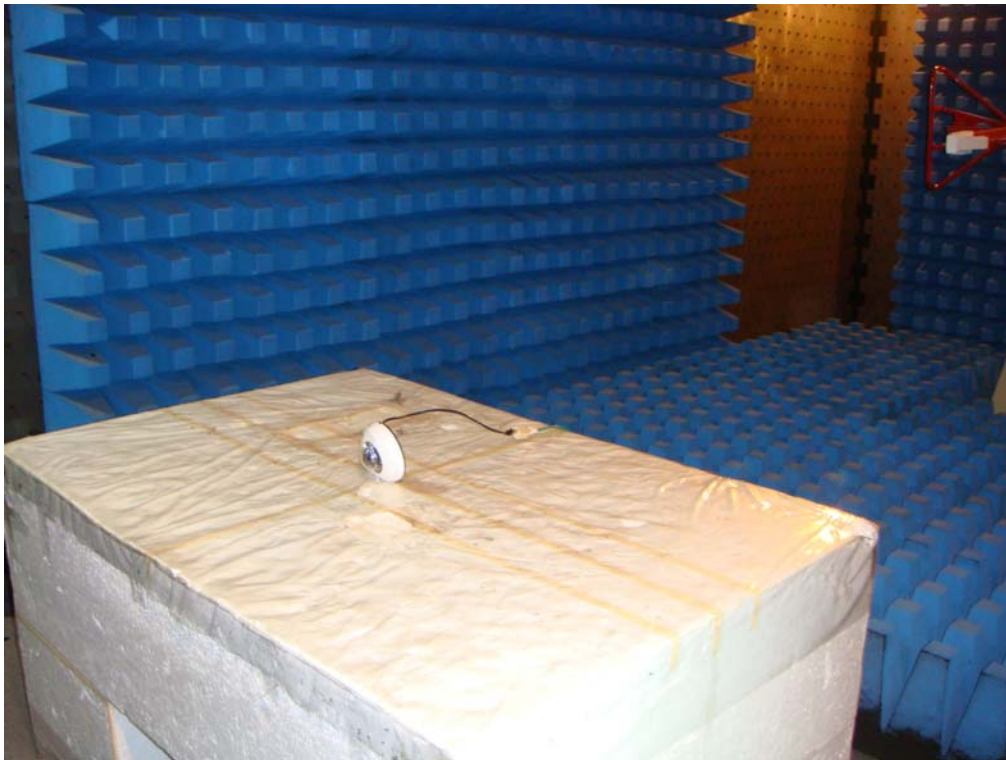

Test Mode : Mode 1: POE Mode

Description : Radiated Susceptibility Test Setup

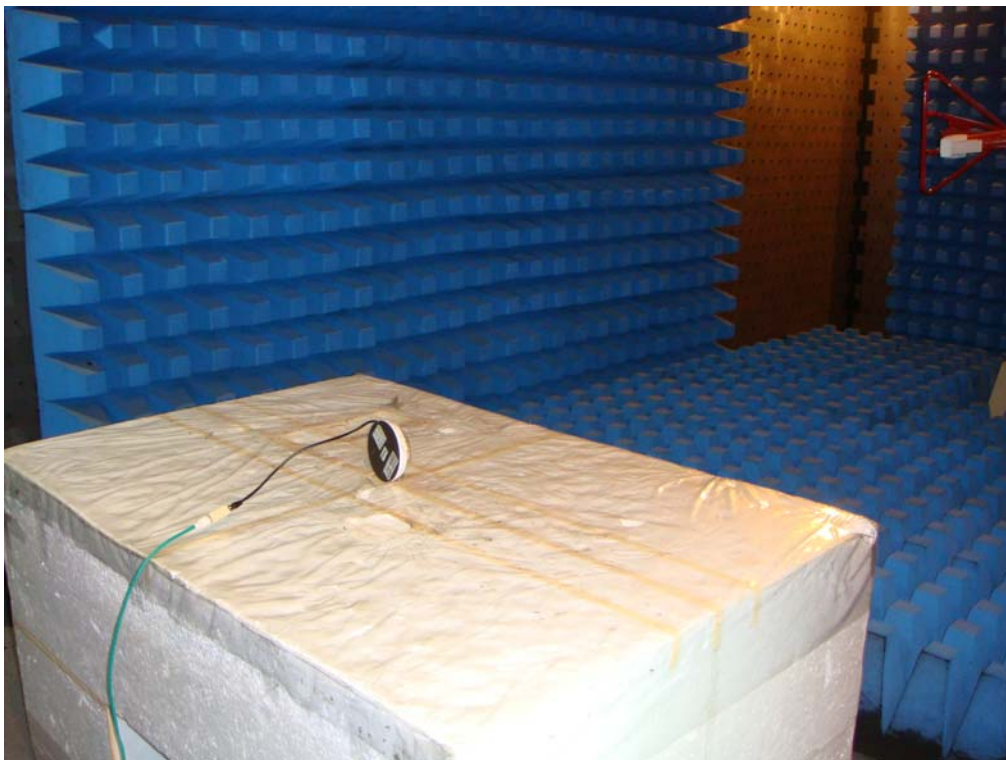

## 7. Electrical Fast Transient/Burst

### 7.1. Test Specification

According to Standard : IEC 61000-4-4

### 7.2. Test Setup

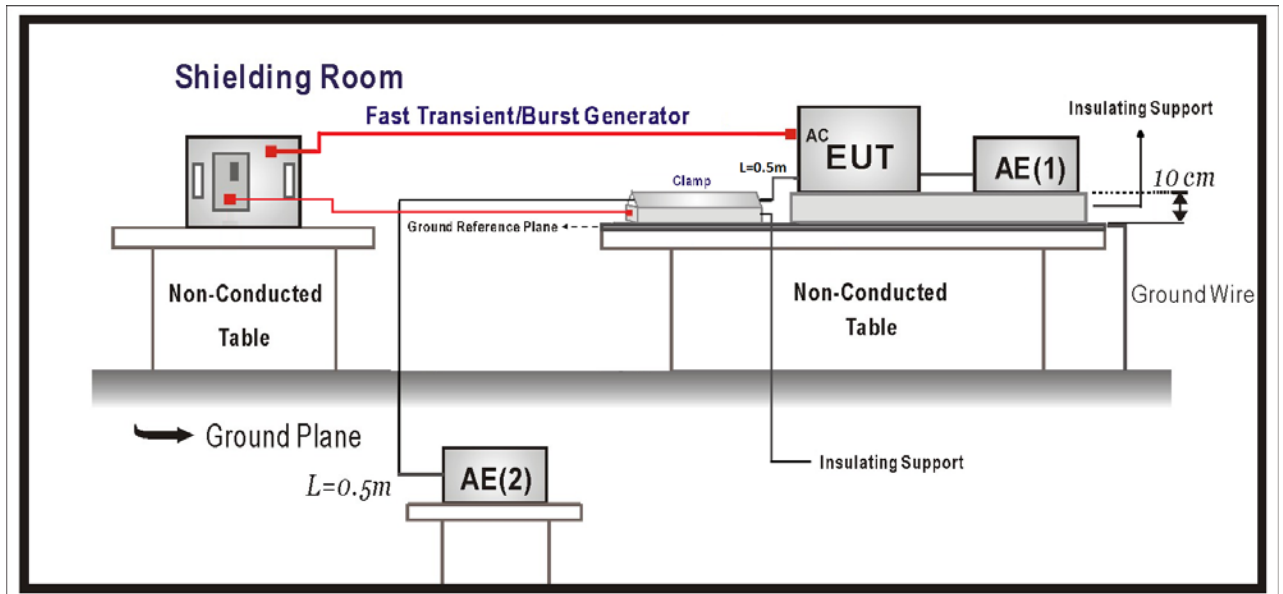

### 7.3. Limit

Item	Environmental Phenomena	Units	Test Specification	Performance Criteria
I/O and communication ports				
	Fast Transients Common Mode	kV (Peak) Tr/Th ns Rep. Frequency kHz	$\pm 0.5$ 5/50 5	B
Input DC Power Ports				
	Fast Transients Common Mode	kV (Peak) Tr/Th ns Rep. Frequency kHz	$\pm 0.5$ 5/50 5	B
Input AC Power Ports				
	Fast Transients Common Mode	kV (Peak) Tr/Th ns Rep. Frequency kHz	$\pm 1$ 5/50 5	B

#### **7.4. Test Procedure**

The EUT is placed on a table that is 0.8 meter height. A ground reference plane is placed on the table, and uses a 0.1m insulation between the EUT and ground reference plane.

The minimum area of the ground reference plane is 1m\*1m, and 0.65mm thick min, and projected beyond the EUT by at least 0.1m on all sides.

Test on I/O and communication ports:

The EFT interference signal is through a coupling clamp device couples to the signal and control lines of the EUT with burst noise for 1 minute.

Test on power supply ports:

The EUT is connected to the power mains through a coupling device that directly couples the EFT/B interference signal.

Each of the Line and Neutral conductors is impressed with burst noise for 1 minute.

The length of the signal and power lines between the coupling device and the EUT is 0.5m.

#### **7.5. Deviation from Test Standard**

No deviation.

**7.6. Test Result**

Product	Network Camera		
Test Item	Electrical fast transient/burst		
Test Mode	Mode 1: POE Mode		
Date of Test	2012/10/04	Test Site	No.3 Shielded Room

Inject Line	Polarity	Voltage kV	Inject Time (Second)	Inject Method	Required Criteria	Complied to Criteria	Result
LAN	±	0.5 kV	60	Clamp	B	B	PASS

**Note:**

The testing performed is from lowest level up to the highest level as required by standard, but only highest level is shown on the report.

- Meet criteria A : Operate as intended during and after the test
- Meet criteria B : Operate as intended after the test
- Meet criteria C : Loss/Error of function
- Additional Information
  - EUT stopped operation and could / could not be reset by operator at \_\_\_\_\_ kV of Line \_\_\_\_\_.
- No false alarms or other malfunctions were observed during or after the test.

## 7.7. Test Photograph

Test Mode : Mode 1: POE Mode

Description : EFT/B Test Setup-Clamp



8. Surge

8.1. Test Specification

According to Standard : IEC 61000-4-5

8.2. Test Setup

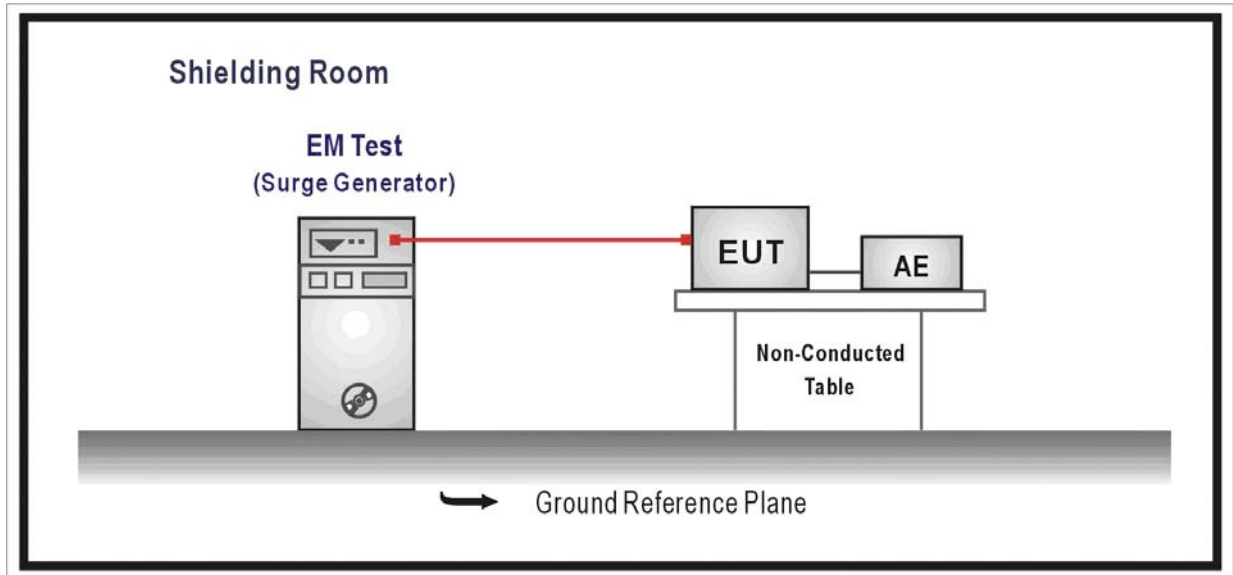

8.3. Limit

Item	Environmental Phenomena	Units	Test Specification	Performance Criteria
Signal Ports and Telecommunication Ports(See 1) and 2) )				
	Surges Line to Ground	Tr/Th us kV	10/700 ± 1	C
Input DC Power Ports				
	Surges Line to Ground	Tr/Th us kV	1.2/50 (8/20) ± 0.5	B
AC Input and AC Output Power Ports				
	Surges Line to Line Line to Ground	Tr/Th us kV kV	1.2/50 (8/20) ± 1 ± 2	B

Notes:

- 1) Applicable only to ports which according to the manufacturer’s may directly to outdoor cables.
- 2) Where normal functioning cannot be achieved because of the impact of the CDN on the EUT, no immunity test shall be required.

#### **8.4. Test Procedure**

The EUT and its load are placed on a table that is 0.8 meter above a metal ground plane measured 1m\*1m min. and 0.65mm thick min. And projected beyond the EUT by at least 0.1m on all sides. The length of power cord between the coupling device and the EUT shall be 2m or less.

For Input and Output AC Power or DC Input and DC Output Power Ports:

The EUT is connected to the power mains through a coupling device that directly couples the Surge interference signal.

The surge noise shall be applied synchronized to the voltage phase at 0<sup>0</sup>, 90<sup>0</sup>, 180<sup>0</sup>, 270<sup>0</sup> and the peak value of the a.c. voltage wave. (Positive and negative)

Each of Line-Earth and Line-Line is impressed with a sequence of five surge voltages with interval of 1 min.

#### **8.5. Deviation from Test Standard**

No deviation.



## 8.6. Test Result

Product	Network Camera		
Test Item	Surge		
Test Mode	Mode 1: POE Mode		
Date of Test	2012/10/04	Test Site	No.3 Shielded Room

Inject Line	Polarity	Voltage kV	Angle	Time Interval (Second)	Inject Method	Required Criteria	Complied to Criteria	Result
LAN	±	1kV	--	60	Direct	C	A	PASS

**Note:**

The testing performed is from lowest level up to the highest level as required by standard, but only highest level is shown on the report.

- Meet criteria A : Operate as intended during and after the test
- Meet criteria B : Operate as intended after the test
- Meet criteria C : Loss/Error of function
- Additional Information
  - EUT stopped operation and could / could not be reset by operator at \_\_\_\_\_ kV of Line \_\_\_\_\_.
- No false alarms or other malfunctions were observed during or after the test.

## 8.7. Test Photograph

Test Mode : Mode 1: POE Mode

Description : SURGE Test Setup



## 9. Conducted Susceptibility

### 9.1. Test Specification

According to Standard : IEC 61000-4-6

### 9.2. Test Setup

CDN Inject Method

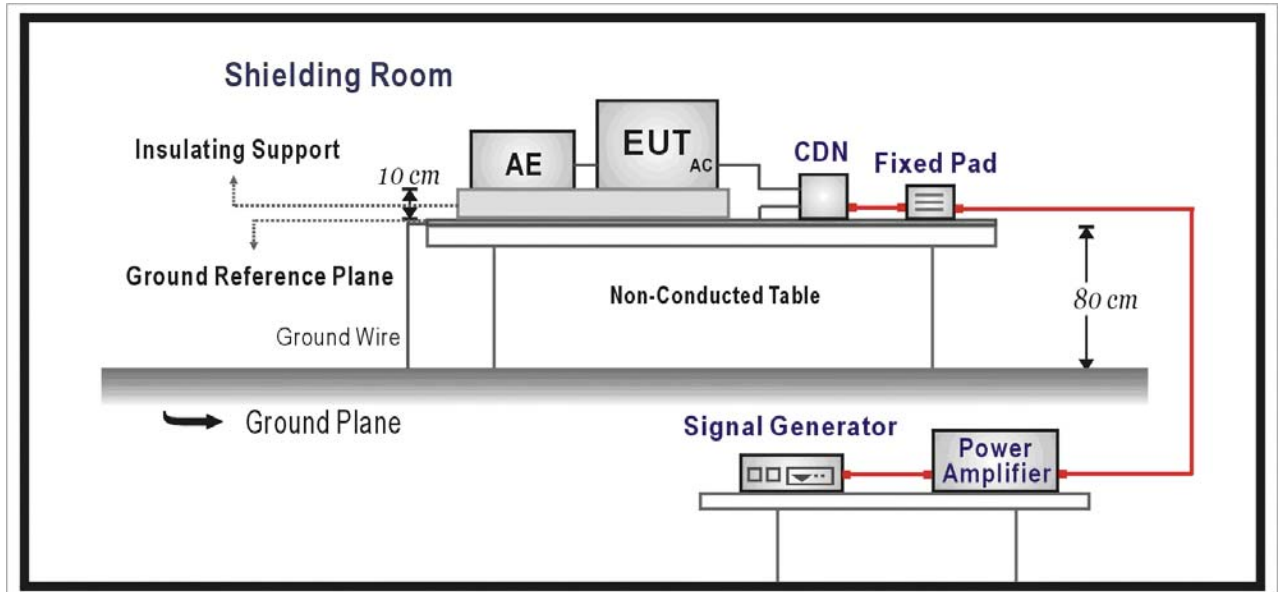

EM Clamp Inject Method

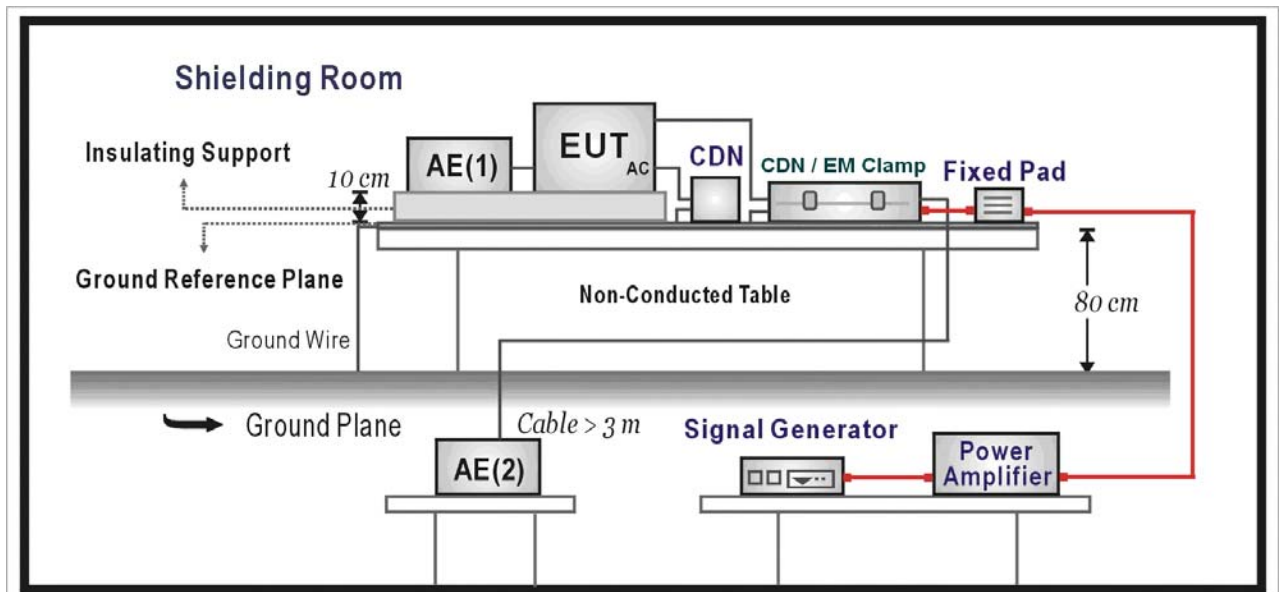

**9.3. Limit**

Item	Environmental Phenomena	Units	Test Specification	Performance Criteria
<b>Signal Ports and Telecommunication Ports</b>				
	Radio-Frequency Continuous Conducted	MHz V (rms, Un-modulated) % AM (1kHz)	0.15-80 3 80	A
<b>Input DC Power Ports</b>				
	Radio-Frequency Continuous Conducted	MHz V (rms, Un-modulated) % AM (1kHz)	0.15-80 3 80	A
<b>Input AC Power Ports</b>				
	Radio-Frequency Continuous Conducted	MHz V (rms, Un-modulated) % AM (1kHz)	0.15-80 3 80	A

**9.4. Test Procedure**

The EUT are placed on a table that is 0.8 meter height, and a Ground reference plane on the table, EUT are placed upon table and use a 10cm insulation between the EUT and Ground reference plane.

For Signal Ports and Telecommunication Ports

The disturbance signal is through a coupling and decoupling networks (CDN) or EM-clamp device couples to the signal and Telecommunication lines of the EUT.

For Input DC and AC Power Ports

The EUT is connected to the power mains through a coupling and decoupling networks for power supply lines. And directly couples the disturbances signal into EUT.

Used CDN-M2 for two wires or CDN-M3 for three wires.

All the scanning conditions are as follows:

Condition of Test	Remarks
1. Field Strength	130dBuV(3V) Level 2
2. Radiated Signal	AM 80% Modulated with 1kHz
3. Scanning Frequency	0.15MHz – 80MHz
4 Dwell Time	3 Seconds
5. Frequency step size $\Delta f$ :	1%
6. The rate of Swept of Frequency	$1.5 \times 10^{-3}$ decades/s

**9.5. Deviation from Test Standard**

No deviation.

**9.6. Test Result**

Product	Network Camera		
Test Item	Conducted susceptibility		
Test Mode	Mode 1: POE Mode		
Date of Test	2012/10/08	Test Site	No.6 Shielded Room

Frequency Range (MHz)	Voltage Applied dBuV(V)	Inject Method	Tested Port of EUT	Required Criteria	Performance Criteria Complied To	Result
0.15~80	130 (3V)	Clamp	LAN	A	A	PASS

**Note:**

The testing performed is from lowest level up to the highest level as required by standard, but only highest level is shown on the report.

- Meet criteria A : Operate as intended during and after the test
- Meet criteria B : Operate as intended after the test
- Meet criteria C : Loss/Error of function
- Additional Information
  - EUT stopped operation and could / could not be reset by operator at \_\_\_\_\_ dBuV(V) at frequency \_\_\_\_\_MHz.
  - No false alarms or other malfunctions were observed during or after the test. The acceptance criteria were met, and the EUT passed the test.

## 9.7. Test Photograph

Test Mode : Mode 1: POE Mode

Description : Conducted Susceptibility Test Setup - Clamp



**10. Power Frequency Magnetic Field**

**10.1. Test Specification**

According to Standard : IEC 61000-4-8

**10.2. Test Setup**

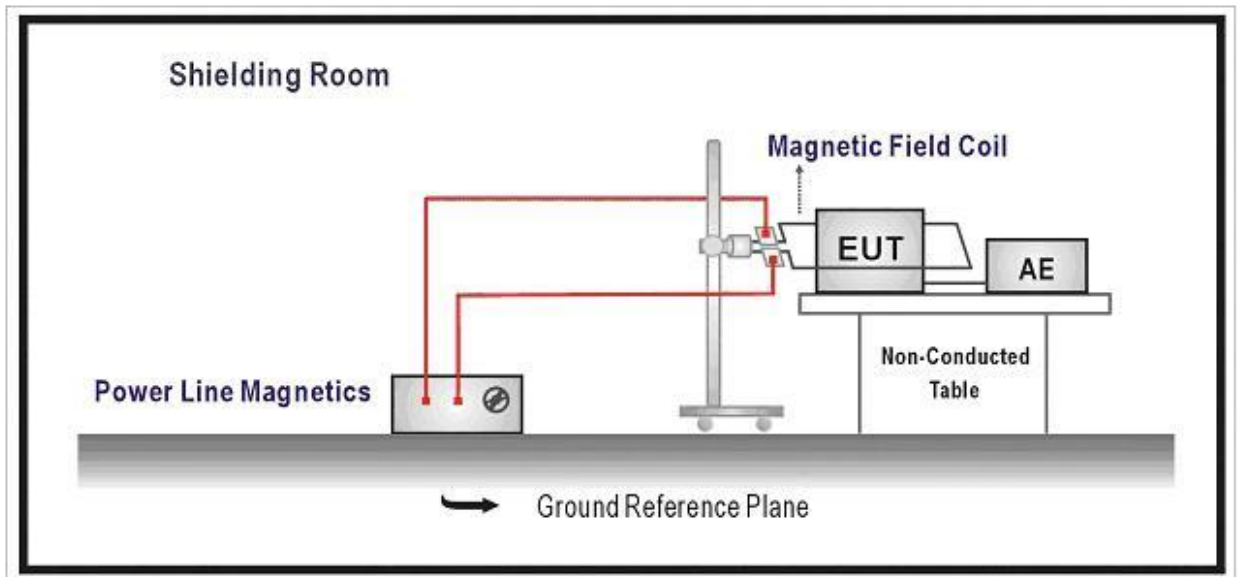

**10.3. Limit**

Item	Environmental Phenomena	Units	Test Specification	Performance Criteria
Enclosure Port				
	Power-Frequency Magnetic Field	Hz A/m (r.m.s.)	50 1	A

**10.4. Test Procedure**

The EUT and its load are placed on a table which is 0.8 meter above a metal ground plane measured at least 1m\*1m min. The test magnetic field shall be placed at central of the induction coil.

The test magnetic Field shall be applied 10 minutes by the immersion method to the EUT. And the induction coil shall be rotated by 90° in order to expose the EUT to the test field with different orientation (X, Y, Z Orientations).

**10.5. Deviation from Test Standard**

No deviation.

**10.6. Test Result**

Product	Network Camera		
Test Item	Power frequency magnetic field		
Test Mode	Mode 1: POE Mode		
Date of Test	2012/10/04	Test Site	No.3 Shielded Room

Polarization	Frequency (Hz)	Magnetic Strength (A/m)	Required Performance Criteria	Performance Criteria Complied To	Test Result
X Orientation	50	1	A	A	PASS
Y Orientation	50	1	A	A	PASS
Z Orientation	50	1	A	A	PASS

- Meet criteria A: Operate as intended during and after the test
- Meet criteria B: Operate as intended after the test
- Meet criteria C: Loss/Error of function
- Additional Information
  - EUT stopped operation and could / could not be reset by operator at \_\_\_\_\_ kV of Line \_\_\_\_\_.
- No false alarms or other malfunctions were observed during or after the test. The acceptance criteria were met, and the EUT passed the test.



## 10.7. Test Photograph

Test Mode : Mode 1: POE Mode

Description : Power Frequency Magnetic Field Test Setup



11. Attachment

➤ EUT Photograph

(1) EUT Photo



(2) EUT Photo



(3) EUT Photo

