



# FCC Verification TEST REPORT

According to

**47 CFR, Part 2, Part 15, CISPR PUB. 22,  
Canada ICES-003 Issue 5**

Applicant	: VIVOTEK INC.
Address	: 6F, No.192, Lien-Cheng Rd., Chung-Ho , New Taipei City, 235, Taiwan, R.O.C.
Equipment	: Network Camera
Model No.	: IP8364-C
Trade Name	: VIVOTEK

- The test result refers exclusively to the test presented test model / sample.
- Without written approval of **CerpPASS Technology Corp.** the test report shall not be reproduced except in full.



## Contents

<b>VERIFICATION OF COMPLIANCE .....</b>	<b>4</b>
<b>1. Summary of Test Procedure and Test Result.....</b>	<b>5</b>
<b>2. Test Configuration of Equipment under Test .....</b>	<b>6</b>
2.1. Feature of Equipment under Test.....	6
2.2. Test Manner .....	6
2.3. Description of Test System.....	6
2.4. General Information of Test.....	7
2.5. Measurement Uncertainty .....	7
<b>3. Test of Conducted Emission.....</b>	<b>8</b>
3.1. Test Limit .....	8
3.2. Test Procedures .....	8
3.3. Typical test Setup.....	9
3.4. Test Result and Data.....	9
<b>4. Test of Radiated Emission .....</b>	<b>10</b>
4.1. Test Limit .....	10
4.2. Test Procedures .....	10
4.3. Typical test Setup.....	11
4.4. Measurement Equipment.....	11
4.5. Test Result and Data (30MHz ~ 1GHz).....	12
4.6. Test Result and Data (1GHz ~ 18GHz).....	16
4.7. Test Photographs (30MHz~1GHz) .....	18
4.1. Test Photographs (1GHz~18GHz) .....	19
<b>Appendix A. Photographs of EUT.....</b>	<b>A1 ~ A6</b>



### History of this test report

ORIGINAL.

Additional attachment as following record:

Attachment No.	Issue Date	Description
TEFV1309159	Oct. 08, 2013	Original.



# VERIFICATION OF COMPLIANCE

According to  
**47 CFR, Part 2, Part 15, CISPR PUB. 22,  
Canada ICES-003 Issue 5**

Applicant : VIVOTEK INC.

Address : 6F, No.192, Lien-Cheng Rd., Chung-Ho ,  
New Taipei City, 235, Taiwan, R.O.C.

Equipment : Network Camera

Model No. : IP8364-C

## I HEREBY CERTIFY THAT :

The measurements shown in this test report were made in accordance with the procedures given in **ANSI C63.4 – 2009** and the energy emitted by this equipment was **passed CISPR PUB. 22 FCC Part 15, Canada ICES-003 Issue 5** in both radiated and conducted emission class B limits.

Testing was carried out on Oct. 04, 2013 at **CerpPASS Technology Corp.**

Signature

Hill Chen

EMC/RF B.U. Assistant Manager



### 1. Summary of Test Procedure and Test Result

Test Item	Normative References	Test Result
Conducted Emission	ANSI C63.4-2009 FCC Part 15 Subpart B Canada ICES-003 Issue 5	PASS
Radiated Emission	ANSI C63.4-2009 FCC Part 15 Subpart B Canada ICES-003 Issue 5	PASS



## 2. Test Configuration of Equipment under Test

### 2.1. Feature of Equipment under Test

Please refer to user's manual.

### 2.2. Test Manner

- a. During testing, the interface cables and equipment positions were varied according to ANSI C63.4.
- b. The complete test system included remote workstation, Micro SD Card, and EUT for EMC test. The remote workstation includes Notebook and PoE.
  - a. The test modes of radiation test as follow:  
Test Mode 1. Live View + Link LAN: 100Mbps, Power by PoE
- c. An executive program, "PING.EXE" under WIN 7 was executed to transmit and receive data to the remote workstation through LAN.



### 2.3. Description of Test System

Device	Manufacturer	Model No.	Description
Micro SD Card	SanDisk	2G	N/A
Remote workstation			
Notebook	SONY	PCG-71218P	Power Cable, Unshielding 1.8m
PoE	Part Target	F919I-48 10	Power Cable, Unshielding 1.8m

Use Cable:

Cable	Quantity	Description
RJ45	1	Unshielding, 15.0m

**2.4. General Information of Test**

Test Site :	Cerpass Technology Corp. 2F-11, No. 3, Yuan Qu St., (Nankang Software Park), Taipei, Taiwan 115, R.O.C.
Test Site Location (OATS2-SD) :	No.68-1, Shihbachongsi, Shihding Township, Taipei City 223, Taiwan, R.O.C.
FCC Registration Number :	TW1049, TW1056, TW1061, 390316, 488071, 982971
IC Registration Number :	4934B-1, 4934D-1
VCCI Registration Number :	T-1173 for Telecommunication Test C-4139 for Conducted emission test R-3428 for Radiated emission test G-97 for Radiated emission test above 1GHz
Frequency Range Investigated :	Conducted: from 150kHz to 30 MHz Radiation: from 30 MHz to 18,000 MHz
Test Distance :	The test distance of radiated emission below 1GHz from antenna to EUT is 10 M. The test distance of radiated emission above 1GHz from antenna to EUT is 3 M.
Laboratory Accreditation	 

**2.5. Measurement Uncertainty**

Measurement Item	Measurement Frequency	Polarization	Uncertainty
Conducted Emission	9 kHz ~ 30 MHz	LINE / NEUTRAL	3.25 dB
Radiated Emission	30 MHz ~ 1,000 MHz	Vertical / Horizontal	3.93 dB
	1,000 MHz ~ 15,000 MHz	Vertical / Horizontal	5.18 dB



### 3. Test of Conducted Emission

#### 3.1. Test Limit

Conducted Emissions were measured from 150 kHz to 30 MHz with a bandwidth of 9 KHz on the 120 VAC power and return leads of the EUT according to the methods defined in ANSI C63.4-2009 Section 3.1. The EUT was placed on a nonmetallic stand in a shielded room 0.8 meters above the ground plane as shown in section 1.2. The interface cables and equipment positioning were varied within limits of reasonable applications to determine the position produced maximum conducted emissions.

For a Class A digital device that is designed to be connected to the public utility (AC) power line, the radio frequency voltage that is conducted back onto the AC power line on any frequency or frequencies within the band 150 kHz to 30 MHz shall not exceed the limits in the following table, as measured using a 50  $\mu$ H/50 ohms LISN. Compliance with the provisions of this paragraph shall be based on the measurement of the radio frequency voltage between each power line and ground at the power terminal. The lower limit applies at the boundary between the frequency ranges.

Frequency (MHz)	Quasi Peak (dB $\mu$ V)	Average (dB $\mu$ V)
0.15 – 0.5	79	66
0.5 – 30.0	73	60

#### 3.2. Test Procedures

- The EUT was placed 0.4 meter from the conducting wall of the shielding room was kept at least 80 centimeters from any other grounded conducting surface.
- Connect EUT to the power mains through a line impedance stabilization network (LISN).
- All the support units are connecting to the other LISN.
- The LISN provides 50 ohm coupling impedance for the measuring instrument.
- The FCC states that a 50 ohm, 50 micro-Henry LISN should be used.
- Both sides of AC line were checked for maximum conducted interference.
- The frequency range from 150 kHz to 30 MHz was searched.
- Set the test-receiver system to Peak Detect Function and Specified Bandwidth with Maximum Hold Mode.





### 3.3. Typical test Setup

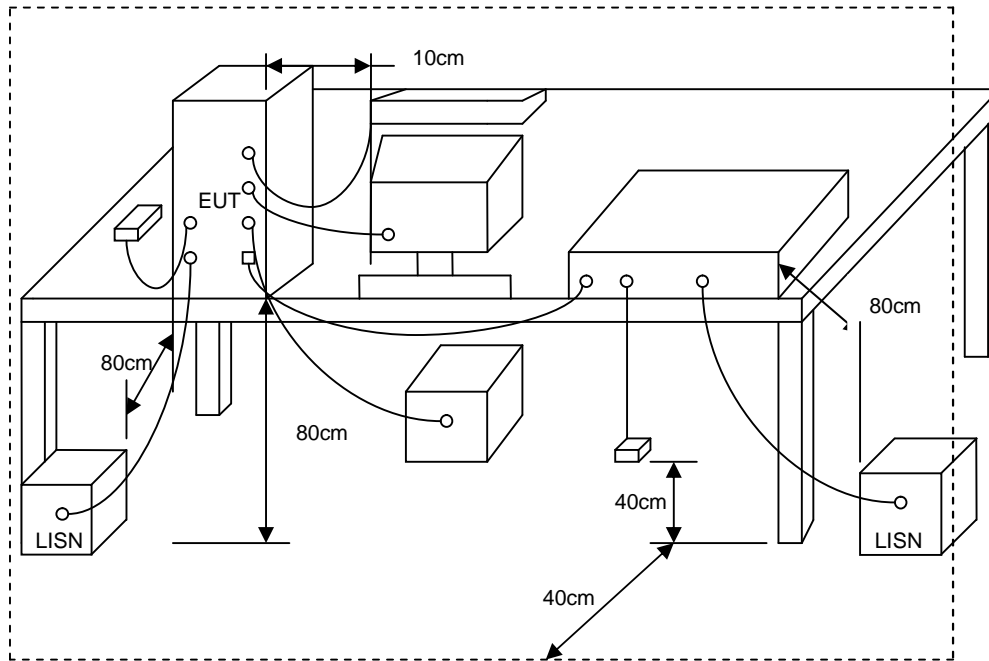

### 3.4. Test Result and Data

This test item is not applicable; the EUT is powered from PoE.



## 4. Test of Radiated Emission

### 4.1. Test Limit

The EUT was placed on a nonmetallic stand in the open-field site, 0.8 meter above the ground plane, as shown in section 2.2. The interface cables and equipment positions were varied within limits of reasonable applications to determine the positions producing maximum radiated emissions.

For unintentional device, according to § 15.109(b), for Class A digital devices, the field strength of radiated emissions from unintentional radiators at a distance of 10 meters shall not exceed the following values:

Frequency (MHz)	Distance Meters	Radiated ( $\mu$ V / M)	Radiated (dB $\mu$ V/ M)
30-88	10	90	39.0
88-216	10	150	43.5
216-960	10	210	46.4
Above 960	10	300	49.5

For unintentional device, according to CISPR PUB.22, for Class A digital devices, the general requirement of field strength of radiated emissions from intentional radiators at a distance of 10 meters shall not exceed the below table.

Frequency (MHz)	Distance Meters	Radiated (dB $\mu$ V/ M)
30-230	10	40
230-1000	10	47

### 4.2. Test Procedures

- The EUT was placed on a Rota table top 0.8 meter above ground.
- The EUT was set 3/10 meters from the interference receiving antenna which was mounted on the top of a variable height antenna tower.
- The table was rotated 360 degrees to determine the position of the highest radiation.
- The antenna is a half wave dipole and its height is varied between one meter and four meters above ground to find the maximum value of the field strength both horizontal polarization and vertical polarization of the antenna are set to make the measurement.
- For each suspected emission the EUT was arranged to its worst case and then tune the antenna tower (from 1 M to 4 M) and turn table (from 0 degree to 360 degrees) to find the maximum reading.
- Set the test-receiver system to Peak Detect Function and specified bandwidth with Maximum Hold Mode.
- If the emission level of the EUT in peak mode was 6 dB lower than the limit specified, then testing will be stopped and peak values of EUT will be reported, otherwise, the emissions which do not have 6 dB margin will be repeated one by one using the quasi-peak method and reported.



### 4.3. Typical test Setup

#### Below 1GHz Test Setup

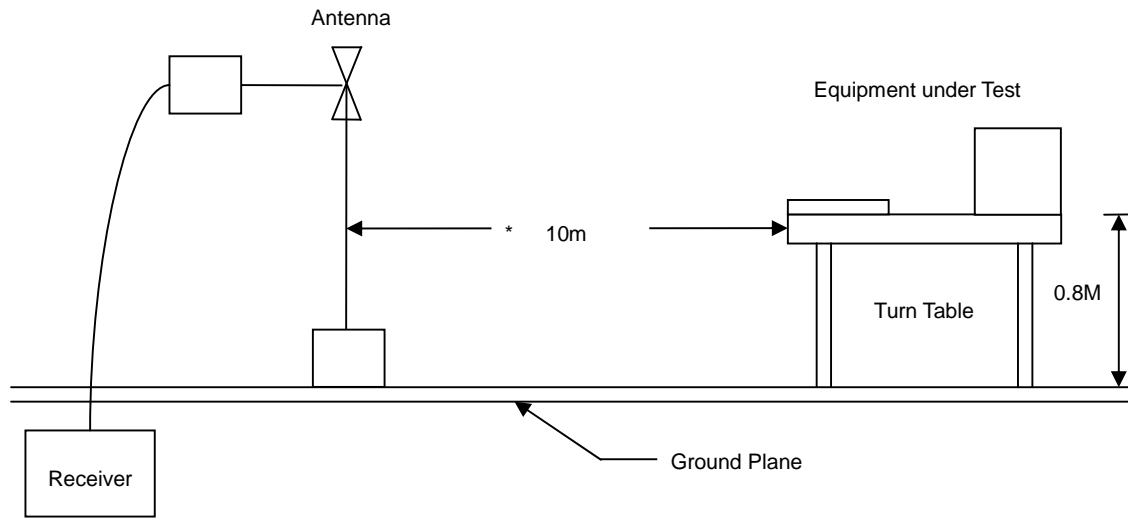

#### Above 1GHz Test Setup

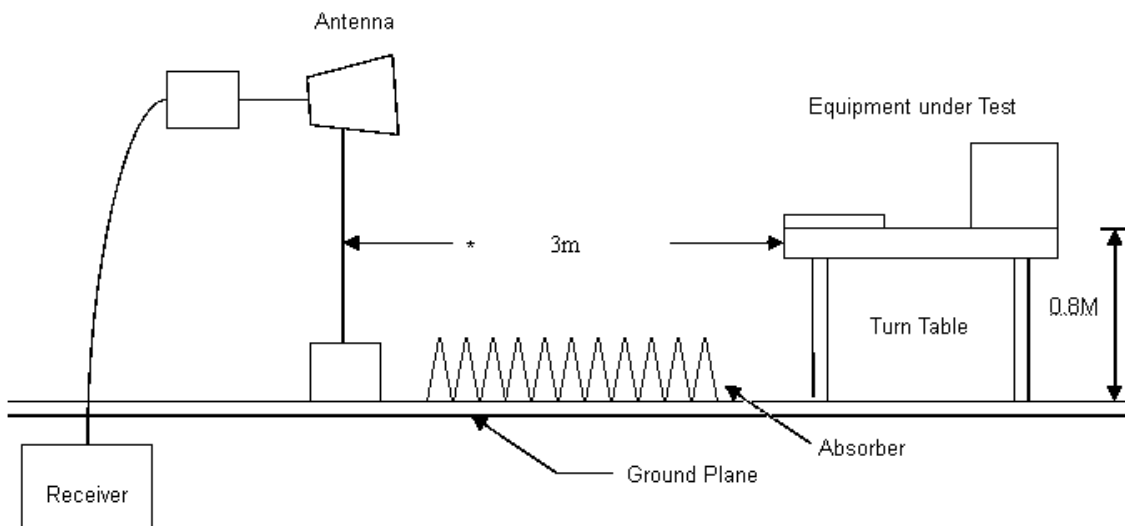

### 4.4. Measurement Equipment

Instrument	Manufacturer	Model No.	Serial No.	Calibration Date	Valid Date
Bilog Antenna	Sciences Corporation	JB1	A080713	2013/08/22	2014/08/21
Amplifier	AGILENT	8447D	2944A10531	2013/09/24	2015/09/23
EMI Receiver	R&S	ESCI	101200	2013/09/07	2014/09/06
SPECTRUM ANALYZER	R&S	FSP40	100219	2013/09/14	2014/09/13
HORN ANTENNA	EMCO	3115	31589	2013/03/18	2014/03/17
PREAMPLIFIER	AGILENT	8449B	3008A01954	2013/03/07	2014/03/06



### 4.5. Test Result and Data (30MHz ~ 1GHz)

Power	: PoE	Pol/Phase	: VERTICAL
Test Mode 1	: Live View + Link LAN: 100Mbps	Temperature	: 25 °C
Test Date	: Oct. 02, 2013	Humidity	: 69 %
Memo	:	Atmospheric Pressure	: 995 hpa

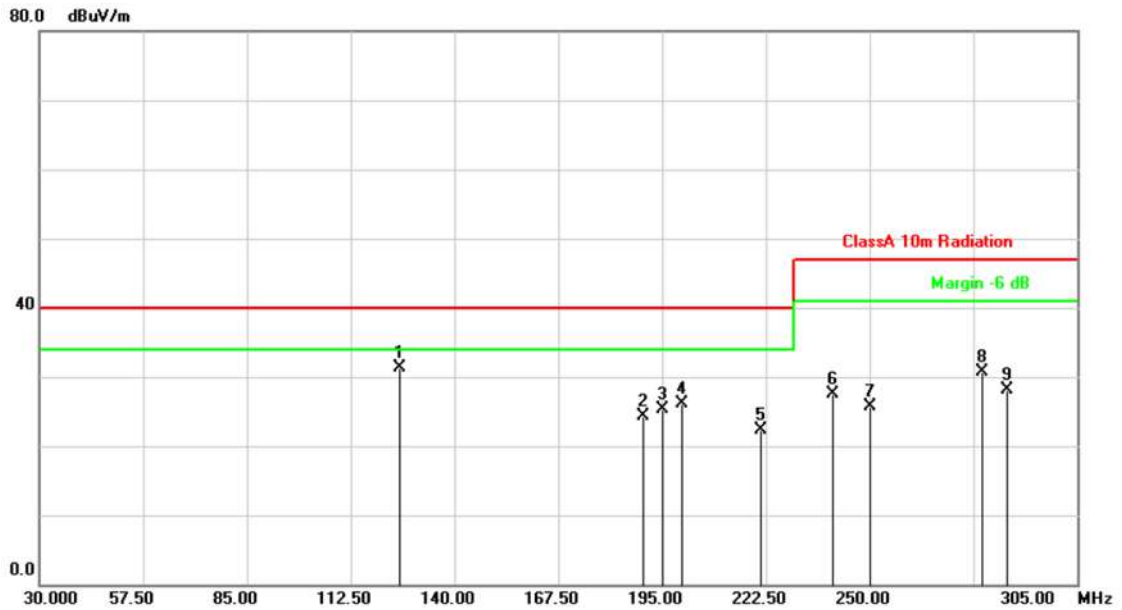

No.	Frequency (MHz)	Factor (dB/m)	Reading (dBuV)	Level (dBuV/m)	Limit (dBuV/m)	Margin (dB)	Detector	Height (cm)	Azimuth (°)	P/F
1	125.4250	-13.76	45.03	31.27	40.00	-8.73	QP	400	0	P
2	190.0500	-15.63	39.89	24.26	40.00	-15.74	QP	400	0	P
3	195.2750	-15.44	40.78	25.34	40.00	-14.66	QP	400	0	P
4	200.2250	-15.28	41.35	26.07	40.00	-13.93	QP	400	0	P
5	221.1250	-15.00	37.21	22.21	40.00	-17.79	QP	400	0	P
6	240.1000	-12.67	40.26	27.59	47.00	-19.41	QP	400	0	P
7	250.0000	-11.46	37.18	25.72	47.00	-21.28	QP	400	0	P
8	279.7000	-10.58	41.20	30.62	47.00	-16.38	QP	400	0	P
9	286.5750	-10.41	38.49	28.08	47.00	-18.92	QP	400	0	P

Note: Level = Reading + Factor  
Margin = Level – Limit



Power	: PoE	Pol/Phase	: VERTICAL
Test Mode 1	: Live View + Link LAN: 100Mbps	Temperature	: 25 °C
Test Date	: Oct. 02, 2013	Humidity	: 69 %
Memo	:	Atmospheric Pressure	: 995 hpa

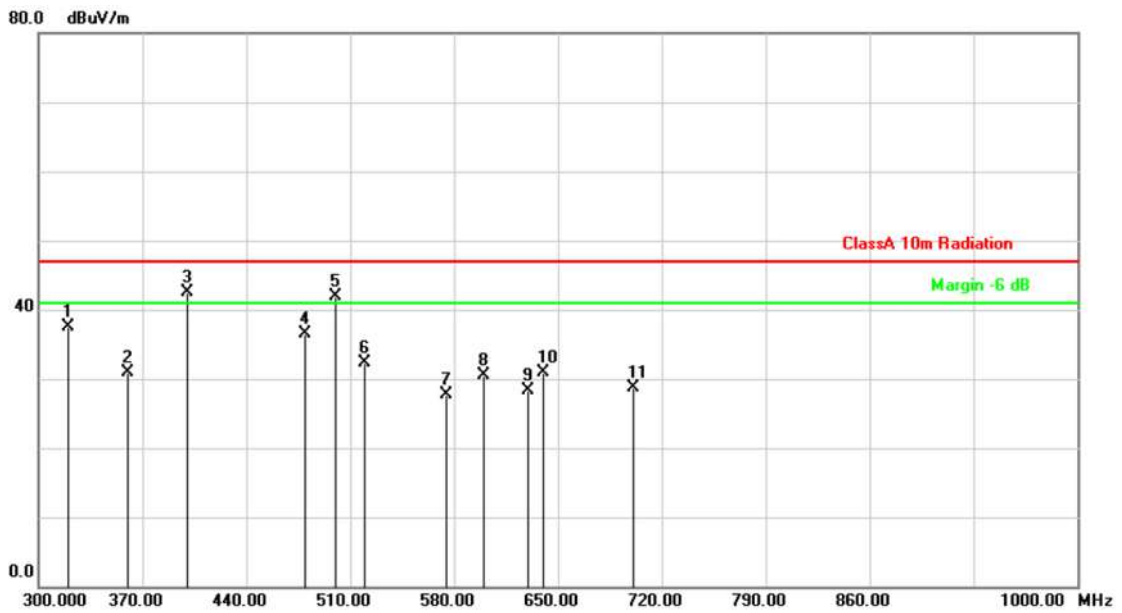

No.	Frequency (MHz)	Factor (dB/m)	Reading (dBuV)	Level (dBuV/m)	Limit (dBuV/m)	Margin (dB)	Detector	Height (cm)	Azimuth (°)	P/F
1	320.3000	-9.45	46.91	37.46	47.00	-9.54	QP	100	0	P
2	360.2000	-8.44	39.43	30.99	47.00	-16.01	QP	100	0	P
3	400.1000	-7.18	49.68	42.50	47.00	-4.50	QP	100	0	P
4	480.0000	-5.35	41.79	36.44	47.00	-10.56	QP	100	132	P
5	500.2000	-4.96	46.79	41.83	47.00	-5.17	QP	165	68	P
6	519.8000	-4.28	36.65	32.37	47.00	-14.63	QP	100	0	P
7	574.4000	-3.29	30.96	27.67	47.00	-19.33	QP	100	0	P
8	599.6000	-3.36	33.91	30.55	47.00	-16.45	QP	100	0	P
9	629.7000	-2.93	31.14	28.21	47.00	-18.79	QP	100	0	P
10	640.2000	-2.78	33.75	30.97	47.00	-16.03	QP	100	0	P
11	700.4000	-2.39	31.18	28.79	47.00	-18.21	QP	100	0	P

Note: Level = Reading + Factor  
Margin = Level – Limit



Power	: PoE	Pol/Phase	: HORIZONTAL
Test Mode 1	: Live View + Link LAN: 100Mbps	Temperature	: 25 °C
Test Date	: Oct. 02, 2013	Humidity	: 69 %
Memo	:	Atmospheric Pressure	: 995 hpa

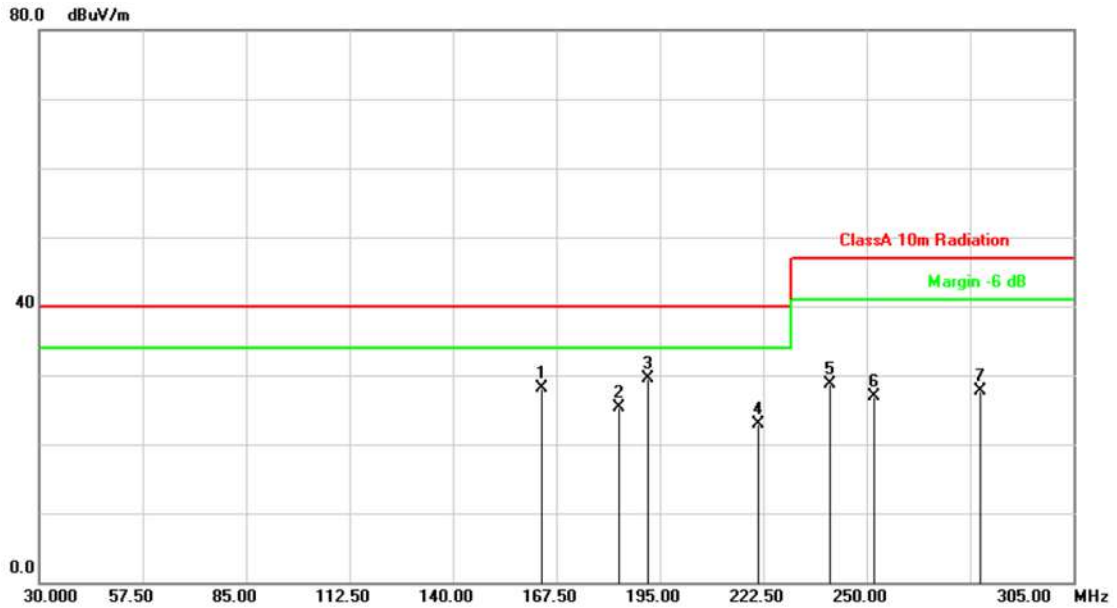

No.	Frequency (MHz)	Factor (dB/m)	Reading (dBuV)	Level (dBuV/m)	Limit (dBuV/m)	Margin (dB)	Detector	Height (cm)	Azimuth (°)	P/F
1	163.6500	-15.09	43.11	28.02	40.00	-11.98	QP	400	0	P
2	184.2750	-15.60	40.82	25.22	40.00	-14.78	QP	400	0	P
3	191.7000	-15.58	45.11	29.53	40.00	-10.47	QP	400	0	P
4	221.1250	-15.00	37.83	22.83	40.00	-17.17	QP	400	0	P
5	240.1000	-12.67	41.31	28.64	47.00	-18.36	QP	400	0	P
6	251.9250	-11.18	38.10	26.92	47.00	-20.08	QP	400	0	P
7	280.2500	-10.58	38.28	27.70	47.00	-19.30	QP	400	0	P

Note: Level = Reading + Factor  
Margin = Level – Limit



Power	: PoE	Pol/Phase	: HORIZONTAL
Test Mode 1	: Live View + Link LAN: 100Mbps	Temperature	: 25 °C
Test Date	: Oct. 02, 2013	Humidity	: 69 %
Memo	:	Atmospheric Pressure	: 995 hpa

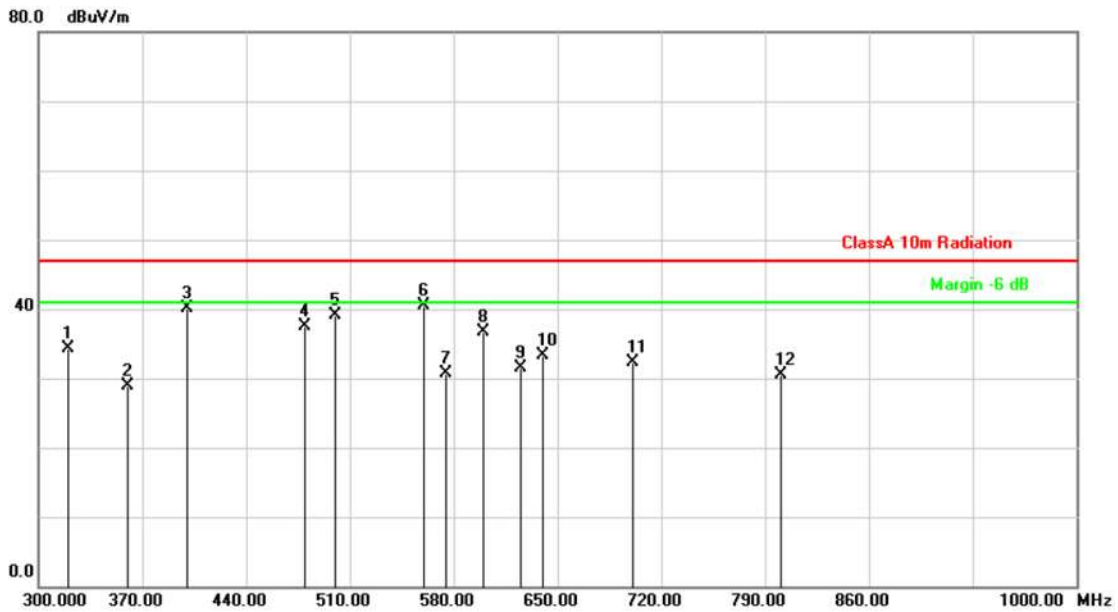

No.	Frequency (MHz)	Factor (dB/m)	Reading (dBuV)	Level (dBuV/m)	Limit (dBuV/m)	Margin (dB)	Detector	Height (cm)	Azimuth (°)	P/F
1	320.3000	-9.45	43.68	34.23	47.00	-12.77	QP	100	0	P
2	360.2000	-8.44	37.31	28.87	47.00	-18.13	QP	100	0	P
3	400.1000	-7.18	47.30	40.12	47.00	-6.88	QP	100	0	P
4	479.9000	-5.35	42.81	37.46	47.00	-9.54	QP	100	0	P
5	500.2000	-4.96	44.15	39.19	47.00	-7.81	QP	100	0	P
6	560.0000	-3.26	43.68	40.42	47.00	-6.58	QP	246	277	P
7	575.1000	-3.29	34.03	30.74	47.00	-16.26	QP	100	0	P
8	599.6000	-3.36	40.09	36.73	47.00	-10.27	QP	100	0	P
9	624.8000	-3.01	34.58	31.57	47.00	-15.43	QP	100	0	P
10	640.2000	-2.78	36.18	33.40	47.00	-13.60	QP	100	0	P
11	700.4000	-2.39	34.63	32.24	47.00	-14.76	QP	100	0	P
12	800.5000	-0.56	31.12	30.56	47.00	-16.44	QP	100	0	P

Note: Level = Reading + Factor  
Margin = Level - Limit

Test engineer: Charlie



4.6. Test Result and Data (1GHz ~ 18GHz)

Power	: PoE	Pol/Phase	: VERTICAL
Test Mode 1	: Live View + Link LAN: 100Mbps	Temperature	: 26 °C
Test Date	: Oct. 04, 2013	Humidity	: 48 %
Memo	:	Atmospheric Pressure	: 1014 hpa

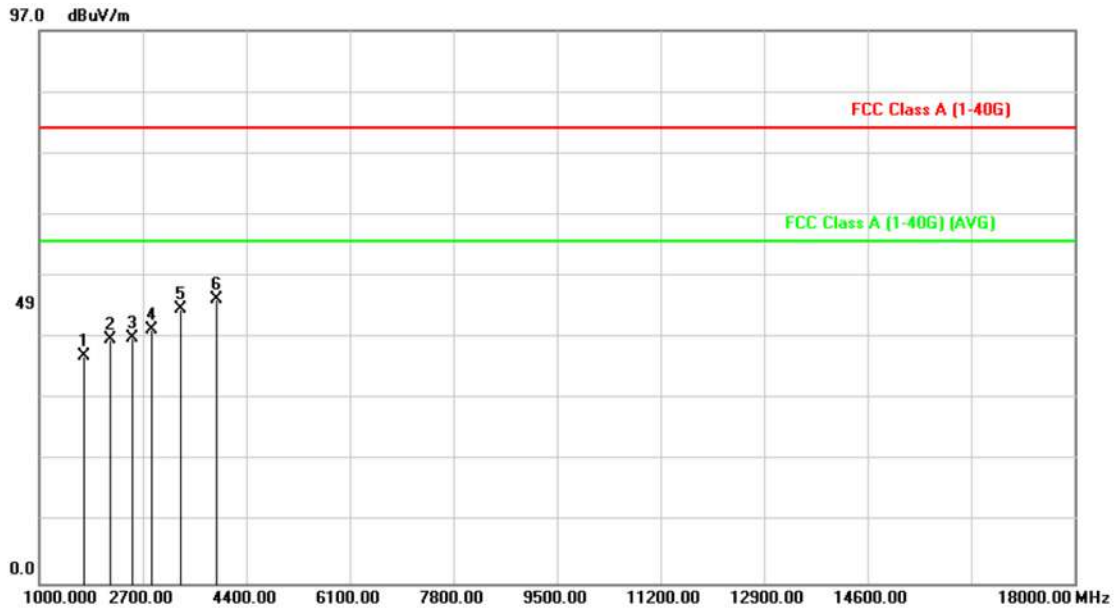

No.	Frequency (MHz)	Factor (dB/m)	Reading (dBuV)	Level (dBuV/m)	Limit (dBuV/m)	Margin (dB)	Detector	Height (cm)	Azimuth (°)	P/F
1	1731.000	-4.54	44.33	39.79	80.00	-40.21	peak	400	0	P
2	2173.000	-2.19	45.07	42.88	80.00	-37.12	peak	400	0	P
3	2530.000	-0.86	43.88	43.02	80.00	-36.98	peak	400	0	P
4	2836.000	0.71	43.82	44.53	80.00	-35.47	peak	400	0	P
5	3312.000	2.65	45.51	48.16	80.00	-31.84	peak	400	0	P
6	3907.000	5.06	44.70	49.76	80.00	-30.24	peak	400	0	P

Note: Level = Reading + Factor  
Margin = Level – Limit





Power	: PoE	Pol/Phase	: HORIZONTAL
Test Mode 1	: Live View + Link LAN: 100Mbps	Temperature	: 26 °C
Test Date	: Oct. 04, 2013	Humidity	: 48 %
Memo	:	Atmospheric Pressure	: 1014 hpa

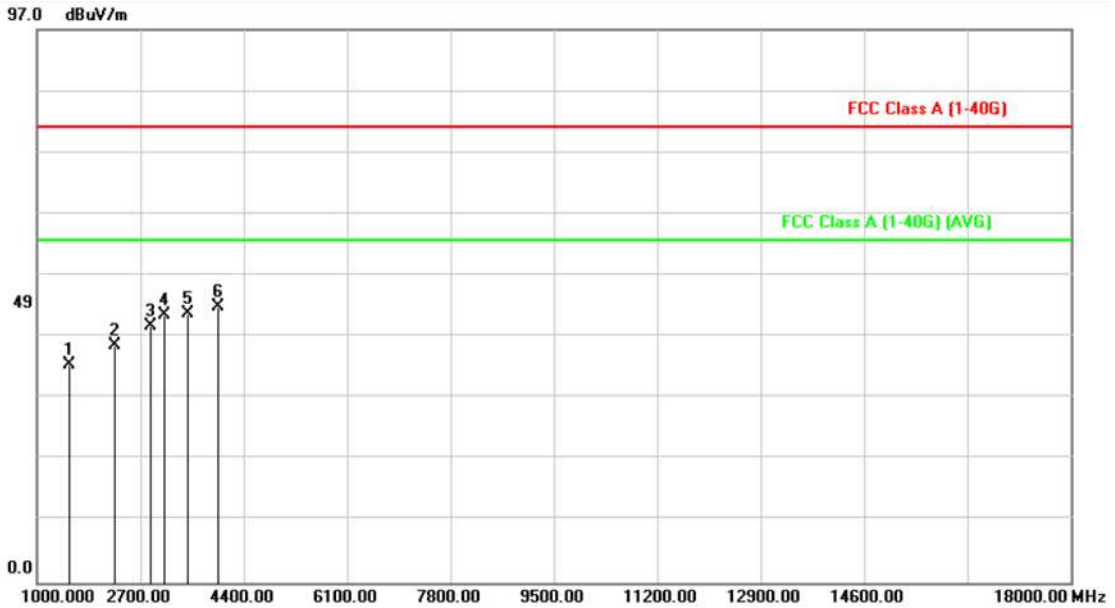

No.	Frequency (MHz)	Factor (dB/m)	Reading (dBuV)	Level (dBuV/m)	Limit (dBuV/m)	Margin (dB)	Detector	Height (cm)	Azimuth (°)	P/F
1	1527.000	-5.85	44.14	38.29	80.00	-41.71	peak	100	0	P
2	2275.000	-1.83	43.33	41.50	80.00	-38.50	peak	100	0	P
3	2870.000	0.89	44.01	44.90	80.00	-35.10	peak	100	0	P
4	3091.000	1.87	44.98	46.85	80.00	-33.15	peak	100	0	P
5	3482.000	3.25	43.95	47.20	80.00	-32.80	peak	100	0	P
6	3975.000	5.34	42.99	48.33	80.00	-31.67	peak	100	0	P

Note: Level = Reading + Factor  
Margin = Level – Limit

Test engineer: Smith



#### 4.7. Test Photographs (30MHz~1GHz)

Front View



Rear View





#### 4.1. Test Photographs (1GHz~18GHz)

Front View

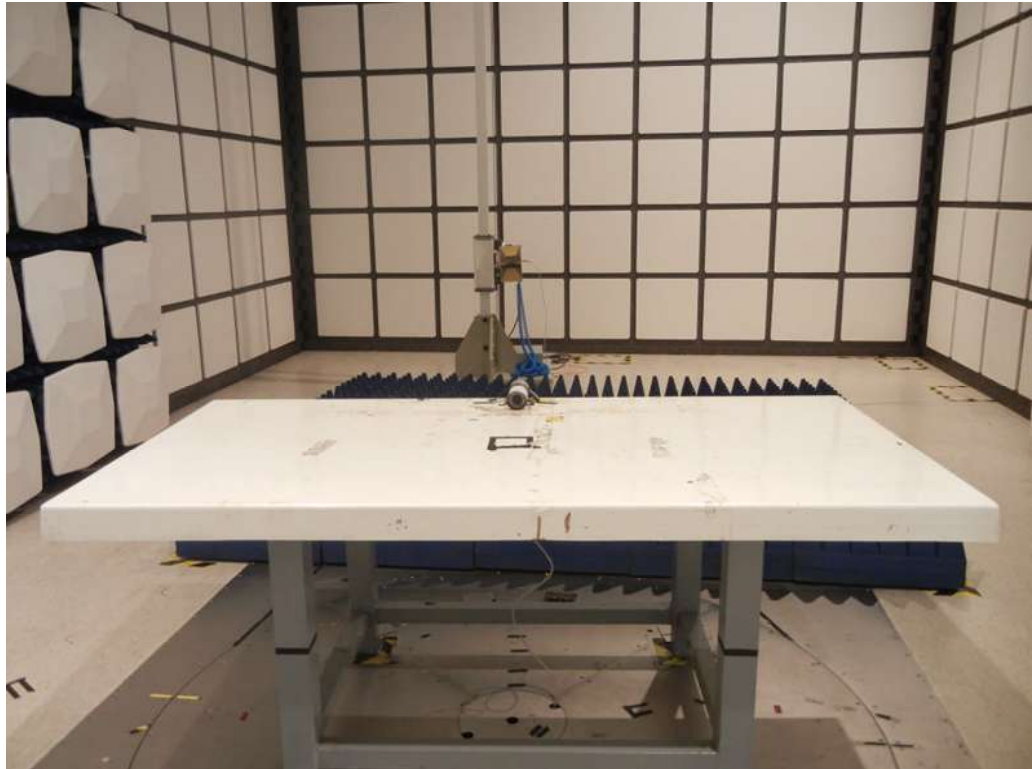

Rear View

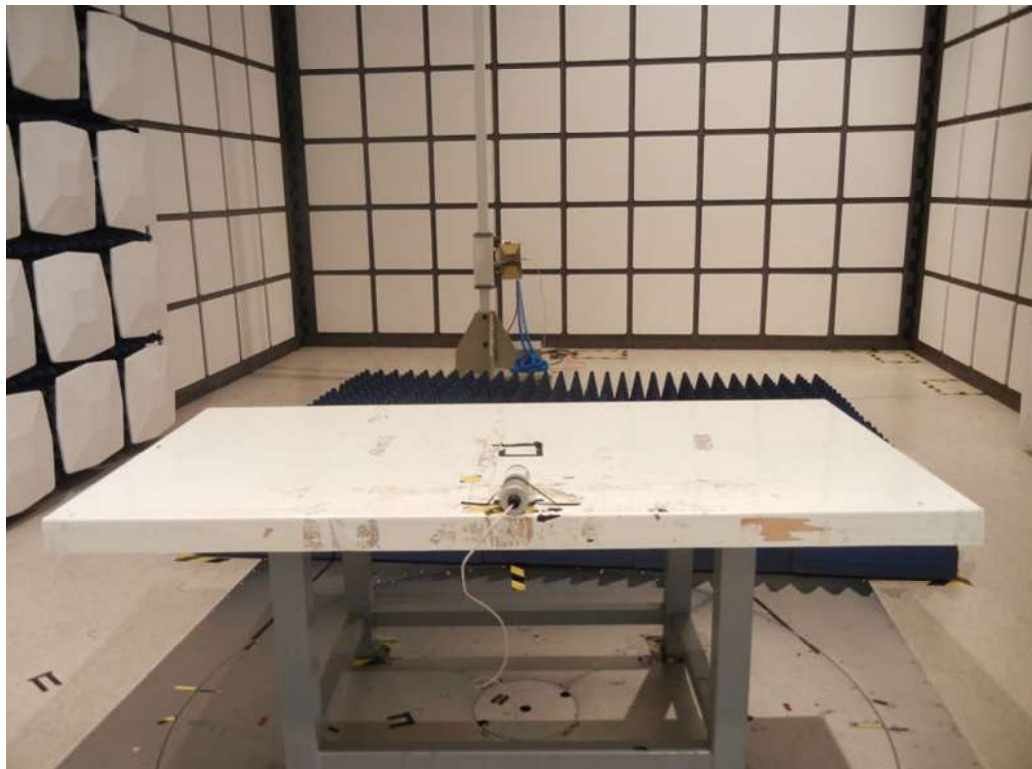



Appendix A. Photographs of EUT



