

DrayTek

Vigor2760 Series

High Speed VDSL2 Router



Quick Start Guide

V1.03

Vigor2760 Series High Speed VDSL2 Router Quick Start Guide

Version: 1.03

Firmware Version: V3.7.5.1

(For future update, please visit DrayTek web site)

Date: August 15, 2014

Copyright Information

Copyright Declarations

© 2014 All rights reserved. This publication contains information that is protected by copyright. No part may be reproduced, transmitted, transcribed, stored in a retrieval system, or translated into any language without written permission from the copyright holders.

Trademarks

The following trademarks are used in this document:

- Microsoft is a registered trademark of Microsoft Corp.
- Windows, Windows 95, 98, Me, NT, 2000, XP, Vista and Explorer are trademarks of Microsoft Corp.
- Apple and Mac OS are registered trademarks of Apple Inc.
- Other products may be trademarks or registered trademarks of their respective manufacturers.

Safety Instructions and Approval

Safety Instructions

- Read the installation guide thoroughly before you set up the router.
- The router is a complicated electronic unit that may be repaired only by authorized and qualified personnel. Do not try to open or repair the router yourself.
- Do not place the router in a damp or humid place, e.g. a bathroom.
- Do not stack the routers.
- The router should be used in a sheltered area, within a temperature range of +5 to +40 Celsius.
- Do not expose the router to direct sunlight or other heat sources. The housing and electronic components may be damaged by direct sunlight or heat sources.
- Do not deploy the cable for LAN connection outdoor to prevent electronic shock hazards.
- Keep the package out of reach of children.
- When you want to dispose of the router, please follow local regulations on conservation of the environment.

Warranty

We warrant to the original end user (purchaser) that the router will be free from any defects in workmanship or materials for a period of two (2) years from the date of purchase from the dealer. Please keep your purchase receipt in a safe place as it serves as proof of date of purchase. During the warranty period, and upon proof of purchase, should the product have indications of failure due to faulty workmanship and/or materials, we will, at our discretion, repair or replace the defective products or components, without charge for either parts or labor, to whatever extent we deem necessary to restore the product to proper operating condition. Any replacement will consist of a new or re-manufactured functionally equivalent product of equal value, and will be offered solely at our discretion. This warranty will not apply if the product is modified, misused, tampered with, damaged by an act of God, or subjected to abnormal working conditions. The warranty does not cover the bundled or licensed software of other vendors. Defects which do not significantly affect the usability of the product will not be covered by the warranty. We reserve the right to revise the manual and online documentation and to make changes from time to time in the contents hereof without obligation to notify any person of such revision or changes.

Be a Registered Owner

Web registration is preferred. You can register your Vigor router via <http://www.draytek.com>.

Firmware & Tools Updates

Due to the continuous evolution of DrayTek technology, all routers will be regularly upgraded. Please consult the DrayTek web site for more information on newest firmware, tools and documents.

<http://www.draytek.com>

European Community Declarations

Manufacturer: DrayTek Corp.
Address: No. 26, Fu Shing Road, HuKou Township, HsinChu Industrial Park, Hsin-Chu, Taiwan 303
Product: Vigor2760 Series Router

DrayTek Corp. declares that Vigor2760 Series of routers are in compliance with the following essential requirements and other relevant provisions of R&TTE Directive 1999/5/EEC.

The product conforms to the requirements of Electro-Magnetic Compatibility (EMC) Directive 2004/108/EC by complying with the requirements set forth in EN55022/Class B and EN55024/Class B.

The product conforms to the requirements of Low Voltage (LVD) Directive 2006/95/EC by complying with the requirements set forth in EN60950-1.

This product is designed for POTS, DSL, 2.4GHz WLAN network throughout the EC region and Switzerland with restrictions in France. Please see the user manual for the applicable networks on your product.

Regulatory Information

Federal Communication Commission Interference Statement

This equipment has been tested and found to comply with the limits for a Class B digital device, pursuant to Part 15 of the FCC Rules. These limits are designed to provide reasonable protection against harmful interference in a residential installation. This equipment generates, uses and can radiate radio frequency energy and, if not installed and used in accordance with the instructions, may cause harmful interference to radio communications. However, there is no guarantee that interference will not occur in a particular installation. If this equipment does cause harmful interference to radio or television reception, which can be determined by turning the equipment off and on, the user is encouraged to try to correct the interference by one of the following measures:

- Reorient or relocate the receiving antenna.
- Increase the separation between the equipment and receiver.
- Connect the equipment into an outlet on a circuit different from that to which the receiver is connected.
- Consult the dealer or an experienced radio/TV technician for help.

This device complies with Part 15 of the FCC Rules. Operation is subject to the following two conditions:

- (1) This device may not cause harmful interference, and
- (2) This device may accept any interference received, including interference that may cause undesired operation.

RF Exposure Warning

This equipment must be installed and operated in accordance with provided instructions and the antenna(s) used for this transmitter must be installed to provide a separation distance of at least 20 cm from all persons and must not be co-located or operating in conjunction with any other antenna or transmitter. End-users and installers must be provided with antenna installation instructions and transmitter operating conditions for satisfying RF exposure compliance.

Caution

Any changes or modifications not expressly approved by the grantee of this device could void the user's authority to operate the equipment.

The antenna/transmitter should be kept at least 20 cm away from human body.

DrayTek Vigor2760 series VDSL2/ADSL2+ routers are compliant with 47 C.F.R. Part 68.



More update, please visit www.draytek.com.

Table of Contents

1. Introduction	1
1.1 Panel Explanation.....	2
1.1.1 For Vigor2760	2
1.1.2 For Vigor2760n	4
1.1.3 For Vigor2760Vn.....	6
1.2 Package Content	8
2. Installing Your Router	9
2.1 Hardware Installation	9
2.2 Printer Installation	11
3. Quick Setup	19
3.1 Accessing Web User Interface.....	19
3.2 Basic Configuration – Quick Start Wizard	20
3.2.1 For WAN1 (ADSL/VDSL2)	22
3.2.2 For WAN2 (Ethernet)	26
3.2.3 For WAN3 (USB)	34
3.3 Wireless Configuration.....	36
3.3.1 Basic Wireless LAN Concept	36
3.3.2 Wireless Wizard	37
4. Trouble Shooting.....	39
4.1 Checking If the Hardware Status Is OK or Not.....	39
4.2 Checking If the Network Connection Settings on Your Computer Is OK or Not	40
4.3 Pinging the Router from Your Computer	43
4.4 Checking If the ISP Settings are OK or Not	44
4.5 Problems for 3G Network Connection	44
4.6 Backing to Factory Default Setting If Necessary.....	45
4.7 Contacting DrayTek	46

1. Introduction

The Vigor2760 series are the routers with high speed in data transmission through DSL port and LAN ports.

With the development of NGN (Next Generation Network), you may recently hear the news about FTTx deployment in your local area or even have already subscribed the unbundling last mile service (e.g. VDSL2) from local ITSP for FTTx. As adopting FTTx, the main question for end users is whether your legacy router could fully utilize its bandwidth or not.

DrayTek launches Vigor2760 series – High speed router, perfectly complied with VDSL2 environment including Vigor2760, Vigor2760n and Vigor2760Vn for speed-wanted customers. With high throughput performance and secured broadband connectivity provided by Vigor2760 series, you can simultaneously engage these bandwidth-intensive applications, such as high-definition video streaming, online gaming, and Internet telephony / access.



Vigor2760 supports up to 2 VPN tunnels using advanced protocols such as IPSec/PPTP (for remote dial-in only) with AES/3DES for encryption and MD5/SHA-1 for authentication.

Vigor2760 ‘n’ models comply with 802.11n standards. They support WEP/WPA/WPA2 encryption and MAC Address Control.





Vigor2760 ‘V’ models provide two analogue phone connectors. It supports multiple SIP registrars with high flexible configuration and call handing options.

In addition, Vigor2760 series supports two USB interfaces for connecting USB printer to share the printer or USB storage device for sharing files and 3G/4G backup services.

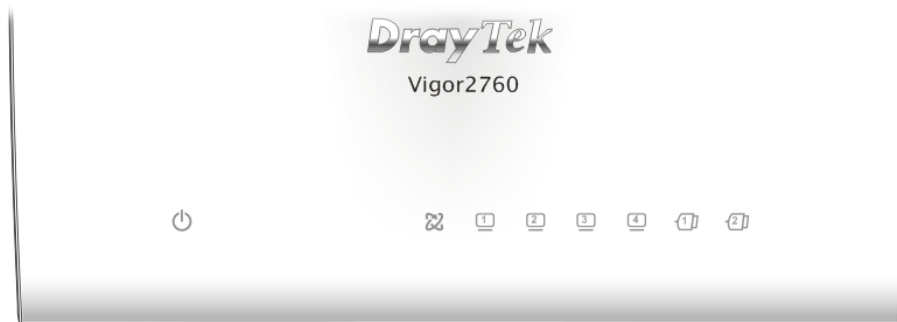
1.1 Panel Explanation

1.1.1 For Vigor2760





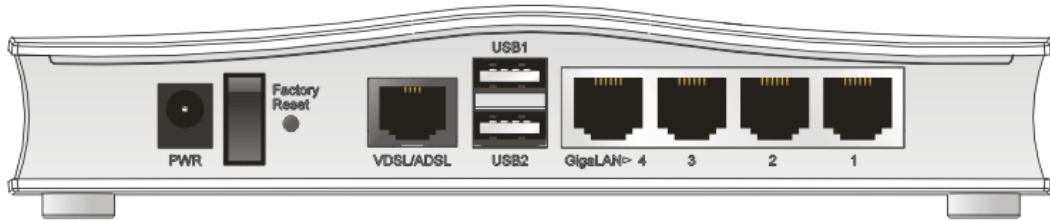



LED	Status	Explanation
 (ACT)	Blinking	The router is powered on and running normally.
	Off	The router is powered off.
 DSL (Green)	On	The DSL port is connected.
	Blinking (Slowly)	The router is ready.
	Blinking (Quickly)	The connection is training.
 LAN1/2/3/4 (Green)	On	The port is connected.
	Blinking (Green)	The data is transmitting.
 USB1/2	On	A USB device is connected and active.

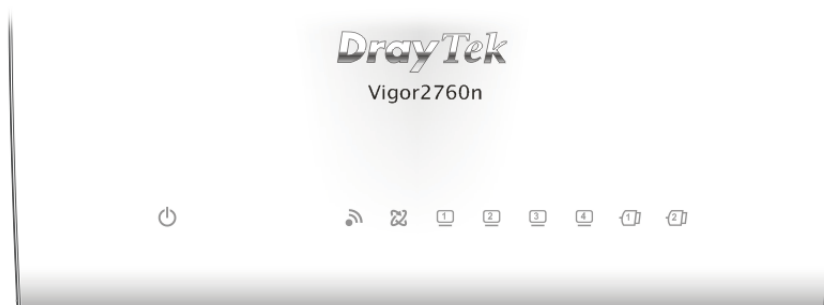

Interface	Description
PWR	Connector for a power adapter.
I / O	Power switch.
Factory Reset	Restore the default settings. Usage: Turn on the router (ACT LED is blinking). Press the hole and keep for more than 5 seconds. When you see the ACT LED begins to blink rapidly than usual, release the button. Then the router will restart with the factory default configuration.
VDSL/ADSL	Connector for accessing the Internet.
USB (1-2)	Connector for USB storage device or printer or 3G backup.
LAN (1-4)	Connectors for local network devices.

1.1.2 For Vigor2760n





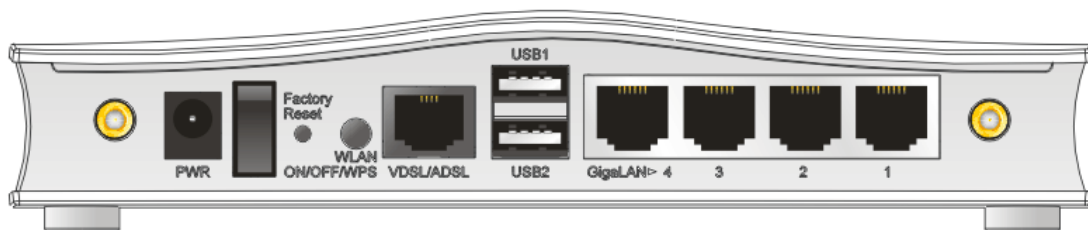



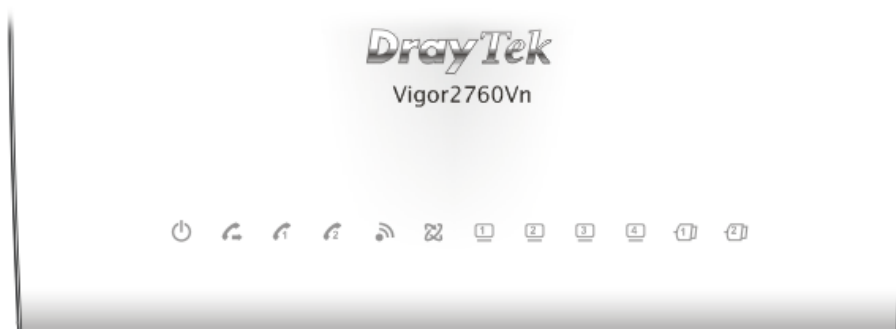

LED	Status	Explanation
 (ACT)	Blinking	The router is powered on and running normally.
	Off	The router is powered off.
 (Wireless LAN On/Off/WPS)	On (Green)	The wireless access point is ready.
	Blinking (Green)	The data is transmitting via wireless connection.
	Blinking (Orange)	Blinks with one second cycle for two minutes. The WPS function is active.
	Off	The wireless access point is turned off.
 DSL (Green)	On	The DSL port is connected.
	Blinking (Slowly)	The router is ready.
	Blinking (Quickly)	The router is trying to connect to Internet.
 LAN1/2/3/4	On	The port is connected.
	Blinking	The data is transmitting.
 USB1/2	On	A USB device is connected and active.



Interface	Description
PWR	Connector for a power adapter.
I / O	Power switch.
Factory Reset	Restore the default settings. Usage: Turn on the router (ACT LED is blinking). Press the hole and keep for more than 5 seconds. When you see the ACT LED begins to blink rapidly than usual, release the button. Then the router will restart with the factory default configuration.
WLAN ON/OFF/WPS	WLAN WPS - Press this button for 2 seconds to wait for client device making network connection through WPS. When the LED lights up, the WPS connection will be on. WLAN ON/OFF - Press the button once to enable (WLAN LED on) or disable (WLAN LED off) wireless connection.
VDSL/ADSL	Connector for accessing the Internet.
USB (1-2)	Connector for USB storage device or printer or 3G/4G backup.
LAN (1-4)	Connectors for local network devices.

1.1.3 For Vigor2760Vn



LED	Status	Explanation
 (ACT)	Blinking	The router is powered on and running normally.
	Off	The router is powered off.
 (LINE)	On	A PSTN phone call comes (in and out). However, when the phone call is disconnected, the LED will be off for awhile.
	Off	There is no PSTN phone call.
 (Phone1/Phone2)	On	The phone connected to this port is off-hook.
	Off	The phone connected to this port is on-hook.
	Blinking	A phone call comes.
 (Wireless LAN On/Off/WPS)	On (Green)	The wireless access point is ready.
	Blinking (Green)	The data is transmitting via wireless connection.
	Blinking (Orange)	Blinks with one second cycle for two minutes. The WPS function is active.
	Off	The wireless access point is turned off.
 DSL (Green)	On	The DSL port is connected.
	Blinking (Slowly)	The router is ready.
	Blinking (Quickly)	The router is trying to connect to Internet.
 LAN1/2/3/4	On	The port is connected.
	Blinking	The data is transmitting.
 USB1/2	On	A USB device is connected and active.

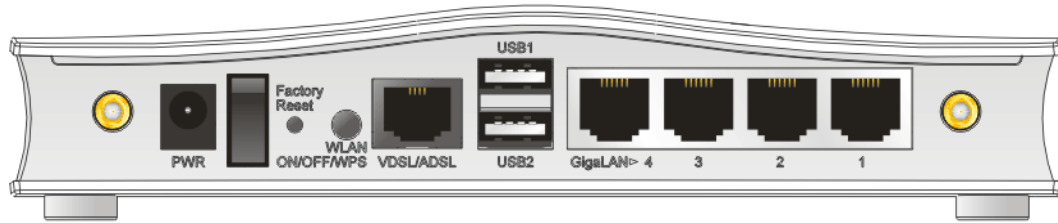

Interface	Description
PWR	Connector for a power adapter.
I / O	Power switch.
Factory Reset	Restore the default settings. Usage: Turn on the router (ACT LED is blinking). Press the hole and keep for more than 5 seconds. When you see the ACT LED begins to blink rapidly than usual, release the button. Then the router will restart with the factory default configuration.
WLAN ON/OFF/WPS	WLAN WPS - Press this button for 2 seconds to wait for client device making network connection through WPS. When the LED lights up, the WPS connection will be on. WLAN ON/OFF - Press the button once to enable (WLAN LED on) or disable (WLAN LED off) wireless connection.
VDSL/ADSL	Connector for accessing the Internet.
USB (1-2)	Connector for USB storage device or printer or 3G/4G backup.
LAN (1-4)	Connectors for local network devices.

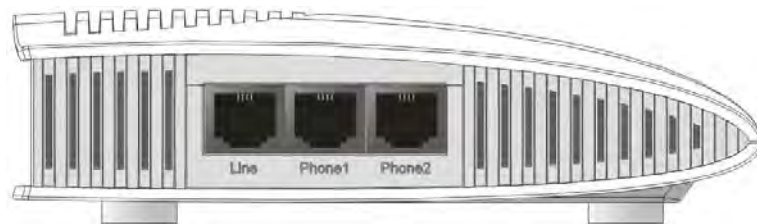

Interface	Description
Line	Connector for PSTN life line.
Phone1/Phone2	Connector of analog phone for VoIP communication.

1.2 Package Content

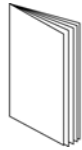

① Quick Start Guide

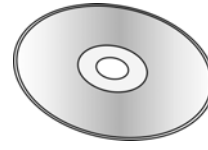

② CD

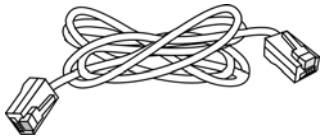

③ RJ-45 Cable (Ethernet)

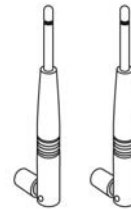

④ Antenna (n models)

⑤ The type of the power adapter depends on the country that the router will be installed. * The maximum power consumption is **17-23 Watt**.

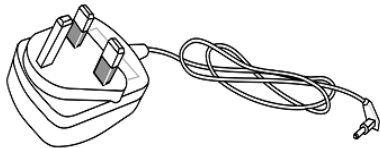

UK-type Power Adapter

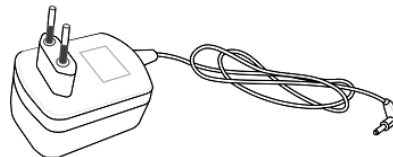

EU-type Power Adapter

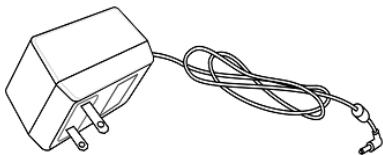

USA/Taiwan-type Power Adapter



AU/NZ-type Power Adapter

Firmware Updates

Firmware updates for your product ensure that you have the latest set of features, security updates and improvements for your product.

Please note that if your Vigor 2760 product has firmware version 1.x.x or earlier then it can only update to later 1.x.x firmware. If your Vigor 2760 has firmware version 3.7.5 or later ('Delight/DrayOS' hardware) then you can upgrade to any compatible later firmware. You cannot use Delight/DrayOS firmware on original (classic) Vigor 2760 hardware or vice-versa. This manual applies only to DrayOS/Delight hardware/firmware.

2. Installing Your Router

This section will guide you to install the router through hardware connection and configure the router's settings through web browser.

2.1 Hardware Installation

Before starting to configure the router, you have to connect your devices correctly. (For the hardware connection, we take “Vn” model as an example.)

1. Connect the XDSL interface to the external XDSL splitter with an XDSL line cable for all models. For Vigor2760Vn, also connect Line interface to external XDSL splitter.

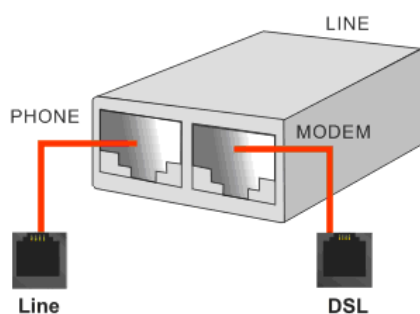

2. Connect one port of 4-port switch to your computer with a RJ-45 cable. This device allows you to connect 4 PCs directly.
3. Connect Phone port to a conventional analog telephone (for V model only).
4. Connect detachable antennas to the router for Vigor2760 series (for n model only).
5. Connect one end of the power cord to the power port of this device. Connect the other end to the wall outlet of electricity.
6. Power on the router.
7. Check the **ACT** and **DSL**, **LAN** LEDs to assure network connection.

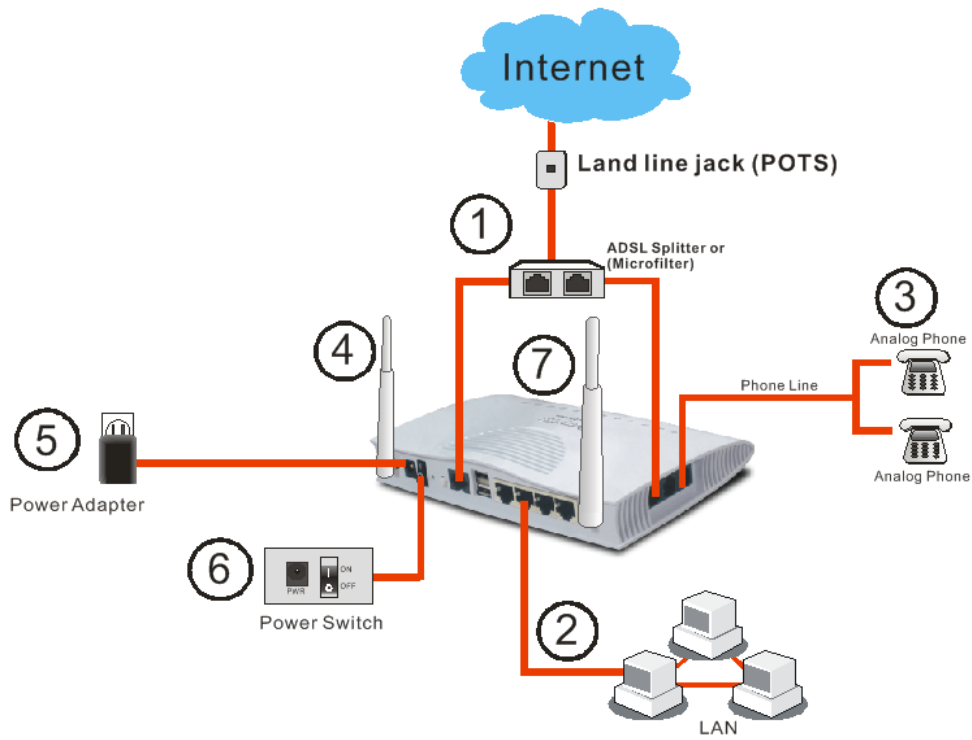

(For the detailed information of LED status, please refer to section 1.1.)

2.2 Printer Installation

You can install a printer onto the router for sharing printing. All the PCs connected this router can print documents via the router. The example provided here is made based on Windows XP/2000. For Windows 98/SE/Vista, please visit www.draytek.com.

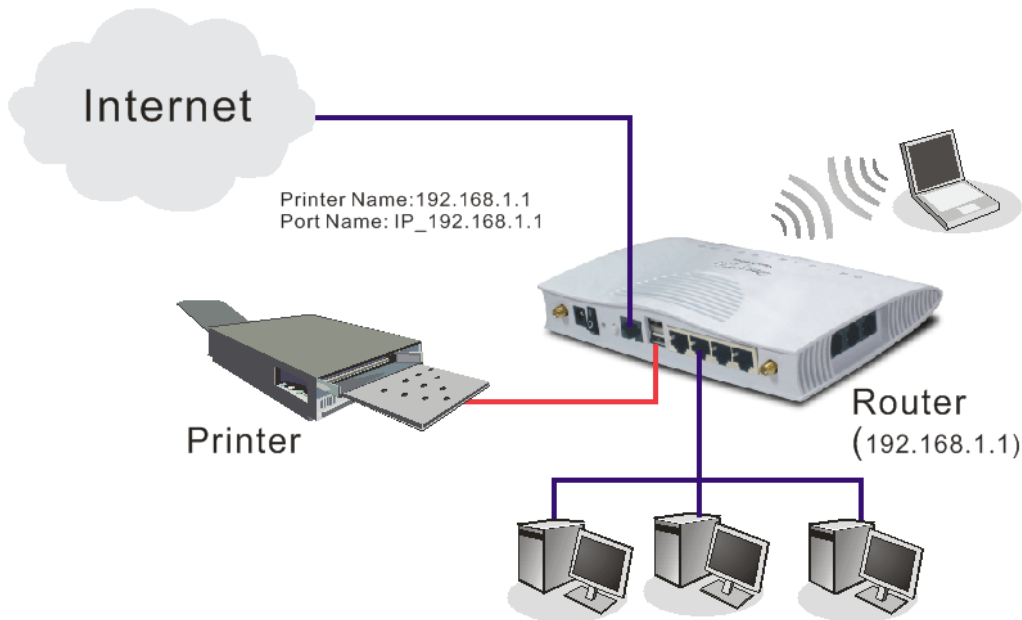

Before using it, please follow the steps below to configure settings for connected computers (or wireless clients).

1. Connect the printer with the router through USB/parallel port.
2. Open **All Programs>>Getting Started>>Devices and Printers**.

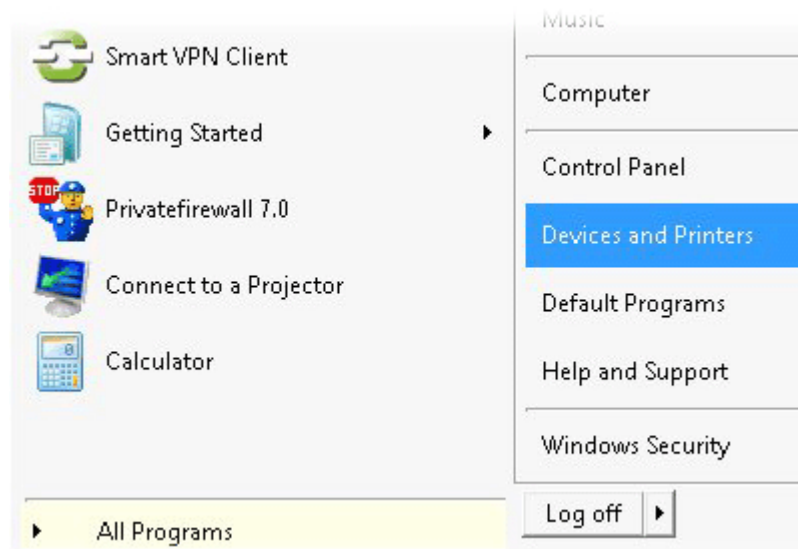

3. Click **Add a printer**.

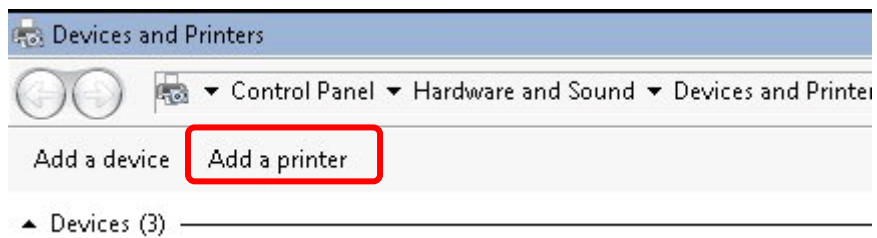

4. A dialog will appear. Click **Add a local printer** and click **Next**.

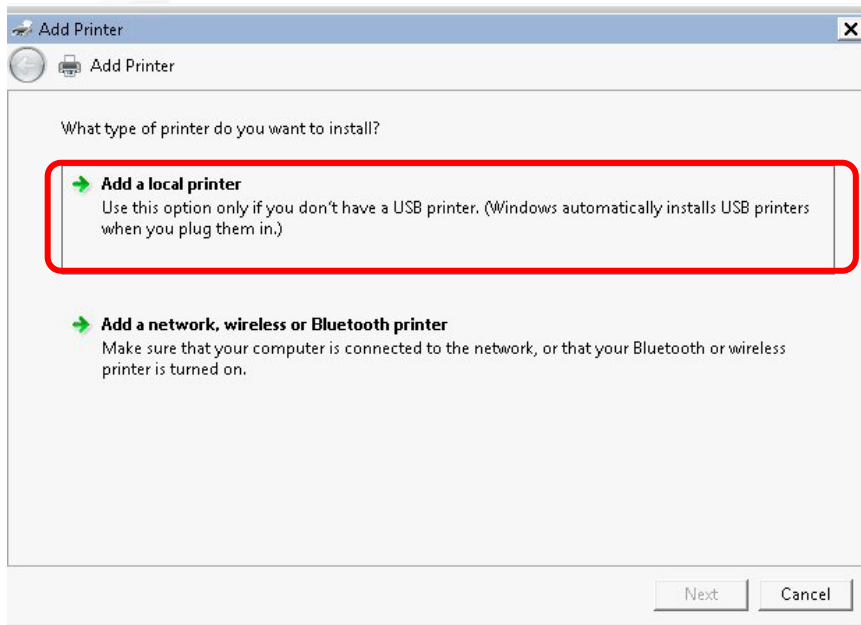

5. In this dialog, choose **Create a new port**. In the field of **Type of port**, use the drop down list to select **Standard TCP/IP Port**. Then, click **Next**.

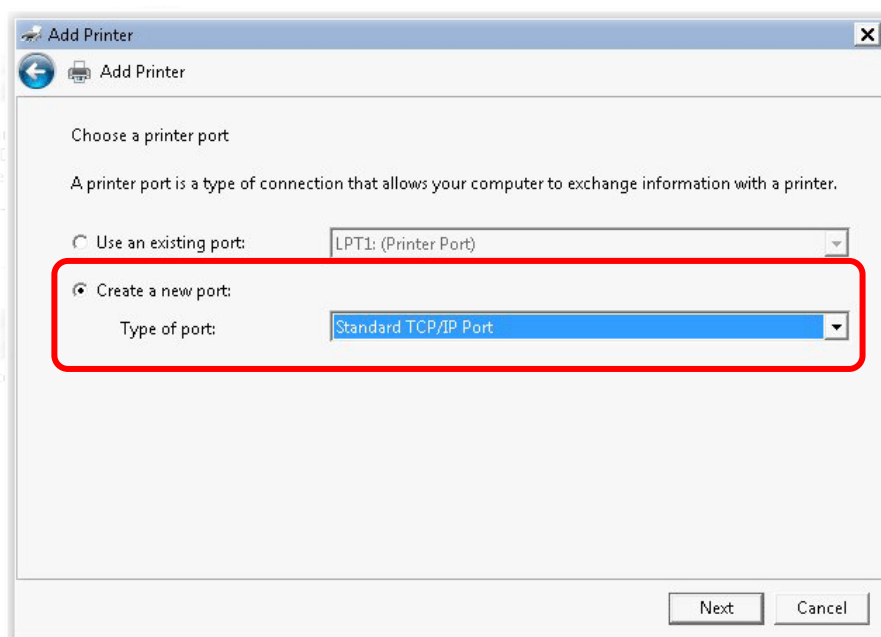

6. In the following dialog, type **192.168.1.1** (router's LAN IP) in the field of **Hostname or IP Address** and type **192.168.1.1** as the **Port name**. Then, click **Next**.

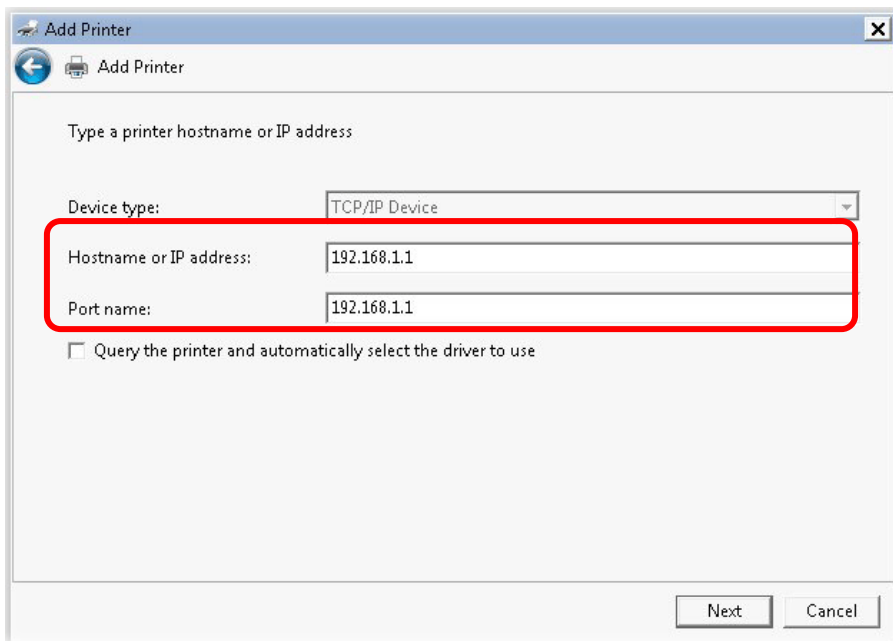

7. Click **Standard** and choose **Generic Network Card**.

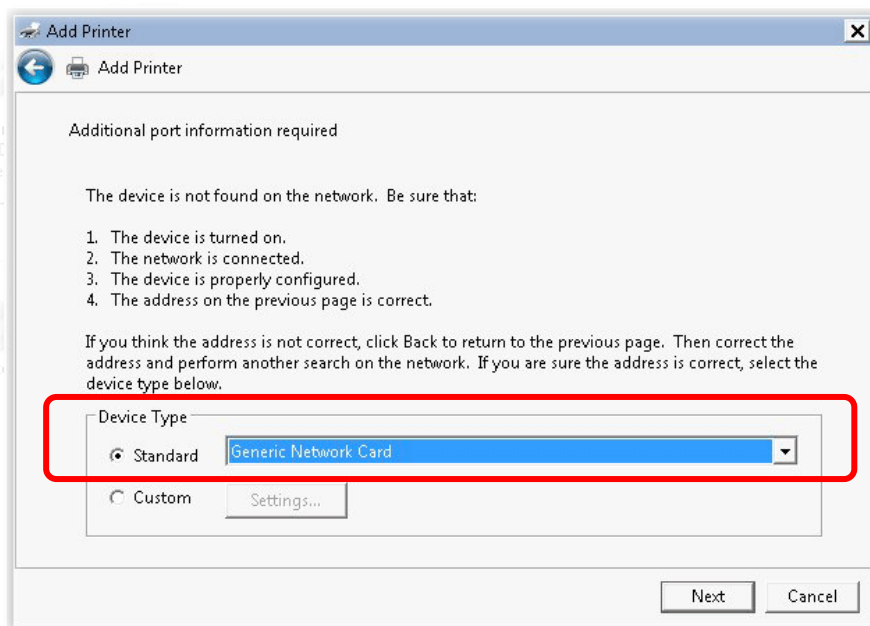

- Now, your system will ask you to choose right name of the printer that you installed onto the router. Such step can make correct driver loaded onto your PC. When you finish the selection, click **Next**.

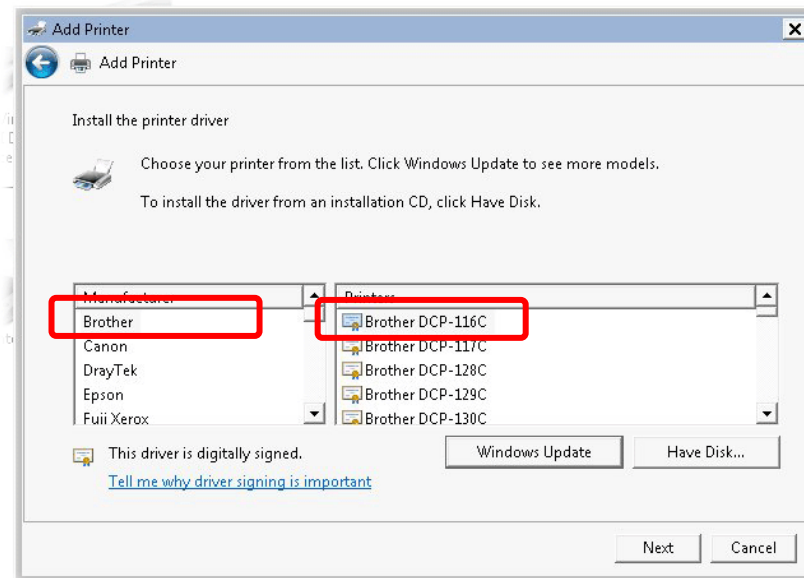

- Type a name for the chosen printer. Click **Next**.

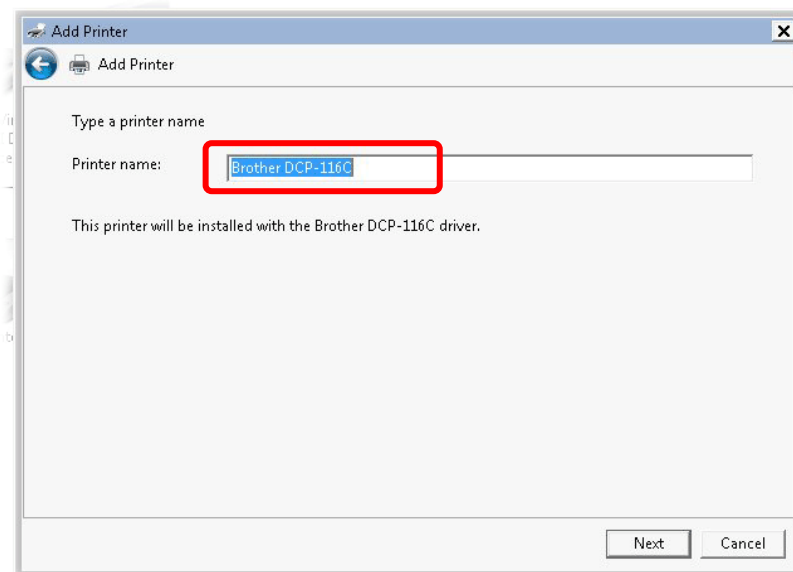

10. Choose **Do not share this printer** and click **Next**.

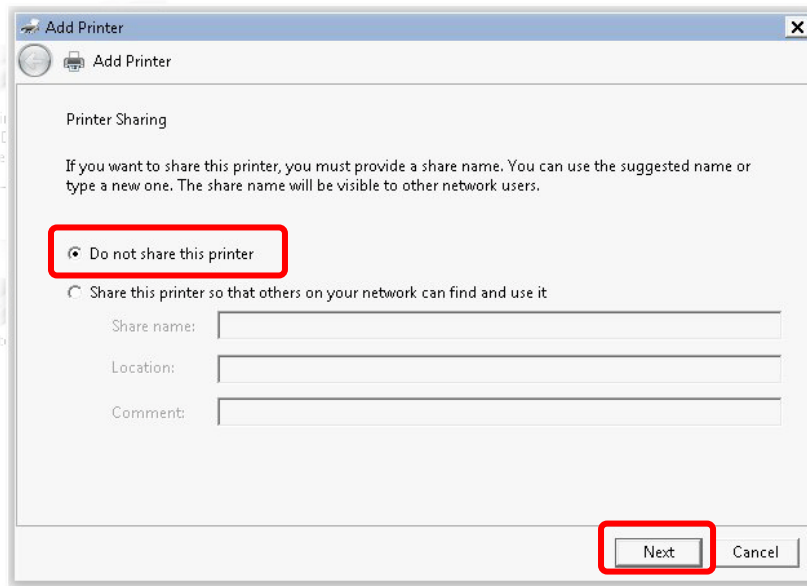

11. Then, in the following dialog, click **Finish**.

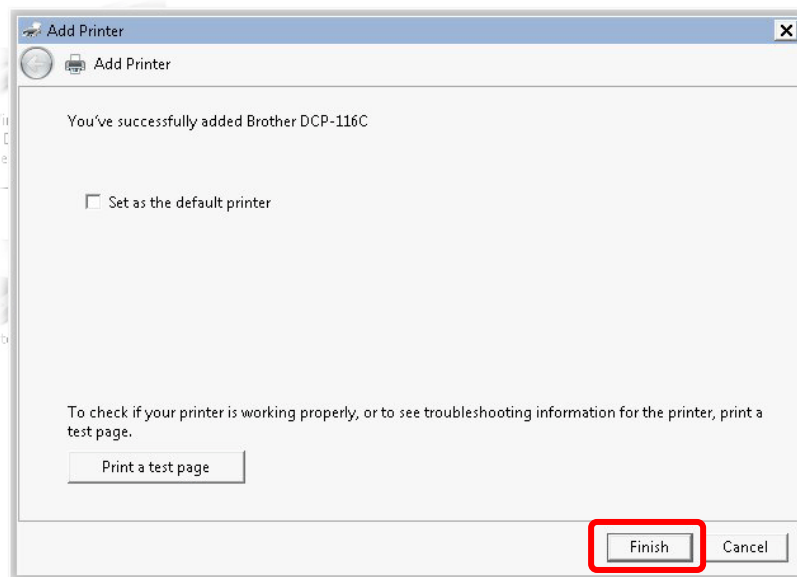

12. The new printer has been added and displayed under **Printers and Faxes**. Click the new printer icon and click **Printer server properties**.

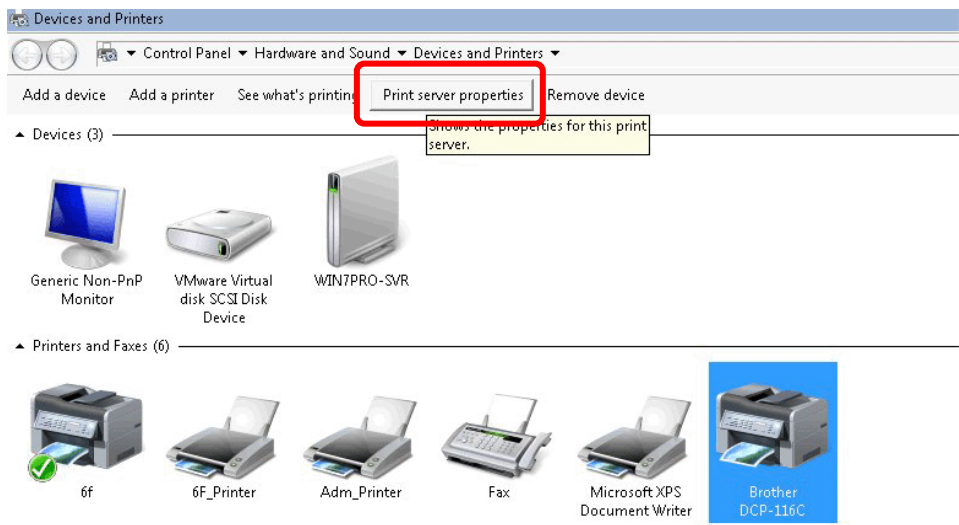

13. Edit the property of the new printer you have added by clicking **Configure Port**.

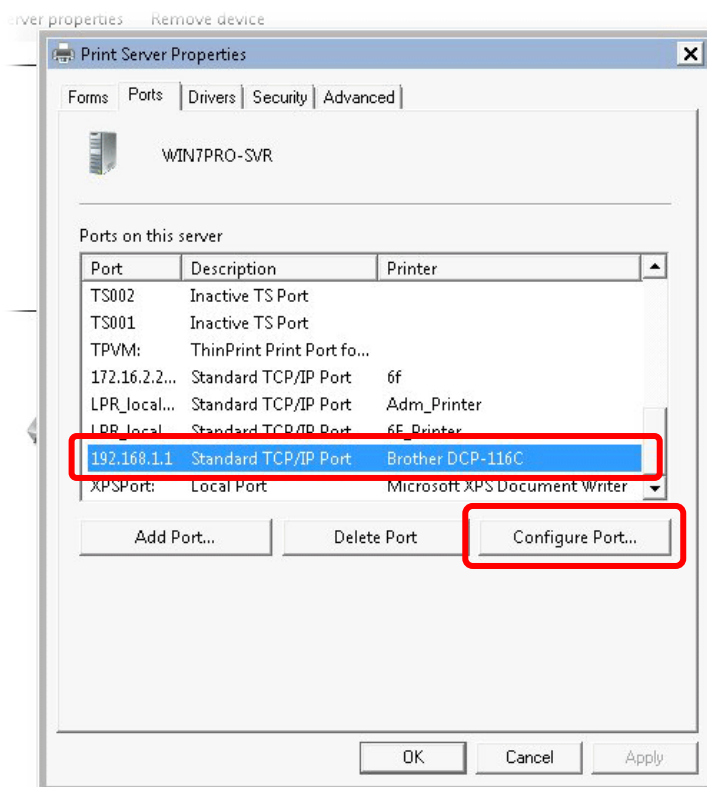

14. Select "LPR" on Protocol, type **p1** (number 1) as **Queue Name**. Then click **OK**. Next please refer to the red rectangle for choosing the correct protocol and LPR name.

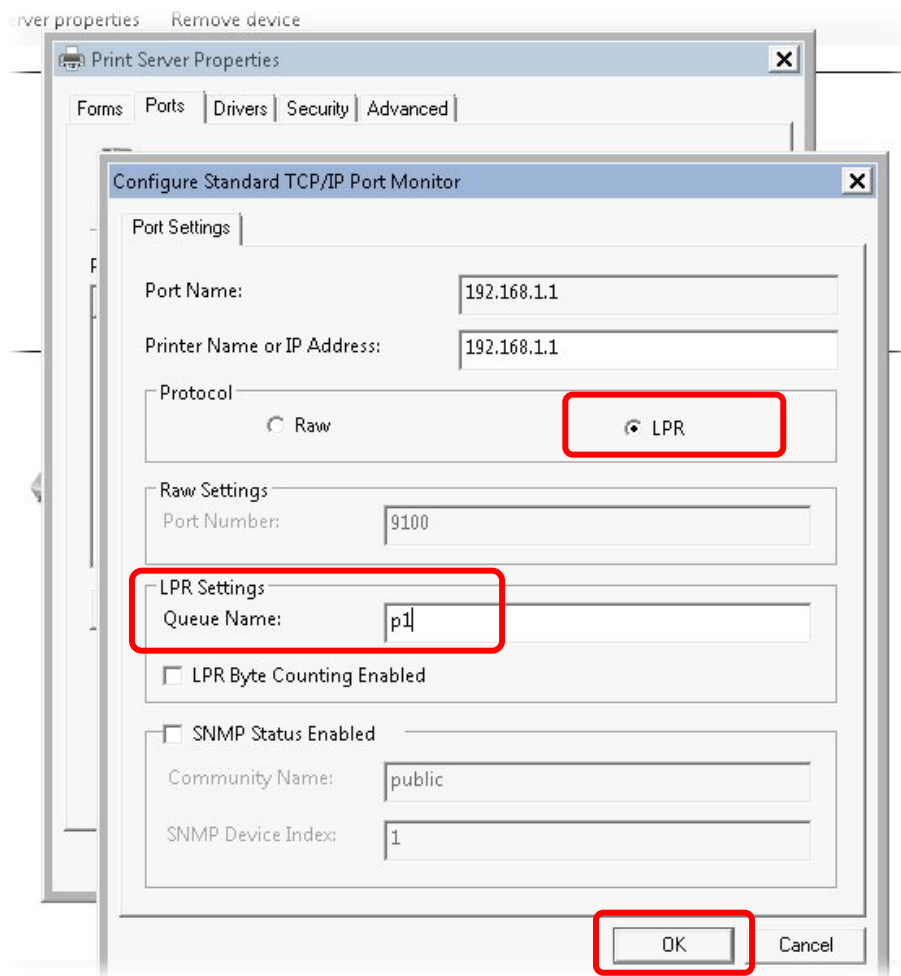

The printer can be used for printing now. Most of the printers with different manufacturers are compatible with vigor router.

Note 1: Some printers with the fax/scanning or other additional functions are not supported. If you do not know whether your printer is supported or not, please visit www.draytek.com to find out the printer list. Open **Support >FAQ/Application Notes**; find out the link of **USB>>Printer Server** and click it.

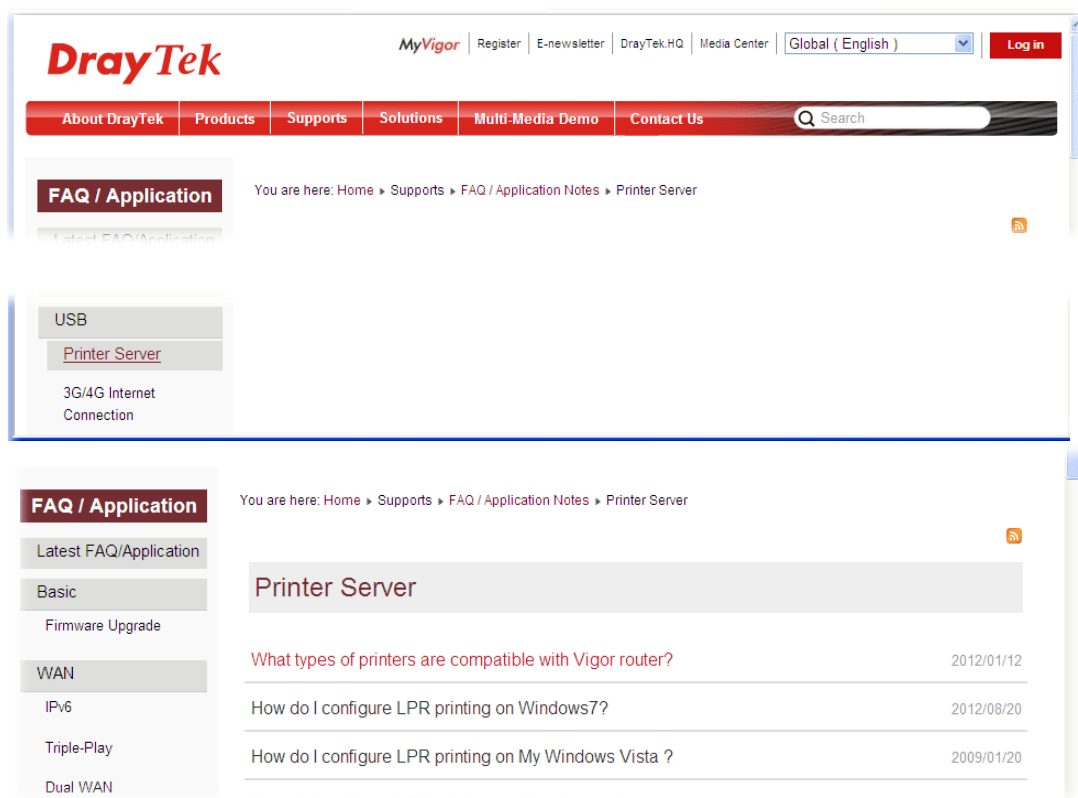

Note 2: Vigor router supports printing request from computers via LAN ports but not DSL port.

3. Quick Setup

To access Internet, please finish basic configuration after completing the hardware installation.

3.1 Accessing Web User Interface

1. Make sure your PC connects to the router correctly.



Notice: You may either simply set up your computer to get IP dynamically from the router or set up the IP address of the computer to be the same subnet as **the default IP address of Vigor router 192.168.1.1**. For the detailed information, please refer to the later section - Trouble Shooting of the guide.

2. Open a web browser on your PC and type **http://192.168.1.1**.
3. The following window will be open to ask for username and password. Please type “admin/admin” on Username/Password and click **Login** for opening the web user interface.

DrayTek **Vigor2760 Series**

Login

Username

Password

Login

Delight

Copyright © 2013 DrayTek Corp. All Rights Reserved.



Notice: If you fail to access to the web configuration, please go to “Trouble Shooting” for detecting and solving your problem.

The home page will change slightly in accordance with the router model you have.

DrayTek Vigor2760 Series Delight

Auto Logout IPv6

Dashboard
Wizards
Online Status

WAN
LAN
Route Policy
NAT
Firewall
Objects Setting
CSM
Bandwidth Management
Applications
VPN and Remote Access
Certificate Management
VoIP
Wireless LAN
USB Application
System Maintenance
Diagnostics

Support Area
Product Registration

All Rights Reserved.

Dashboard

System Information

Model Name	Vigor2760Vn	System Up Time	1:3:22
Router Name		Current Time	2000 Jan 1 Sat 1:3:20
Firmware Version	3.7.5.1	Build Date/Time	Mar 31 2014 10:02:56
DSL Version	05-04-04-04-00-01	LAN MAC Address	00-1D-AA-B8-15-00

Quick Access

- System Status
- Dynamic DNS
- TR-069
- IMP2P Block
- Schedule
- SysLog / Mail Alert
- RADIUS
- Firewall Object Setting
- Data Flow Monitor

IPv4 Internet Access

Line / Mode	IP Address	MAC Address	Up Time
WAN1 ADSL / PPPoA	Disconnected	00-1D-AA-B8-15-01	00:00:00
WAN2 Ethernet / ---	Disconnected	00-1D-AA-B8-15-02	00:00:00
WAN3 USB / ---	Disconnected	00-1D-AA-B8-15-03	00:00:00

IPv6 Internet Access

Mode	Address	Scope	Up Time
LAN RADVD / DHCPv6	FE80::21D:AFF:FEB8:1500/64	Link	

Interface

DSL	Connected : Down Stream : 0Kbps / Up Stream : 0Kbps
WAN	Connected : 0, WAN1 WAN2 WAN3
LAN	Connected : 0, LAN1 LAN2 LAN3 LAN4

3.2 Basic Configuration – Quick Start Wizard

The **Quick Start Wizard** is designed for you to easily set up your router for Internet access.

Dashboard
Wizards
Quick Start Wizard
Service Activation Wizard
VPN Client Wizard
VPN Server Wizard
Wireless Wizard
VoIP Wizard

Open **Wizards>>Quick Start Wizard** to get the following page.

Quick Start Wizard

Enter login password

Please enter an alpha-numeric string as your **Password** (Max 23 characters).

Old Password	<input type="password" value="•••••"/>
New Password	<input type="password" value="•••••"/>
Confirm Password	<input type="password" value="•••••"/>

On the next page as shown below, please select the WAN interface that you use. If DSL interface is used, please choose WAN1; if Ethernet interface is used, please choose WAN2; if 3G/4G USB modem is used, please choose WAN3. Then click **Next** for next step.

Quick Start Wizard

WAN Interface

WAN Interface:	<input type="text" value="WAN1"/>
Display Name:	<input type="text"/>
Physical Mode:	ADSL / VDSL2
Physical Type:	<input type="text" value="Auto negotiation"/>
VLAN Tag insertion	<input type="text" value="Disable"/>

WAN1, WAN2 and WAN3 will bring up different configuration page. Refer to the following for detailed information.

3.2.1 For WAN1 (ADSL/VDSL2)

WAN1 is specified for ADSL or VDSL2 connection.

Quick Start Wizard

WAN Interface

WAN Interface:	<input type="text" value="WAN1"/>
Display Name:	<input type="text"/>
Physical Mode:	ADSL / VDSL2
Physical Type:	<input type="text" value="Auto negotiation"/>
VLAN Tag insertion	<input type="text" value="Enable"/>
Tag value	<input type="text" value="0"/> (0~4095)
Priority	<input type="text" value="0"/> (0~7)

Click **Next** to go to the following page. You have to select the appropriate Internet access type **according to the information from your ISP**. For example, you should select PPPoE mode if the ISP provides you PPPoE interface. In addition, the field of **For ADSL Only** will be available only when ADSL is detected. Then click **Next** for next step.

Quick Start Wizard

Connect to Internet

WAN 1	
Protocol	<input type="text" value="MPoA / Static or Dynamic IP"/>
For ADSL Only:	
Encapsulation	<input type="text" value="1483 Bridged IP LLC"/>
VPI	<input type="text" value="0"/> <input type="button" value="Auto detect"/>
VCI	<input type="text" value="88"/>
Fixed IP	<input checked="" type="radio"/> Yes <input type="radio"/> No(Dynamic IP)
IP Address	<input type="text" value="192.16.20.86"/>
Subnet Mask	<input type="text" value="255.255.255.0"/>
Default Gateway	<input type="text" value="192.16.20.1"/>
Primary DNS	<input type="text" value="8.8.4.4"/>
Second DNS	<input type="text" value="168.95.192.1"/>

PPPoE/PPPoA

1. Choose **WAN1** as WAN Interface and click the **Next** button; you will get the following page.

Quick Start Wizard

Connect to Internet

WAN 1	
Protocol	PPPoE / PPPoA
For ADSL Only:	
Encapsulation	PPPoE LLC/SNAP
VPI	0 <input type="button" value="Auto detect"/>
VCI	88
Fixed IP	<input checked="" type="radio"/> Yes <input type="radio"/> No(Dynamic IP)
IP Address	192.16.20.86
Subnet Mask	255.255.255.0
Default Gateway	192.16.20.1
Primary DNS	8.8.4.4
Second DNS	168.95.192.1

2. After finished the above settings, simply click **Next**.

Quick Start Wizard

Set PPPoE / PPPoA

WAN 1	
Service Name (Optional)	2760
Username	84005755@hinet.net
Password	*****
Confirm Password	*****

3. Please manually enter the Username/Password provided by your ISP. Then click **Next** for viewing summary of such connection.

Quick Start Wizard

Please confirm your settings:

WAN Interface:	WAN1
Physical Mode:	ADSL / VDSL2
VPI:	8
VCI:	35
Protocol / Encapsulation:	PPPoE / LLC
Fixed IP:	No
Primary DNS:	8.8.8.8
Secondary DNS:	8.8.4.4

4. Click **Finish**. A page of **Quick Start Wizard Setup OK!!!** will appear. Then, the system status of this protocol will be shown.
5. Now, you can enjoy surfing on the Internet.

MPoA / Static or Dynamic IP

1. Choose **WAN1** as WAN Interface and click the **Next** button; you will get the following page.

Quick Start Wizard

Connect to Internet

WAN 1	
Protocol	MPoA / Static or Dynamic IP
For ADSL Only:	
Encapsulation	1483 Bridged IP LLC
VPI	0 <input style="margin-left: 10px;" type="button" value=" Auto detect "/>
VCI	88
Fixed IP	<input checked="" type="radio"/> Yes <input type="radio"/> No(Dynamic IP)
IP Address	192.16.20.86
Subnet Mask	255.255.255.0
Default Gateway	192.16.20.1
Primary DNS	8.8.4.4
Second DNS	168.95.192.1

2. Please type in the IP address/mask/gateway information originally provided by your ISP. Then click **Next** for viewing summary of such connection.

Quick Start Wizard

Please confirm your settings:

WAN Interface:	WAN1
Physical Mode:	ADSL / VDSL2
VPI:	8
VCI:	35
Protocol / Encapsulation:	1483 Bridge LLC
Fixed IP:	No
Primary DNS:	8.8.8.8
Secondary DNS:	8.8.4.4

3. Click **Finish**. A page of **Quick Start Wizard Setup OK!!!** will appear. Then, the system status of this protocol will be shown.
4. Now, you can enjoy surfing on the Internet.

3.2.2 For WAN2 (Ethernet)

WAN2 is dedicated to physical mode in Ethernet. If you choose WAN2, please specify physical type. Then, click **Next**.

Quick Start Wizard

WAN Interface

WAN Interface:	WAN2 ▾
Display Name:	<input type="text"/>
Physical Mode:	Ethernet
Physical Type:	Auto negotiation ▾
VLAN Tag insertion	Disable ▾

On the next page as shown below, please select the appropriate Internet access type according to the information from your ISP. For example, you should select PPPoE mode if the ISP provides you PPPoE interface. Then click **Next** for next step.

PPPoE

1. Choose **WAN2** as the WAN Interface and click the **Next** button. The following page will be open for you to specify Internet Access Type.

Quick Start Wizard

Connect to Internet

WAN 2
Select one of the following Internet Access types provided by your ISP.

- PPPoE
- PPTP
- Static IP
- DHCP

2. Click **PPPoE** as the Internet Access Type. Then click **Next** to continue.

Quick Start Wizard

PPPoE Client Mode

WAN 2

Enter the user name and password provided by your ISP.

Service Name (Optional)	2760
Username	84005657@hinet.net
Password	*****
Confirm Password	*****

3. Please manually enter the Username/Password provided by your ISP. Click **Next** for viewing summary of such connection.

Quick Start Wizard

Please confirm your settings:

WAN Interface:	WAN2
Physical Mode:	Ethernet
Physical Type:	Auto negotiation
Internet Access:	PPPoE

Click **Back** to modify changes if necessary. Otherwise, click **Finish** to save the current settings and restart the Vigor router.

4. Click **Finish**. A page of **Quick Start Wizard Setup OK!!!** will appear. Then, the system status of this protocol will be shown.
5. Now, you can enjoy surfing on the Internet.

PPTP

1. Choose **WAN2** as the WAN Interface and click the **Next** button. The following page will be open for you to specify Internet Access Type.

Quick Start Wizard

Connect to Internet

WAN 2
Select one of the following Internet Access types provided by your ISP.

PPPoE
 PPTP
 Static IP
 DHCP

2. Click **PPTP** as the Internet Access Type. Then click **Next** to continue.

Quick Start Wizard

PPTP Client Mode

WAN 2
Enter the username, password, WAN IP configuration and PPTP server IP provided by your ISP.

Username

Password

Confirm Password

WAN IP Configuration

Obtain an IP address automatically
 Specify an IP address

IP Address

Subnet Mask

Gateway

Primary DNS

Second DNS

PPTP Server

3. Please type in the IP address/mask/gateway information originally provided by your ISP. Then click **Next** for viewing summary of such connection.

Quick Start Wizard

Please confirm your settings:

WAN Interface:	WAN2
Physical Mode:	Ethernet
Physical Type:	Auto negotiation
Internet Access:	PPTP

Click **Back** to modify changes if necessary. Otherwise, click **Finish** to save the current settings and restart the Vigor router.

4. Click **Finish**. A page of **Quick Start Wizard Setup OK!!!** will appear. Then, the system status of this protocol will be shown.
5. Now, you can enjoy surfing on the Internet.

Static IP

1. Choose **WAN2** as the WAN Interface and click the **Next** button. The following page will be open for you to specify Internet Access Type.

Quick Start Wizard

Connect to Internet

WAN 2
Select one of the following Internet Access types provided by your ISP.

- PPPoE
- PPTP
- Static IP
- DHCP

2. Click **Static IP** as the Internet Access type. Simply click **Next** to continue.

Quick Start Wizard

Static IP Client Mode

WAN 2
Enter the Static IP configuration provided by your ISP.

WAN IP	<input type="text" value="10.39.0.13"/>
Subnet Mask	<input type="text" value="255.255.255.0"/>
Gateway	<input type="text" value="10.39.0.1"/>
Primary DNS	<input type="text" value="8.8.8.8"/>
Secondary DNS	<input type="text" value="8.8.4.4"/> (optional)

3. Please type in the IP address information originally provided by your ISP. Then click **Next** for next step.

Quick Start Wizard

Please confirm your settings:

WAN Interface:	WAN2
Physical Mode:	Ethernet
Physical Type:	Auto negotiation
Internet Access:	Static IP

Click **Back** to modify changes if necessary. Otherwise, click **Finish** to save the current settings and restart the Vigor router.

4. Click **Finish**. A page of **Quick Start Wizard Setup OK!!!** will appear. Then, the system status of this protocol will be shown.
5. Now, you can enjoy surfing on the Internet.

DHCP

1. Choose **WAN2** as WAN Interface and click the **Next** button. The following page will be open for you to specify Internet Access Type.

Quick Start Wizard

Connect to Internet

WAN 2
Select one of the following Internet Access types provided by your ISP.

- PPPoE
- PPTP
- Static IP
- DHCP

2. Click **DHCP** as the Internet Access type. Simply click **Next** to continue.

Quick Start Wizard

DHCP Client Mode

WAN 2
If your ISP requires you to enter a specific host name or specific MAC address, please enter it in.

Host Name (optional)

MAC - - - - - (optional)

3. After finished the settings above, click **Next** for viewing summary of such connection.

Quick Start Wizard

Please confirm your settings:

WAN Interface:	WAN2
Physical Mode:	Ethernet
Physical Type:	Auto negotiation
Internet Access:	DHCP

Click **Back** to modify changes if necessary. Otherwise, click **Finish** to save the current settings and restart the Vigor router.

4. Click **Finish**. A page of **Quick Start Wizard Setup OK!!!** will appear. Then, the system status of this protocol will be shown.
5. Now, you can enjoy surfing on the Internet.

3.2.3 For WAN3 (USB)

WAN3 is dedicated to physical mode in USB. If WAN3 is selected, it is not necessary for you to type any information for such connection.

1. Choose **WAN3** as WAN Interface.

Quick Start Wizard

WAN Interface

WAN Interface:	WAN3 ▾
Display Name:	<input type="text"/>
Physical Mode:	USB

2. Then, click **Next** for getting the following page. Choose 3G/4G USB Modem (PPP mode) or 4G USB Modem (DHCP mode) according to the modem you use.

Quick Start Wizard

Connect to Internet

WAN 3

Internet Access :	3G/4G USB Modem(PPP mode) ▾
3G/4G USB Modem(PPP mode)	3G/4G USB Modem(PPP mode)
	4G USB Modem(DHCP mode)
SIM PIN code	<input type="text"/>
Modem Initial String	AT&FE0V1X1 &D2&C1S0=0
	(Default:AT&FE0V1X1&D2&C1S0=0)
APN Name	<input type="text"/> <input data-bbox="1074 1512 1181 1538" type="button" value=" Apply "/>

3. Then, click **Next** for viewing summary of such connection.

Quick Start Wizard

Please confirm your settings:

WAN Interface:	WAN3
Physical Mode:	USB
Internet Access:	DHCP

Click **Back** to modify changes if necessary. Otherwise, click **Finish** to save the current settings and restart the Vigor router.

4. Click **Finish**. A page of **Quick Start Wizard Setup OK!!!** will appear. Then, the system status of this protocol will be shown.
5. Now, you can enjoy surfing on the Internet.

3.3 Wireless Configuration



For the user of Viogr2760, please skip this section.

For operating Viogr2760n/Viogr2760Vn well, it is necessary for you to set the wireless LAN settings for using wireless function. Please read the following section carefully for configuring the settings for this router.

(The default value of Frequency Domain was set by factory depends on the reselling region.)

3.3.1 Basic Wireless LAN Concept

In an Infrastructure Mode of wireless network, Vigor wireless router plays a role as an **Access Point (AP)** connecting to lots of wireless clients or Stations (STA). All the STAs (clients) will share the same Internet connection with other wired hosts via Vigor wireless router.

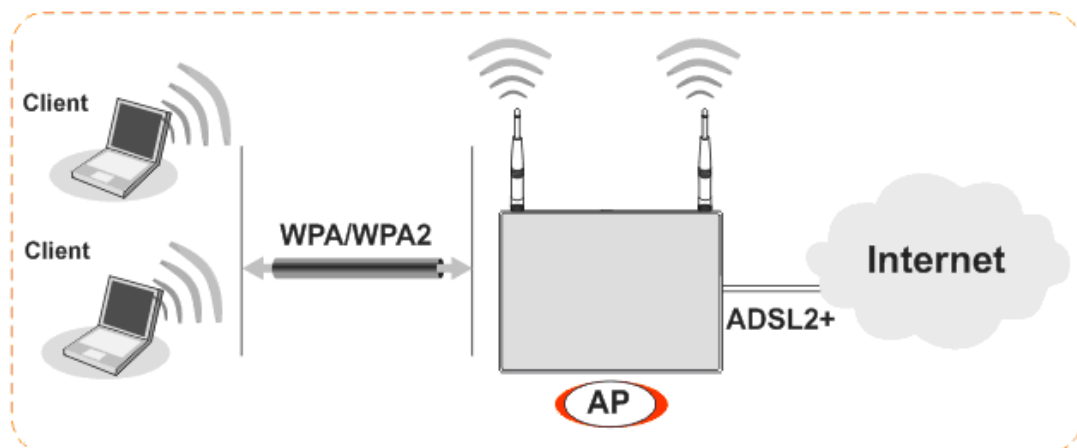

3.3.2 Wireless Wizard

The wireless wizard allows you to configure settings specified for a host AP (for home use or internal use for a company) and specified for a guest AP (for any wireless clients accessing into Internet).

Follow the steps listed below:

1. Open **Wireless Wizard**.

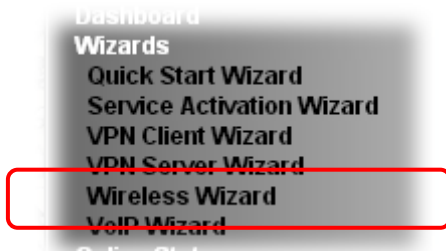

2. The screen of wireless wizard will be shown as follows. This page will be used for internal users in a company or your home.

Wireless Wizard

Host AP Configuration

Name:	<input type="text" value="DrayTek"/>
Mode:	<input type="text" value="Mixed(11b+11g+11n)"/>
Channel:	<input type="text" value="Channel 6, 2437MHz"/>
Password:	<input type="password" value="*****"/>

Note:The host AP configured here will be used for home or internal company use.

3. After typing the required information, click **Next**. The settings in the page limit the wireless station (guest) accessing into Internet but not being allowed to share the LAN network and VPN connection.

Wireless Wizard

Guest AP Configuration

Enable Disable

Name:

Password:

Rate Control: Enable Upload kbps Download kbps

Note: The configured guest AP will not be able to access VPN connections or communicate with wireless devices connecting to the router's other APs. The guest AP will be configured to be not able to connect to LAN interfaces also. However if the VLAN configurations were already made, then the guest AP will be able to connect to LAN ports belonging in the same VLAN group. This AP interface is by default configured for Internet access only.

4. After typing the required information, click **Next**.
5. The following page will display the configuration summary for wireless setting.

4. Trouble Shooting

This section will guide you to solve abnormal situations if you cannot access into the Internet after installing the router and finishing the web configuration. Please follow sections below to check your basic installation status stage by stage.

- Checking if the hardware status is OK or not.
- Checking if the network connection settings on your computer are OK or not.
- Pinging the router from your computer.
- Checking if the ISP settings are OK or not.
- Backing to factory default setting if necessary.

If all above stages are done and the router still cannot run normally, it is the time for you to contact your dealer for advanced help.

4.1 Checking If the Hardware Status Is OK or Not

Follow the steps below to verify the hardware status.

1. Check the power line and LAN cable connections. Refer to “**2.1 Hardware Installation**” for details.
2. Turn on the router. Make sure the **ACT LED** blink once per second and the correspondent **LAN LED** is bright.



3. If not, it means that there is something wrong with the hardware status. Simply back to “**2.1 Hardware Installation**” to execute the hardware installation again. And then, try again.

4.2 Checking If the Network Connection Settings on Your Computer Is OK or Not

Sometimes the link failure occurs due to the wrong network connection settings. After trying the above section, if the link is still failed, please do the steps listed below to make sure the network connection settings is OK.

For Windows



The example is based on Windows XP. As to the examples for other operation systems, please refer to the similar steps or find support notes in www.draytek.com.

1. Open **All Programs>>Getting Started>>Control Panel**. Click **Network and Sharing Center**.



2. In the following window, click **Change adapter settings**.

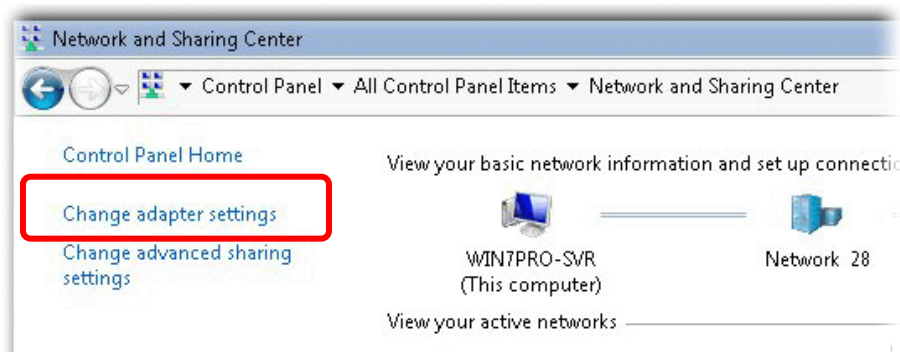

3. Icons of network connection will be shown on the window. Right-click on **Local Area Connection** and click on **Properties**.

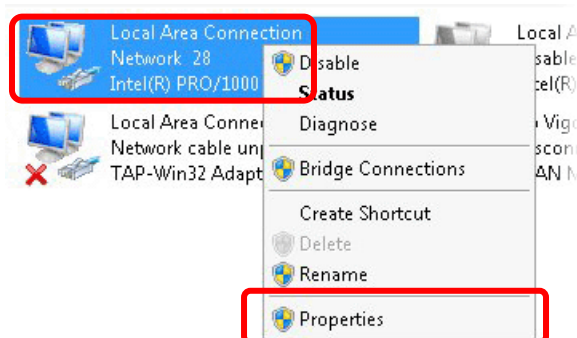

4. Select **Internet Protocol Version 4 (TCP/IP)** and then click **Properties**.

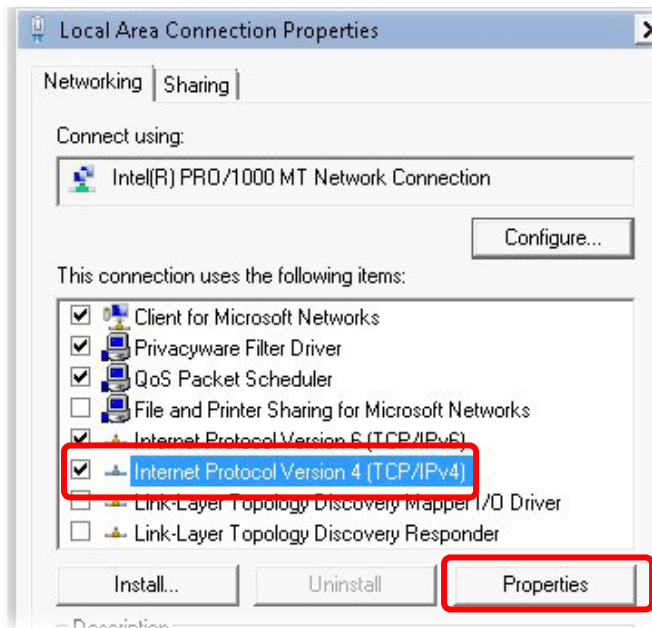

5. Select **Obtain an IP address automatically** and **Obtain DNS server address automatically**. Finally, click **OK**.

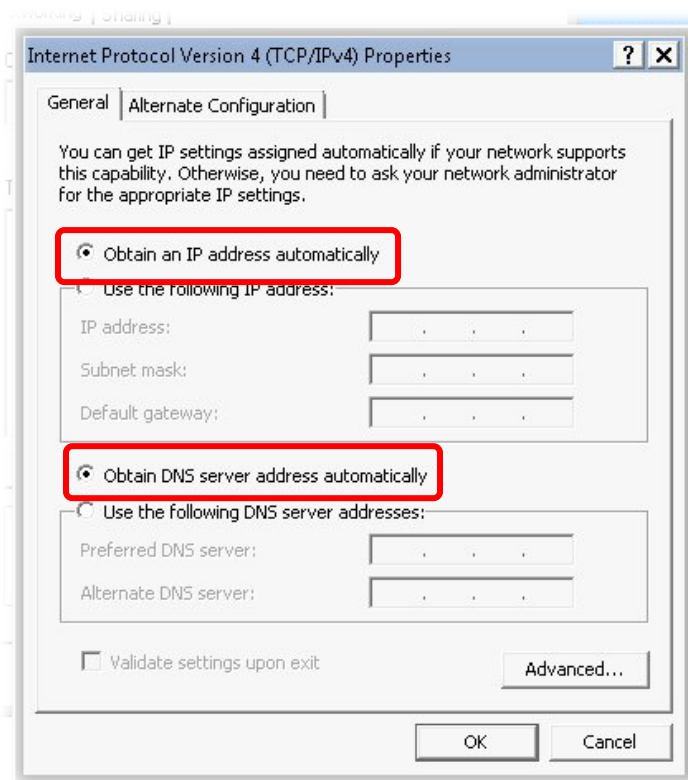

For Mac OS

1. Double click on the current used Mac OS on the desktop.
2. Open the **Application** folder and get into **Network**.
3. On the **Network** screen, select **Using DHCP** from the drop down list of Configure IPv4.

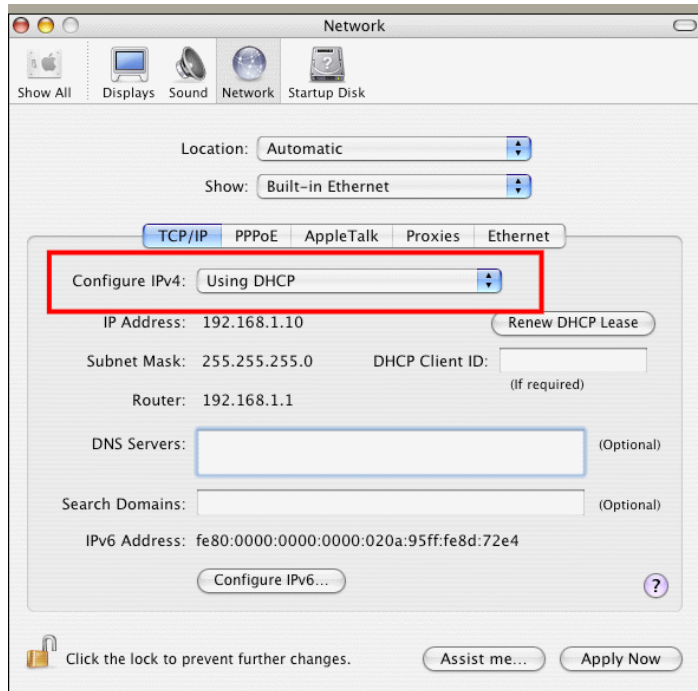

4.3 Pinging the Router from Your Computer

The default gateway IP address of the router is 192.168.1.1. For some reason, you might need to use “ping” command to check the link status of the router. **The most important thing is that the computer will receive a reply from 192.168.1.1.** If not, please check the IP address of your computer. We suggest you setting the network connection as **get IP automatically**. (Please refer to the section 4.2)

Please follow the steps below to ping the router correctly.

For Windows

1. Open the **Command Prompt** window (from **Start menu**> **Run**).
2. Type **command** (for Windows 95/98/ME) or **cmd** (for Windows NT/2000/XP/Vista/7). The DOS command dialog will appear.

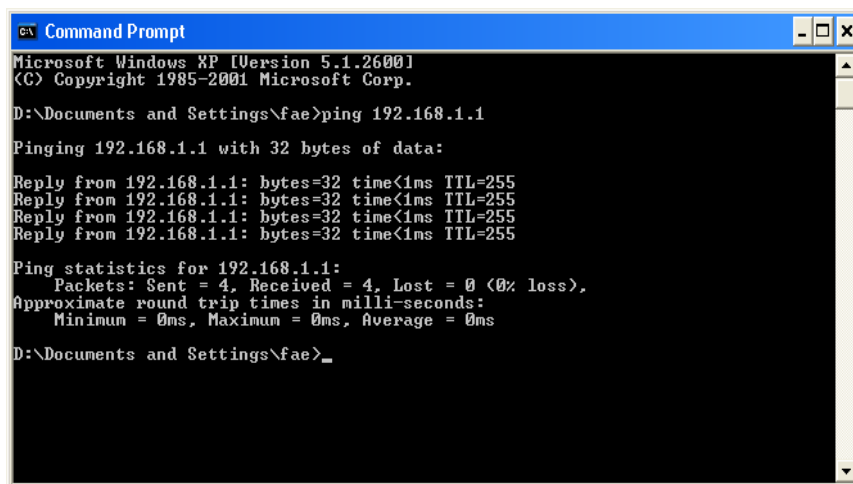

```
Microsoft Windows XP [Version 5.1.2600]
(C) Copyright 1985-2001 Microsoft Corp.

D:\Documents and Settings\fae>ping 192.168.1.1

Pinging 192.168.1.1 with 32 bytes of data:

Reply from 192.168.1.1: bytes=32 time<1ms TTL=255
Reply from 192.168.1.1: bytes=32 time<1ms TTL=255
Reply from 192.168.1.1: bytes=32 time<1ms TTL=255
Reply from 192.168.1.1: bytes=32 time<1ms TTL=255

Ping statistics for 192.168.1.1:
    Packets: Sent = 4, Received = 4, Lost = 0 (0% loss),
    Approximate round trip times in milli-seconds:
        Minimum = 0ms, Maximum = 0ms, Average = 0ms

D:\Documents and Settings\fae>_
```

3. Type **ping 192.168.1.1** and press [Enter]. If the link is OK, the line of “**Reply from 192.168.1.1:bytes=32 time<1ms TTL=255**” will appear.
4. If the line does not appear, please check the IP address setting of your computer.

For Mac OS (Terminal)

1. Double click on the current used Mac OS on the desktop.
2. Open the **Application** folder and get into **Utilities**.
3. Double click **Terminal**. The Terminal window will appear.
4. Type **ping 192.168.1.1** and press [Enter]. If the link is OK, the line of “**64 bytes from 192.168.1.1: icmp_seq=0 ttl=255 time=xxxx ms**” will appear.

```

Terminal - bash - 80x24
Last login: Sat Jan 3 02:24:18 on ttty1
Welcome to Darwin!
Vigor10:~ draytek$ ping 192.168.1.1
PING 192.168.1.1 (192.168.1.1): 56 data bytes
64 bytes from 192.168.1.1: icmp_seq=0 ttl=255 time=0.755 ms
64 bytes from 192.168.1.1: icmp_seq=1 ttl=255 time=0.697 ms
64 bytes from 192.168.1.1: icmp_seq=2 ttl=255 time=0.716 ms
64 bytes from 192.168.1.1: icmp_seq=3 ttl=255 time=0.731 ms
64 bytes from 192.168.1.1: icmp_seq=4 ttl=255 time=0.72 ms
^C
--- 192.168.1.1 ping statistics ---
5 packets transmitted, 5 packets received, 0% packet loss
round-trip min/avg/max = 0.697/0.723/0.755 ms
Vigor10:~ draytek$

```

4.4 Checking If the ISP Settings are OK or Not

Open **WAN>>Internet** and check whether the ISP settings are set correctly.

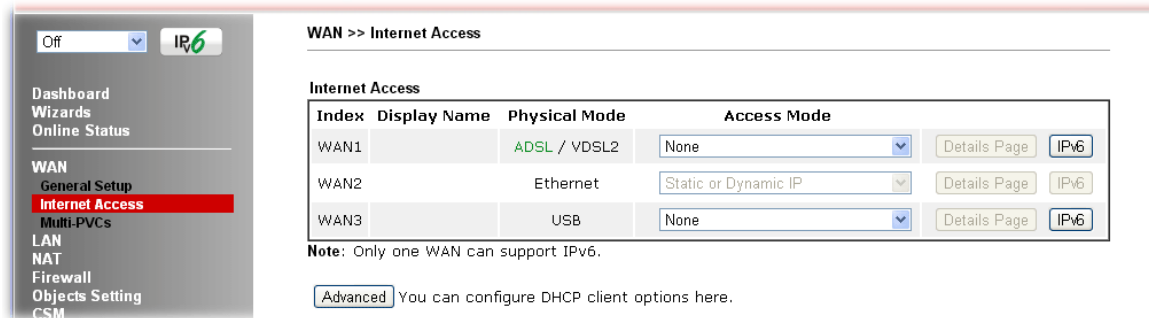

4.5 Problems for 3G Network Connection

When you have trouble in using 3G network transmission, please check the following:

Check if USB LED lights on or off

You have to wait about 15 seconds after inserting 3G USB Modem into your Vigor2760. Later, the USB LED will light on which means the installation of USB Modem is successful. If the USB LED does not light on, please remove and reinsert the modem again. If it still fails, restart Vigor2760.

USB LED lights on but the network connection does not work

Check the PIN Code of SIM card is disabled or not. Please use the utility of 3G USB Modem to disable PIN code and try again. If it still fails, it might be the compliance problem of system. Please open DrayTek Syslog Tool to capture the connection information (WAN Log) and send the page (similar to the following graphic) to the service center of DrayTek.

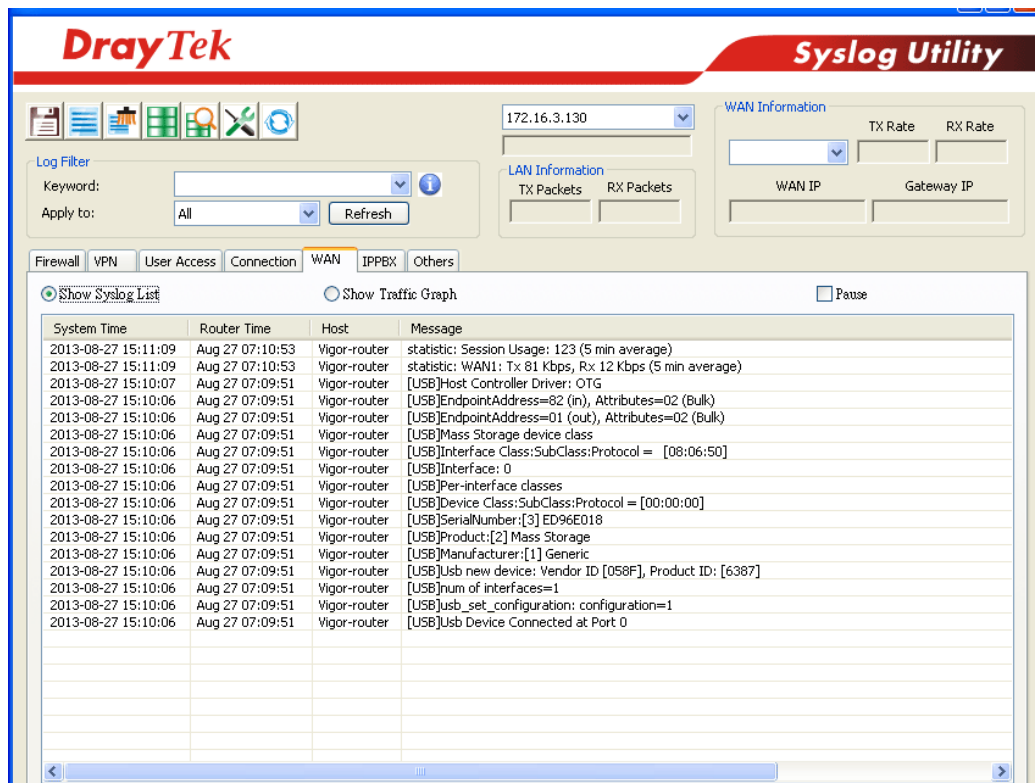

Transmission Rate is not fast enough

Please connect your Notebook with 3G USB Modem to test the connection speed to verify if the problem is caused by Vigor2760. In addition, please refer to the manual of 3G USB Modem for LED Status to make sure if the modem connects to Internet via HSDPA mode. If you want to use the modem indoors, please put it on the place near the window to obtain better signal receiving.

4.6 Backing to Factory Default Setting If Necessary

Sometimes, a wrong connection can be improved by returning to the default settings. Try to reset the router by software or hardware.



Warning: After pressing **factory default setting**, you will lose all settings you did before. Make sure you have recorded all useful settings before you pressing.

Software Reset

You can reset the router to factory default via Web page.

Open **System Maintenance**>> **Reboot System**. The following screen will appear. Choose **Using factory default configuration** and click **OK**. After few seconds, the router will return all the settings to the factory settings.

System Maintenance >> Reboot System

Reboot System

Do you want to reboot your router ?

Using current configuration
 Using factory default configuration

Reboot Now

Auto Reboot Time Schedule

Index(1-15) in **Schedule** Setup: , , ,

Note: Action and Idle Timeout settings will be ignored.

OK

Cancel

Hardware Reset

While the router is running (ACT LED blinking), press the **Factory Reset** button and hold for more than 5 seconds. When you see the **ACT LED** blinks rapidly, please release the button. Then, the router will restart with the default configuration.

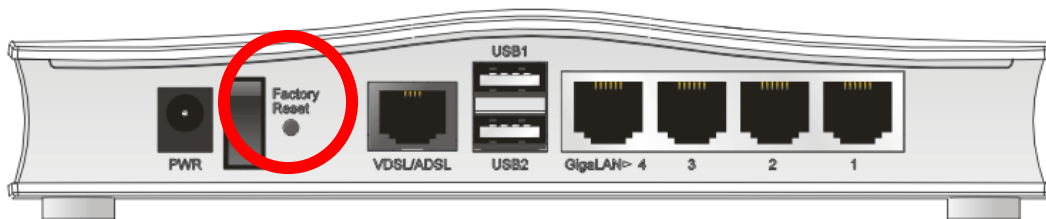

After restore the factory default setting, you can configure the settings for the router again to fit your personal request.

4.7 Contacting DrayTek

If the router still cannot work correctly after trying many efforts, please contact DrayTek for further help right away. For any questions, please feel free to send e-mail to support@draytek.com.