

EMC TEST REPORT
for
Mini Speed Dome Camera
Model No.: DH5100B1AP1T2B

of

Applicant: **DYNACOLOR, INC.**
Address: **No.116, Jou Tz Street, Neihu, Taipei 114, Taiwan**

Tested and Prepared

by

Worldwide Testing Services (Taiwan) Co., Ltd.

FCC Registration No.: 930600

Industry Canada filed test laboratory Reg. No. IC 5679A-1



Report No.: W6M20907-9921-E-11

6F, NO. 58, LANE 188, RUEY-KUANG RD., NEIHU TAIPEI 114, TAIWAN, R.O.C.
TEL: 886-2-66068877 FAX: 886-2-66068879 E-mail: wts@wts-lab.com



Worldwide Testing Services(Taiwan) Co., Ltd.

Details of applicant

Name : DYNACOLOR, INC.
Street : No.116, Jou Tz Street, Neihu,
Town : Taipei 114,
Country : Taiwan
Telephone : +886-2-2659-8898
Fax : +886-2-2659-8868

Description of tested equipment

Type of product : Mini Speed Dome Camera
Type identification : DH5100B1AP1T2B
Brand name : DYNACOLOR
Multi-listing model no. : DH510xxxxxxx (x=0~9, A~Z or space)
Power supply : 240 V

Date of testing processing

Date of receipt of test item : July 16, 2009
Date of test : from July 17, 2009 to July 31, 2009
Other Information : None

Manufacturer (if different from applicant)

Name : ./.
Street : ./.
Town : ./.
Country : ./.

Test Standards

EN 55022 Class B (2006+A1:2007), AS/NZS CISPR 22:2006
IEC/EN 61000-3-2 (2006), IEC/EN 61000-3-3 (2008)
EN 55024 (1998+A1 :2001+A2 :2003), (IEC/EN61000-4-2(1995+A1:1998+A2: 2001)/
-3(2006+A1:2008)/-4(2004)/-5(2006)/-6 (2007)/ -11(2004))

Technical responsibility for area of testing:

Tester:

Issue Date : July 31, 2009

July 31, 2009

Note:

1. The result of this test report is valid only in connection to the sample has been tested at the laboratory of Worldwide Testing Services (Taiwan) Co., Ltd.
2. This test report shall always be duplicated in full pages unless the written approval of the testing laboratory is obtained.

Registration number: W6M20907-9921-E-11



Worldwide Testing Services(Taiwan) Co., Ltd.

Testing laboratory

Location

Worldwide Testing Services (Taiwan) Co., Ltd.

OATS

No.5-1, Shuang Sing Village,
LiShuei Rd., Wanli Township,
Taipei County 207, Taiwan (R.O.C.)

Company

Worldwide Testing Services (Taiwan) Co., Ltd.

6F, NO. 58, LANE 188, RUEY-KUANG RD.

NEIHU, TAIPEI 114, TAIWAN R.O.C.

Tel : 886-2-66068877

Fax : 886-2-66068879

Details of accreditation status

Accredited testing laboratory

FCC filed test laboratory Reg. No. 930600

Industry Canada filed test laboratory Reg. No. IC5679A-1



Test location, where different from Worldwide Testing Services (Taiwan) Co., Ltd.

Name : ./.

Accredited number: ./.

Street : ./.

Town : ./.

Country : ./.

Telephone : ./.

Fax : ./.

Modification Information

No modification was made during the all test items been performed.

Registration number: W6M20907-9921-E-11



Electro - Magnetic Compatibility

Test – Result

1st test test after modification production test

Test Emission / Immunity			Done	Test passed	Test failed
Emission	Radiated Emission	EN 55022 Class B (2006+A1:2007)	<input checked="" type="checkbox"/>	<input checked="" type="checkbox"/>	<input type="checkbox"/>
Emission	Conducted Emission	EN 55022 Class B (2006+A1:2007)	<input checked="" type="checkbox"/>	<input checked="" type="checkbox"/>	<input type="checkbox"/>
Harmonics	Current Harmonics	IEC/EN 61000 - 3 - 2 (2006)	<input checked="" type="checkbox"/>	<input checked="" type="checkbox"/>	<input type="checkbox"/>
Flicker	Voltage Fluctuations	IEC/EN 61000 - 3 - 3 (2008)	<input checked="" type="checkbox"/>	<input checked="" type="checkbox"/>	<input type="checkbox"/>
ESD	Electrostatic Discharge	IEC/EN 61000 - 4 - 2 (1995+A1:1998+A2: 2001)	<input checked="" type="checkbox"/>	<input checked="" type="checkbox"/>	<input type="checkbox"/>
RF - Field	Radiated Immunity	IEC/EN 61000 - 4 - 3 (2006+A1:2008)	<input checked="" type="checkbox"/>	<input checked="" type="checkbox"/>	<input type="checkbox"/>
Burst	Electrical Fast Transients	IEC/EN 61000 - 4 - 4 (2004)	<input checked="" type="checkbox"/>	<input checked="" type="checkbox"/>	<input type="checkbox"/>
Surge	Transients comm.& diff.mode	IEC/EN 61000 - 4 - 5 (2006)	<input checked="" type="checkbox"/>	<input checked="" type="checkbox"/>	<input type="checkbox"/>
RF-common mode	RF continues conducted	IEC/EN 61000 - 4 - 6 (2007)	<input checked="" type="checkbox"/>	<input checked="" type="checkbox"/>	<input type="checkbox"/>
V-dips	Voltage dips and Interruption	IEC/EN 61000 - 4 - 11 (2004)	<input checked="" type="checkbox"/>	<input checked="" type="checkbox"/>	<input type="checkbox"/>

Registration number: W6M20907-9921-E-11



Worldwide Testing Services(Taiwan) Co., Ltd.

Test equipment utilized

No.	Test equipment	Type	Serial No.	Manufacturer	Cal. Date	Next Cal. Date
ETSTW-CE 001	EMI TEST RECEIVER	ESHS10	842121/013	R&S	2008/9/18	2009/9/17
ETSTW-CE 002	PREREULATOR MODE DC POWER SUPPLY	None	None	None	Function Test	
ETSTW-CE 003	AC POWER SOURCE	APS-9102	D161137	GW	Function Test	
ETSTW-CE 004	ZWEILEITER-V- NETZNACHBILDUNG TWO- LINE V-NETWORK	ESH3-Z5	840731/011	R&S	2009/3/27	2010/3/26
ETSTW-CE 005	Line-Impedance Stabilisation Network	NNBM 8126D	137	Schwarzbeck	2008/9/15	2009/9/14
ETSTW-CE 006	IMPULSBEGRENZER PULSE LIMITER	ESH3-Z2	100226	R&S	2009/5/9	2010/5/8
ETSTW-CE 008	ABSORBING CLAMP	MDS 21	3469	Schwarzbeck	2008/9/18	2009/9/17
ETSTW-CE 009	TEMP.&HUMIDITY CHAMBER	GTH-225-40-1P-U	MAA0305-009	GIANT FORCE	2009/7/21	2010/7/20
ETSTW-CE 015	CISPR 22 TWO BALANCED TELECOM PAIRS IMPEDANCE STABILIZATION NETWORK	FCC-TLISN-T8-02	20307	FCC	2008/9/22	2009/9/21
ETSTW-CE 016	TWO-LINE V-NETWORK	ENV216	100050	R&S	2008/9/24	2009/9/23
ETSTW-CS 003	COUPLING AND DECOUPLING NETWORK	CDN T400	19820	SCHAFFNER	2008/9/16	2009/9/15
ETSTW-CS 004	COUPLING AND DECOUPLING NETWORK	CDN M016	20053	SCHAFFNER	2008/8/23	2009/8/22
ETSTW-CS 005	RF Power Amplifier	100A250A	306547	AR	Function Test	
ETSTW-CS 008	6 dB Attenuator	HFP-5100-3/06 N M/F	2010876106	None	2009/5/9	2010/5/8
ETSTW-RE 002	Function Generator	33220A	MY43004982	Agilent	2007/10/12	2009/10/11
ETSTW-RE 003	EMI TEST RECEIVER	ESI 26	831438/001	R&S	2008/10/8	2009/10/7
ETSTW-RE 004	EMI TEST RECEIVER	ESI 40	832427/004	R&S	2008/9/22	2009/9/21
ETSTW-RE 005	EMI TEST RECEIVER	ESVS10	843207/020	R&S	2008/9/18	2009/9/17
ETSTW-RE 011	PROGRAMMABLE LINEAR POWER SUPPLY	LPS-305	30503070165	MOTECH	Function Test	
ETSTW-RE 017	Log-Periodic Antenna	HL025	352886/001	R&S	2009/5/4	2010/5/3
ETSTW-RE 018	MICROWAVE HORN ANTENNA	AT4560	27212	AR	2008/10/27	2009/10/26
ETSTW-RE 020	MICROWAVE HORN ANTENNA	AT4002A	306915	AR	Function Test	
ETSTW-RE 021	SWEEP GENERATOR	SWM05	835130/010	R&S	2008/8/27	2009/8/26
ETSTW-RE 028	Log-Periodic Dipole Array Antenna	3148	34429	EMCO	2009/4/15	2010/4/14
ETSTW-RE 029	Biconical Antenna	3109	33524	EMCO	2009/4/15	2010/4/14
ETSTW-RE 030	Double-Ridged Guide Horn Antenna	3117	00035224	EMCO	2009/3/23	2010/3/22
ETSTW-RE 032	Millivoltmeter	URV 55	849086/013	R&S	2008/9/1	2009/8/31
ETSTW-RE 033	WaveRunner 6000A Serise Oscilloscope	WAVERUNNER 6100A	LCRY0604P14508	LeCroy	2009/6/15	2010/6/14
ETSTW-RE 034	Power Sensor	URV5-Z4	839313/006	R&S	2008/9/1	2009/8/31
ETSTW-RE 042	Biconical Antenna	HK116	100172	R&S	2009/1/8	2011/1/7
ETSTW-RE 043	Log-Periodic Dipole Antenna	HL223	100166	R&S	2009/5/5	2010/5/4

Registration number: W6M20907-9921-E-11



Worldwide Testing Services(Taiwan) Co., Ltd.

ETSTW-RE 044	Log-Periodic Antenna	HL050	100094	R&S	2009/5/21	2010/5/20
ETSTW-RE 047	ESA-E SERIES SPECTRUM ANALYZER	E4445A	MY46181369	Agilent	2009/6/15	2010/6/14
ETSTW-RE 048	Triple Loop Antenna	HXYZ 9170	HXYZ 9170-134	Schwarzbeck	2008/9/1	2009/8/31
ETSTW-RF 049	TRILOG Super Broadband test Antenna	VII.B 9160	9160-3185	Schwarzbeck	2009/4/14	2011/4/13
ETSTW-RE 055	SPECTRUM ANALYZER	FSU 26	200074	R&S	2009/6/10	2010/6/09
ETSTW-RE 064	Bluetooth Test Set	MT8852B-042	6K00005709	Anritsu	2008/9/1	2009/8/31
ETSTW-RE 065	Amplifier	AMF-6F-18002650-25-10P	941608	MITEQ	2009/4/21	2010/4/20
ETSTW-RE 072	CELL SITE TEST SET	8921A	3339A00375	HP	2008/10/28	2009/10/27
ETSTW-RE 073	Power Meter	N1911A	MY45100769	Agilent	2009/1/9	2011/1/8
ETSTW-RE 074	Power Sensor	N1921A	MY45241198	Agilent	2009/1/9	2011/1/8
ETSTW-RE 091	Match Pad	MDCS1500	None	WOKEN	2008/10/9	2009/10/8
ETSTW-RE 092	Match Pad	MDCS1510	None	WOKEN	2008/10/9	2009/10/8
ETSTW-RE 093	LUMPED ELEMENT POWER DIVIDER	PL2-10	146	MCLI	2009/3/6	2010/3/5
ETSTW-RE 094	Precision Coaxial Termination	HP 909F	03941	Agilent	2008/12/19	2009/12/18
ETSTW-RE 095	Digital Thermo-Hygro Meter	0410	01	WISEWIND	2009/3/24	2010/3/23
ETSTW-RE 096	SIGNAL GENERATOR	SMIQ 03B	102274	R&S	2009/6/5	2010/6/4
ETSTW-RE 097	GPS SIGNAL GENERATOR	GSG-L1	06-0507-0311	Naviva	NCR	
ETSTW-EMI 001	HARMONICS 1000	HAR1000-1P	093	EMC-PARTNER	2008/9/2	2009/9/1
ETSTW-EMS 001	BASELSTRASSE 160 CH-4242 LAUFEN	CN-EFT1000	354	EMC-PARTNER	Function Test	
ETSTW-EMS 002	Frequency Converter	YF-6020	0308014	None	Function Test	
ETSTW-EMS 003	EMC Immunity Test System	TRA2000IN6	579	EMC-PARTNER	2009/4/21	2010/4/20
ETSTW-EMS 009	Magnetic Field Antenna	MF1000-1	104	EMC-PARTNER	Function Test	
ETSTW-EMS 010	Coupling De-coupling Network	CDN-UTP8	014	EMC-PARTNER	2009/4/21	2010/4/20
ETSTW-EMS 011	Calibration Fixture	F-203I-CF-23MM	451	FCC	2009/6/6	2010/6/5
ETSTW-EMS 012	EM Injection Clamp	F-203I-23MM	476	FCC	2009/6/6	2010/6/5
ETSTW-EMS 014	Digital Thermo-Hygro Meter	0507	02	WISEWIND	2008/9/23	2009/9/22
ETSTW-EMS 015	HVAC Trms Power Clamp Meter	3079K	070800649	TES	2008/10/13	2009/10/12
ETSTW-EMS 016	EMF Tester	1390	071208732	TES	2008/10/15	2009/10/14
ETSTW-EMS 017	Multimeter	DM-1220	518614	HOLA	2008/8/28	2009/8/27
ETSTW-EMS 018	ESD Simulator	ESD2000	296	EMC-PARTNER	2009/4/21	2010/4/20
ETSTW-RS 003	RF Power Amplifier	30S1G3	306933	AR	Function Test	
ETSTW-RS 004	RF Power Amplifier	150W1000	307009	AR	Function Test	
ETSTW-RS 005	Electric Field Probe Type 8.3	EMR-20	AF-0016	WG	2008/8/26	2009/8/25
ETSTW-RS 007	14" COLOR VIDEO MONITOR	HS-CM145A	0512011548	None	Function Test	
ETSTW-RS 009	SIGNAL GENERATOR	8648C	3642U01656	HP	2009/3/5	2010/3/4
ETSTW-GSM 002	Universal Radio Communication Tester	CMU 200	109439	R&S	2008/9/23	2009/9/22

Registration number: W6M20907-9921-E-11



Worldwide Testing Services(Taiwan) Co., Ltd.

ETSTW-GSM 023	Power Divider	4901.19.A	None	SUHNER	2008/9/22	2009/9/21
ETSTW-Cable 001	Microwave Cable	SUCOFLEX 104	238094	HUBER+SUHNER	2008/9/22	2009/9/21
ETSTW-Cable 002	Microwave Cable	SUCOFLEX 104	238093	HUBER+SUHNER	2008/9/22	2009/9/21
ETSTW-Cable 003	Microwave Cable	SUCOFLEX 104	209953	HUBER+SUHNER	2008/9/22	2009/9/21
ETSTW-Cable 006	Microwave Cable	SUCOFLEX 104	279067	HUBER+SUHNER	2009/3/6	2010/3/5
ETSTW-Cable 007	BNC Cable	Cable 33	None	JYE BAO CO.,LTD.	2009/3/6	2010/3/5
ETSTW-Cable 009	BNC Cable	5 M BNC Cable	None	JYE BAO CO.,LTD.	2009/3/6	2010/3/5
ETSTW-Cable 010	BNC Cable	5 M BNC Cable	None	JYE BAO CO.,LTD.	2009/3/6	2010/3/5
ETSTW-Cable 011	BNC Cable	BNC Cable 1	None	JYE BAO CO.,LTD.	2008/8/21	2009/8/20
ETSTW-Cable 012	BNC Cable	BNC Cable 2	None	JYE BAO CO.,LTD.	2008/8/21	2009/8/20
ETSTW-Cable 013	Microwave Cable	SUCOFLEX 104	232345	HUBER+SUHNER	2009/3/6	2010/3/5
ETSTW-Cable 016	BNC Cable	Switch Box	B Cable 1	Schwarz beck	2009/3/6	2010/3/5
ETSTW-Cable 017	BNC Cable	X Cable	B Cable 2	Schwarz beck	2009/3/6	2010/3/5
ETSTW-Cable 018	BNC Cable	Y Cable	B Cable 3	Schwarz beck	2009/3/6	2010/3/5
ETSTW-Cable 019	BNC Cable	Z Cable	B Cable 4	Schwarz beck	2009/3/6	2010/3/5
ETSTW-Cable 022	N TYPE Cable	OATS Cable 3	0002	JYE BAO CO.,LTD.	2009/3/6	2010/3/5
WTSTW-SW 001	EMI TEST SOFTWARE	Harmonics-1000	None	EMC PARTNER	HARCS Version 4.16 Firmware Version 2.18	
WTSTW-SW 002	EMI TEST SOFTWARE	EZ EMC	None	Farad	Version ETS-03A1	
WTSTW-SW 003	EMS TEST SOFTWARE	i2	None	AUDIX	Version 3.2007-8-17b	

Registration number: W6M20907-9921-E-11



Spurious Emission (EN 55022)

Test Equipment

- a) Biconical Antenna (HK116)
For your reference please find it in our test equipment list at page 4 to 6 as number : ETSTW-RE 042
- b) Log-Periodic Dipole Antenna (HL223)
For your reference please find it in our test equipment list at page 4 to 6 as number : ETSTW-RE 043
- c) TRILOG Super Broadband test Antenna (VULB 9160)
For your reference please find it in our test equipment list at page 4 to 6 as number : ETSTW-RE 049
- d) SIGNAL GENERATOR (8648C)
For your reference please find it in our test equipment list at page 4 to 6 as number : ETSTW-RS 009
- e) EMI TEST RECEIVER (ESI 26)
For your reference please find it in our test equipment list at page 4 to 6 as number : ETSTW-RE 003
- f) EMI TEST RECEIVER (ESI 40)
For your reference please find it in our test equipment list at page 4 to 6 as number : ETSTW-RE 004
- g) Log-Periodic Antenna (HL025)
For your reference please find it in our test equipment list at page 4 to 6 as number : ETSTW-RE 017

Test Procedures

- Test configuration

The test configuration corresponds to the standard EN 55022. The equipment under test is placed on a non metallic table with 0.8m height. The power supply and the RF connection points are close to the equipment under test at the floor inside a connection box. The cables to this connection box are shielded and below the double floor. The receiving antenna is placed in a height at 1.0m to 4.0m, in a distance of 10m. The measurement receiver is placed in a special room. (see picture 1) The observation of the equipment under test is realized by 3 video cameras and by a microphone.

- Test parameters and marginal conditions

The test is carried out with horizontal and vertical polarisation of the antenna in a frequency range of 30 MHz to 2000 MHz. Further information please find in the test protocol.

Radiated Emission according to EN 55022

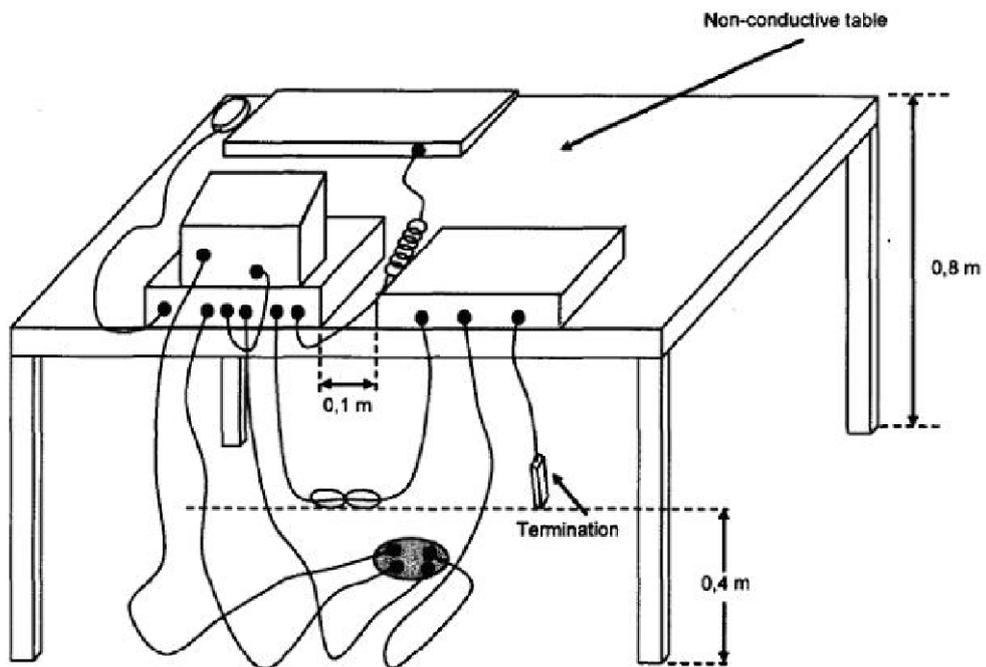

Picture 1



Conducted Emission (EN 55022)

Test Equipment

- a) ZWEILEITER-V-NETZNACHBILDUNG TWO-LINE V-NETWORK (ESH3-Z5)
For your reference please find it in our test equipment list at page 4 to 6 as number : ETSTW-CE 004
- b) IMPULS-BEGRENZER PULSE LIMITER (ESH3-Z2)
For your reference please find it in our test equipment list at page 4 to 6 as number : ETSTW-CE 006
- c) EMI TEST RECEIVER (ESHS10)
For your reference please find it in our test equipment list at page 4 to 6 as number : ETSTW-CE 001
- d) AC Power Source (APS-9102)
For your reference please find it in our test equipment list at page 4 to 6 as number : ETSTW-CE 003
- e) CISPR 22 Two Balanced Telecom Pairs Impedance Stabilization Network (FCC-TLISN-T8-02)
For your reference please find it in our test equipment list at page 4 to 6 as number : ETSTW-CE 015
- f) Line-Impedance Stabilisation Network (NNBM 8126D)
For your reference please find it in our test equipment list at page 4 to 6 as number : ETSTW-CE 005

Test Procedures

- **Test configuration**

The test configuration is contained inside of a shielded chamber and corresponds to the standard EN 55022. The equipment under test is placed in the facility on a wooden table 0.8m height. The equipment under test is connected with the artificial mains network (AMN) in a distance of 0.8m and also 0.8m from other subassembly and metallic area. (see picture 2) The observation of the equipment under test is realized by 3 video cameras and by a microphone.

- **Test parameters and marginal conditions**

The test is carried out with nominal impedance by $50\Omega / 50\mu\text{H}$ of the AMN in a frequency range 150 kHz to 30 MHz. Further information please find in test report.

Conducted Emission according to EN 55022

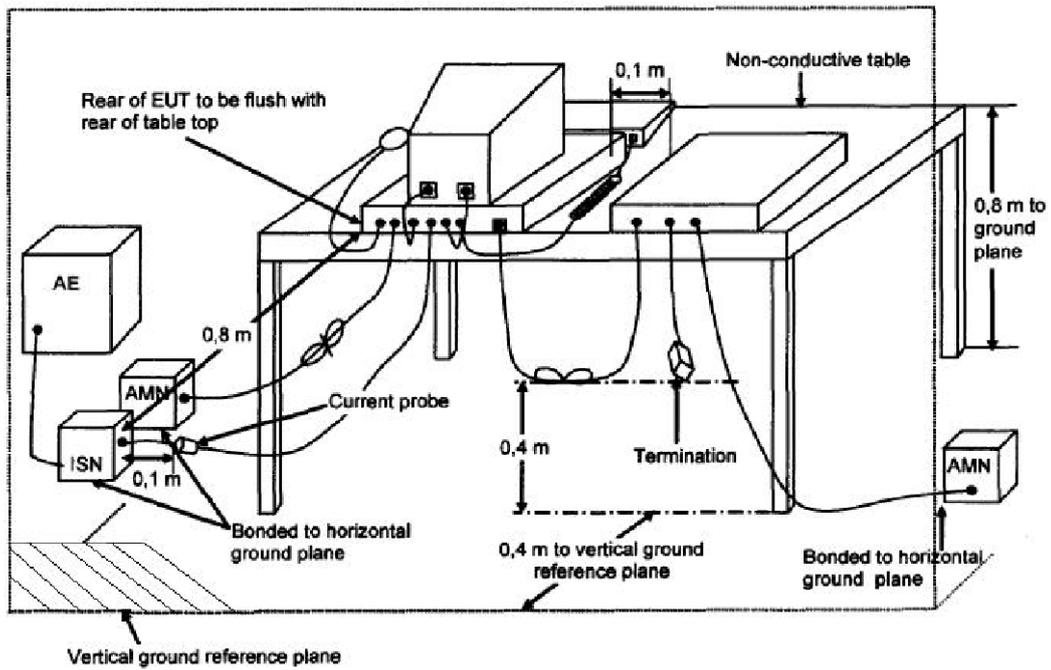

Picture 2



Worldwide Testing Services(Taiwan) Co., Ltd.

Harmonic Current Emission /Voltage Fluctuations and Flicker (IEC/EN 61000-3-2/-3)

Test Equipment

a) HARMONICS 1000 (HAR 1000-1P)

For your reference please find it in our test equipment list at page 4 to 6 as number : ETSTW-EMI 001

b) Frequency Converter (YF-6020)

For your reference please find it in our test equipment list at page 4 to 6 as number : ETSTW-EMS 002

Test Procedures

- Test configuration

The test configuration is correspondence to the standard IEC/EN 61000-3-2/-3. The equipment under test is placed on a wooden table with a height of 0.8m in the EMC lab.

- Test parameters and marginal conditions

The harmonic test is carried out in according the classification A,B,C,D of the standard IEC/EN 61000-3-2. The flicker test is carried out in according the time interval of the standard IEC/EN 61000-3-3. Both tests are carried out with above mentioned equipment with 230V and 50 Hz. (see picture 3) Further information please find in test protocol.

Registration number: W6M20907-9921-E-11

Current Harmonics and Flicker
according to
EN 61000 - 3 - 2,
EN 61000 - 3 - 3

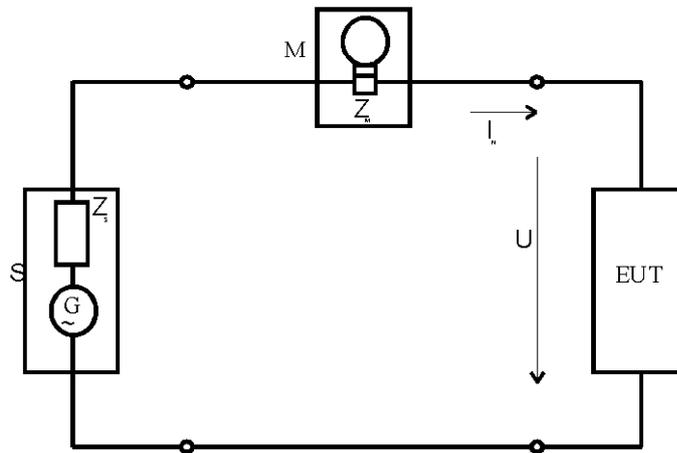

- S supply source
- M measuring equipment
- EUT equipment under test
- U test voltage
- Z_m input impedance of the measuring equipment
- Z_s internal impedance of the supply source
- I_c upper shrinkage portion of the conduction current order
- G open-circuit voltage of the supply source

Picture 3



Electrostatic Discharge

Test Equipment

a) ESD Simulator (ESD2000)

For your reference please find it in our test equipment list at page 4 to 6 as number : ETSTW-EMS 018

b) EMC Immunity Test System (TRA2000IN6)

For your reference please find it in our test equipment list at page 4 to 6 as number : ETSTW-EMS 003

c) Frequency Converter (YF-6020)

For your reference please find it in our test equipment list at page 4 to 6 as number : ETSTW-EMS 002

Test Procedures

- Test configuration

The test configuration is in correspondence to the standard IEC/EN 61000-4-2. The equipment under test is placed on a wooden table with one metal plate on its top and one metal plate under the table, which is grounded. Both plates are connected with two 470 k Ω resistor in series. (see picture 4)

- Test parameters and marginal conditions

The test is carried out with $\pm 2\text{kV}$, $\pm 4\text{kV}$ contact discharge and $\pm 2\text{kV}$, $\pm 4\text{kV}$ and $\pm 8\text{kV}$ air discharge.

Time between two discharges ≥ 1 second

Ten discharges for every point every voltage and polarity

The tested points please find in the test protocol.

Electrostatic Discharge according to EN 61000 - 4 - 2

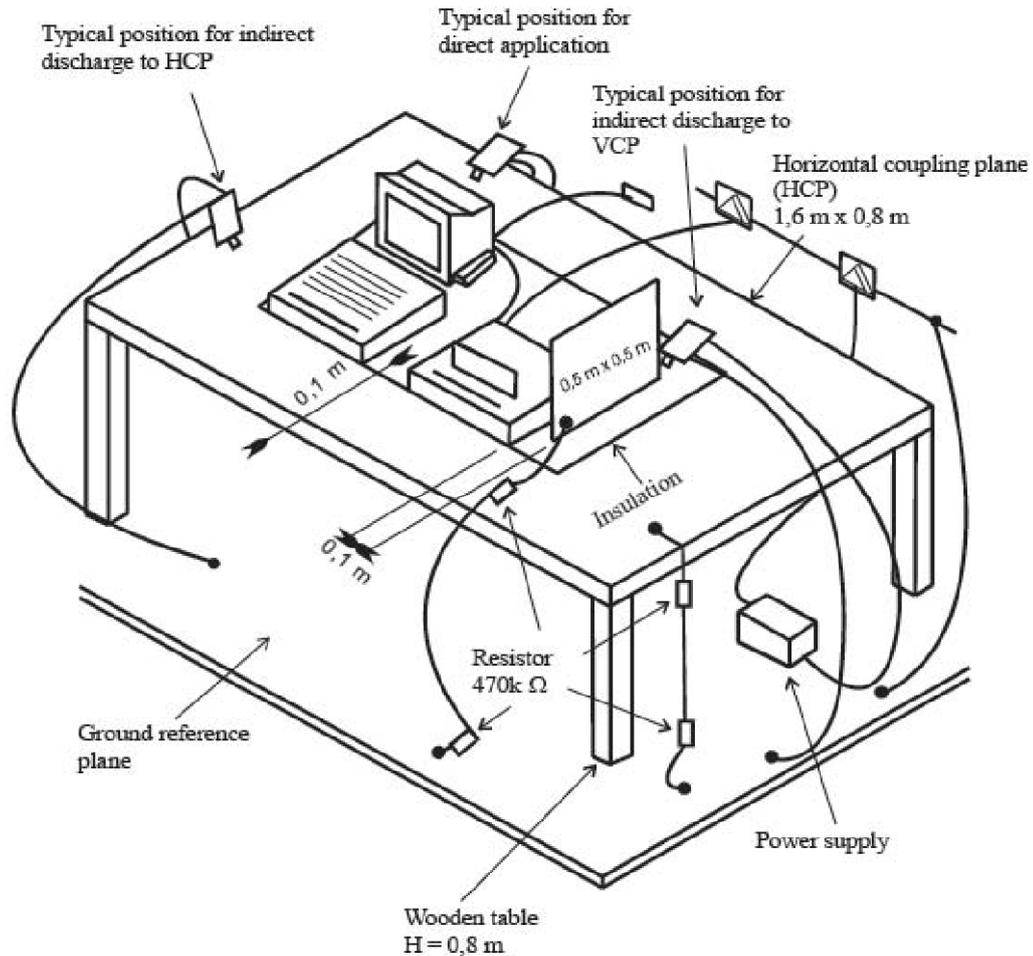

Picture 4

Registration number: W6M20907-9921-E-11



RF Electromagnetic Field (80-1000 MHz)

Test Equipment

- a) Biconical Antenna (3109)
For your reference please find it in our test equipment list at page 4 to 6 as number: ETSTW-RE 029
- b) Log-Periodic Dipole Antenna (HL223)
For your reference please find it in our test equipment list at page 4 to 6 as number: ETSTW-RE 043
- c) MICROWAVE HORN ANTENNA (AT4002A)
For your reference please find it in our test equipment list at page 4 to 6 as number: ETSTW-RE 020
- d) RF Power Amplifier (30S1G3)
For your reference please find it in our test equipment list at page 4 to 6 as number: ETSTW-RS 003
- e) SIGNAL GENERATOR (8648C)
For your reference please find it in our test equipment list at page 4 to 6 as number: ETSTW-RS 009
- f) RF Power Amplifier (150W1000)
For your reference please find it in our test equipment list at page 4 to 6 as number: ETSTW-RS 004
- g) Electric Field Probe Type 8.3 (EMR-20)
For your reference please find it in our test equipment list at page 4 to 6 as number: ETSTW-RS 005
- h) Millivoltmeter (URV 55)
For your reference please find it in our test equipment list at page 4 to 6 as number: ETSTW-RE 032
- i) Power Sensor (URV5-Z4)
For your reference please find it in our test equipment list at page 4 to 6 as number: ETSTW-RE 034

Test Procedures

- **Test configuration**

The test configuration is contained inside of a shielded chamber and corresponds to the standard IEC/EN 61000-4-3. The equipment under test is placed in the facility on a wooden table 0.8m height on the centre axis of the chamber. The power supply and the RF connection points are close to the equipment under test at the floor of the chamber inside a connection box. The cables to this connection box are shielded and below the double floor. The transmitting antenna is placed in a height of 1.5m, in a distance of 3.0m. The RF-generators are placed in a special room adjacent to the chamber. (see picture 5) The observation of the equipment under test is realized by 3 video cameras and by a microphone. In order to establish the severity of the test for EUT an wires which must be tested close to the earth reference plane or which have larger sides than 1.5m x 1.5 m, the intensity of the field is also recorded at 0.4 m height, and for the full width and height of the EUT.

- **Test parameters and marginal conditions**

The tests are carried out with field strength by 3 V/m (measured in the un-modulated field) with amplitude modulated signal by a depth of 80 % by a sinusoidal audio signal of 1 kHz. The logarithmic step was 1% and the dwell time was 1s dependent of the EUT cycle time. Further information please find in test protocol.

RF - Field according to EN 61000 - 4 - 3

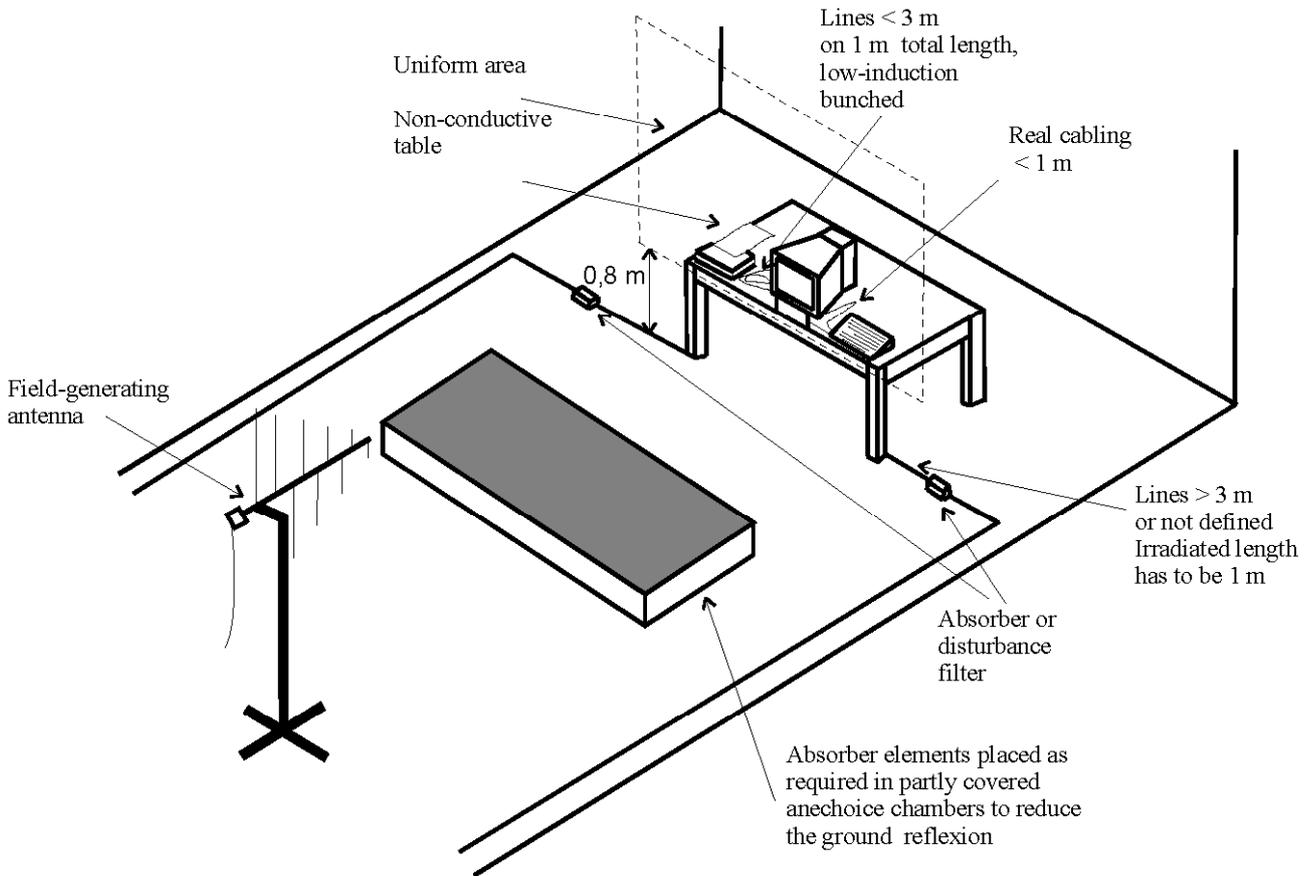

Picture 5



Transients common mode

Test Equipment

a) EMC Immunity Test System (TRA2000IN6)

For your reference please find it in our test equipment list at page 4 to 6 as number : ETSTW-EMS 003

b) Frequency Converter (YF-6020)

For your reference please find it in our test equipment list at page 4 to 6 as number : ETSTW-EMS 002

c) BASELSTRASSE 160 CH-4242 LAUFEN (CN-EFT1000)

For your reference please find it in our test equipment list at page 4 to 6 as number : ETSTW-EMS 001

Test Procedures

- Test configuration

The test configuration is in correspondence to the standard IEC/EN 61000-4-4. The equipment under test is placed on a wooden table with a height of $0.8\text{m} \pm 0.08\text{m}$. The table stands on metal plate which is grounded. (see picture 6)

- Test parameters and marginal conditions

The tests are carried out with 0.5 kV open circuit voltage on signal, control ports and DC power ports and with 1 kV open circuit voltage on AC mains power input. The applied voltage please find in the test protocol.

Electrical Fast Transients according to EN 61000 - 4 - 4

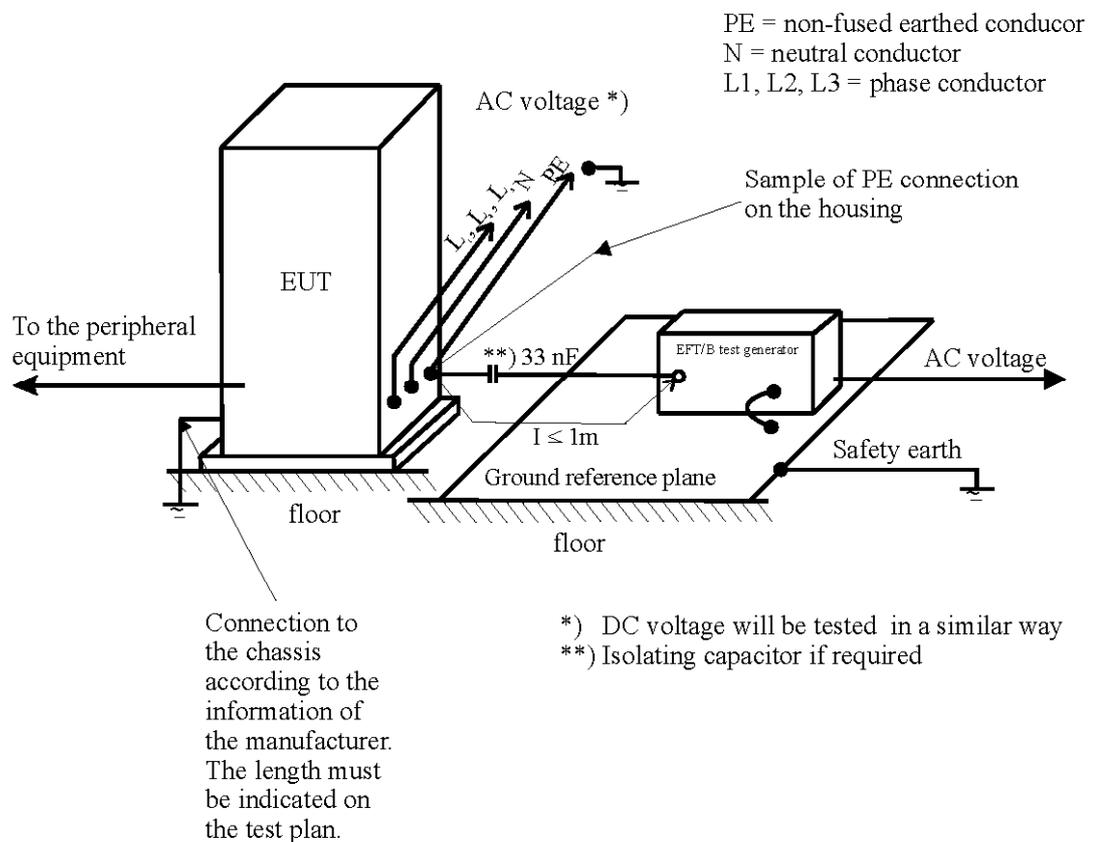

Picture 6



Transients surge common and differential mode

Test Equipment

a) EMC Immunity Test System (TRA2000IN6)

For your reference please find it in our test equipment list at page 4 to 6 as number : ETSTW-EMS 003

b) Frequency Converter (YF-6020)

For your reference please find it in our test equipment list at page 4 to 6 as number : ETSTW-EMS 002

Test Procedures

- Test configuration

The test configuration is in correspondence to the standard IEC/EN 61000-4-5. The equipment under test is placed on a wooden table with a height of 0.8m. The table stands on metal plate which is grounded.

- Test parameters and marginal conditions

The tests are carried out with 0.5, 1, 2 kV open circuit voltage for common mode and with 0.5, 1 kV open circuit voltage for differential mode. (see picture 7) Further information please find in the test protocol.

Transients common & differential mode
according to
EN 61000 - 4 - 5

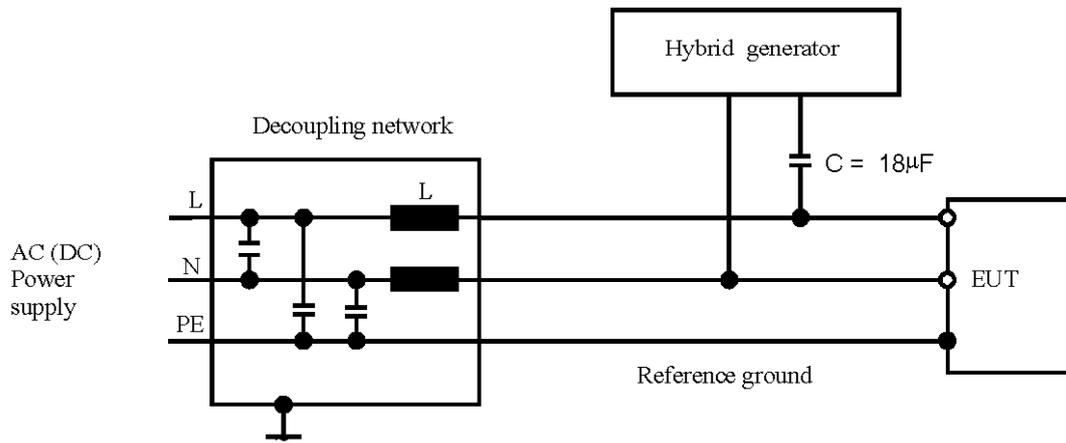

Picture 7



Radio frequency common mode

Test Equipment

- a) SIGNAL GENERATOR (8648C)
For your reference please find it in our test equipment list at page 4 to 6 as number : ETSTW-RS 009
- b) RF Power Amplifier (100A250A)
For your reference please find it in our test equipment list at page 4 to 6 as number : ETSTW-CS 005
- c) COUPLING AND DECOUPLING NETWORK (CDN T400, CDN M016)
For your reference please find it in our test equipment list at page 4 to 6 as number : ETSTW-CS 003 ,
ETSTW-CS 004
- d) Power Sensor (URV5-Z4)
For your reference please find it in our test equipment list at page 4 to 6 as number : ETSTW-RE 034
- e) Millivoltmeter (URV 55)
For your reference please find it in our test equipment list at page 4 to 6 as number : ETSTW-RE 032
- f) 6 dB Attenuator (HFP-5100-3/06 N M/F)
For your reference please find it in our test equipment list at page 4 to 6 as number : ETSTW-CS 008
- g) Frequency Converter (YF-6020)
For your reference please find it in our test equipment list at page 4 to 6 as number : ETSTW-EMS 002

Test Procedures

- Test configuration

The test configuration is in correspondence to the standard IEC/EN 61000-4-6. The test was carried out on a wooden table with a grounded metal plate on its top. The equipment under test was placed on an insulating support of 0.1m height above this metal plate ,and all cables exiting the EUT was supported at a height of between 30mm and 50mm. Where coupling and/or decoupling devices are required, they was located between 0.1m and 0.3m from the EUT. (see picture 8)

- Test parameters and marginal conditions

The tests were carried out with a Voltage of 3V RMS (measured unmodulated) with amplitude modulated signal by a depth of 80 % by a sinusoidal signal of 1 kHz. The frequency steps in the frequency range 150 kHz - 80 MHz increments with 1 % of the preceding frequency value. The dwell time was in case no less than 0.5s dependent on the EUT operating time. The tested ports please find in the test protocol.

**RF- continues conducted according to
EN 61000 - 4 - 6**

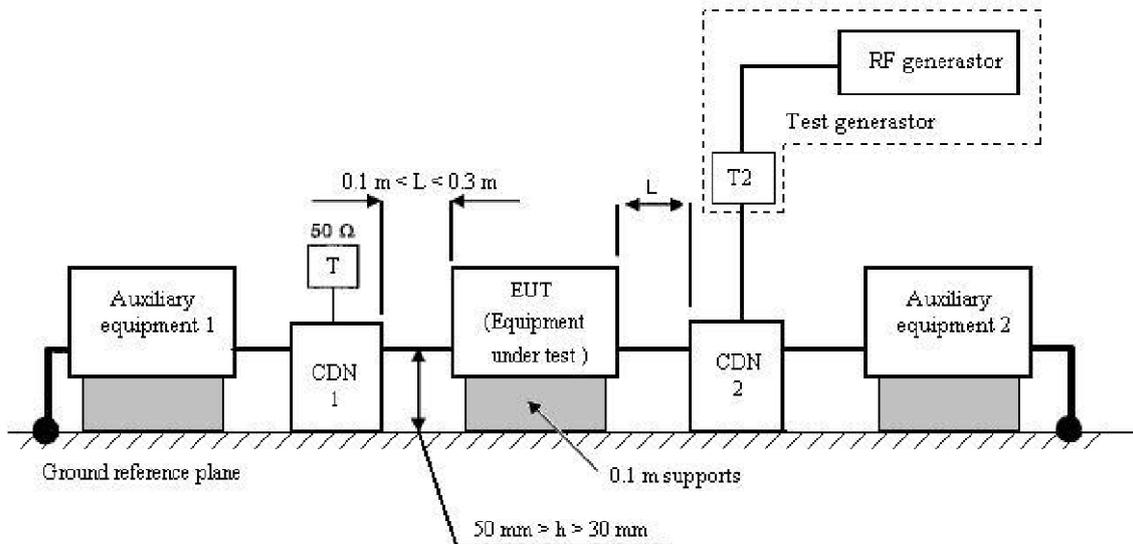

T : Termination 50 Ω
 T2: Power attenuator (6 dB)
 CDN: Coupling and decoupling network

Picture 8



Voltage dips and interruptions

Test Equipment

a) EMC Immunity Test System (TRA2000IN6)

For your reference please find it in our test equipment list at page 4 to 6 as number : ETSTW-EMS 003

b) Frequency Converter (YF-6020)

For your reference please find it in our test equipment list at page 4 to 6 as number : ETSTW-EMS 002

Test Procedures

- Test configuration

The test configuration is in correspondence to the standard IEC/EN 61000-4-11. The equipment under test is placed on a wooden table with a height of 0.8 metre. (see picture 9)

- Test parameters and marginal conditions

The test levels corresponding to a reduction of the supply voltage of 30 % (for 500ms) > 95 % (for 10ms) and interruption > 95 % (5s). The applied voltage please find in the test protocol.

Voltage dips and interruption according to EN 61000 - 4 - 11

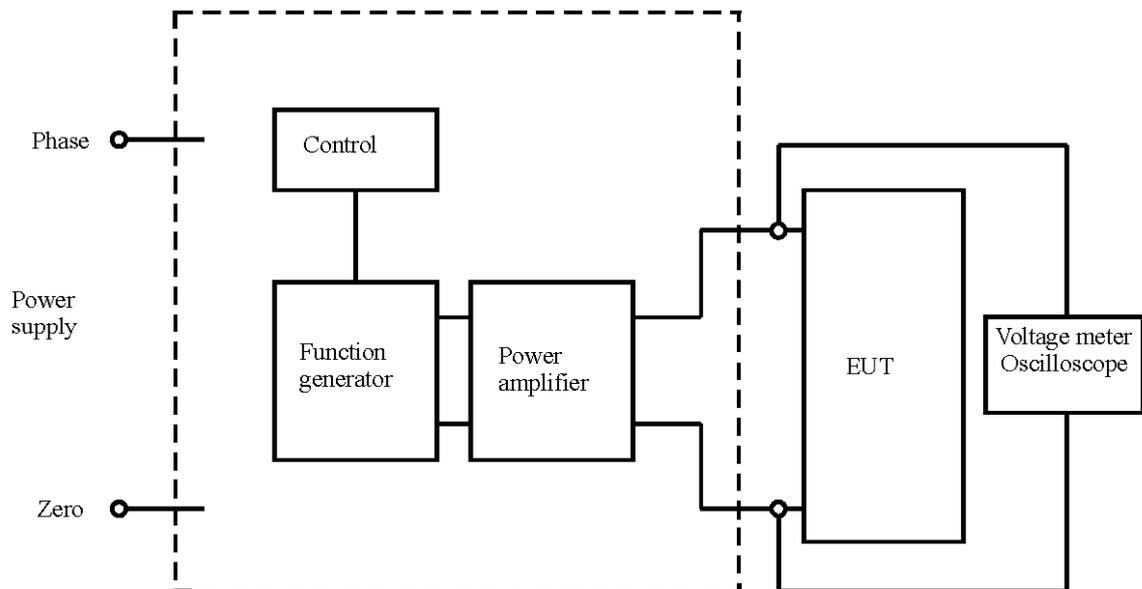

Picture 9



Radio Noise Field Strength

Emission

Model: DH5100B1AP1T2B Date: 2009/7/17
 Mode: Temperature: 24 °C Engineer: Leon
 Polarization: Horizontal Humidity: 52 %

Frequency (MHz)	Reading (dBuV)	Detector	Factor (dB)	Result (dBuV/m)	Limit (dBuV/m)	Margin (dB)	Table Degree (Deg.)	Ant. High (cm)
69.499	6.55	peak	12.24	18.79	30.00	-11.21	150	330
118.738	3.34	peak	13.29	16.63	30.00	-13.37	240	350
244.810	9.83	peak	13.69	23.52	37.00	-13.48	300	310
424.850	9.24	peak	18.33	27.57	37.00	-9.43	300	110
567.936	11.81	peak	21.25	33.06	37.00	-3.94	280	150
595.992	7.36	peak	22.06	29.42	37.00	-7.58	230	120

Frequency (MHz)	Reading (dBuV)		Factor (dB) Corr.	Result @3m (dBuV/m)		Limit @3m (dBuV/m)		Margin (dB)	Table Degree (Deg.)	Ant. High (cm)
	Peak	Ave.		Peak	Ave.	Peak	Ave.			
1302.605	52.56	---	-22.10	30.46	---	70.00	50.00	-39.54	260	110
1781.563	54.27	---	-20.29	33.98	---	70.00	50.00	-36.02	120	140

Polarization: Vertical

Frequency (MHz)	Reading (dBuV)	Detector	Factor (dB)	Result (dBuV/m)	Limit (dBuV/m)	Margin (dB)	Table Degree (Deg.)	Ant. High (cm)
67.876	10.79	peak	12.66	23.45	30.00	-6.55	350	120
115.491	15.49	peak	12.94	28.43	30.00	-1.57	160	100
212.886	11.60	peak	12.39	23.99	30.00	-6.01	210	150
438.878	4.14	peak	18.71	22.85	37.00	-14.15	80	300
567.936	8.07	peak	21.25	29.32	37.00	-7.68	190	340
957.916	-1.35	peak	27.24	25.89	37.00	-11.11	250	310

Registration number: W6M20907-9921-E-11



Worldwide Testing Services(Taiwan) Co., Ltd.

Frequency (MHz)	Reading (dBuV)		Factor (dB) Corr.	Result @3m (dBuV/m)		Limit @3m (dBuV/m)		Margin (dB)	Table Degree (Deg.)	Ant. High (cm)
	Peak	Ave.		Peak	Ave.	Peak	Ave.			
1318.637	52.51	---	-22.12	30.39	---	70.00	50.00	-39.61	140	350
1771.543	53.66	---	-20.32	33.34	---	70.00	50.00	-36.66	200	320

- Note**
- 1. Correction Factor = Antenna factor + Cable loss - Preamplifier**
 - 2. The formula of measured value as: Test Result = Reading + Correction Factor**
 - 3. Detector function in the form : PK = Peak, QP = Qusai Peak, AV = Average**
 - 4. All not in the table noted test results are more than 20 dB below the relevant limits.**
 - 5. Measurement uncertainty 30-200MHz = ±5.16dB, 200-1000 MHz = ± 5.30dB, 1-6 GHz = ± 5.64 dB ; Reported uncertainties represent expanded uncertainties expressed at approximately the 95% confidence level using a coverage factor of k = 2.**
 - 6. See the attached diagram as appendix.**

Registration number: W6M20907-9921-E-11



Conducted Emission

Emission

Model: DH5100B1AP1T2B Date: 2009/7/30
 Mode: Temperature: 24 °C Engineer: Boan
 Polarization: N Humidity: 51 %

Frequency (MHz)	Reading (dBuV)		Factor (dB) Corr.	Result (dBuV)		Limit (dBuV)		Margin (dB)
	QP	Ave.		QP	Ave.	QP	Ave.	
0.1600	39.56	35.66	10.17	49.73	45.83	65.46	55.46	-9.63
0.3973	36.67	32.84	10.04	46.71	42.88	57.91	47.91	-5.03
0.4491	34.06	29.85	10.17	44.23	40.02	56.89	46.89	-6.87
0.5450	31.56	29.19	10.16	41.72	39.35	56.00	46.00	-6.65
3.3725	38.90	32.74	10.10	49.00	42.84	56.00	46.00	-3.16
24.0000	16.02	11.71	10.58	26.60	22.29	60.00	50.00	-27.71

Polarization: L1

Frequency (MHz)	Reading (dBuV)		Factor (dB) Corr.	Result (dBuV)		Limit (dBuV)		Margin (dB)
	QP	Ave.		QP	Ave.	QP	Ave.	
0.1585	40.12	38.32	10.25	50.37	48.57	65.54	55.54	-6.97
0.3977	36.78	32.66	10.13	46.91	42.79	57.90	47.90	-5.11
0.4459	35.98	31.58	10.25	46.23	41.83	56.95	46.95	-5.12
0.8900	31.51	24.41	10.22	41.73	34.63	56.00	46.00	-11.37
3.3700	37.14	30.36	10.28	47.42	40.64	56.00	46.00	-5.36
23.7777	7.77	1.03	11.71	19.48	12.74	60.00	50.00	-37.26

- Note**
1. The formula of measured value as: $\text{Test Result} = \text{Reading} + \text{Correction Factor}$
 2. The Correction Factor = Cable Loss + LISN Insertion Loss + Pulse Limit Loss
 3. Detector function in the form : PK = Peak, QP = Quasi Peak, AV = Average
 4. All not in the table noted test results are more than 20 dB below the relevant limits.
 5. Measurement uncertainty = $\pm 1.77\text{dB}$; Reported uncertainties represent expanded uncertainties expressed at approximately the 95% confidence level using a coverage factor of $k = 2$.
 6. See attached diagram as appendix.



Electrostatic Discharge

ESD

Standard : IEC/EN 61000 - 4 - 2

Device : DH5100B1AP1T2B

Date : July 23, 2009

Temperature : 24.8 °C
Pressure : 990 hPa
Rel. humidity: 50 %

Test point	Table (T) Floor (F)	Contact (C) Air (A)	Voltage (kV)	Polarity (+ / -)	Performance criteria
Housing	T	A	2, 4, 8	+ / -	A
Housing	T	C	2, 4	+ / -	B
Indirect	T	C	2, 4	+ / -	A

Registration number: W6M20907-9921-E-11

ESD discharge points

The top of EUT

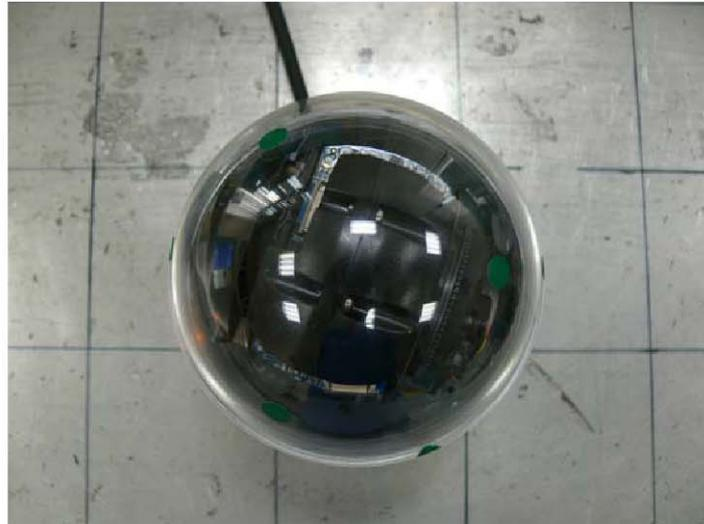

The back of EUT



The left of EUT

Registration number: W6M20907-9921-E-11



Worldwide Testing Services(Taiwan) Co., Ltd.



The right of EUT



Performance criteria :

Registration number: W6M20907-9921-E-11



Worldwide Testing Services(Taiwan) Co., Ltd.

- A: Normal performance within the specification.
- B: Temporary degradation or less of function or performance which is self recoverable
- C: Temporary degradation or loss of function or perform. which requires. operate intervention or system reset
- D: Degradation or loss of function which is not recoverable due to damage of equipment (components) or software, or loss of data.

NA: Not Applicable

Explanation: ./.

Registration number: W6M20907-9921-E-11



Interference Immunity Against Electromagnetic Irradiation

RF Field

Standard : IEC/EN 61000 – 4 – 3

Device : DH5100B1AP1T2B

Date : July 23, 2009

Temperature : 23.9 °C
Pressure : 921 hPa
Rel. humidity: 52 %

Test equipment : Anechoic Chamber, Generator SMG (R&S), Monitoring System, Amplifier 10W1000/150L (ar), Antenna SAS-200/521 (AHS)

Severity Level : 2 (3V/m)

Modulation Frequency : 1kHz (80%AM)

Pulsmodulation : 1 Hz (0.5s on;0.5s off)

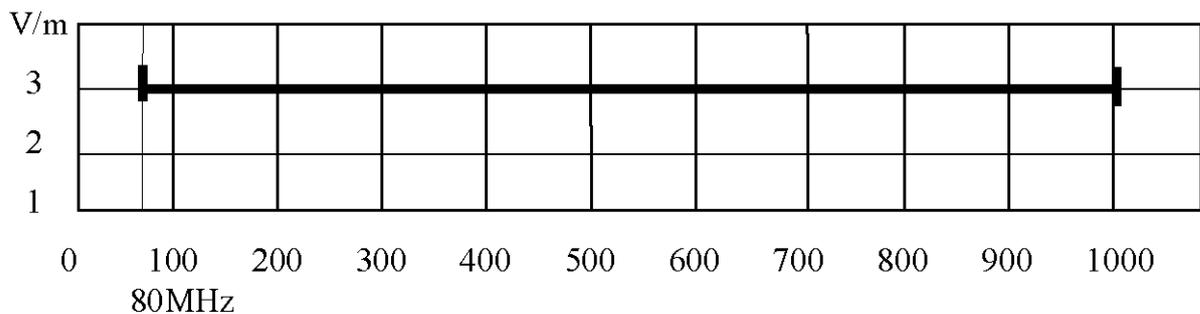

Performance criteria :

- A : No loss of performance or function
- B : Temporary loss of function or performance which is self recoverable
- C : Temporary loss of function or perform. which req. operator intervention or system reset
- D : Loss of function which is not recoverable

Registration number: W6M20907-9921-E-11



Electrical Fast Transients

Burst

Standard : IEC/EN 61000 – 4 – 4

Device : DH5100B1AP1T2B

Date : July 23, 2009

Temperature : 23.9 °C
Pressure : 921 hPa
Rel. humidity: 52 %

Testport	Voltage (kV)	Polarity (+ / -)	Waveform T _r / T _h	Repetition Frequency (kHz)	Performance criteria
AC-Power line	1	+ / -	5/50 ns	5	B

Performance criteria :

- A : No loss of performance or function
- B : Temporary loss of function or performance which is self recoverable
- C : Temporary loss of function or perform. which req. operate. intervention or system reset
- D : Loss of function which is not recoverable



Transients common & diff. mode

Surge

Standard : IEC/EN 61000 - 4 - 5

Device : DH5100B1AP1T2B

Date : July 23, 2009

Temperature : 23.9 °C
Pressure : 921 hPa
Rel. humidity: 52 %

Test mode	Voltage (kV)	Waveform T_r / T_h	Performance criteria
AC-line to line	1	1.2/50 μ s	A
AC- line to ground	2	1.2/50 μ s	A

Performance criteria :

- A : No loss of performance or function
- B : Temporary loss of function or performance which is self recoverable
- C : Temporary loss of function or perform. which req. operate. intervention or system reset
- D : Loss of function which is not recoverable

Registration number: W6M20907-9921-E-11



continues conducted

RF - common mode

Standard : IEC/EN 61000 - 4 - 6

Device : DH5100B1AP1T2B

Date : July 23, 2009

Temperature : 23.9 °C
Pressure : 921 hPa
Rel. humidity: 52 %

Test port	Voltage (Vrms)	Modulation Frequency	Frequency Range	Performance criteria
AC-Power line	3	1 kHz	150 kHz - 80 MHz	A

Performance criteria :

- A : No loss of performance or function
- B : Temporary loss of function or performance which is self recoverable
- C : Temporary loss of function or perform. which req. operate. intervention or system reset
- D : Loss of function which is not recoverable

Registration number: W6M20907-9921-E-11



Voltage dips and interruption

V - Dips

Standard : IEC/EN 61000 - 4 - 11

Device : DH5100B1AP1T2B

Date : July 23, 2009

Temperature : 23.9 °C
Pressure : 921 hPa
Rel. humidity: 52 %

Reduction of supply voltage of	Voltage in % (in V)	Duration in ms	Performance criteria
Interruption (> 95 %)	0% (0 V)	250 (5 s)	B
Dips (>95 %)	5% (12 V)	0.5 (10ms)	A
Dips (30 %)	70% (161 V)	25 (500 ms)	A

Performance criteria :

- A : No loss of performance or function
- B : Temporary loss of function or performance which is self recoverable
- C : Temporary loss of function or perform. which req. operate. intervention or system reset
- D : Loss of function which is not recoverable

Registration number: W6M20907-9921-E-11



Current Harmonics

Harmonics

Standard : IEC/EN 61000 - 3 - 2

Device : DH5100B1AP1T2B

Date : July 23, 2009

Class : A

Temperature : 23.9 °C
Pressure : 921 hPa
Rel. humidity: 52 %

Operator : Boan
Unit : Mini Speed Dome Camera
Serialnumber : DH5100B1AP1T2B
Remarks :

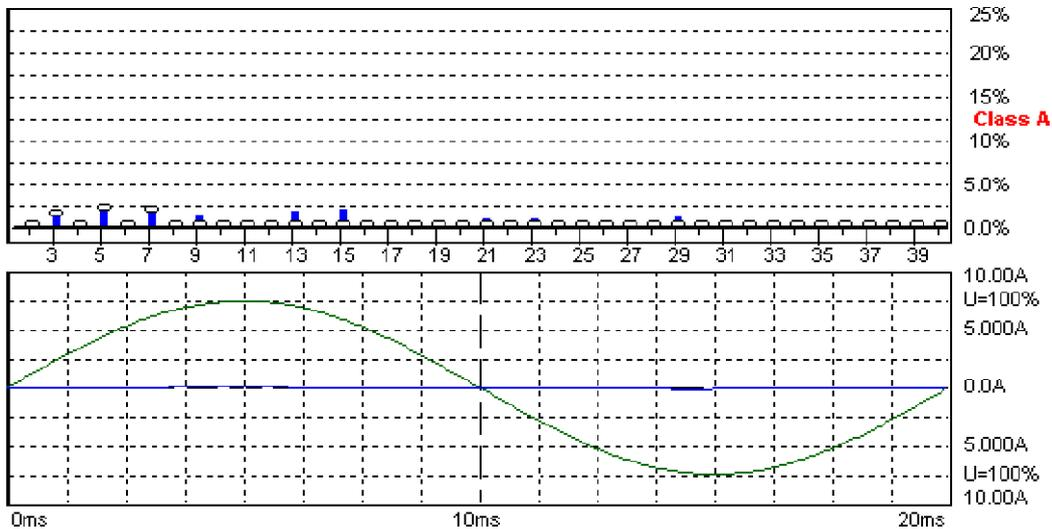

Harmonic Emission - IEC 61000-3-2, EN 61000-3-2, (EN60555-2)

7/23/2009 9:54:53 AM

Urms = 229.7 V P = 8.835 W THC = 0.040 A Range: 10 A
Irms = 0.063 A pf = 0.606 V-nom: 230 V
TestTime: 5 min (100%)

Mini Speed Dome Camera

Test completed, Result: PASSED

Registration number: W6M20907-9921-E-11



Voltage Fluctuation

Flicker

Standard : IEC/EN 61000 - 3 - 3

Device : DH5100B1AP1T2B

Date : July 23, 2009

Temperature : 23.9 °C
Pressure : 921 hPa
Rel. humidity: 52 %

Operator : Boan
Unit : Mini Speed Dome Camera
Serialnumber : DH5100B1AP1T2B
Remarks

Flickermeter 1000-4-15 for 230V/50Hz

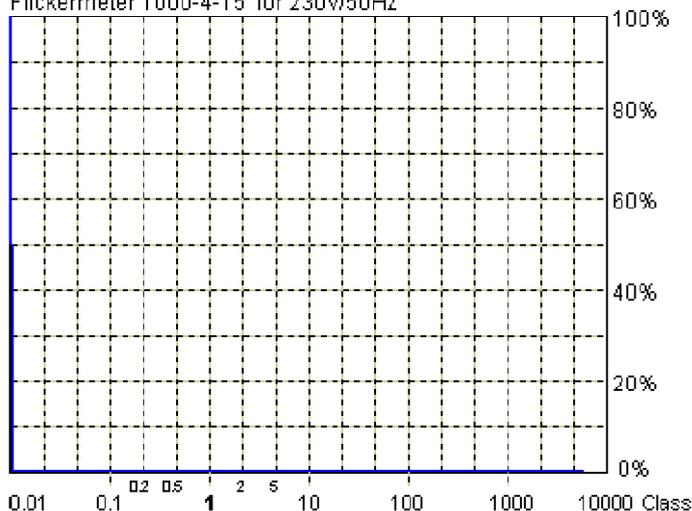

Actual Flicker (Fl): 0.00
Short-term Flicker (Pst): 0.07
Limit (Pst): 1.00
Long-term Flicker (Plt): 0.06
Limit (Plt): 0.65
Maximum Relative Volt. Change (dmax): 0.00%
Limit (dmax): 4.00%
Relative Steady-state Voltage Change (dc): 0.10%
Limit (dc): 3.30%
Maximum Interval exceeding 3.30% (dt): 0.00ms
Limit (dt>Lim): 500ms

Flicker Emission - IEC 61000-3-3 , EN 61000-3-3 , (EN60555-3)

7/23/2009 10:09:20 A

Urms = 229.9 V P = 9.817 W
Irms = 0.073 A pf = 0.583

Range: 50 A
V-nom: 230 V
TestTime: 120 min (866%)

Mini Speed Dome Camera

Test aborted, Result: PASSED

Registration number: W6M20907-9921-E-11



Appendix

A Measurement diagrams

1. Radiated Emission
2. Conducted Emission

B Photos

1. External Photos
2. Internal Photos
3. Set Up Photo of Radiated Emission
4. Set Up Photo of Conducted Emission
5. Set Up Photo of Current Harmonics& Voltage Fluctuations
6. Set Up Photo of ESD
7. Set Up Photo of RF-Field
8. Set Up Photo of EFT
9. Set Up Photo of Surge & V-DIPS
10. Set Up Photo of CS



Radiated Emission Antenna Polarization H

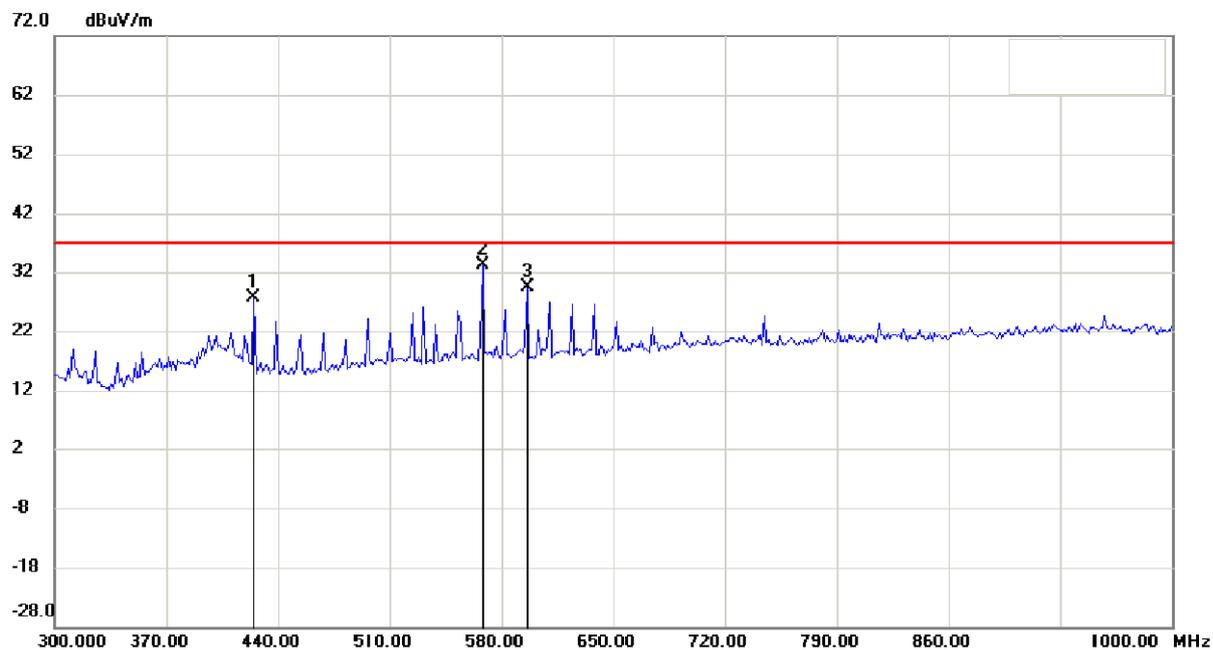
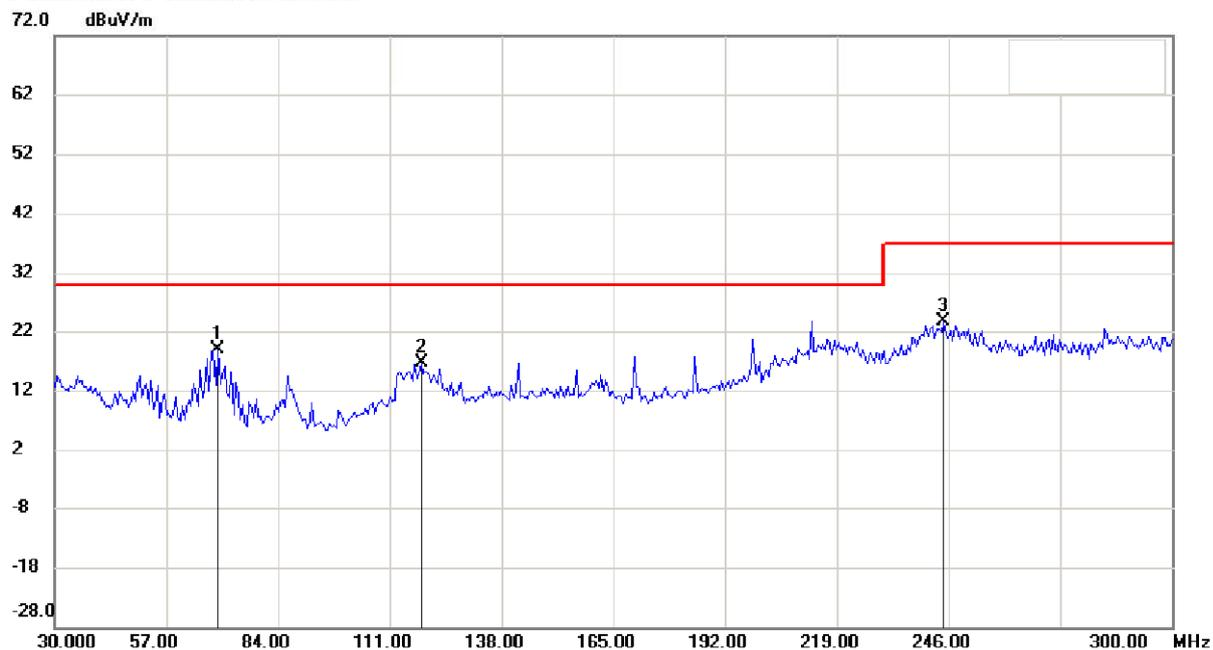

Up Line: Peak Limit Line Down Line: Ave Limit Line

Note:

1. The attached measurement plots are preliminarily pre-scanned with peak detector for determining the final checking frequencies and are for reference only.
2. The some frequencies may exceed the limit line without the specified detectors, but that cannot present the results are failed to the specification of test standard.
3. For corrected test results are listed in the relevant table of radiated test data of this test report.

Registration number: W6M20907-9921-E-11

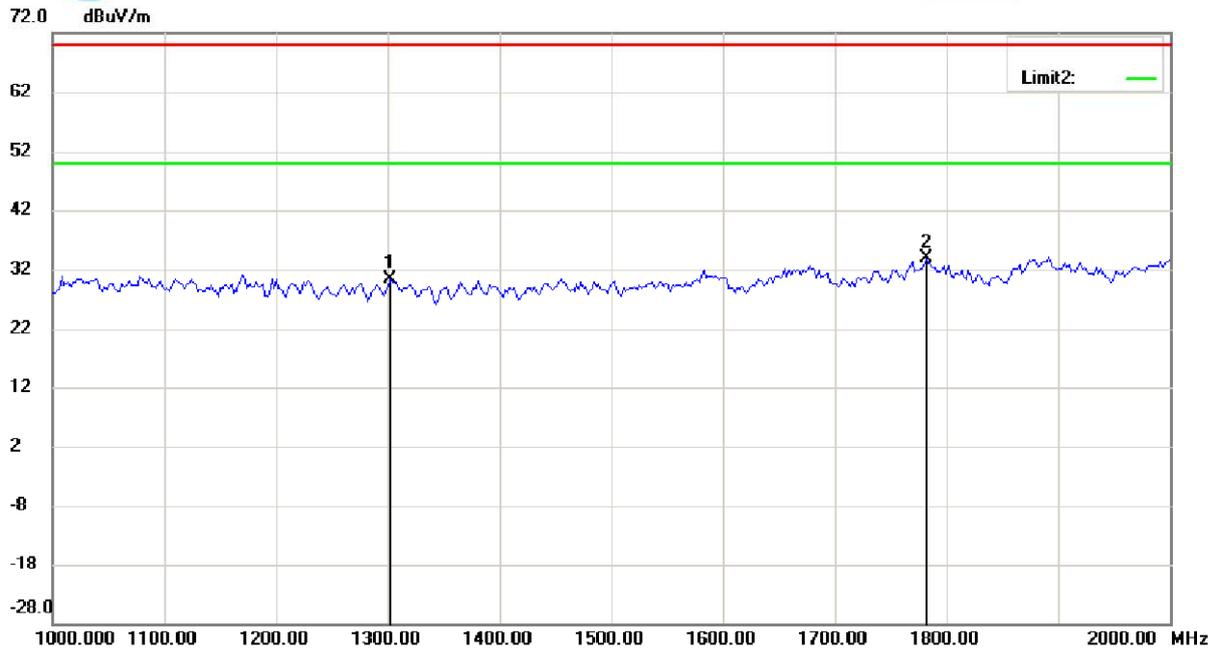
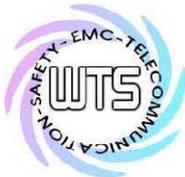

Antenna Polarization V



Up Line: Peak Limit Line Down Line: Ave Limit Line

Note:

1. The attached measurement plots are preliminarily pre-scanned with peak detector for determining the final checking frequencies and are for reference only.
2. The some frequencies may exceed the limit line without the specified detectors, but that cannot present the results are failed to the specification of test standard.
3. For corrected test results are listed in the relevant table of radiated test data of this test report.

Registration number: W6M20907-9921-E-11



Worldwide Testing Services(Taiwan) Co., Ltd.

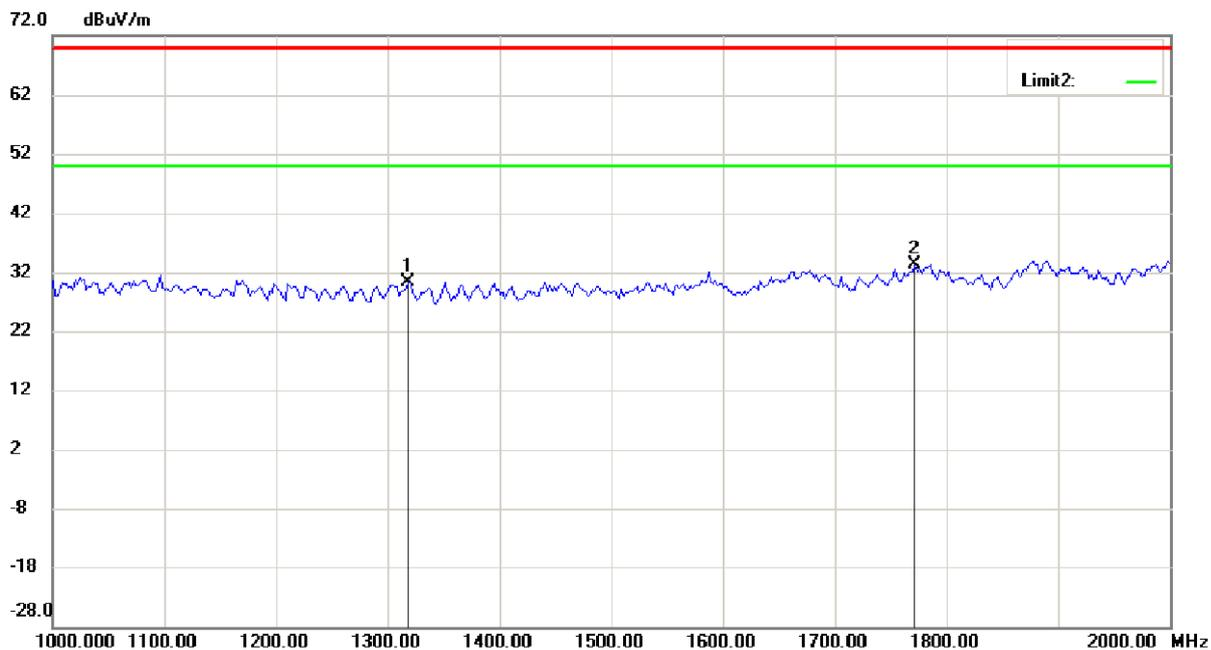
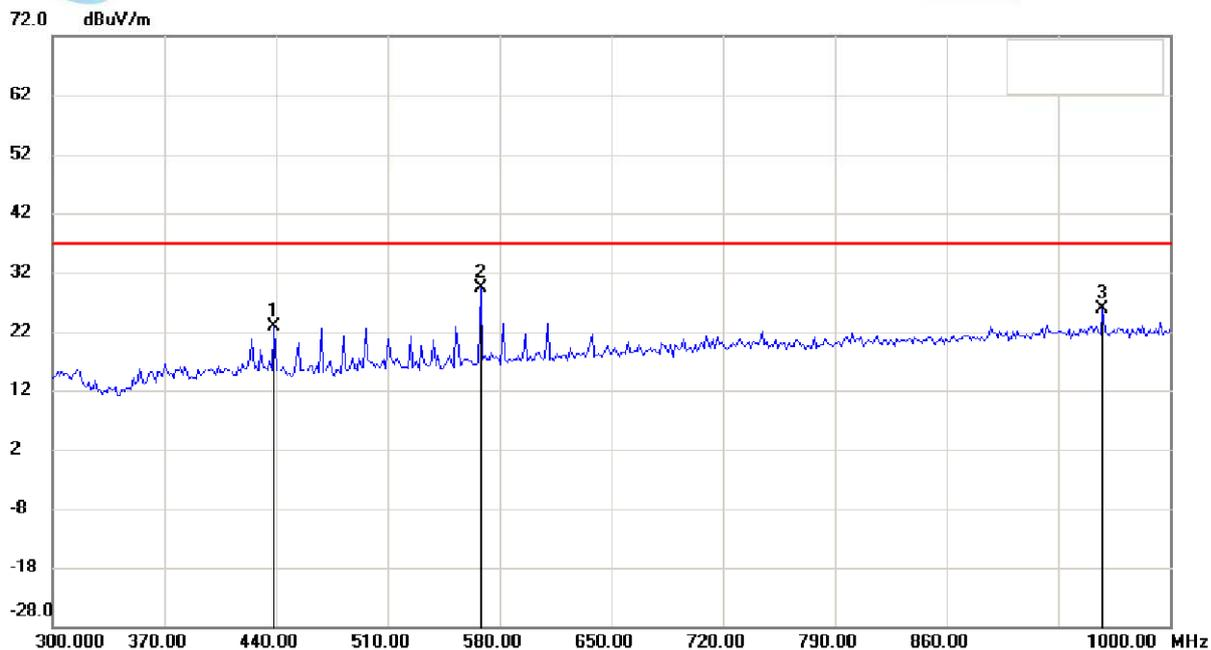

Up Line: Peak Limit Line Down Line: Ave Limit Line

Note:

1. The attached measurement plots are preliminarily pre-scanned with peak detector for determining the final checking frequencies and are for reference only.
2. The some frequencies may exceed the limit line without the specified detectors, but that cannot present the results are failed to the specification of test standard.
3. For corrected test results are listed in the relevant table of radiated test data of this test report.

Registration number: W6M20907-9921-E-11



Conducted Emission

LISN N

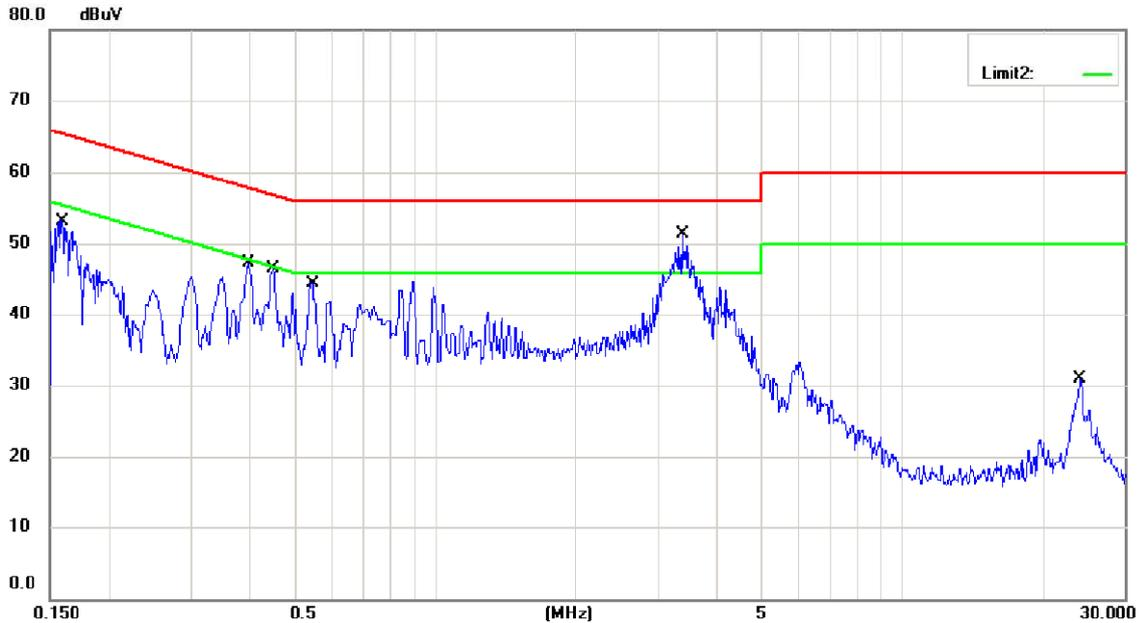

LISN L1



Up Line: QP Limit Line

Down Line: Ave Limit Line

Note:

1. The attached measurement plots are preliminarily pre-scanned with peak detector for determining the final checking frequencies and are for reference only.
2. The some frequencies may exceed the limit line without the specified detectors, but that cannot present the results are failed to the specification of test standard.
3. For corrected test results are listed in the relevant table of AC conducted test data of this test report.

Registration number: W6M20907-9921-E-11



External Photos



Registration number: W6M20907-9921-E-11



Worldwide Testing Services(Taiwan) Co., Ltd.

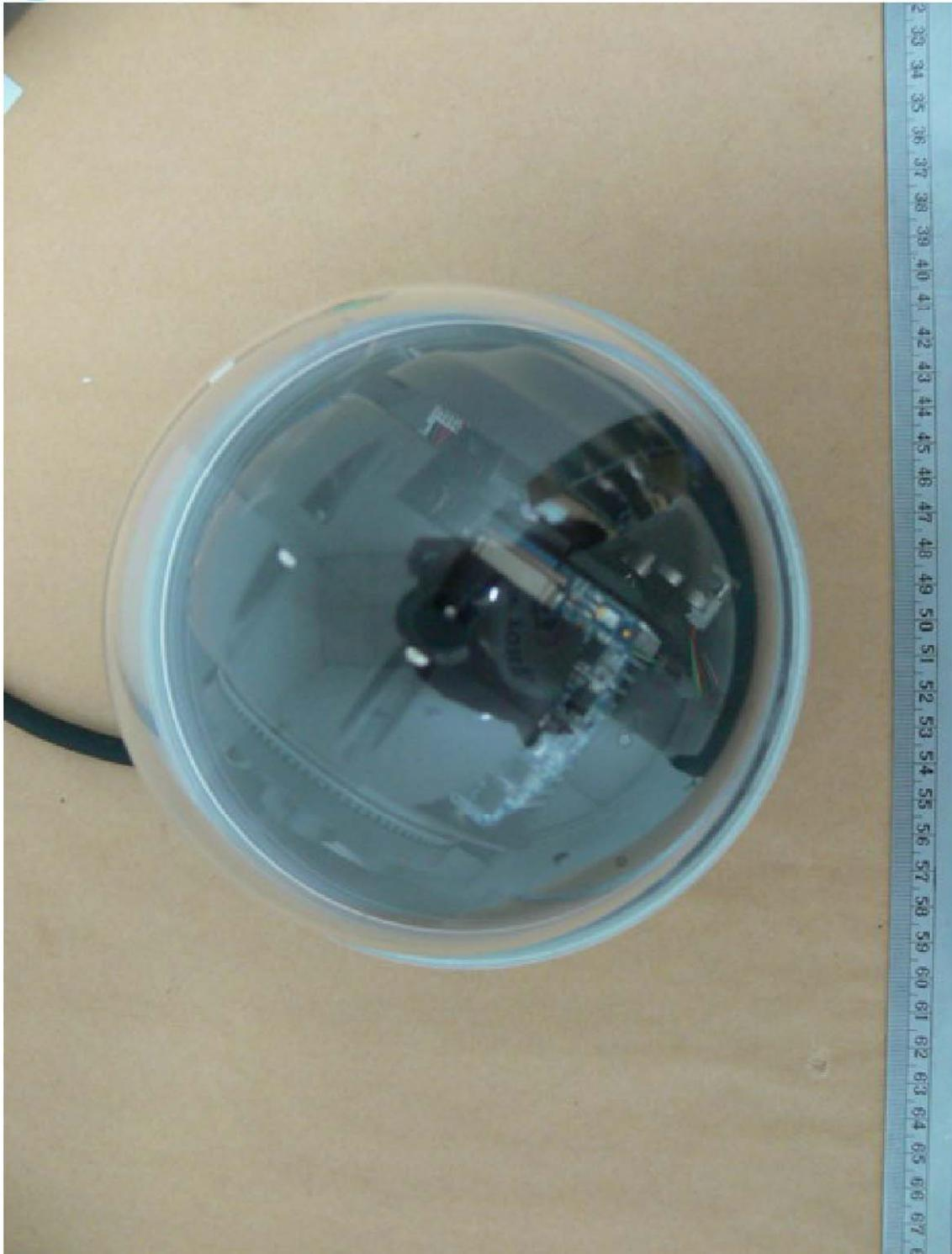

Registration number: W6M20907-9921-E-11



Worldwide Testing Services(Taiwan) Co., Ltd.

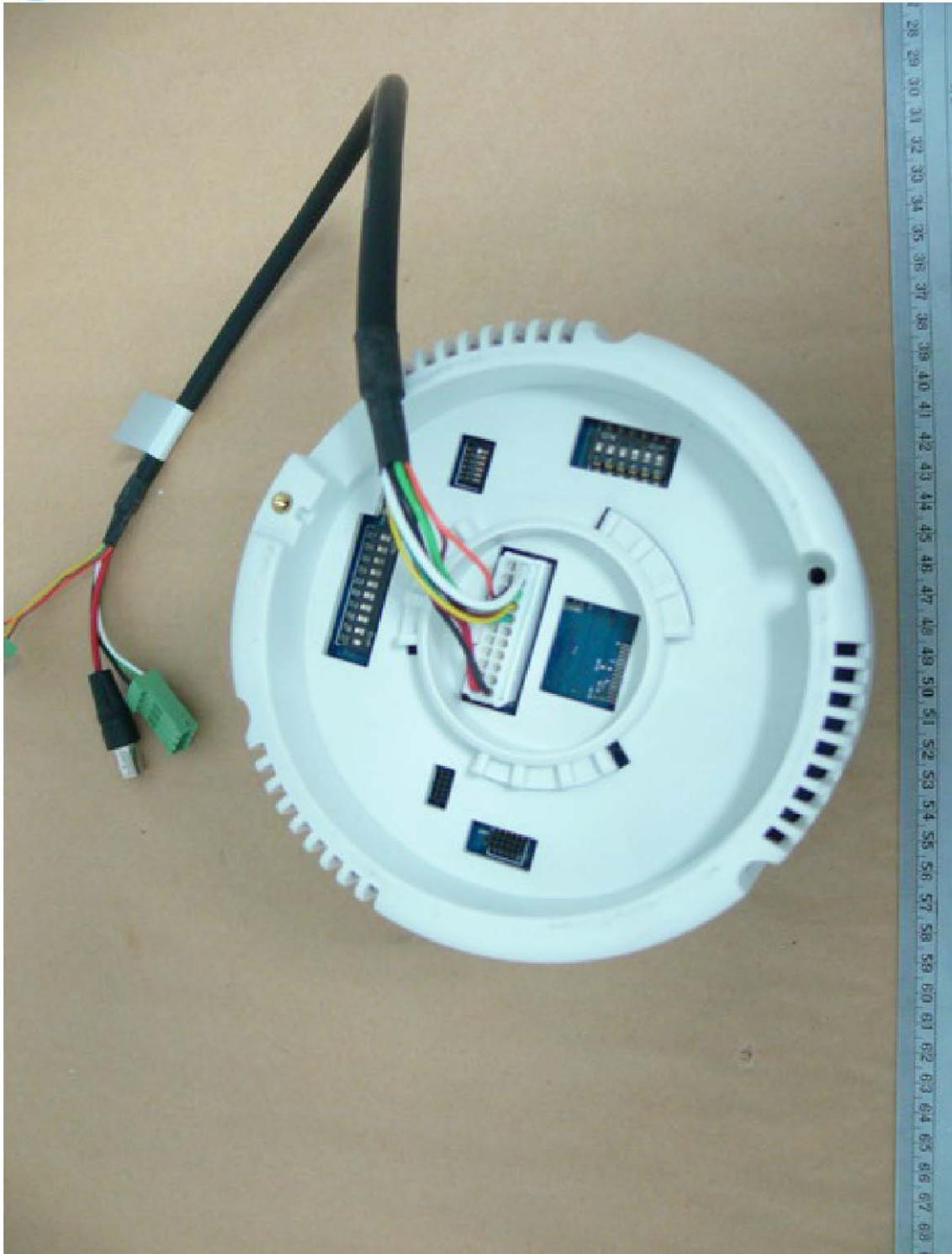

Registration number: W6M20907-9921-E-11

Internal Photos

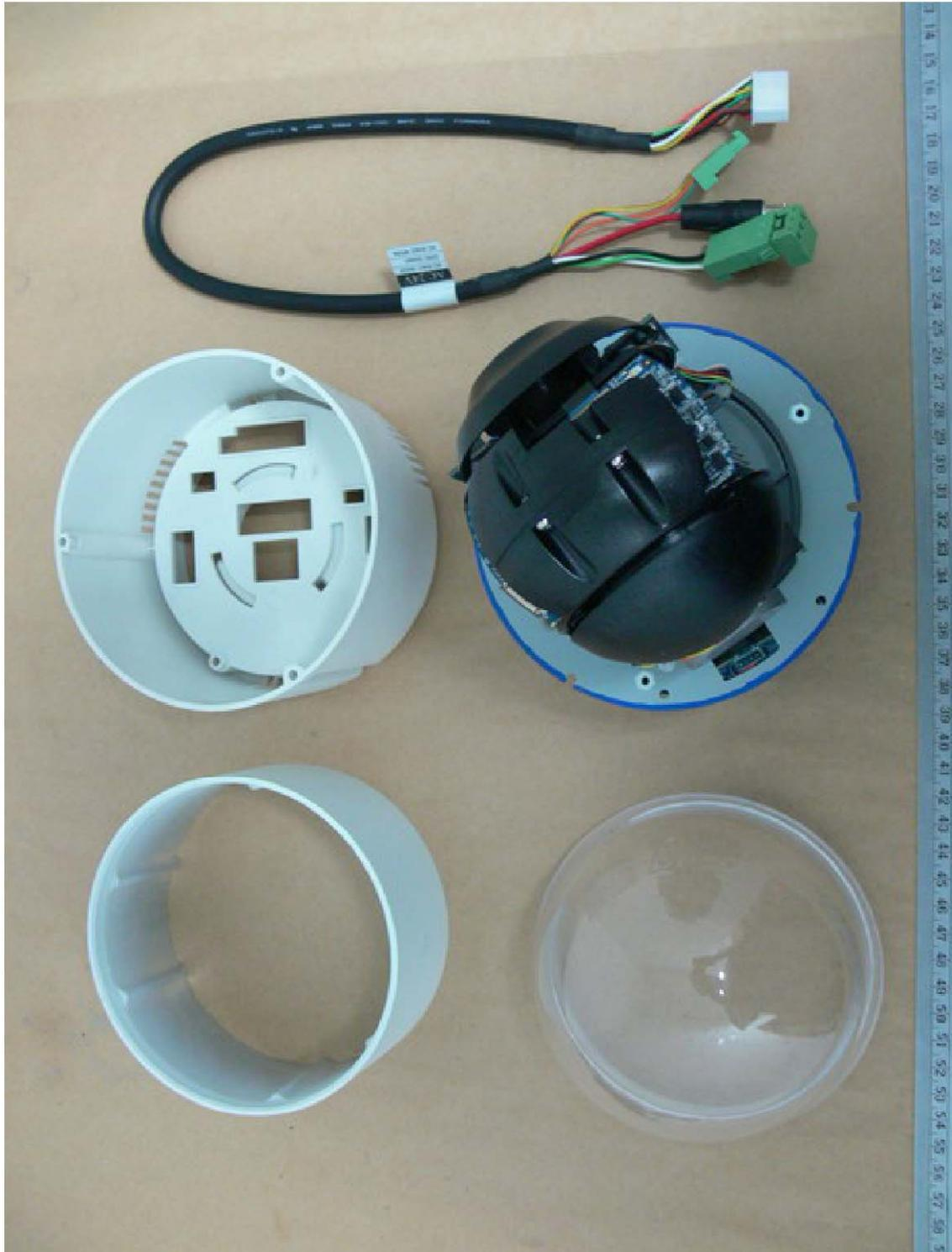

Registration number: W6M20907-9921-E-11



Worldwide Testing Services(Taiwan) Co., Ltd.

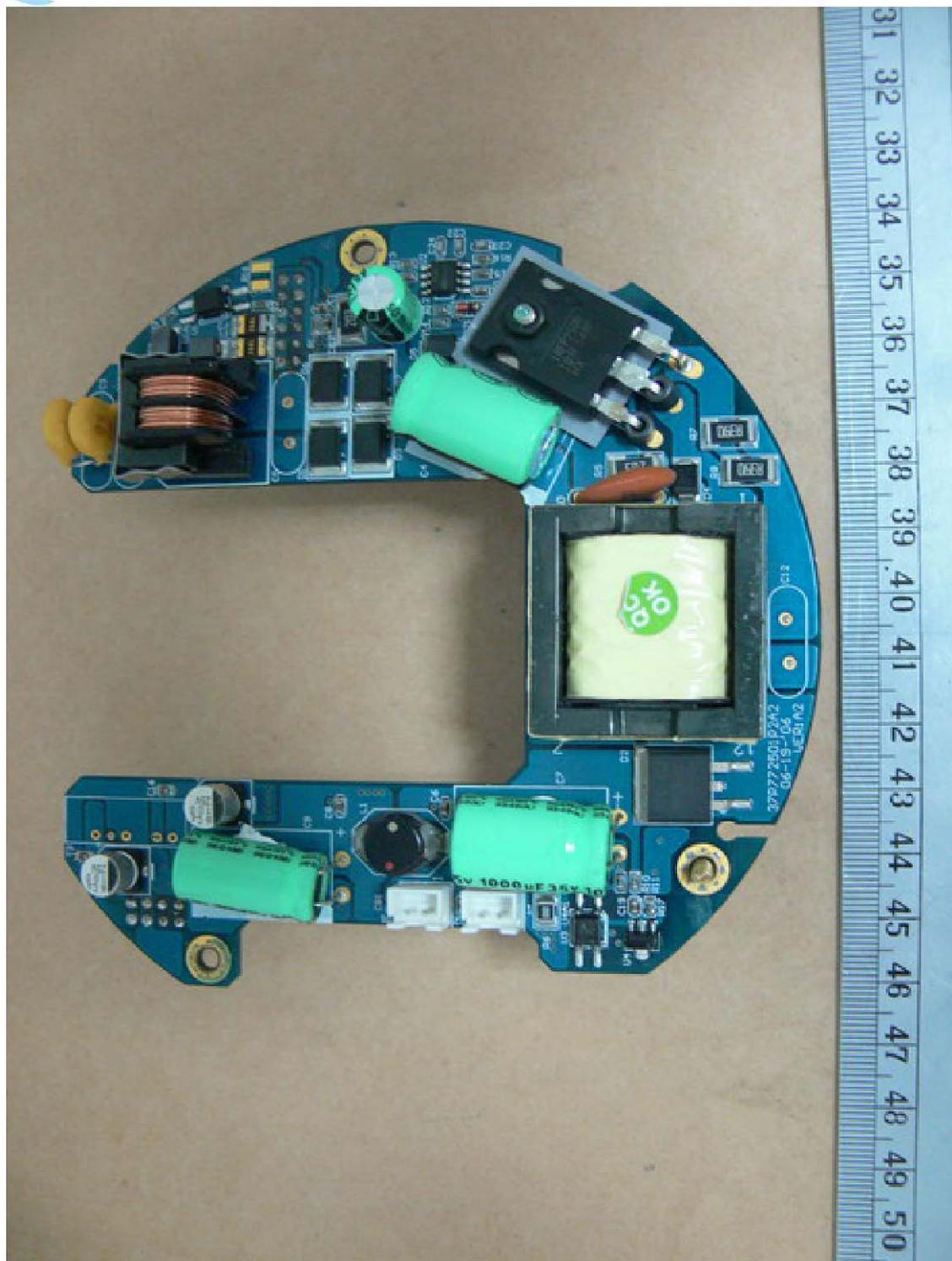

Registration number: W6M20907-9921-E-11



Worldwide Testing Services(Taiwan) Co., Ltd.

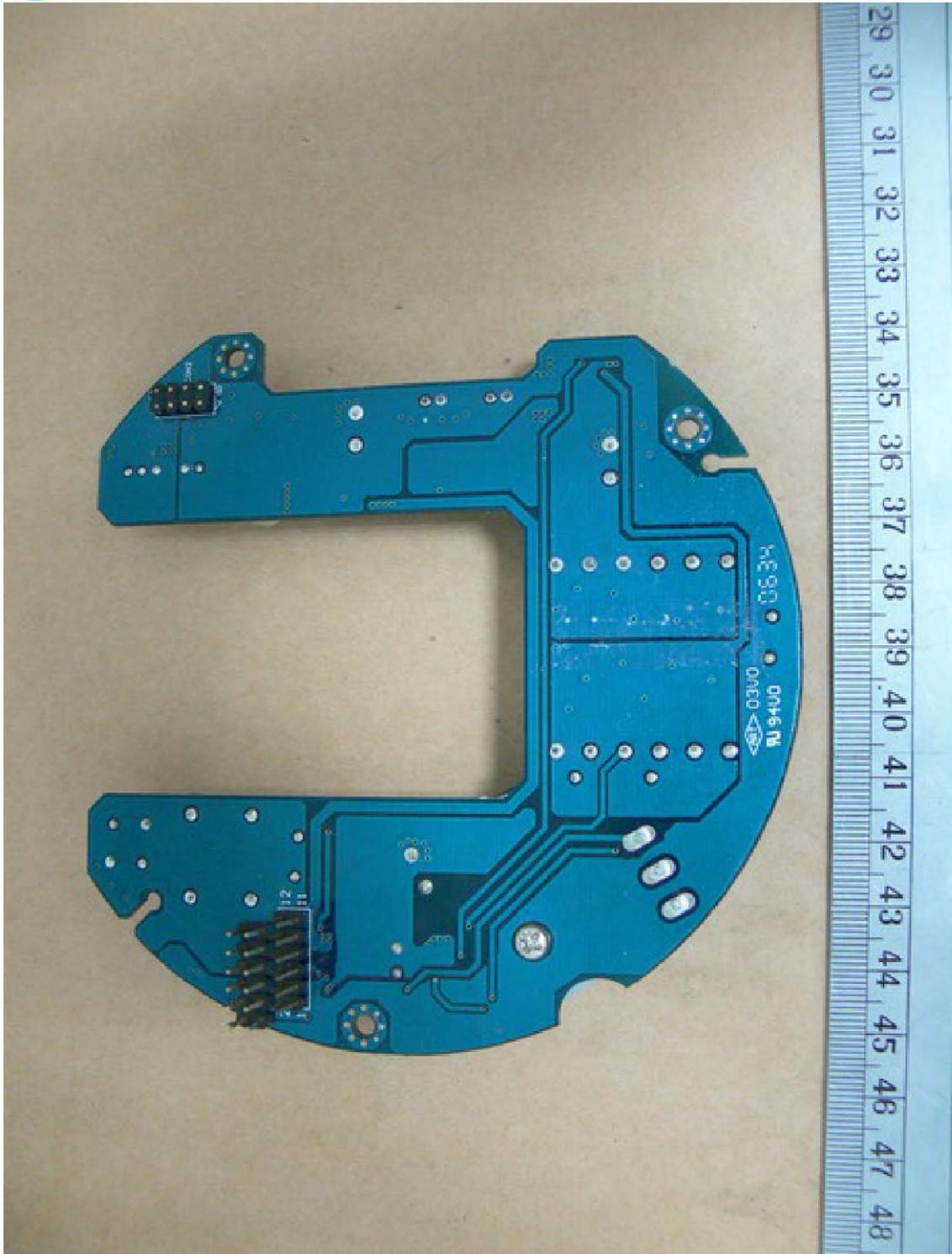

Registration number: W6M20907-9921-E-11

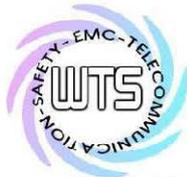

Worldwide Testing Services(Taiwan) Co., Ltd.

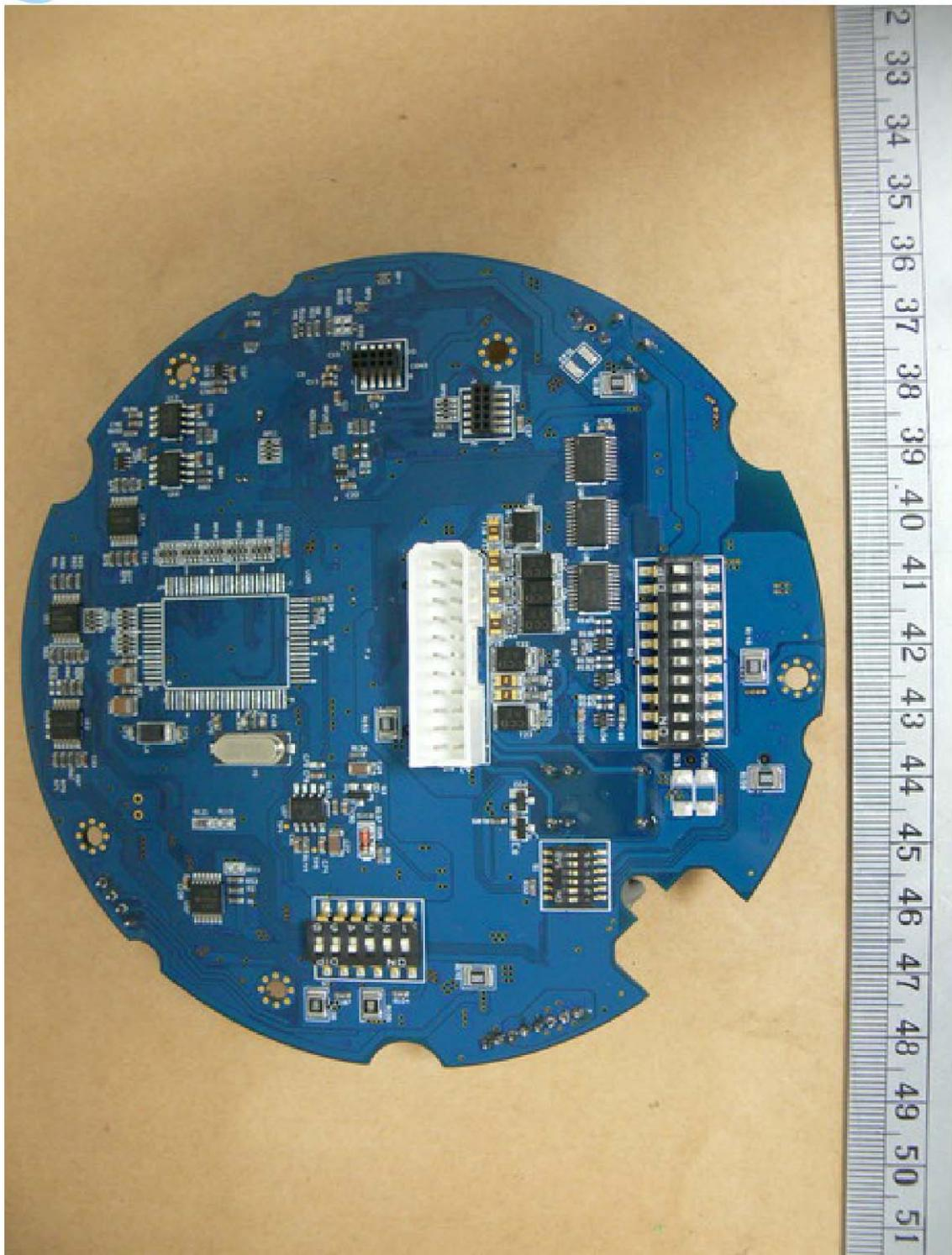

Registration number: W6M20907-9921-E-11



Worldwide Testing Services(Taiwan) Co., Ltd.

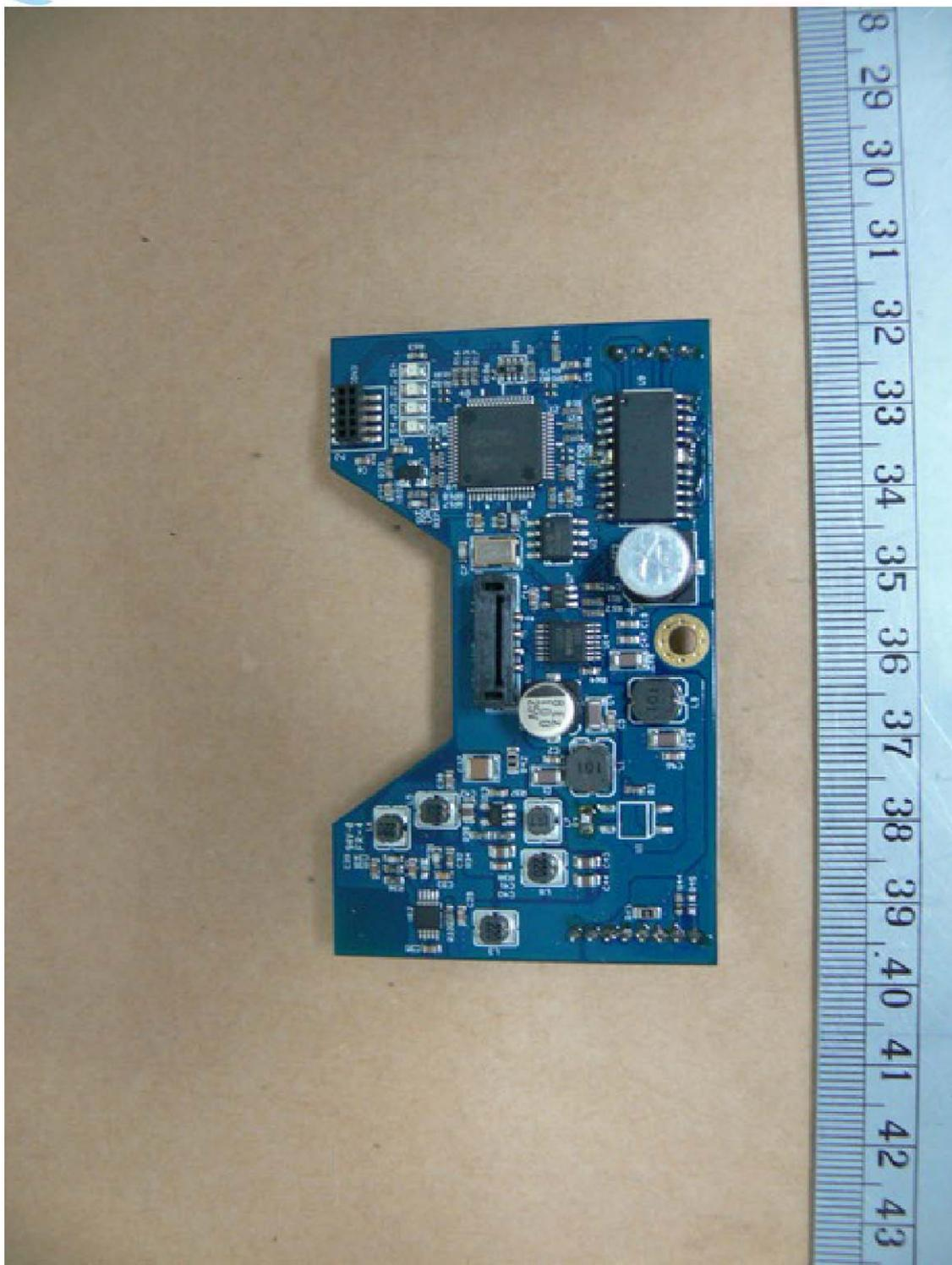

Registration number: W6M20907-9921-E-11



Worldwide Testing Services(Taiwan) Co., Ltd.

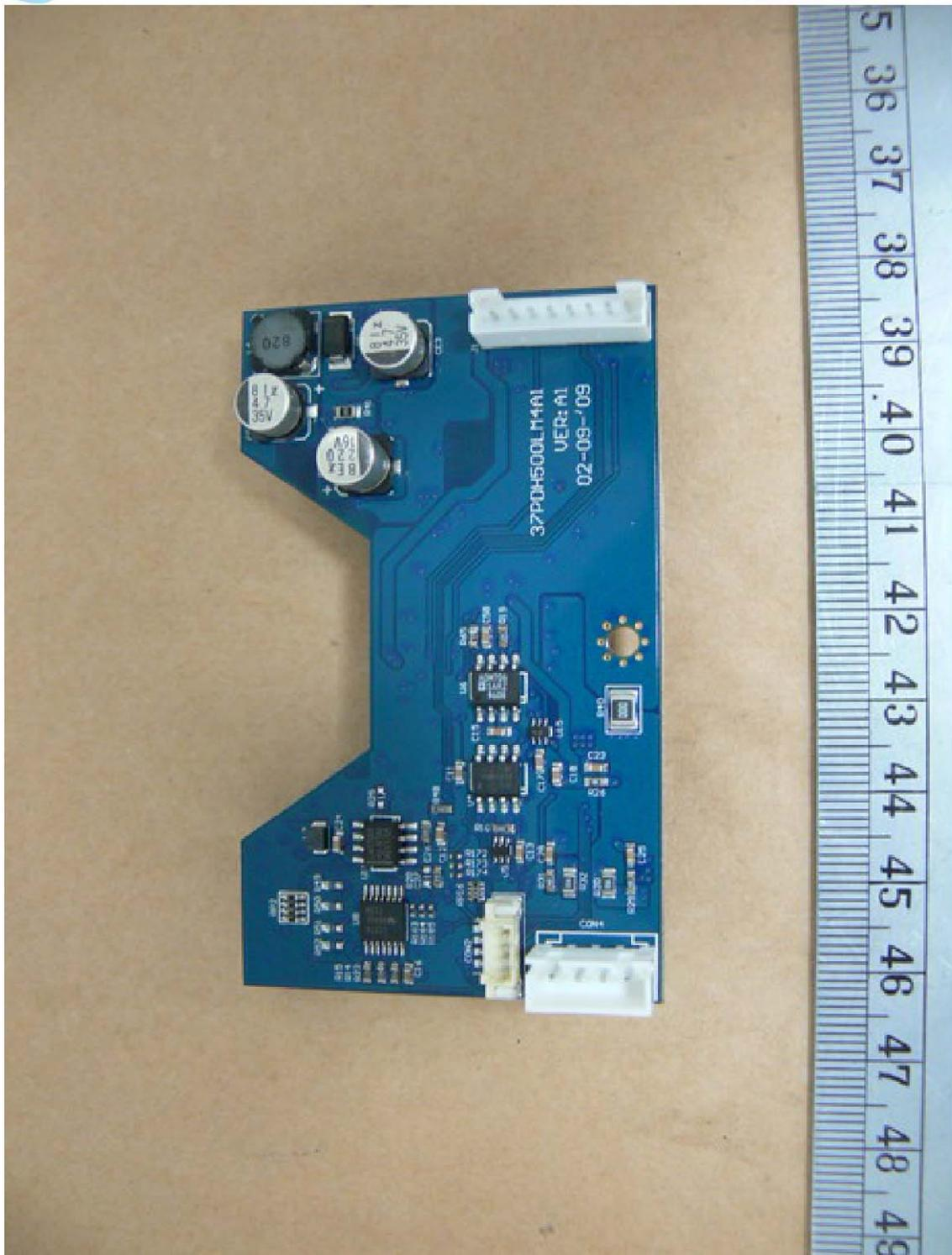

Registration number: W6M20907-9921-E-11



Registration number: W6M20907-9921-E-11



Worldwide Testing Services(Taiwan) Co., Ltd.

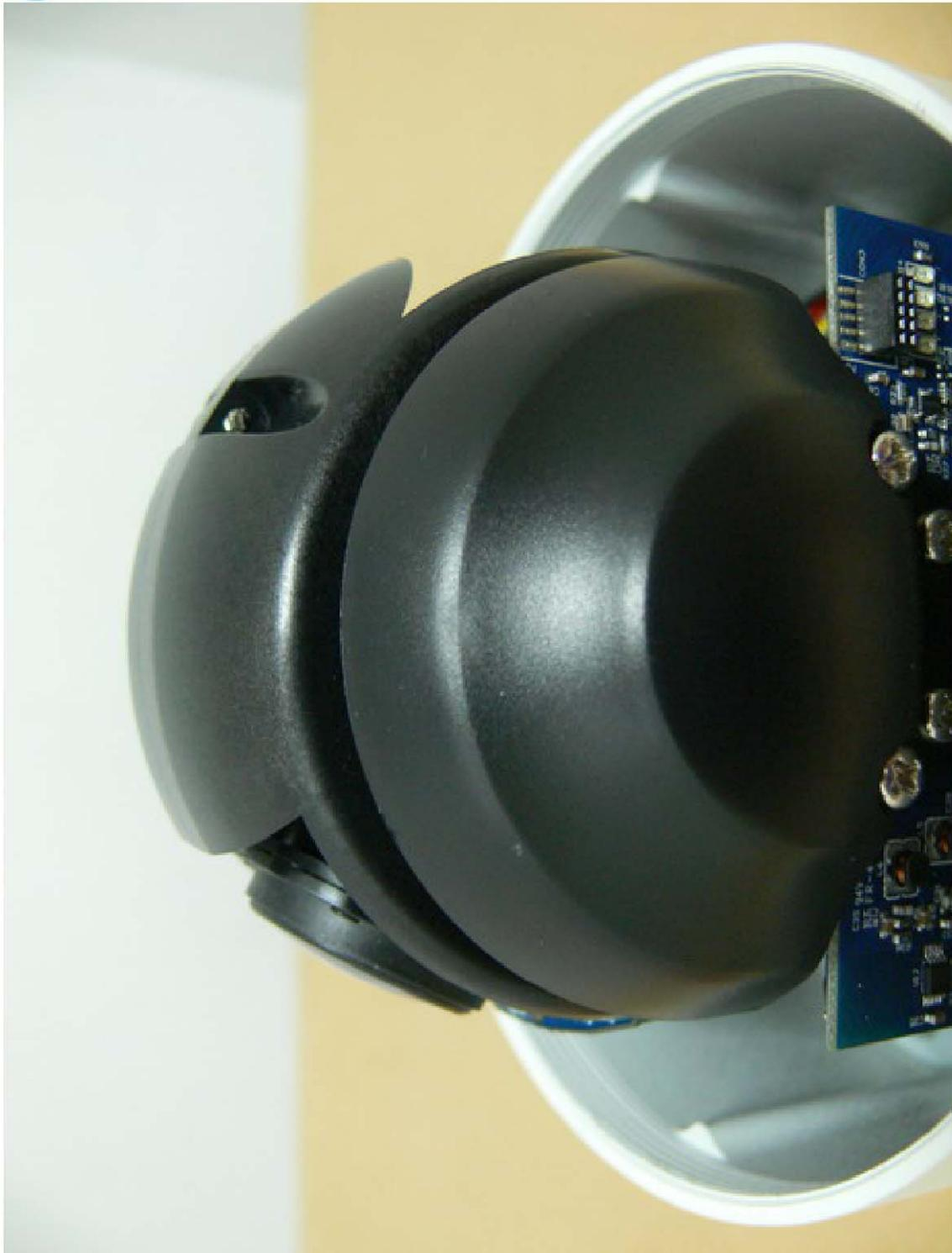

Registration number: W6M20907-9921-E-11



Worldwide Testing Services(Taiwan) Co., Ltd.

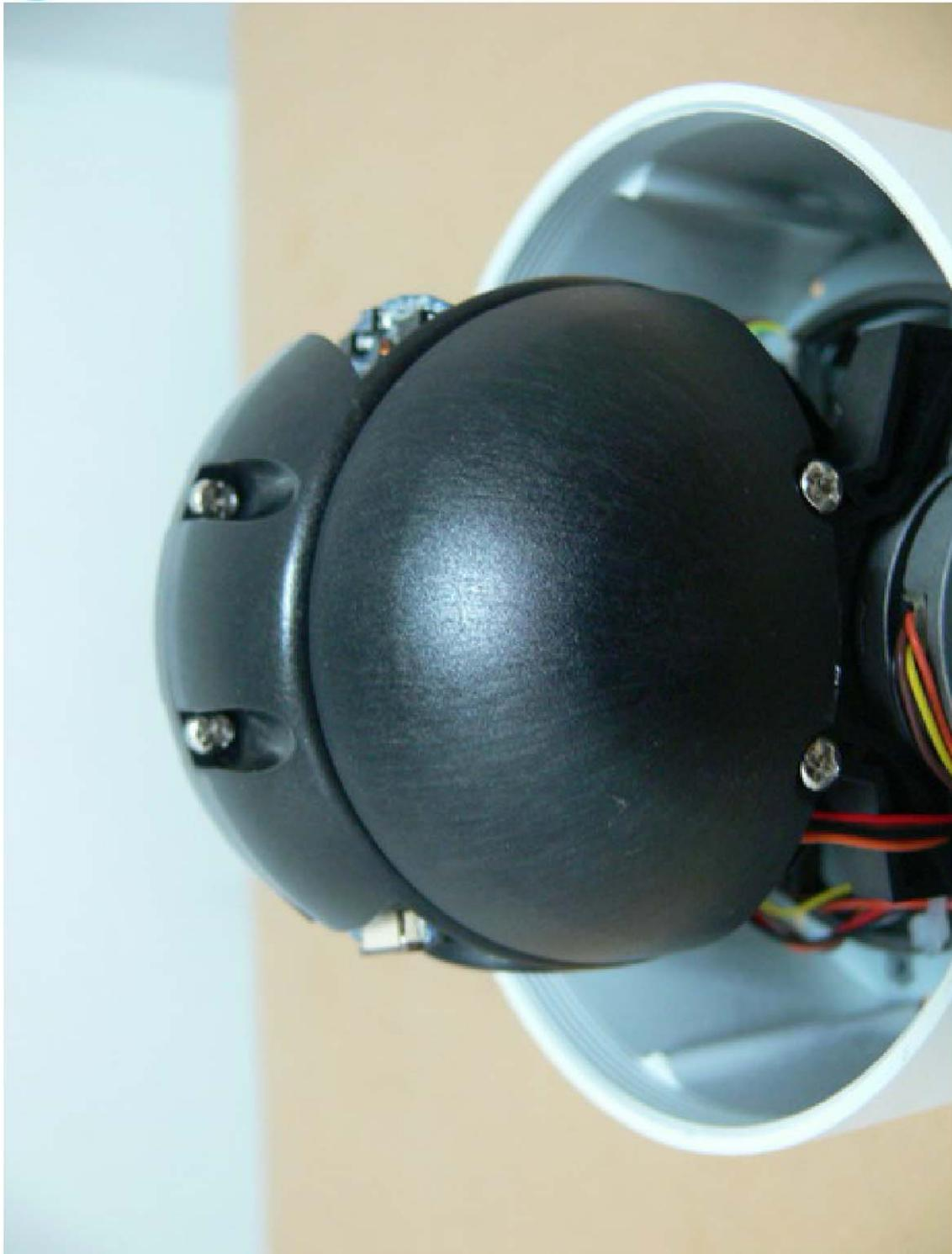

Registration number: W6M20907-9921-E-11



Registration number: W6M20907-9921-E-11

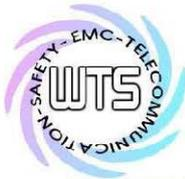

Worldwide Testing Services(Taiwan) Co., Ltd.



Registration number: W6M20907-9921-E-11



Worldwide Testing Services(Taiwan) Co., Ltd.

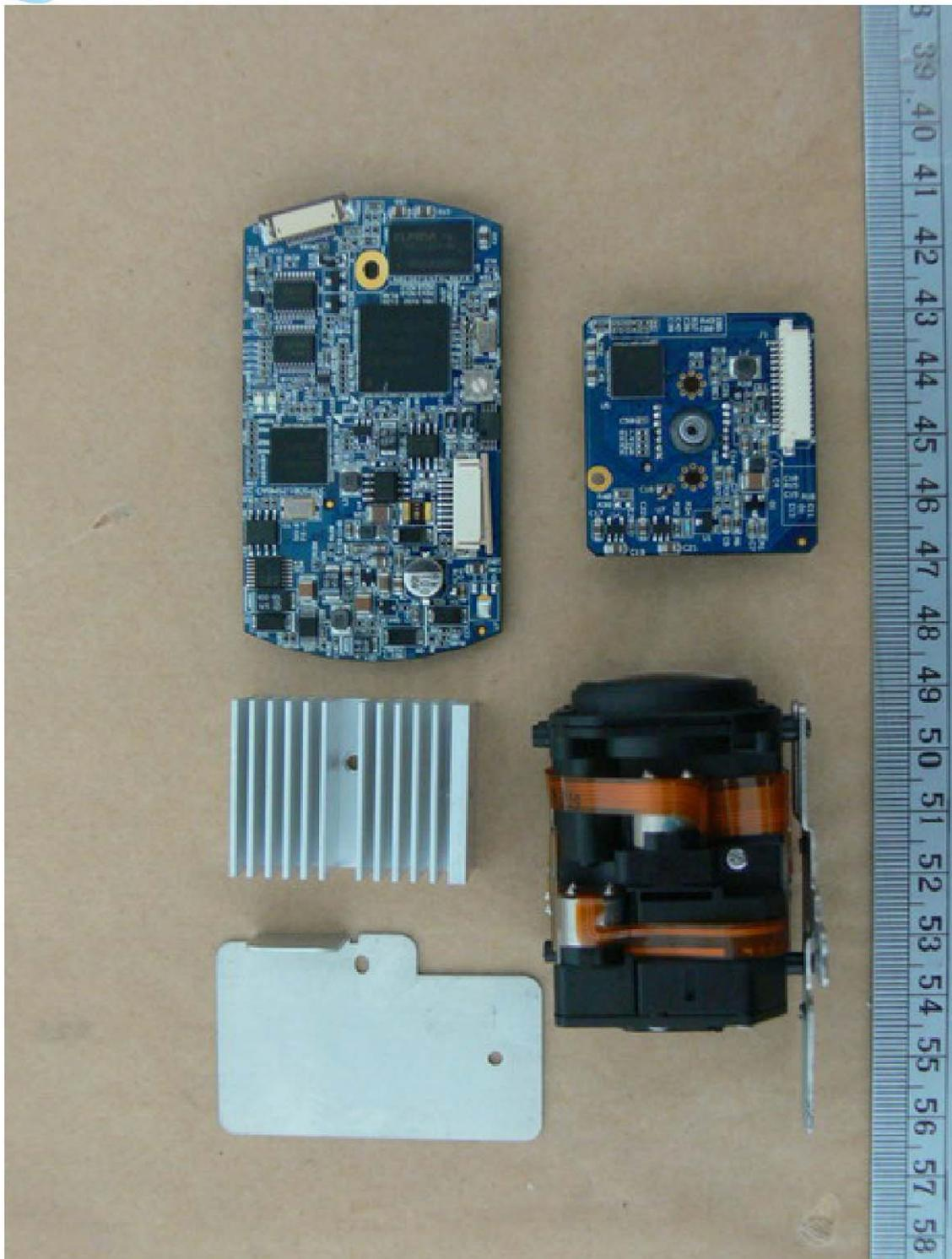

Registration number: W6M20907-9921-E-11



Worldwide Testing Services(Taiwan) Co., Ltd.

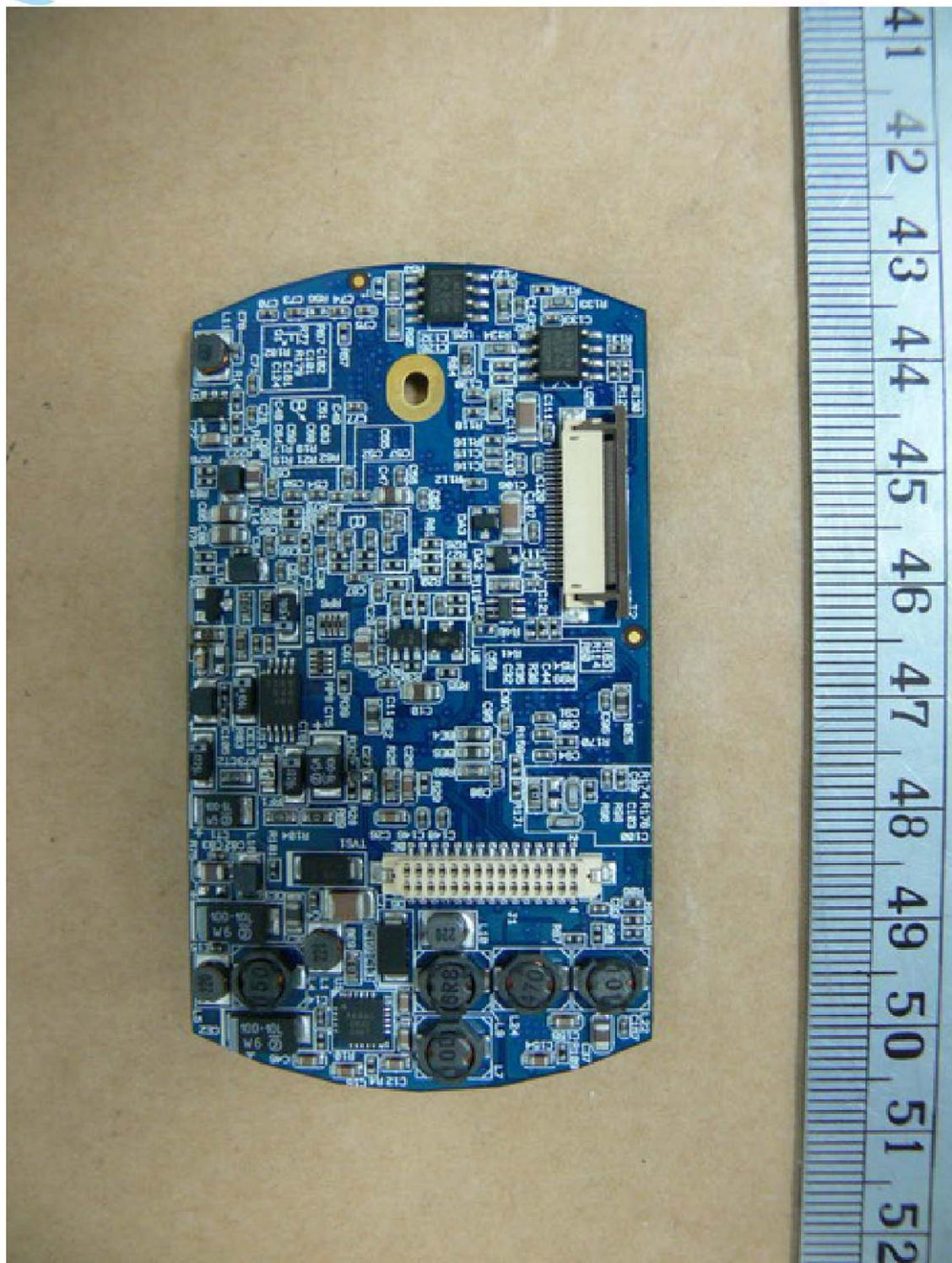

Registration number: W6M20907-9921-E-11

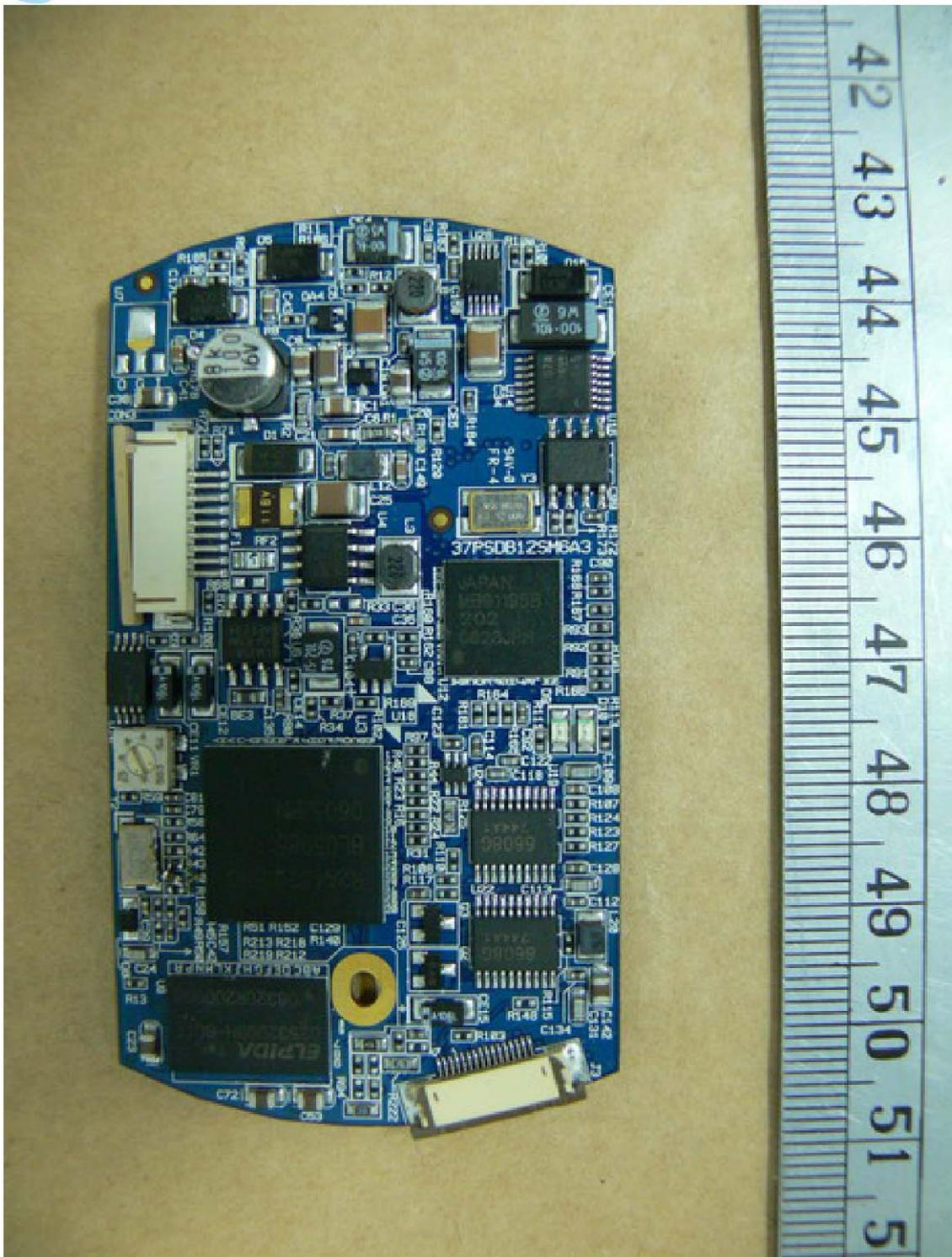

Registration number: W6M20907-9921-E-11



Worldwide Testing Services(Taiwan) Co., Ltd.

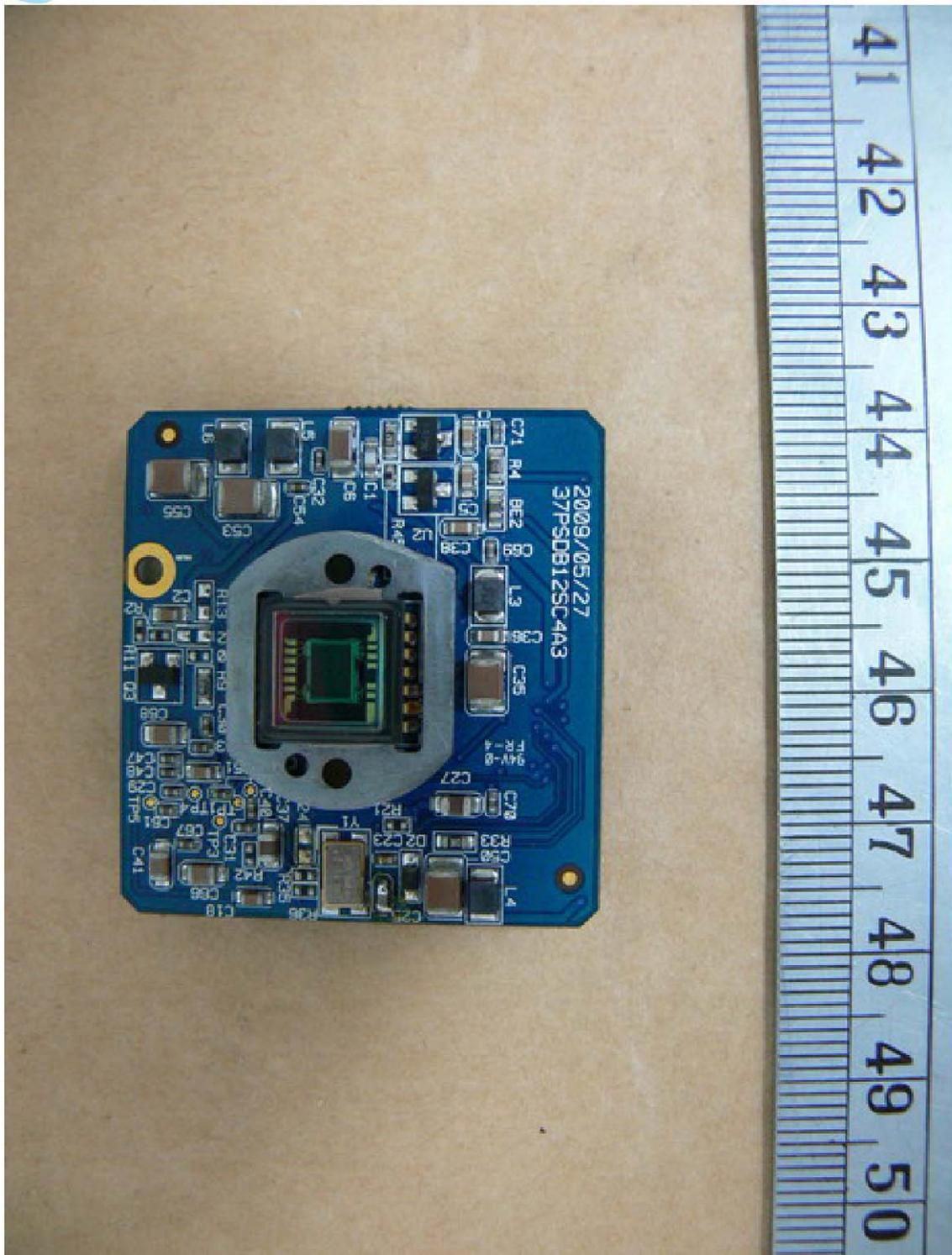

Registration number: W6M20907-9921-E-11



Worldwide Testing Services(Taiwan) Co., Ltd.

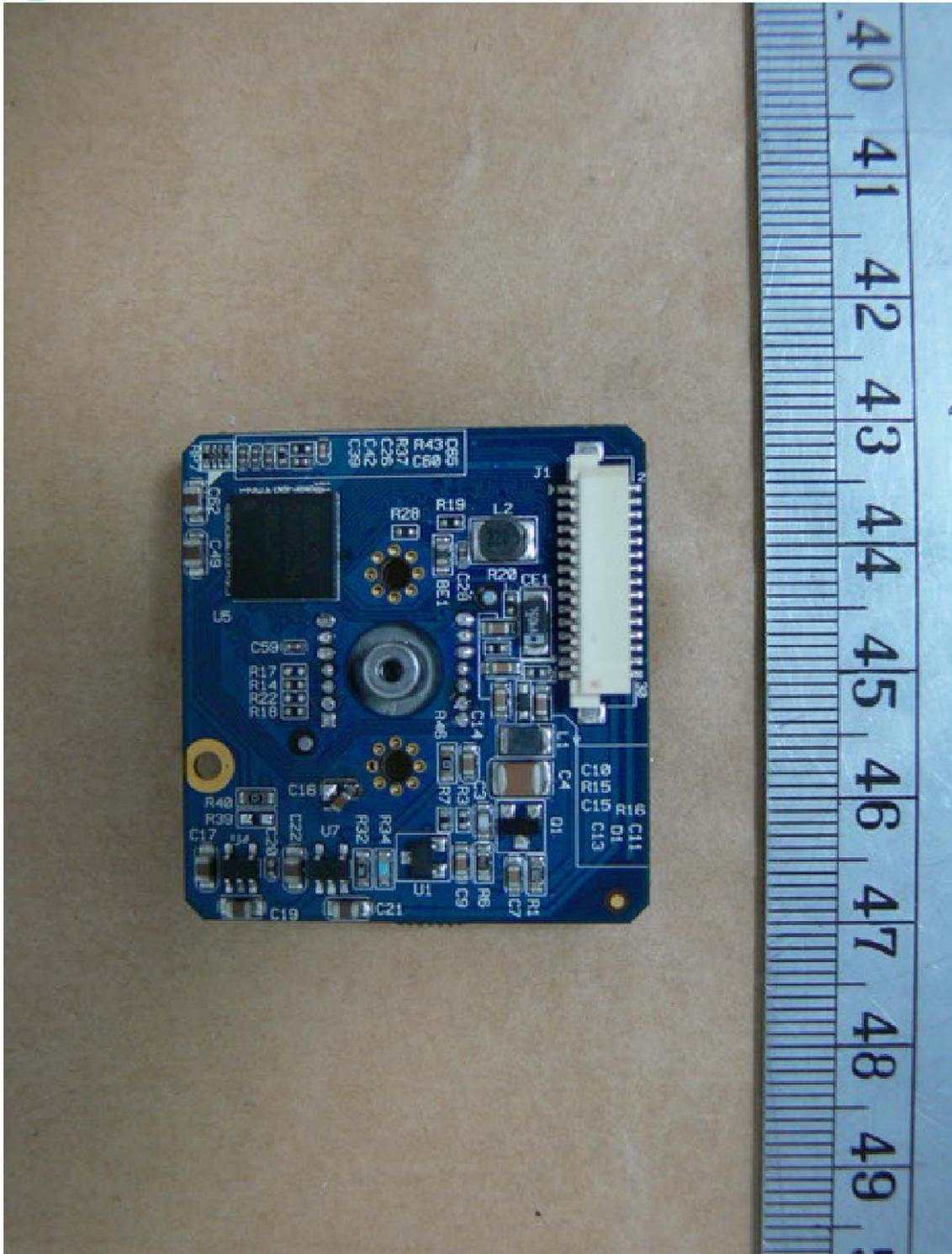

Registration number: W6M20907-9921-E-11



Worldwide Testing Services(Taiwan) Co., Ltd.

Multi-listing model no.: DH510xxxxxxxx (x=0~9, A~Z or space)



Registration number: W6M20907-9921-E-11



Worldwide Testing Services(Taiwan) Co., Ltd.



Registration number: W6M20907-9921-E-11



Worldwide Testing Services(Taiwan) Co., Ltd.

Set Up Photo of Radiated Emission



Registration number: W6M20907-9921-E-11

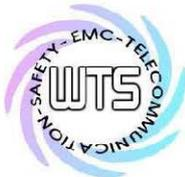

Worldwide Testing Services(Taiwan) Co., Ltd.

Set Up Photo of Conducted Emission



Registration number: W6M20907-9921-E-11



Worldwide Testing Services(Taiwan) Co., Ltd.

Set Up Photo of Current Harmonics& Voltage Fluctuations



Set Up Photo of ESD



Registration number: W6M20907-9921-E-11



Worldwide Testing Services(Taiwan) Co., Ltd.

Set Up Photo of RF-Field



Set Up Photo of EFT



Registration number: W6M20907-9921-E-11



Worldwide Testing Services (Taiwan) Co., Ltd.

Set Up Photo of Surge & V-DIPS



Set Up Photo of CS



Registration number: W6M20907-9921-E-11