



EURACOM[®]

260F, 261F, 262F, 260, 261, 262

Installation manual for PABX systems

ACKERMANN
Systems - that connect

Important notes in advance

No personal registration is necessary for operation of your PABX, as your PABX is prepared to be connected via connector directly to the network termination (NTBA) of your network provider. If you operate your PABX with one or more basic accesses, the installation has to be done by a registered expert, specialized for this subject.

Please pay attention for your own safety:

**ATTENTION!**

Always unplug mains, before opening the PABX.

**ATTENTION!**

Connect or disconnect all connecting cables of your ISDN PABX only with unplugged 230V mains.

**ATTENTION!**

Do not make any installations during a thunderstorm. There is the danger of lightning strikes.

**ATTENTION!**

Be aware of hidden cables and pipes, as e.g. electricity cables, water or gas pipes while drilling holes for installation.

**ATTENTION!**

If you intend to install an internal line of your PABX, leaving the building and going to the outside area, you have to prepare a special lightning protection. Consult your dealer for this matter.

**ATTENTION!**

Equipment may be damaged by electrostatic discharge. Touch a grounded, metallic part (e.g. water or radiator pipe) directly prior to the installation.

Our contribution to environmental protection

- This instruction manual is printed on chlorine-free paper.
- All plastic parts of your PABX consist of fully recyclable material (PC+ABS-FR).

Installing EURACOM

1

Before you start	5
What you should read in any case	5
Defining the symbols	5
Check supply volume	6
Connect to mains	6
Select place for installation	6
Wall mounting	7

Configure EURACOM

2

Connecting systems of EURACOM 26x and 26xF - differences	8
Description of connectors	9
And this is how you connect the PABX	10
Connect analogue subscribers	11
Connecting and disconnecting of analogue subscribers of EURACOM 26xF	11
Connect internal ISDN subscribers	12
Wiring of internal S₀ bus for terminal equipment operation	13
Connect external music source for music-on-hold	14
Connect sensor and actor	14
Connect door intercommunication system (DIS)	15
Connect telecommunication earth	16
Connect PC and printer	17
Establishing EURO ISDN connection	18
Connection variants for EURACOM 260F, 260	18
Connection variants for EURACOM 261F, 261	19
Connection variants for EURACOM 262F, 262	20
Multiple subscriber connection	22
PABX connection	22

Table of contents

Upgrading EURACOM

3

Special features of the second S₀ interface	23
Internal operation of the second S ₀ interface	23
External operation of the second S ₀ interface	24
Power failure and emergency functions	25
Emergency function	25
Connecting two PABX in a network	26
Networking choices	26
Connection variants for networked PABXs	28
Configuration of EURACOM 26xF, 26x as master PABX	28
Link via the 2 nd S ₀ port	28
Link via an MS ₀ module (3 rd / 4 th S ₀ port)	28
Configuration of EURACOM 26xF, 26x as slave PABX	29
Link via the 2 nd S ₀ port	29
Link via an MS ₀ module (3 rd / 4 th S ₀ port)	29
Wiring of networked PABXs	30
Configuration of networked PABXs	30
What can be upgraded, and what is the performance?	31
MS ₀ module	31
MD module	31
Upgrading with MS₀ module	32
Upgrading with MD module	33
Technical data	34
System 261F, 261 and 262F, 262 with variable digital Euro- ISDN-ports	36

By purchasing the Ackermann EURACOM 260F,261F, 262F or EURACOM 260, 261, 262 ISDN PABX, you have decided in favour of a high-quality and future-compatible product. This system provides all the advantages of the digital Euro-ISDN network (DSS1) when connected to a multiple subscriber – or PABX connection while allowing you to continue using existing analog terminal devices.

Thanks to the update capability of this system – either via software in the case of the EURACOM 260F, 261F and 262F or by replacing the program module in the case of the EURACOM 260, 261 and 262 – you can comfortably make use of the features of modern digital communication not only today, but also tomorrow.

And our development work continues. **Which is why the manufacturer reserves the right to change hardware and software specifications, as well as the operating instructions, without prior notice.**



Before getting started

Please read this instruction manual carefully, in order to be able to install your PABX correctly. The supply volume of your PABX covers a comprehensive documentation:

- an instruction manual “Installation”
- an instruction manual “Configuration”
- an instruction manual “User”

The instruction manual “Installation” you are reading just now, first only covers the informations you need to install your PABX. You can thus start with the individual configuration of your PABX rather quickly or keep the presettings.

What you should read in any case

Do read the chapter safety instructions (see inner side of cover) and also the isolated safety instructions (with symbols  and ) in this instruction manual.

Defining the symbols



ATTENTION!

Chapters marked this way indicate possible dangers for persons.



ATTENTION!

Chapters marked this way indicate possible dangers for the system, caused by electrostatic discharge

Check supply volume

Check the supply volume on the basis of your order. The supply volume has to include the following parts in any case:

- EURACOM PABX
- Instruction manual "Installation"
- Instruction manual "Configuration"
- Instruction manual "Operation"
- CD with PC programmes under the cover of the instruction manual "Configuration".
- S₀ connecting cord
- Cord for connection of PABX / PC
- Adapter 9-pin to 25-pin
- Rawel plugs and screws
- Connectors

Do not throw away the box of your PABX necessarily. If you intend to place your PABX in a different place, you can carry it in the box easily and safely (in case of moving, guarantee). If you still want to throw away the box, please make sure to take it to the appropriate recycling areas.

Connect to mains

- ▶ First connect your PABX to the 230V mains after installation and check of all connections and with closed cover.
- ▶ Connect your PABX to a separate mains circuit. You thus avoid having a system breakdown, if there is a short circuit, caused by other appliances.

Select place for installation

Install your PABX in a dry and explosion-proof place. The ambient temperature must not exceed the area from 5°C to 40°C. The minimum distance of your PABX to other limitations shall be 10 cm. Install the PABX with the connectors facing downwards to a plane, strong wall.

Do not install your PABX

- near air conditioning units, radiators
- near appliances with illegal radiation
- in wet places or places with direct sunshine
- in an extremely dusty surrounding
- in a place, where it might be exposed to chemicals

Wall mounting



ATTENTION!

Be aware of hidden cables and pipes, as e.g. electricity cables, water or gas pipes while drilling holes for installation.

In case of wiring underneath the plasterwork, mount your PABX in such a way, that the corresponding cables run through the clamp area openings of the underside. You can screw your PABX to a wall on three fixing points as follows:

- ▶ Remove the clamp area cover of the PABX. In order to do this, grip the cover lid with both thumbs on the top edge and press the lid towards the front.
- ▶ Mark fixing hole P1 on the corresponding wall, drill hole, insert rawlplug and insert screw.
- ▶ Hang PABX onto the screw, adjust horizontally and mark fixing points P2 and P3. Remove PABX again.
- ▶ Drill holes for fixing points P2 and P3 and insert rawlplug.
- ▶ Hang PABX onto screw P1 and fasten it with screws P2 and P3.

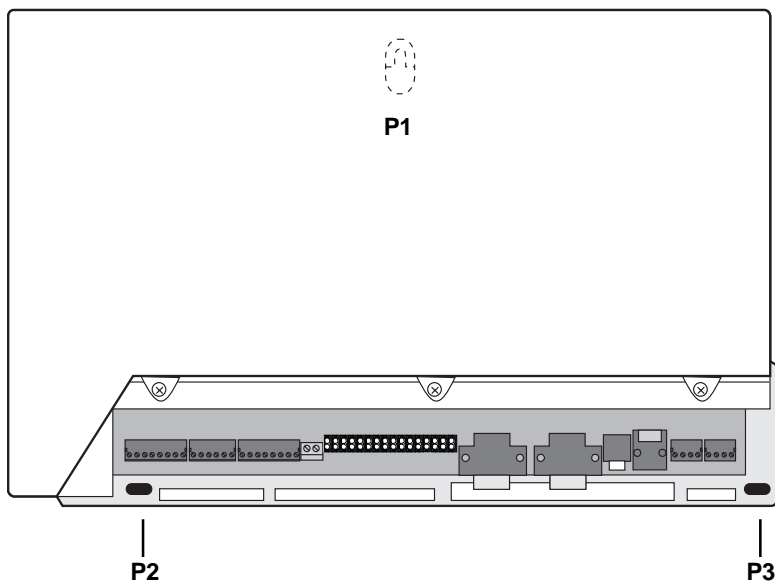

View of the fixing points for mounting the PABX on a wall.

Installation systems EURACOM 26x and 26xF - differences

Depending on the type of your PABX you will discover a different connection technique between EURACOM 26xF and EURACOM 26x PABXs. Specially in the connection area of the analogue ports both PABX types differ from each other concerning the connection technique.

Connection system of EURACOM 26x

The connection of the analogue subscribers (also depicted as analogue ports) is done via a 16-pin plug-in screw clamp with 4 pins for connection of the 2nd S₀ interface. The installation wire is inserted into the front opening in this case and fastened with screw from the upper side. The clamp indication is printed onto the screw clamp.

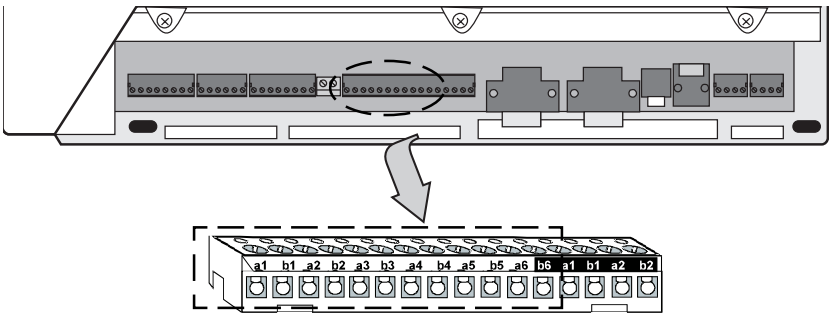

Clamp connector assignment in case of connection of 6 analogue subscriber and the 2nd S₀ interface to a EURACOM 26x

Connection system of EURACOM 26xF

The connection of the analogue subscribers (analogue ports) is done via a 16-pin plug-in cage clamp. You can use only 12 pins from a1 to b6. The other 4 pins will be used for the 2nd ISDN interface. The installation wire is inserted into the opening and then engages. The clamp indication is printed onto the cage clamp.

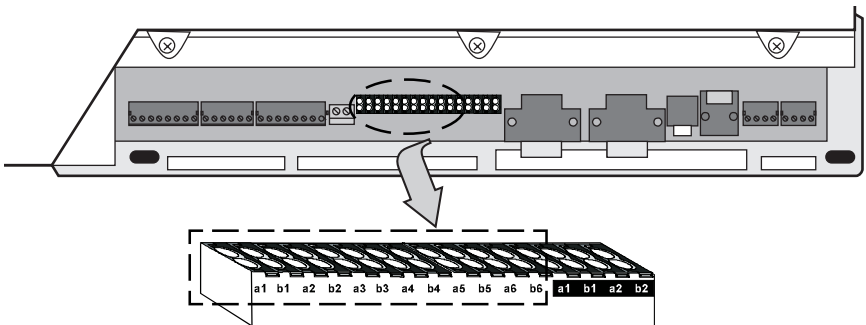

Port1 Port2 Port3 Port4 Port5 Port6 2.S₀

Clamp connector assignment in case of connection of 6 analogue subscribers and the 2nd S₀ interface to a EURACOM 26xF

Description of connectors

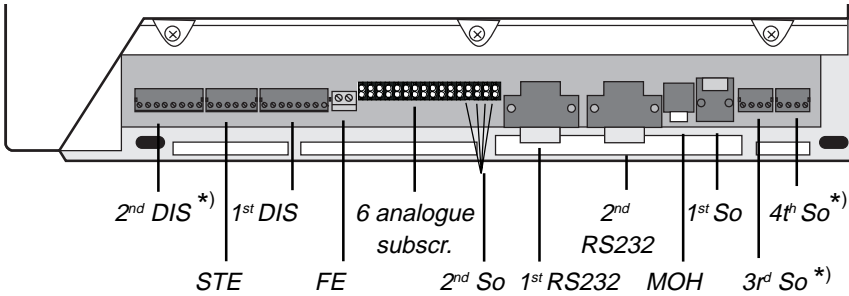

Interface name	Name of connector	What is the function of the interface?
1 st S ₀		1. ISDN-interface, basic network access (Western socket)
2 nd S ₀	a1 b1 a2 b2	Connector for internal/external ISDN port
3 rd S ₀ *)	a1 b1 a2 b2	Connector for internal/external ISDN port (EURACOM 261F, 261)
4 th S ₀ *)	a1 b1 a2 b2	Connector for internal/external ISDN port (EURACOM 262F, 262)
1 st DIS	KT-KT' a-b TO-TO' TS-TS'	Connectors for potential free bell push key Speech circuit, DC free Connectors for control of door release relay Connectors for a relay
2 nd DIS*)	KT-KT' a-b TO-TO' TS-TS'	Connectors for potential free bell push key Speech circuit, DC free Connectors for control of door release relay Connectors for a relay
STE	S1-S1' A1-A1', A2-A2'	Connectors for potential free alarm contact Connectors for control relay 1 and 2 or for secondary ringer 1 and 2
FE		Telecommunication earth
6 analogue subscr.	a1-b1 .. a6-b6	Connectors for analogue terminal equipment
1 st und 2 nd RS232		serial interfaces for printer or PC
MOH		Connector for external music source (music-on-hold)

*) These interfaces are integrated into the PABX, but can only be activated however by use of an upgrade module!

And this is how you connect the PABX

- ▶ Insert all cables through the opening of the clamp area.
- ▶ If you decide to connect a EURACOM 260, 261 or 262, then connect the plug-in screw clamps (part of supply volume) to the installation wires. The clamp indication is printed onto the screw clamps.

If you decide to connect a EURACOM 260F, 261F or 262F, then first connect the wires of the analogue subscribers to the cage clamps and then all other wires to the plug-in screw clamps (part of supply volume). The clamp indication is printed onto all of the cage clamps.

Assign the right wire to the different clamp connections.

- ▶ Plug the screw clamps into the corresponding socket places (--> drawing on page 8).
- ▶ Plug the included ISDN connection cord into the socket of the first PABX S₀ interface. Plug the remaining end of the cord after completed installation of all connections and with closed housing into the line socket of your ISDN basic access.

ATTENTION!



If you intend to install an internal line of your PABX, leaving the building and going to the outside area, you have to prepare a special lightning protection. Consult your dealer for this matter.

Connect analogue subscribers

You are able to connect 6 analogue subscribers by connecting them with both of the related wires to the desired clamps (port 1 to port 6) in correspondence with the connector's name. The polarity of the wires is not essential.

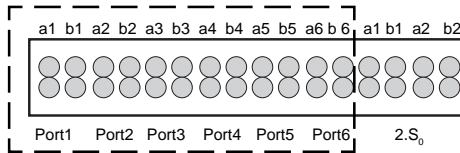

Connector positions for connection of 6 analogue subscribers

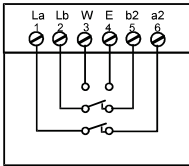
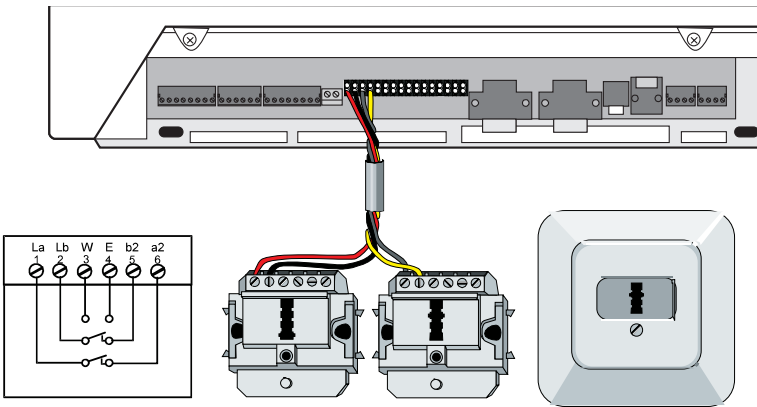

Connection of analogue subscribers (from outlet to PABX)

Connecting and disconnecting of analogue subscribers in case of EURACOM 26xF

You should take a pen, eg and press its top onto the orange-coloured edge of the corresponding connection place.

While doing this, you have to insert the wire into the opening or pull it out of the opening again for disconnection (see illustration). It is possible to use the front or back opening of the connector.

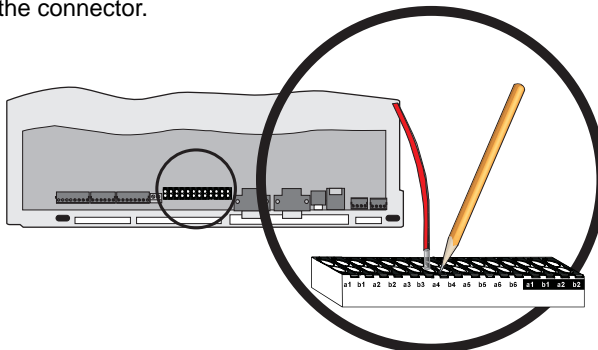

Connect intern ISDN subscribers

You may install up to 12 ISDN outlets on each of the internal S_0 busses and operate up to 8 ISDN terminals, as e.g. ISDN telephones, ISDN PC cards, connected to these outlets. It is also possible to use ISDN terminals, not being equipped with an own power supply. In this case the following combinations are possible:

- 4 ISDN terminals with a power consumption of up to 1 Watt and 4 ISDN terminals without power consumption, e.g. PC cards
- 8 ISDN terminals without power consumption
- a combination, e.g. two ISDN terminals with and 6 without power consumption

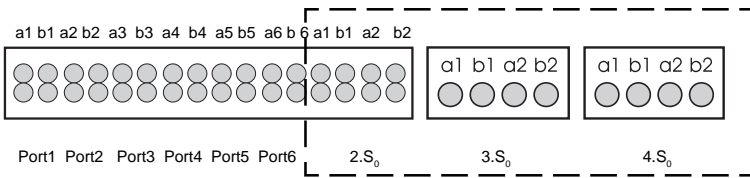

Connector positions for connection of ISDN ports 2, 3 and 4

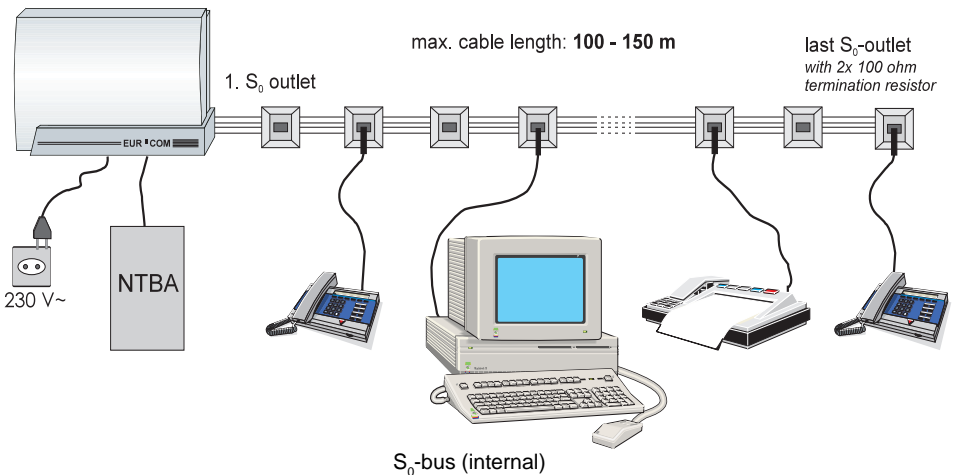

Wiring of internal S₀ bus for terminal equipment operation

- ▶ The wiring of the internal S₀ bus should be carried out according to the connection illustration shown below.
- ▶ The last outlet has to be equipped with a resistor of 100 ohm value each between clamps 3/6 and 4/5 or 1a/1b and 2a/2b (power rating min. 0,25 Watt)

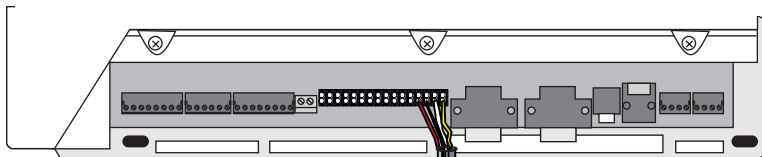

Example for connection of an internal ISDN bus

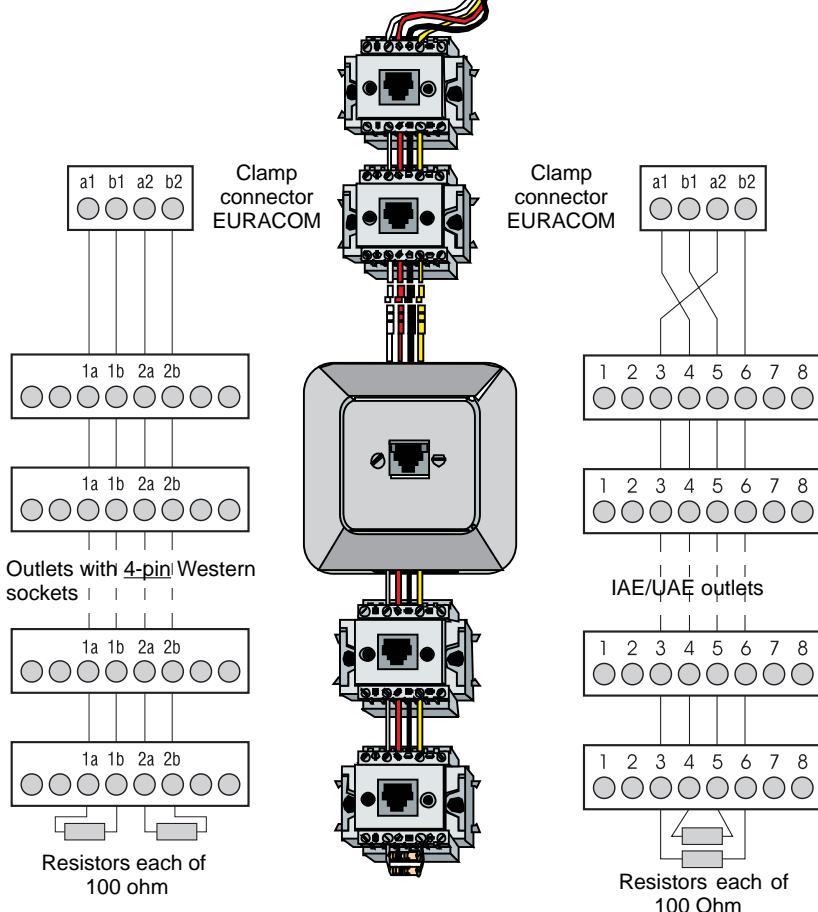

Wiring of the internal ISDN bus

Connect external music source for music-on-hold

It is possible to connect an external music source to your PABX, e.g. CD player or tape recorder. Your callers will then hear, while being in hold condition, an individual music (also known as MOH = music on hold) or an announcement concerning your company.

Connect the external music source via a standard jack plug of 3,5 mm, as shown in the illustration below, to your PABX. The connected appliance for playing the music on hold must be permanently switched on, as far as there is no control through the control contacts.

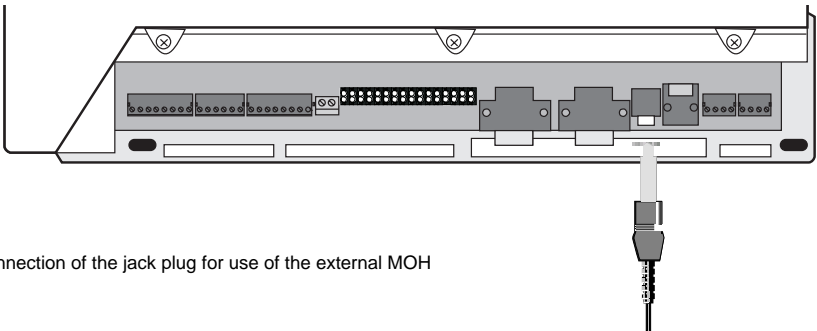

Connection of the jack plug for use of the external MOH

Connect sensor and actor

Your PABX is equipped with different control elements (sensor and actors).
The use of the actors is as follows:

- Alarm contact
- Secondary ringer
- MOH switch
- Manually switched relay

Connect the control elements according to illustration below.



- | | |
|---------|---|
| S1, S1' | Connections for potential-free alarm contact (sensor) |
| A1, A1' | Connections for operation of control relay 1 (actor) |
| A2, A2' | Connections for operation of control relay 2 (actor) |

Connect door intercommunication system (DIS)

You can operate all door intercommunication systems with your PABX, which meet the relevant market standard (FTZ 123 D12).

- Connect door bell, intercom station or door opener according to the following illustration.

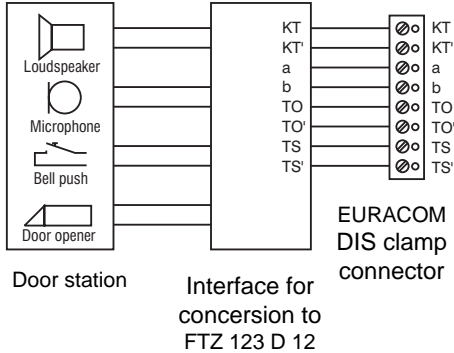

In case of door intercommunication systems according to standard FTZ 123 D12 the interface may be implemented completely or partially. In case of partial implementation it usually covers only the conversion of the listening and speaking circuit to two-wire technology.

In this case connect the bell push key and the door opener separately. You get further informations to this matter from the manufacturer's documentation of the corresponding door intercom system.

You can find examples for the connection of various door stations on our internet homepage (<http://www.ackermann.com>).

Concerning your PABX, there are two complete, separate controllable, door station connections at your disposal. If you intend to control two door stations, you then need the MD upgrade module (option).

- Connect the door stations on clamp connectors 1st DIS and 2nd DIS as shown in the following illustration.

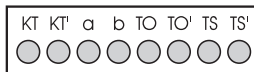

- KT, KT' Connector for potential-free bell push key
- a, b Speaker circuit, DC-free
- TO, TO' Connector for door opener relay
- TS, TS' Control of a relay for switching on an external amplifier (switching of speech path)

- Afterwards configure your PABX (see instruction manual "Configuration", page 66 +)

Connect telecommunication earth

For potential balancing reasons your PABX needs a telecommunication earth.

- ▶ Connect the telecommunication earth (FE) to your PABX by use of a 1,5 mm² wire, as shown in illustration below.
- ▶ Connect the other end of FE to the earth/ground potential of the building or floor, but by no means to the protective earth conductor.

IMPORTANT NOTE!

By no means connect FE via protective earth wire.

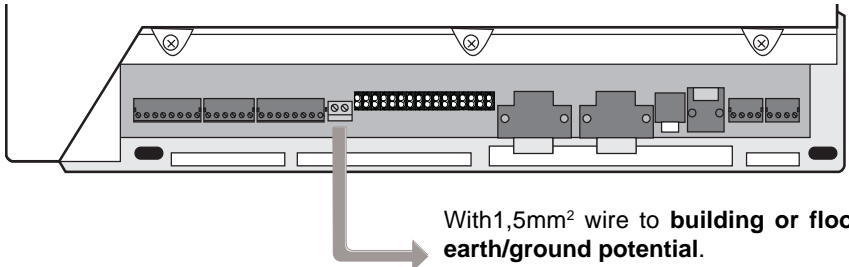

With 1,5mm² wire to **building or floor earth/ground potential.**

Do not connect to protective earth conductor!

Note VDE 0100!

Potential balancing by grounding of the PBX

Connect PC and printer

It is possible to connect your PABX with a PC and a printer via the RS 232 interface by use of an appropriate cable (part of supply volume). You can set the interface parameters of your PABX to the parameters of your PC (--> instruction manual "Configuration", page 44).

If your PC is equipped with a 9-pin connection, use the enclosed V.24 cable. If your PC is equipped with a 25-pin connection, use the enclosed adapter between V.24 cable and PC connection. If you prefer tailoring a cable yourself, please refer to the pinning given in illustrations below. The cable length must not exceed 3 m.

PABX
9-pin D-Sub-plug

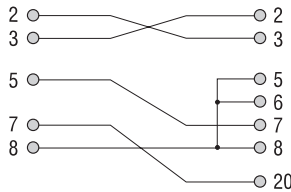

serial printer
25-pin D-Sub-plug

PABX
9-pin D-Sub-plug

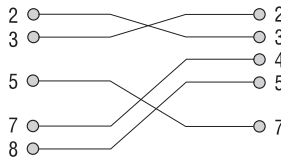

PC
25-pin D-Sub socket

PABX
9-pin D-Sub-plug

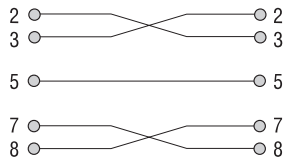

serial printer
9-pin D-Sub-plug

PABX
9-pin D-Sub-plug

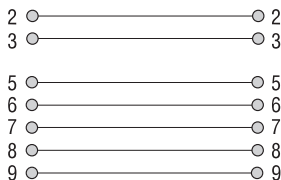

PC
9-pin D-Sub socket
(included)

Establishing EURO ISDN connection

- ▶ Insert the included ISDN line cable into the Western socket (1st S₀) of your PABX.
- ▶ Then insert the other cable end into the S₀ socket of the Euro ISDN network termination (NTBA) installed by your network provider and click the plug in.

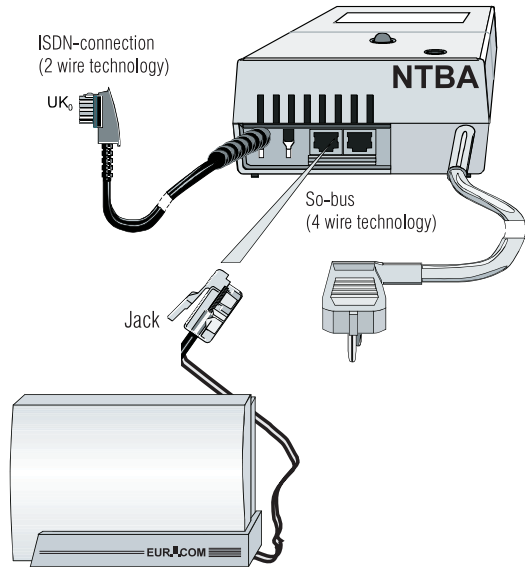

Connection of PABX to an NTBA

Connection variants for EURACOM 260F, 260

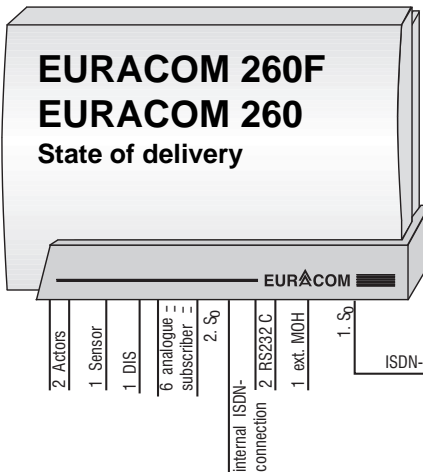

- ISDN basic access modes:
- 1 multiple subscriber mode
 - 1 PABX mode

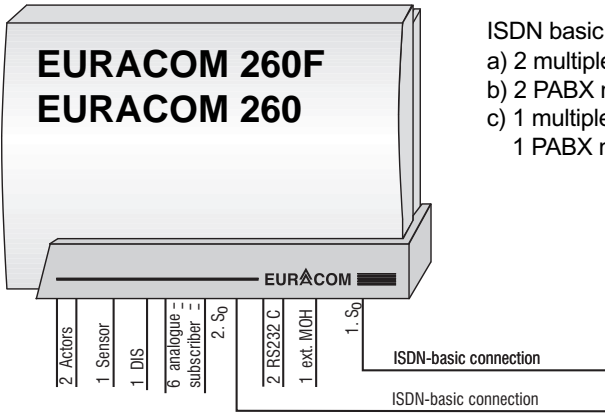

- ISDN basic access modes:
- a) 2 multiple subscriber mode
 - b) 2 PABX mode
 - c) 1 multiple subscriber mode,
1 PABX mode

IMPORTANT NOTE!

If you want to operate your PABX in the above shown constellation, the installation has to be carried out by a registered specialist. Both NTBA must be connected to one exchange. If in doubt, ask your network provider.

Connection variants for EURACOM 261F, 261

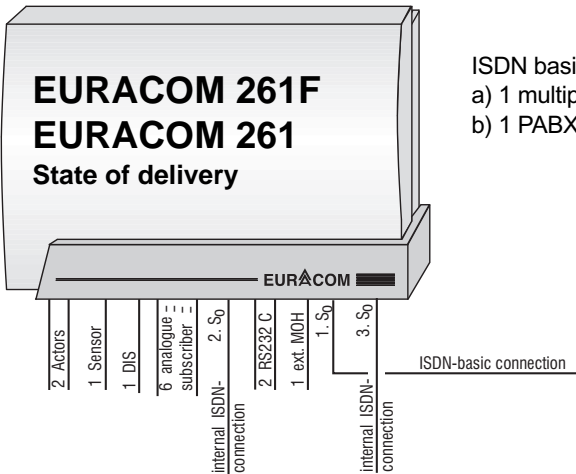

- ISDN basic access modes:
- a) 1 multiple subscriber mode
 - b) 1 PABX mode

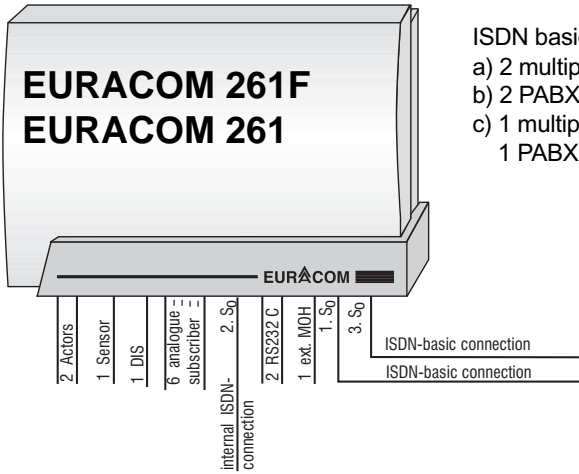

- ISDN basic access modes:
- a) 2 multiple subscriber mode
 - b) 2 PABX mode
 - c) 1 multiple subscriber mode,
1 PABX mode

IMPORTANT NOTE!

If you want to operate your PABX in the above shown constellation, the installation has to be carried out by a registered specialist. Both NTBA must be connected to one exchange. If in doubt, ask your network provider.

Connection variants for EURACOM 262F, 262

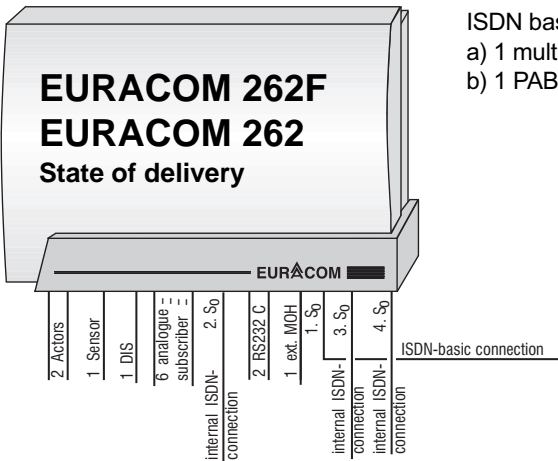

- ISDN basic access modes:
- a) 1 multiple subscriber mode
 - b) 1 PABX mode

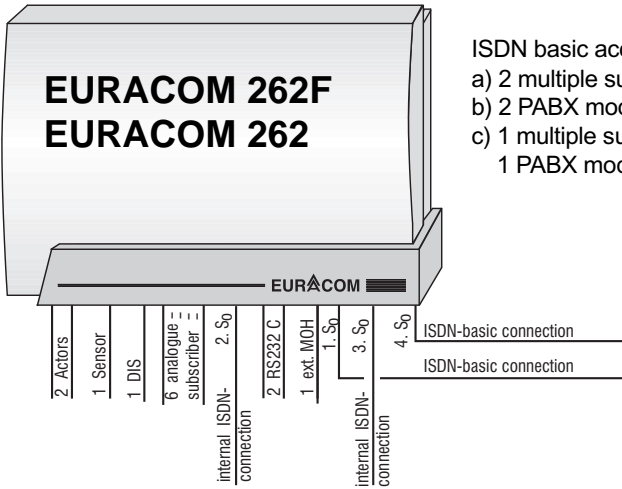

- ISDN basic access modes:
- a) 2 multiple subscriber mode
 - b) 2 PABX mode
 - c) 1 multiple subscriber mode,
1 PABX mode

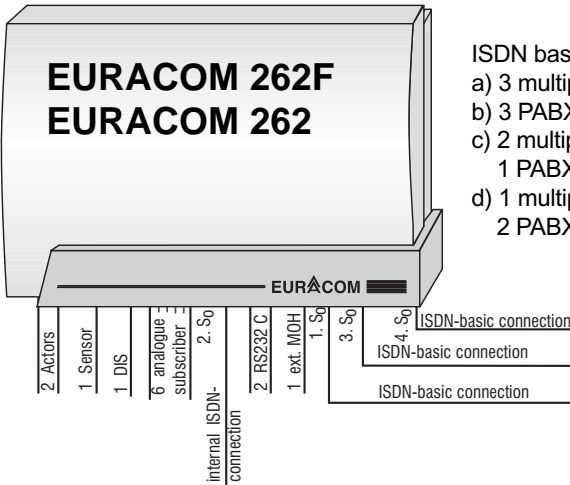

- ISDN basic access modes:
- a) 3 multiple subscriber mode
 - b) 3 PABX mode
 - c) 2 multiple subscriber mode,
1 PABX mode
 - d) 1 multiple subscriber mode,
2 PABX mode

IMPORTANT NOTE!

If you want to operate your PABX in the above shown constellation, the installation has to be carried out by a registered specialist. All NTBA must be connected to one exchange. If in doubt, ask your network provider.

Multiple subscriber connection

An ISDN multiple subscriber connection (point-to-multipoint) allows the installation of up to 8 ISDN terminals. In this constellation the PABX has to be the last equipment on the bus, as the PABX contains the bus termination.

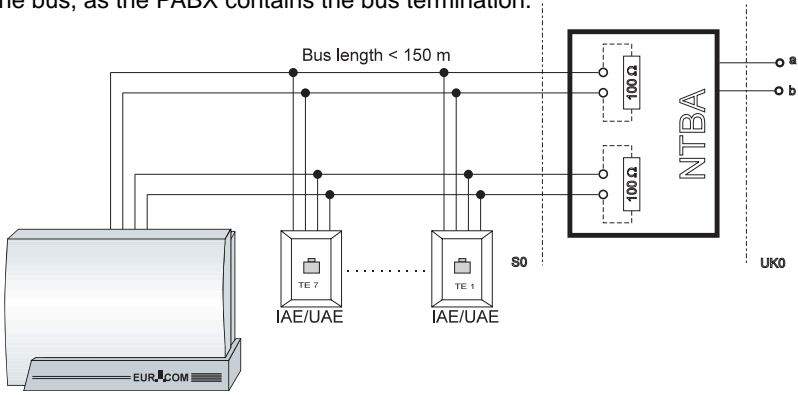

ISDN multiple subscriber connection - point-to-multipoint connection

PABX connection

The PABX connection (point-to-point connection) allows to connect only one equipment, usually a PABX. The outlet, used for the PABX, must not contain any termination resistors, as these are integrated in the PABX. A PABX connection is always prepared for direct dialling in.

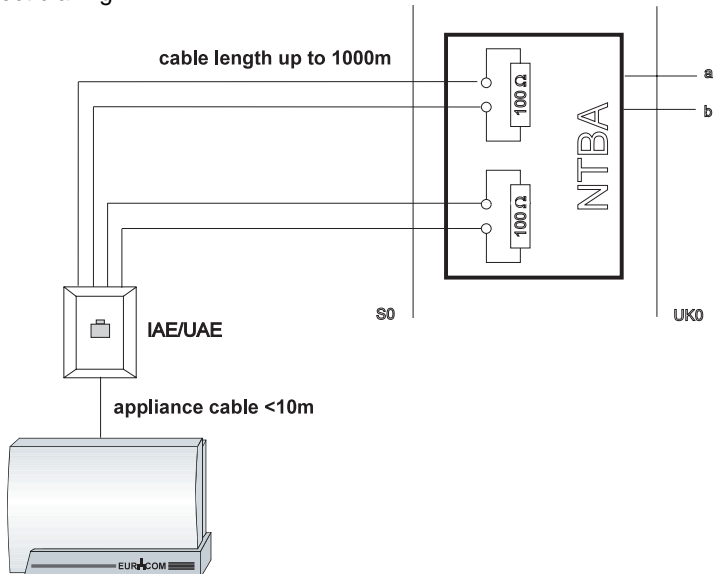

ISDN-PABX connection – point to point connection

Special features of the second S₀ interface

Your PABX is equipped with a second ISDN interface (2nd S₀). You may configure this interface as well for external as also for internal operation.

Internal operation of the second S₀ interface

In state of delivery this second ISDN interface is configured for internal operation, i.e. you are able to connect up to 8 digital terminals.

IMPORTANT NOTE!

It is only possible to connect a maximum of four terminals with a maximum power consumption of 1 Watt each to the internal S₀ bus. If you like to connect further ISDN terminals, these must contain an own power supply.

External operation of the second S₀ interface

If you want to use another basic access, you then have to configure the second S₀ interface as external interface. If you want to operate your PABX with another basic access, the installation has to be carried out by a registered specialist. Both NTBA must be connected to one exchange. If in doubt, ask your network provider.

And this is what you have to do:



ATTENTION!

In any case unplug the mains before opening the equipment!



ATTENTION!

Equipment may be damaged by electrostatic discharge.
Touch a grounded, metallic part directly prior to the installation.

- ▶ Remove the cover of the PABX.
- ▶ Remove the three screws, connecting the upper with the lower cover.
- ▶ Remove the upper cover.
- ▶ Remove the four jumpers from J3 (see illustration, detail B). Set the jumpers of the second S₀ interface (see illustration, detail A) as follows:
J1 position 2/3
J2 position 2/3

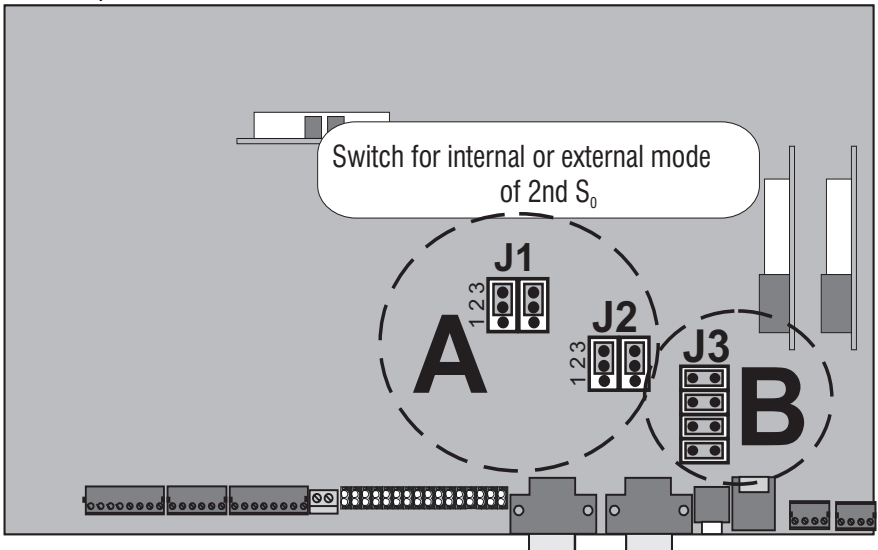

Inside view of the PBX with jumpers for the function of the 2nd S₀ interface in external operation mode (marked illustrations enlarged)

Power failure and emergency functions

Your PABX is powered by the 230V mains. In case of a mains power failure, your PABX can not be operated. However it will store all programmed configuration features, subscriber data and their call transfers.

Emergency function

In case of a mains power failure you are able to operate an ISDN terminal, set for restricted power mode, on the second S_0 port of your PABX. This terminal must fulfill the network access requirements during operation on the public telecommunications network.

Conditions:

Multiple subscriber connection:

- Your telephone must be suited for restricted power authorization (please refer to the manual of your terminal equipment in this case!)
- Only **one** telephone is allowed for restricted power mode.
- You have to set your ISDN telephone to the desired emergency MSN.

Example:

- 1st MSN: internal PABX number
- 2nd MSN: 1st MSN of your connection
- 3rd MSN: 2nd MSN of your connection

PABX connection:

Your telephone must fulfill the requirements for network access, concerning a PABX connection. If not, the four jumpers (see illustration below), being placed in state of delivery, have to be removed.



ATTENTION!

In any case unplug the mains before opening the equipment!



ATTENTION!

Equipment may be damaged by electrostatic discharge.
Touch a grounded, metallic part directly prior to the installation.

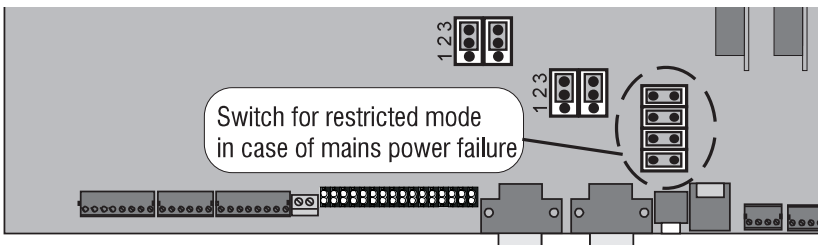

View of the PBX inside area, with switch for restricted mode function (marked illustration enlarged)

Connecting two PABX in a network

It is possible to connect two EURACOM PABXs with each other (build a network). This makes sense e.g., if you have a need for additional analogue or digital terminal equipment, caused by expansion of your company, and you do not intend to change to another larger system. The networking of two EURACOM PABXs means, that two single systems are connected via an ISDN interface. Several functions and behaviours are then controlled by one PABX. Thus the PC programming for both PABXs is performed from one PABX. The numbering plan is established in relation to each other and the communication among the PABXs is done via the internal telephone numbers. Call distribution is effective for the subscribers of both PABXs, as you have programmed in the configuration.

As networking is operated via an ISDN interface, also the principles of ISDN connections are applicable, i.e. only two simultaneous connections can be operated via this interface. In times of high telephone traffic blockages may occur during dialling process, if e.g. connections are not possible any more via this interface. With networking, the data of both PABXs are coordinated with each other. This means e.g., that identical speed dialling numbers are provided in both PABXs. The number of sets of charging information covers approximately 750 each for a PABX, as each PABX stores the charging information independently. But they are read and deleted together.

In a network you have to determine, which of the two PABXs shall be operated as master (A system) and which as slave (B system). This is necessary, as you can only perform the configuration by PC for both PABXs via the master PABX. Both PABXs can only be connected with each other via an ISDN interface (S_0), being configured as direct cross link port.

Networking choices

The table on next page shows you the networking choices of several PABXs. From this it can be seen, that the PABXs EURACOM 141F, 141 and EURACOM 180F, 180 can only be operated as slave PABX (B system). Each of the crosses denotes, whether the mentioned S_0 port can be used as internal, external or directly cross linked port.

Connecting two PABX in a network

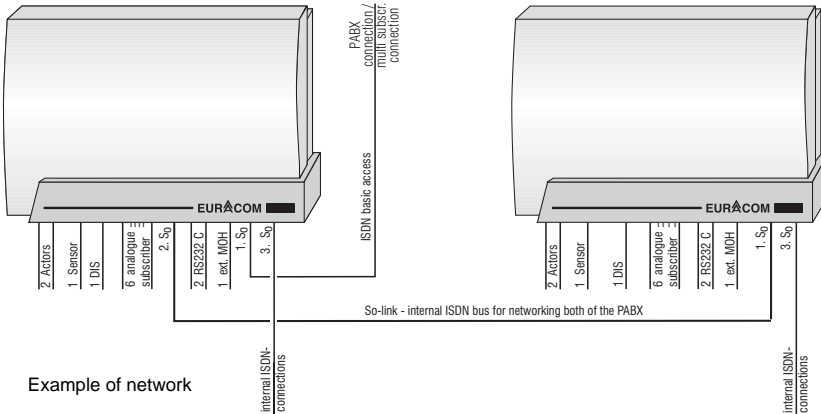

Example of network

EURACOM	S ₀ -Port	A-system			B-system		
		internal	external	cross link	internal	external	cross link
141F, 141	1						X
	2				X		
180F, 180	1						X
	2		X		X	X	X
182F, 182	1		X			X	X
	2	X	X	X	X	X	X
	3	X	X	X	X	X	X
260F, 260	1		X			X	X
	2			X	X	X	X
261F, 261	1		X			X	X
	2	X	X	X	X	X	X
	3	X	X	X	X	X	X
262F, 262	1		X			X	X
	2	X	X	X	X	X	X
	3	X	X	X	X	X	X
	4	X	X	X	X	X	X

Networking choices

IMPORTANT NOTE!

- The distribution of the subscribers and external ports among both of the PABXs is up to you.
- If the master system has at least one PABX connection, all other variants for external ports are allowed.
- If the master system is operated only with multiple subscriber connections, no external port is allowed to be configured on the slave system.
- Connect a fax machine to that PABX, indicating the incoming fax number. Normally this will be the master system.
- Connect an answering machine to that PABX, signalling most of the calls. Normally this will be the master system.
- In case of operation of more than two external ISDN connections on one PABX, the installation has to be done by a registered expert.

Connection variants for networked PABXs

You may configure your PABX as master or slave system.

Configuration of EURACOM 26xF, 26x as master PABX

You can use port 2 to port 4 as ISDN port for networking. The used ISDN port has to be configured as internal interface without power feeding.

- ▶ Depending on use of the 2nd S₀ port or the 3rd/4th S₀ port, set the jumpers on the motherboard or the MS₀ module corresponding to the following illustrations.

ATTENTION!



Equipment may be damaged by electrostatic discharge. Touch a grounded, metallic part (e.g. water or radiator pipe) directly prior to the installation.

Cross link via the 2nd S₀ port

- ▶ Set the jumpers on the motherboard of your PABX corresponding to following illustration:

J1: position 1/2

J2: position 2/3

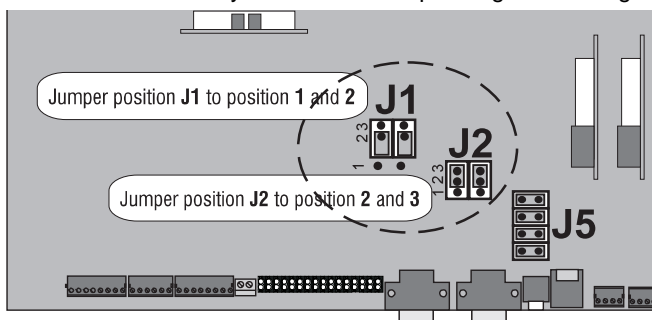

- ▶ Remove the jumpers (J5) for restricted mode

Cross link via an MS₀ module (3rd / 4th S₀ port)

- ▶ Set the jumpers on the MS₀ module corresponding to following illustration:

J3: position 1/2

J4: position 2/3

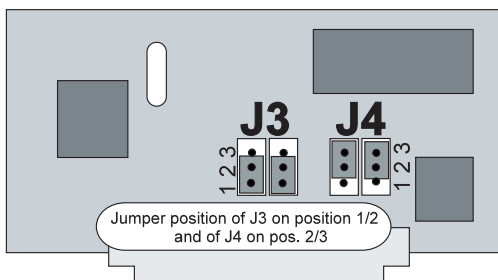

Configuration of EURACOM 26xF, 26x as slave PABX

You can use every port as cross link port. Set the corresponding jumpers on the motherboard or the MS₀ module to the operation mode external interface, if you use port 2 to 4.

ATTENTION!



Equipment may be damaged by electrostatic discharge. Touch a grounded, metallic part (e.g. water or radiator pipe) directly prior to the installation.

Cross link via the 2nd S₀ port

- Set the jumpers on the motherboard of your PABX corresponding to following illustration:

J1: position 2/3
J2: position 2/3

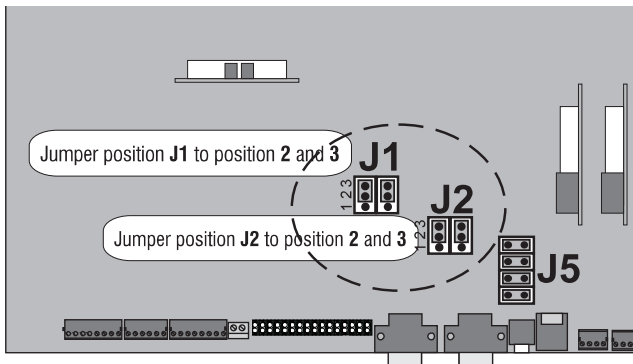

- Remove jumpers (J5) for restricted mode.

Cross link via an MS₀ module (3rd / 4th S₀ port)

- Set the jumpers on the MS₀ module corresponding to following illustration:

J3: position 2/3
J4: position 2/3

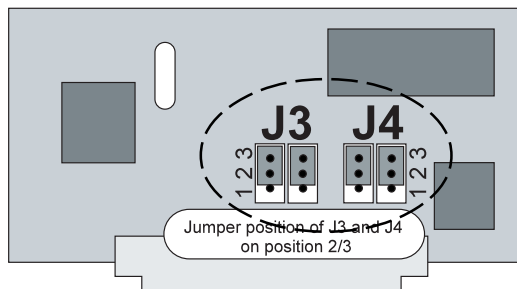

Wiring of networked PABXs

Depending on the used S_0 ports for the cross link network for wiring there are two ways to connect the PABXs. For the slave system it is possible to establish the connection via a Western plug (networking via port 1) or via the clamp connector. The following illustration is showing you, how to connect the connection cords.

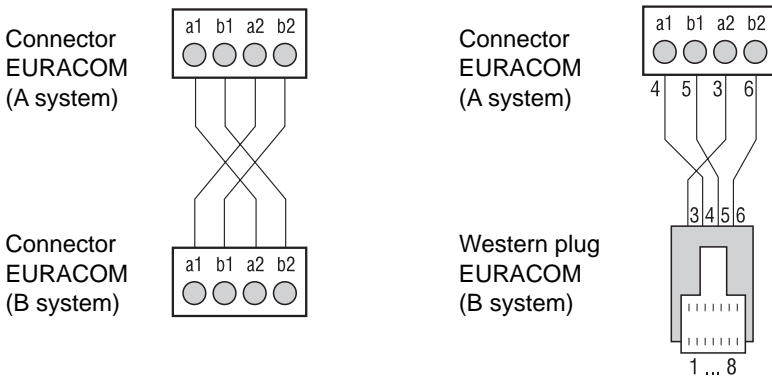

Configuration of networked PABXs

It is possible to configure networked PABXs very easily via the PC program, as this gives a better overview and your settings are more comprehensible. As both PABXs are programmed via the PC in one go, before that you have to make some settings via a telephone set.

The steps in overview:

- Define type of PABX
- Define master / slave system
- Define network port (cross linkport)
- You have to perform these steps for each of the PABXs via a telephone set.

You can look up, how to configure the networked PABXs, in the instruction manual "Configuration", page 82+.

What can be upgraded, and what is the performance?

In case the current equipment of your PABX at a later time is not enough any more, you can upgrade your EURACOM.

In that case different modules are available. If you insert in these modules into your PABX, you get further functions.

For upgrading of your PABX following modules are available:

MS₀ module

as additional S₀ interface for:

- EURACOM 260F, 260 - up to two MS₀ modules can be connected
- EURACOM 261F, 261 - one MS₀ module can be connected

MD module

for the connection of a second door intercommunication system for:

EURACOM 260F, 261F, 262F and EURACOM 260, 261, 262 - one MD module can be connected

- ▶ In order to upgrade your PABX, plug in the modules in the prepared connection places.

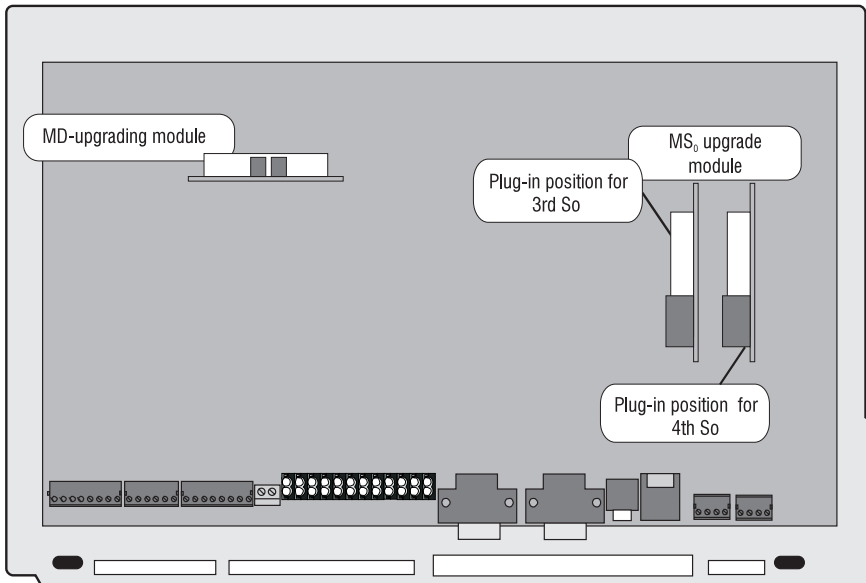

Illustration of the module plug-in positions inside the PABX

Upgrading with MS₀ module

Upgrade with MS₀ modules, if your PABX shall be equipped with one or two additional S₀ interfaces.



ATTENTION!

In any case unplug the mains before opening the equipment!



ATTENTION!

Equipment may be damaged by electrostatic discharge.

Touch a grounded, metallic part (e.g. water or radiator pipe) directly prior to the installation.

- ▶ Carefully take the MS₀ module out of the packaging. Set the jumpers in that way, that they meet the planned operating conditions.
This is where you determine how to use the MS₀ module:
 - as ISDN interface for another line access or
 - as internal ISDN bus for operation of up to eight digital terminal equipment.

In state of delivery the jumpers of the MS₀ modules are presetted for operation as internal ISDN interface. Jumpers J3 and J4 are then fixed to position 1/2 (see illustration below).

IMPORTANT NOTE!

If you want to use the MS₀ module as another line access for the ISDN basic access, you have to switch the jumpers J3 and J4 to position 2/3 (see illustration on next page). The connection to the public telecommunications network is only allowed to be performed by a registered expert.

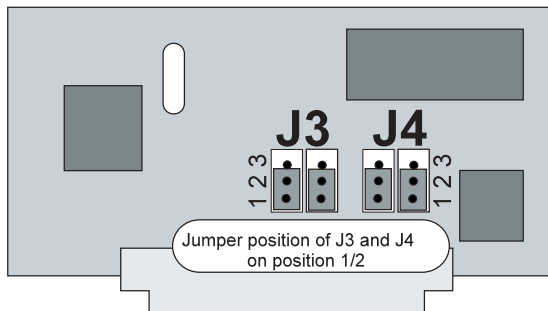

Jumper position for the operation as internal ISDN bus with power feeding

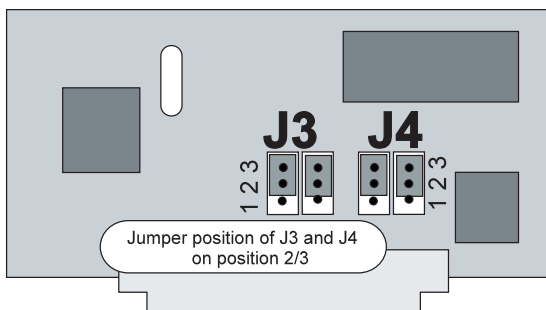

Jumper position for the operation as external ISDN interface for the basic access

- ▶ Now insert the module in the slot named “3rd S₀”. If this is occupied, choose slot “4th S₀” (--> page 31).
- ▶ Afterwards your PABX has to be configured again. More about it can be read in the instruction manual “Configuration”.

Upgrading with MD module



ATTENTION!

In any case unplug the mains before opening the equipment!



ATTENTION!

Equipment may be damaged by electrostatic discharge. Touch a grounded, metallic part (e.g. water or radiator pipe) directly prior to the installation.

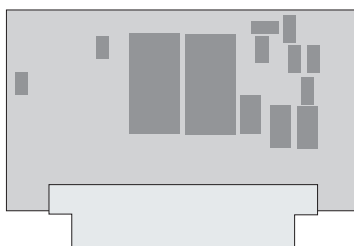

- ▶ Carefully take the MD module out of the packaging.
- ▶ Insert the module in the MD module slot (--> page 31).
- ▶ Close the cover of your PABX again.
- ▶ Now you still have to configure your DIS:
 - Assign an internal number to the DIS.
 - Determine the call distribution for your DIS.
 - Read the corresponding chapters of the instruction manual “Configuration” about it.

Technical data

Housing:

Dimensions:	360 x 252 x 92 mm (width x height x depth)
Material:	Bayblend FR 110 (flame resistant)

Weight: 2 kg

Ambient temperature:

Operation:	5°C to 40°C
Storage:	-25°C to +70°C

Air circulation: heat transfer (air cooling)

Relative humidity:

Operation at 23°C:	45% to 75%
5°C to 40°C:	25% to 80% (without moisture)
Storage:	20% to 90% (without moisture)

Nominal voltage and nominal current range:

180 - 253 V / 0,22 - 0,19 A
ELV circuit

Nominal frequency range: 50 - 60 Hz

Euro ISDN basic access:

Interface (1st S ₀):	TNV circuit ETS 300 012
Protocol:	DSS1 (ETS 300 125 and ETS 300 102)
Operation mode:	Multiple subscriber mode (point-to-multipoint) Transmission distance 100 - 150 m or PABX connection (point-to-point) Transmission distance 1000 m
Connection:	WE 8/4 (RJ 45) IAE plug

Internal analogue terminal interface:

	TNV circuit
Dialling procedure:	DTMF: flash key recognition: 80 msec hook flash: 150 - 900 msec
or:	Pulse: earth key substitution with dialling of number "1" or hook flash
Power feeding:	34 V +4% / -7% (current limited to max. 34 mA)
Ringling voltage:	33 to 46 VAC on 1,8kΩ ± 1 μF per port Charge pulse 16 kHz, -15 dB on Zr (950 mV)

Transmission distance:	2 x 200 Ω approx. 1,4 km with wire dia 0,4 mm approx. 3,1 km with wire dia 0,6 mm
Impedance:	Zr = 220 Ω + 820 Ω parallel 115 nF, symmetrical
Symmetry:	> 55 dB (300 Hz - 3400 Hz)
Level of tones:	-14 dB on Zr (950 mV)
Connection EURACOM 26x:	plug-in screw connection clamp
Connection EURACOM 26xF:	cage clamp
External music on hold interface:	SELV circuit
Input impedance:	100 kΩ, asymmetrical
Input voltage:	0,6 Vss
Connection:	3,5 mm jack
Max. cable length:	3 m
Printer / PC interface:	SELV circuit, RS 232 C
Connection:	9-pin D Sub socket
Connection cable:	shielded
Max. cable length:	3 m
Transmission rates:	2400, 4800, 9600 bit/sec no parity bit 1 stop bit
Door intercom system interface (DIS):	SELV circuit according to FTZ 123 D 12
Max. switch performance:	(TS / TO relay) 28 VAC / 400 mA or 24 VDC / 300 mA potential free
Connection:	8-pin, plug-in screw connection clamp
Control elements:	SELV circuit
1 sensor:	5 V surveillance loop
2 actor relays:	28 VAC / 400 mA or 24 VDC / 300 mA potential free
Connection:	6-pin, plug-in screw connection clamp

Technical data

2nd S₀ interface:

Internal:

Power feeding:	according to ETS 300 012 41 V +/- 5% (max. 100 mA)
Protocol:	DSS1 (ETS 300 125 and ETS 300 102)
Operation mode:	Multiple subscriber connection (point-to-multipoint)

Transmission distance 100 - 150 m
or

PABX connection (point-to-point)

Transmission distance 1000 m

Network access:

Protocol:	ETS 300 012 DSS1 (ETS 300 125 and ETS 300 102)
Operation mode:	Multiple subscriber connection (point-to-multi point)

Transmission distance 100 - 150 m
or

PABX connection (point-to-point)

Transmission distance 1000 m

Connection EURACOM 26x:

4-pin plug-in screw connection clamp

Connection EURACOM 26xF:

cage clamp

System 261F, 261 and 262F, 262 with variable digital Euro ISDN ports

Interface (3rd S₀ and 4th S₀):

MS₀ module

SELV circuit

Internal:

Power feeding:	according to ETS 300 012 41 V +/- 5% (max. 100 mA)
Protocol:	DSS1 (ETS 300 125 and ETS 300 102)
Operation mode:	Multiple subscriber connection (point-to-multi point)

Transmission distance 100 - 150 m
or

PABX connection (point-to-point)

Transmission distance 1000 m

Network access:

Protocol:	ETS 300 012 DSS1 (ETS 300 125 and ETS 300 102)
Operation mode:	Multiple subscriber connection (point-to-multi point)

Transmission distance 100 - 150 m
or

PABX connection (point-to-point)

Transmission distance 1000 m

Connection:

4-pin plug-in screw connection clamp